

# Finding Your Way around the System

---

You've bought your computer and taken everything out of the box. You may be asking yourself, "OK, now what do I do?" This chapter explains how to set up your computer, gives you tips on working comfortably and takes you on a tour of the computer's features.

## Make Sure You Have Everything

Your computer comes with everything you need to get up and running quickly. However, before you rush off, it's a good idea to make sure you received everything you were supposed to. This information is listed on the Quick Start Card at the top of the box.

If any items are missing or damaged, notify your dealer immediately. For additional help, contact Toshiba as described in "If You Need Further Assistance" on page 359.

## Select a Place To Work

Your Tecra 740CDT computer is portable, designed to be used in a variety of circumstances and locations. However, by giving some thought to your work environment, you can protect the computer and make your work hours more comfortable.

### Keep the Computer Comfortable

Use a flat surface with enough room to operate comfortably. If you're planning to use a printer or other external device, make sure there's enough space for it as well.

To keep your computer in prime operating condition, make sure your work area is free from:

- ❖ Dust, moisture and direct sunlight.
- ❖ Liquids and corrosive chemicals.



*Don't spill liquids into the computer. If you spill a liquid into the keyboard, turn the computer off, unplug it from the AC power source, and let it dry completely before turning it on again.*

*If the computer does not operate correctly after you turn it back on, contact a Toshiba authorized service provider.*

---

- ❖ Objects that generate a strong electromagnetic field, such as stereo speakers or speakerphones.
- ❖ Rapid changes in temperature or humidity and sources of temperature changes such as air conditioner vents or heaters.
- ❖ Extreme heat, cold or humidity. Operate the computer within a temperature range of 40 to 95 degrees Fahrenheit (5 to 35 degrees Celsius) and 20% to 80% non-condensing humidity.

---

## Keep Yourself Comfortable

Strain and stress injuries are becoming more common as people spend more time using their computers. However, with a little care and proper use of the equipment, you can work comfortably throughout the day.



---

*Using the computer keyboard incorrectly can result in discomfort and possible injury. If your hands, wrists, and/or arms bother you while typing, discontinue using the computer and rest. If discomfort persists, consult a physician.*

---

In addition to the hints provided in the following sections, there are a number of books available on ergonomics, repetitive strain injury, and repetitive stress syndrome.

## Placement of the Computer

Proper placement of the computer and external devices is important to avoid stress-related injuries:

- ❖ Place the computer on a flat surface at a comfortable height and distance. Your arms and hands should be in a relaxed position with your forearms parallel to the floor. The top of the screen should be no higher than eye level.
- ❖ Maintain good posture with your body relaxed and your weight distributed evenly. You should be able to type without twisting your torso or neck, and see the display panel without slouching.
- ❖ Adjust the display panel to avoid glare.
- ❖ If you use a paper holder, set it at about the same height and distance as the computer.

## Seating and Posture

Proper seating is one of the primary factors in reducing work strain. Some people find a backless chair more comfortable than a conventional chair. Whichever type you choose, refer to the following guidelines to adjust your chair for maximum computing comfort.

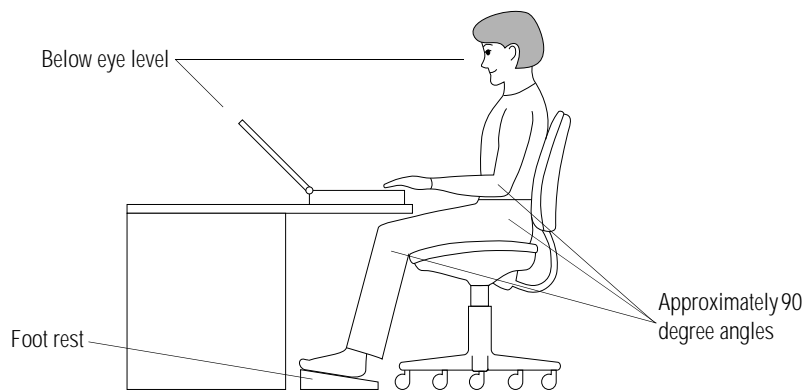

*Correct posture and positioning of the computer*

- ❖ Position your chair so the keyboard is at or slightly below the level of your elbow. You should be able to type comfortably with your shoulders relaxed.

If you are using a conventional chair:

- ❖ Your knees should be slightly higher than your hips. If necessary, use a foot rest to raise the level of your knees and ease the pressure on the back of your thighs.
- ❖ Adjust the back of your chair so it supports the lower curve of your spine. If necessary, use a cushion to provide extra back support. Lower back support cushions are available at many office supply stores.
- ❖ Sit with your back straight so that your knees, hips and elbows form approximately 90 degree angles when you work. Do not slump forward or lean back too far.

## Lighting

Proper lighting can improve the legibility of the display and reduce eye strain.

- ❖ Position the display panel so that sunlight or bright indoor lighting does not reflect off the screen. Use tinted windows or shades to reduce glare.
- ❖ Avoid placing your computer in front of a bright light that could shine directly in your eyes.
- ❖ If possible, use soft, indirect lighting in your computer work area.

## Arms and Wrists

- ❖ Avoid bending, arching, or angling your wrists. Keep them in a relaxed, neutral position while typing.
- ❖ Exercise your hands, wrists and arms to improve circulation.

## Work Habits

The key to avoiding discomfort or injury from repetitive strain is to vary your activities. If possible, schedule a variety of tasks into your work day. Finding ways to break up the routine can reduce stress and improve your efficiency.

- ❖ Take frequent breaks to change position, stretch your muscles, and relieve your eyes.
- ❖ Avoid performing repetitive activities for prolonged periods of time. Vary activities from one task to another.
- ❖ Focusing your eyes on your computer screen for long periods of time can cause eye strain. Look away from the computer frequently and focus your eyes on a distant object.

## Find Out Where Everything's Located

If you've never used a notebook computer before, you're probably wondering how an entire computer can fit into so small a case. The next few pages take you on a guided tour of the computer and its components.

Rather than reading through this section, you may prefer to use it as a reference as you move through the remainder of the guide and need to locate specific parts of the computer. This information is also available in the electronic form of this guide, described in "Using the Electronic Guide" on page 42.

Don't worry if you don't know what some parts of the computer do. Some items in this tour are for more advanced computing functions that you may want to use as your computing needs and skills increase.

### The Front with the Display Closed

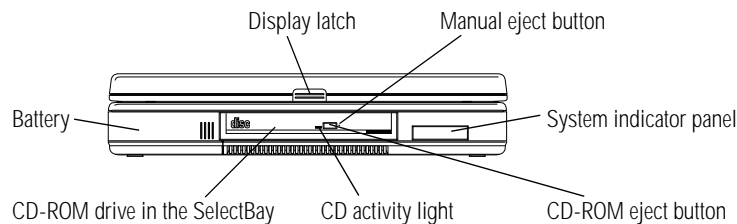

*The front with the display closed*

Pressing the **display latch** opens the computer's display panel. For more information, see "Open the Display" on page 28.



The computer's removable **battery** powers the computer when you're away from a convenient power source. For more information, see "Changing Batteries" on page 151.

The **SelectBay** can hold a **CD-ROM drive** module, a diskette drive module, or a hard disk drive module. An external diskette drive case holds the diskette drive module when you install the CD-ROM drive module or the hard disk drive module, letting you use the diskette drive when it's not installed in the SelectBay. For

more information about the SelectBay, see “Swapping SelectBay Modules” on page 114.

Pressing the **CD-ROM eject button** opens the 5.25-inch CD-ROM drive in the SelectBay when the computer’s power is on.

The **CD activity light** glows when the system is accessing a disc in the CD-ROM drive.



*Do not open the CD-ROM drive if the CD activity light is on.*

The **manual eject button**, in the small hole next to the CD-ROM eject button, opens the CD-ROM drive when the computer’s power is off. Use a straightened paper clip or other slender object to press this button.

The lights on the **system indicator panel** provide information about various system functions. See “The System Indicator Panel” on page 13 for a description of the panel lights.

## The Left Side

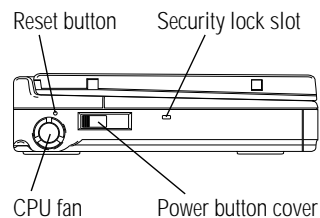

*The left side*

The **CPU fan** provides extra cooling when necessary to help keep the computer’s Pentium processor from overheating. This lets the processor keep performing at its maximum speed.



*To prevent possible overheating of the Pentium processor, make sure you don't block the fan vent.*



Pressing the **reset button** restarts the computer. Use this button if all other attempts at restarting the computer have failed.



*Don't use a pencil to press the reset button. Pencil lead can break off inside the computer and damage it. Instead, use a slender object such as a straightened paper clip.*



The **power button cover** protects the power button, which turns the computer on and off. Slide this cover toward the front of the computer to reveal the power button. For more information, see “Turn the Computer On” on page 30.



Attaching a special cable to the **security lock slot** lets you anchor your computer to your desk or other large, heavy object. For more information, see “Applying Physical Restraints” on page 256.

## The Back

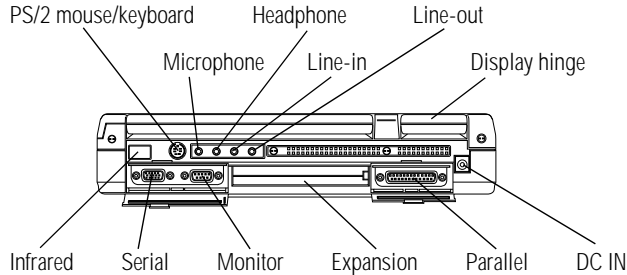

*The back*



The **PS/2 mouse/keyboard port** lets you connect an optional PS/2 mouse or keyboard. For more information, see “Using a PS/2 Mouse” on page 242 or “Using an External Keyboard” on page 240.



The 3.5 mm mini **line-in jack** lets you connect a external stereo device for audio input.



The 3.5 mm mini **line-out jack** lets you connect a external stereo device for audio output.





The 3.5 mm **microphone jack** lets you connect an external monaural microphone or other audio input device. Connecting a microphone or other device to this jack disables the internal microphone automatically.



The 3.5 mm **headphone jack** lets you connect stereo headphones or other audio output devices. Connecting headphones or other devices to this jack automatically disables the internal speaker.



The serial **infrared port** allows wireless communication with a computer or other device, such as a printer, that has an infrared port.

The **display hinges** attach the display panel to the computer.



The **monitor port** allows you to connect an external monitor. For more information, see “Using an External Monitor” on page 237.



The **serial port** lets you connect a serial mouse, printer or other serial device.



The **expansion port** allows you to connect the optional NoteDock II Enhanced Port Replicator or Desk Station V Plus. These devices provide additional expansion capability. For more information, see “The Desk Station V Plus” on page 245 and “The NoteDock II Enhanced Port Replicator” on page 250.



*Keep foreign objects away from this port. Pins and other small objects can slip inside the port and damage computer circuitry.*



The **parallel port** lets you connect a printer or other parallel device. For more information, see “Connecting a Parallel Printer” on page 26.



The **DC IN socket** is where you plug in the AC adapter. For more information, see “Connect to a Power Source” on page 17.

## The Right Side

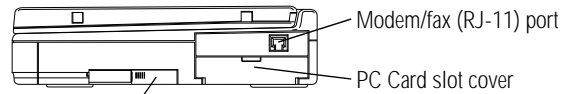

External diskette drive port cover

### *The right side*



The **external diskette drive port cover** protects the external diskette drive port. You use this port to connect the external 3 1/2-inch diskette drive when the another SelectBay module is installed in the computer's SelectBay.



The **PC Card slot cover** protects the PC Card slot, which lets you install up to two Type I or Type II PCMCIA-compatible PC Cards, or one Type III PC Card. For more information, see "Little Cards that Do Big Things" on page 193.



The **modem/fax (RJ-11) port** lets you connect the computer's internal modem directly to a telephone line.

## The Underside

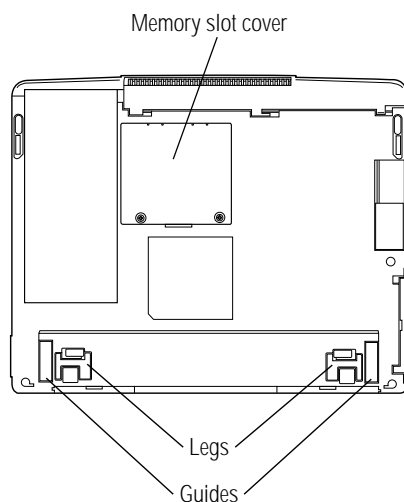

### *The underside*



The **memory slot cover** protects a slot for adding extra memory to your computer. For more information, see “Adding Memory (Optional)” on page 19.

Releasing the **legs** lets you raise the back of the computer, providing an alternate typing angle.

The **guides** help align the optional Desk Station V Plus or NoteDock II Enhanced Port Replicator. For more information, see “The Desk Station V Plus” on page 245 and “The NoteDock II Enhanced Port Replicator” on page 250.

## The Front with the Display Open

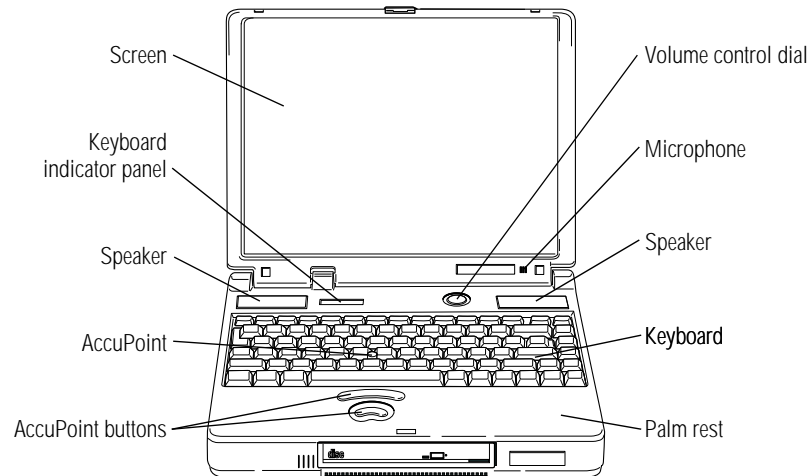

*The front with the display open*

The computer's **screen** is a liquid crystal display (LCD) that provides clear, sharp images.

The **AccuPoint** pointing device combines the function of a mouse with the convenience of never having to remove your hands from the keyboard. For more information, see “Using the AccuPoint Pointing Device” on page 29.

The **AccuPoint buttons** work with the AccuPoint. The larger (primary) button acts as the left button on a mouse. The smaller (secondary) button acts as the right mouse button. For more information, see “Using the AccuPoint Pointing Device” on page 29.

The 82-key **keyboard** provides all the functionality of a full-sized 101-key keyboard. For more information, see “How to Use the Keyboard” on page 90.

The built-in **microphone** lets you record sounds and speak through the telephony modem.

The **volume control dial** lets you adjust the loudness of the system speakers.

The **speakers** let you hear system alarms and sounds associated with your software.

The lights on the **keyboard indicator panel** provide information about various system functions. See “The Keyboard Indicator Panel” on page 14 for a description of the panel lights.

The **palm rest** makes typing more comfortable.

## The Indicator Panels

Two panels of lights display the current state of your system. This section describes the two indicator panels.

### The System Indicator Panel

This panel is located on the front of the computer.

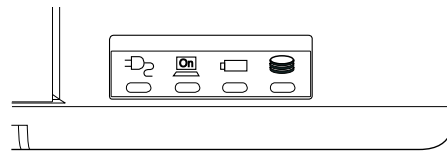

*The system indicator panel*



The AC power light glows when the computer is connected to an external power source. For more information, see “Connect to a Power Source” on page 17.



The on/off light glows green when the computer is on.



The battery light indicates the current battery charge. For more information, see “Monitoring Battery Power” on page 142.



The disk light indicates the hard disk or diskette drive module is currently in use.



*Do not turn the computer off if the disk light is on.*

## The Keyboard Indicator Panel

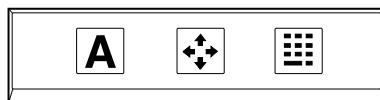

*The keyboard indicator panel*



The caps lock light glows when you press the Caps Lock key. When this light is on, pressing a letter key on the keyboard produces an upper-case (capital) letter. For more information, see “The Character Keys” on page 90.



The cursor control mode light glows when the cursor control overlay is on. When the overlay is on, pressing an overlay key moves the cursor as shown by the white arrow printed on the left front of the key instead of the letter printed on the top of the key. For more information, see “The Cursor Control Overlay” on page 305.



The numlock light glows when the numeric overlay is on. When the overlay is on, pressing an overlay key produces the white number printed on the right front of the key instead of the letter printed on the top of the key. For more information, see “Typing Numbers” on page 91.



# Let's Start at the Very Beginning

---

Now that you know where everything is, it's time to get to work. This chapter provides easy-to-follow steps for getting the computer up and running.

## Connect to a Power Source

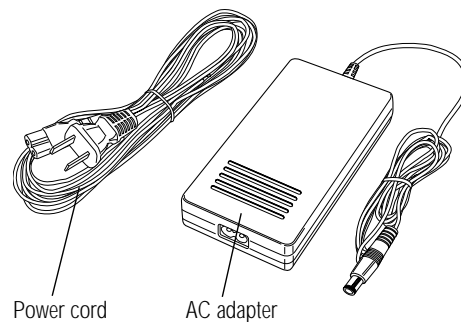

*The AC adapter and power cord*

Before you can use the battery to power the computer, you must charge it. Just plug the computer into a live power outlet using the **AC adapter** and **power cord**. Leave the computer plugged in for four hours with the computer's power turned off, or five and a half



to twelve and a half hours with the power on. Soon the battery will be completely charged and ready to power the computer.



*Once the battery is charged for the first time, don't leave the computer plugged in and turned off for more than a few hours at a time.*

To connect your computer to a power source, follow these steps:

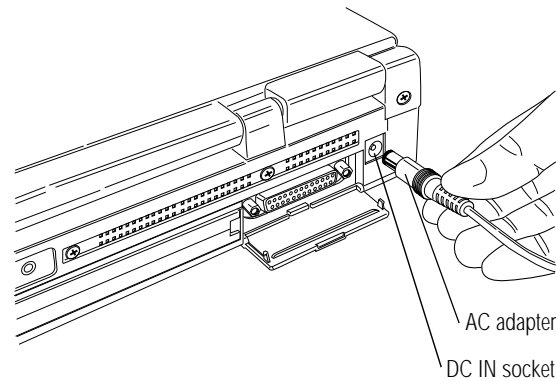

#### *Connecting the AC adapter*

- 1 Connect the AC adapter to the DC IN socket on the back of the computer.**
- 2 Connect the power cord to the AC adapter.**
- 3 Connect the other end of the power cable to a live wall outlet.**

The AC power light on the front of the computer glows green.

---

## Adding Memory (Optional)

Your computer comes with enough memory to run most of today's popular applications. However, you may want to increase the computer's memory. With additional memory, the computer:

- ❖ Can run more programs and open more documents at the same time.
- ❖ Runs Windows 95 and Windows applications faster.

By installing extra memory now, you'll be able to operate your computer at its maximum capacity from the start. Of course, you can always come back to this section if you decide to add memory later.

### Sizes of Memory Modules

Additional memory is easy to install. Memory modules, available from your dealer, come in the following sizes:

<i>Memory Module Size</i>	<i>Total Memory Installed</i>
No module installed	16MB
8MB card installed	24MB
16MB card installed	32MB
32MB card installed	48MB
64MB card installed	80MB
128MB card installed	144MB

## Install the Memory Module

The memory module installs into the memory expansion slot on the bottom of the computer. You'll need a small Phillips screwdriver for this procedure.

- 1 Press Fn + F3 to display the Resume Mode pop-up window.**
- 2 If Resume Mode is on, hold Fn and press F3 until Boot Mode is selected.**
- 3 Release Fn.**

The Resume Mode pop-up window disappears.

- 4 If you are adding memory after you have used the computer, click Start, then click Shut Down.**

If you haven't used the computer yet, skip to step 6.

Windows 95 displays the Shut Down Windows dialog box.

- 5 Select Shut down the computer, then click Yes.**

Windows 95 shuts down and turns the computer off automatically.

- 6 Unplug the computer.**



*Installing a memory module with the computer's power on may damage the computer, the module or both.*

---

- 7 Close the display and remove any cables you may have connected.**

If you're installing additional memory before using the computer, you haven't connected any cables yet.

- 8 Turn the computer upside down.**
- 9 Remove the battery pack, following steps 4 and 5 in "Changing Batteries" on page 151.**

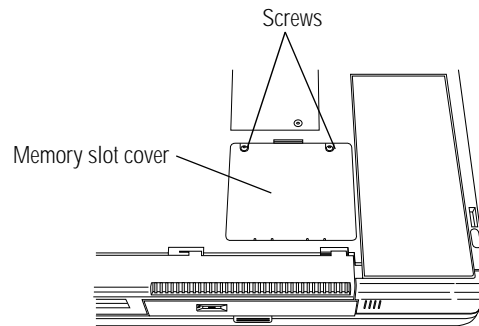

*Locating the screws*

**10 Use a small Phillips screwdriver to remove the two screws that secure the memory slot cover.**

**11 Remove the memory slot cover.**



*Static electricity can damage the memory module. Before you handle the module, touch a grounded metal surface to discharge any static electricity you may have built up.*

*To avoid damaging the memory module, be careful not to touch its pin connector (on the side you insert into the computer).*

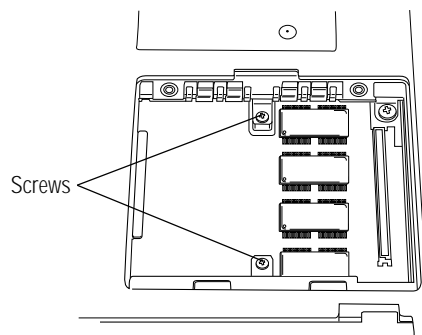

*Removing the screws from the brace*

**12 Remove the two screws from the brace at the center of the slot.**

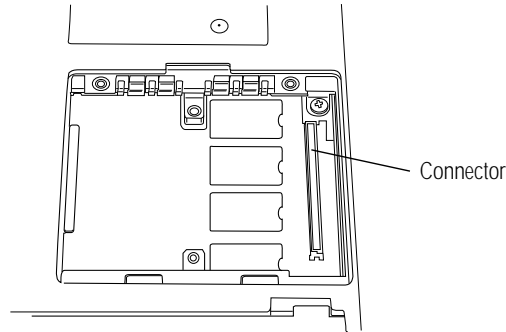

*Inserting a memory module*

- 13 Carefully place the module in the slot with the card connector facing down and aligned with the slot's connector.**
- 14 Gently press the module down onto the connector.**

Do not force the module into position.
- 15 Secure the memory module by replacing the two screws you removed in step 12.**
- 16 Replace the memory slot cover.**
- 17 Replace the screws you removed in step 10.**
- 18 Replace the battery pack.**
- 19 Turn the computer over.**

When you turn your computer on, it recognizes the additional memory automatically.

---

## Removing the Memory Module

If you ever need to remove the memory module, follow these steps:

- 1 Complete steps 1 through 11 in the previous section, “Install the Memory Module” to turn the computer off and remove the memory slot cover.**
- 2 Remove the two screws securing the memory module in the slot.**
- 3 Remove the memory module.**
- 4 Replace the two screws you removed in step 3.**
- 5 Complete steps 16 through 19 in the previous section, “Install the Memory Module” to replace the memory slot cover and return your computer to its original state.**

## Using the External Diskette Drive

The computer's external 3 1/2-inch diskette drive is useful for installing programs on the hard disk, exchanging information with other systems, and making backup copies of the files stored on your hard disk.

If you prefer, you can remove the CD-ROM drive and install the diskette drive into the SelectBay. See “Swapping SelectBay Modules” on page 114 for more information.



NOTE

*The external diskette drive case works with the diskette drive only. The CD-ROM drive only works when installed in the SelectBay.*

---

## Connecting the External Diskette Drive

To connect the external diskette drive to the computer, follow these steps:

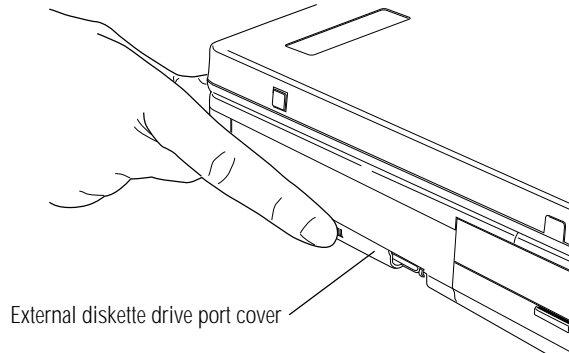

*Opening the external diskette drive port cover*

- 1 Slide open the external diskette drive port cover, located on the right side of the computer.**

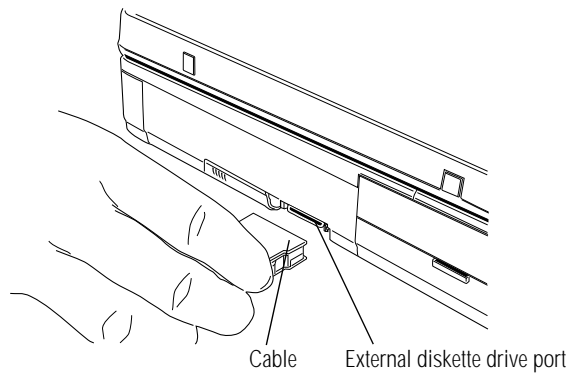

*Connecting the external diskette drive*

- 2 Attach the cable from the external diskette drive to the external diskette drive port.**



*You may attach the external diskette drive with the computer on or off. If you attempt to use the diskette drive and it is not attached to the computer, the computer displays an error message.*

The computer automatically recognizes the external diskette drive and calls it the A drive.

## Disconnecting the External Diskette Drive

To disconnect the external diskette drive from the computer, press the cable connector buttons (on each side of the cable connector) and gently pull the connector out of the external diskette drive port.



*If you try to access a diskette in the external diskette drive after disconnecting the drive, you will get a disk error message.*

## Inserting and Removing Diskettes

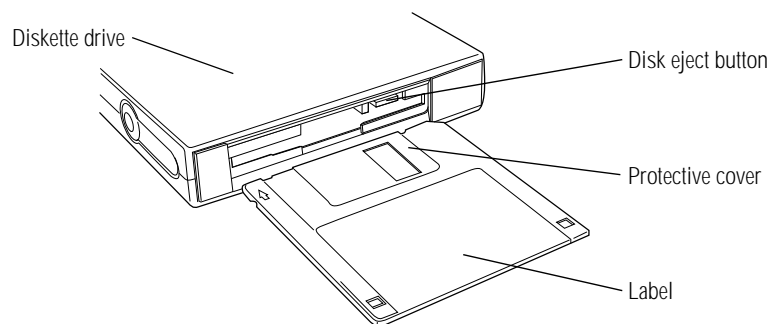

### *Inserting a diskette*

A protective flap inside the disk insertion slot automatically retracts when you insert a diskette.



The preceding illustration shows the correct insertion procedure. Make sure your fingers are touching the **label** and that the **protective cover** points toward the **diskette drive**. When the diskette is almost completely in the drive, you will feel a slight resistance. Push the diskette gently into place. When the diskette is securely in the drive, the **disk eject button** pops out.

Push the disk eject button to remove a diskette from the drive.

## Connecting a Parallel Printer

If you already have a printer, now is a great time to connect it to the computer. If you don't have a printer or don't wish to connect it yet, don't worry. You can always connect one later.

The most common type of printer connection is through a parallel printer cable. You may have received this cable when you purchased your printer. Otherwise, printer cables are available from your dealer and at most computer and electronics stores.



NOTE

*If your printer is ECP compatible and you wish to take advantage of high speed printing, you'll need to connect the printer to the computer using an IEEE 1284 printer cable.*

To connect the printer to the computer, follow these steps:

- 1 Turn the computer's power off.**
- 2 Identify the two ends of the printer cable.**

One end connects to the computer. The other end connects to the printer.

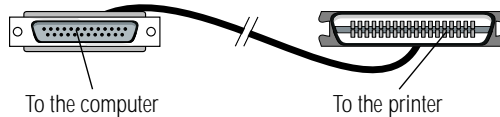

*Identifying the ends of the printer cable*

- 3 With the printer off, connect the printer cable to your printer.**

If you're unsure how to do this, your printer's documentation will tell you.

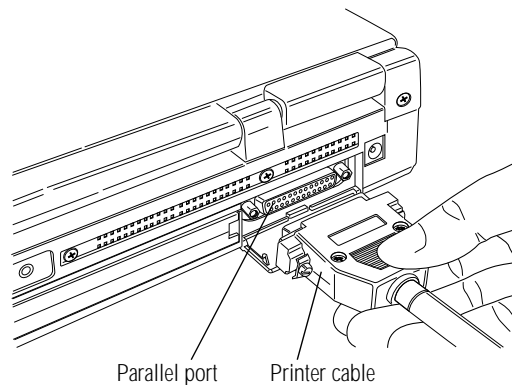

*Connecting the printer cable to the parallel port*

- 4 **Connect the printer cable to the computer's parallel port.**
- 5 **Plug the printer's power cable into a live AC outlet.**

## Using the Keyboard Legs

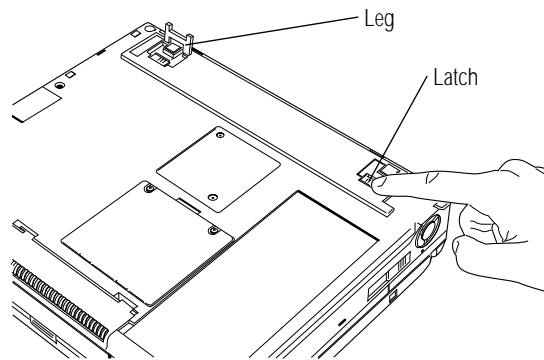

*Releasing the legs*

Before you open the display, turn the computer over and locate the keyboard **legs**. These **legs** unfold when you press the leg **latches**, allowing you to adjust the keyboard angle for maximum typing comfort. Once you've unfolded and folded the legs a few times, you should be able to do so without turning the computer over.

## Open the Display

The final step before you turn your computer on is to open the display.

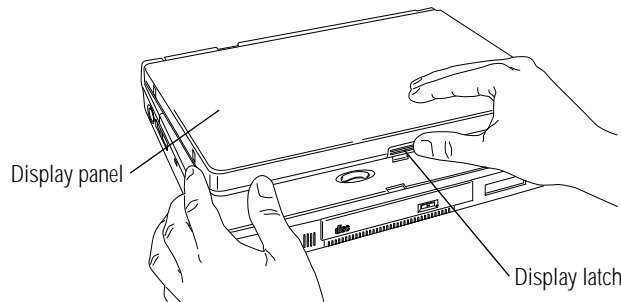

*Opening the display*

- 1 Locate the display latch on the front of the computer.**
- 2 Press the display latch and lift the display panel.**
- 3 Adjust the display panel to a comfortable viewing angle.**



*To avoid damaging the display panel, be careful when opening and closing the panel. Do not force it beyond the point where it moves easily, and never lift the computer by the display panel.*

## Fill In Your Registration Card and Mail It

Take a few minutes now to fill in and mail your product registration card. The card was on the keyboard of your computer when you first opened the display panel. Sending in your product registration card lets Toshiba keep you up to date with information about new products and upgrades.

Registering your computer also extends your Toshiba warranty world-wide at no charge to you. See the registration card and warranty information for details about the warranty options available from Toshiba.

## Using the AccuPoint Pointing Device

The computer's AccuPoint pointing device enables you to move the cursor and to select items on the screen. If you're familiar with desktop computers, you may have used a mouse or trackball for this purpose. The AccuPoint provides all the functionality of a mouse or trackball without your hands ever leaving the keyboard.

If you would rather use a mouse or trackball, you can connect one to the serial port or PS/2 mouse/keyboard port.

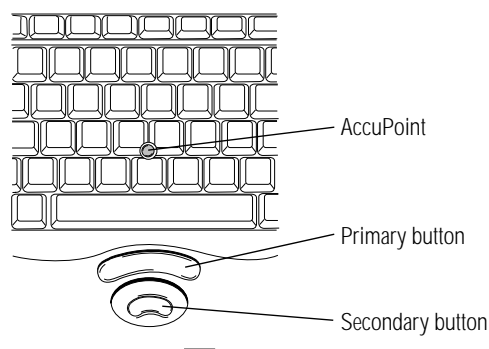

*The AccuPoint pointing device*

To move the cursor, gently push the **AccuPoint** in the direction you want the cursor to move. Pushing harder on the AccuPoint moves the cursor faster.

When a step instructs you to click or choose an item, move the cursor to the item, then press and release the **primary button**. To double-click, click the primary button twice in rapid succession. The primary button corresponds to the left button on a mouse.

The function of the **secondary button** depends on the program you are using. It corresponds to the right button on a mouse. Check your programs' documentation to find whether it uses the right mouse button.

## Turn the Computer On

Finally, the preparation is over. It's time to turn the computer on and get to work. To turn the computer on, follow these steps:

- 1 **Make sure there's no diskette in the diskette drive.**
- 2 **If you have a printer connected to your computer, turn the printer on and wait until the printer is ready (on line).**
- 3 **Locate the on/off light on the system indicator panel.**

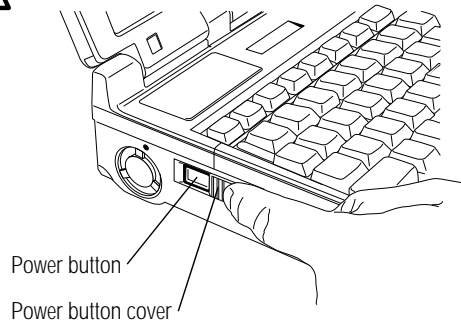

*Opening the power button cover*

- 4 **Slide the power button cover toward the front of the computer, revealing the power button.**

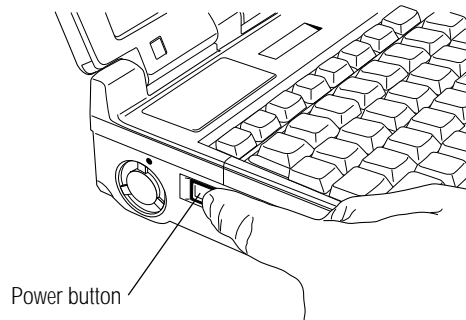

*Turning the power on*

- 5 Press and hold the power button on the left side of the computer until the on/off light turns on (about one second).**



*When you turn the computer for the first time, do not turn the power off again until the operating system has loaded completely.*

## When You Turn the Computer On the First Time

The first time you turn the computer on, the system displays the Welcome to Windows 95 Setup screen.

Complete the following steps to select your operating system:

- 1 In the Welcome to Windows 95 Setup screen, click Next. (Use the AccuPoint to position the pointer over the Next button, then press the primary button.)**

Setup displays the Windows Version screen.

---

**2 Choose your operating system:**

---



*Please consider your choice carefully. Once you choose Windows 95 or Windows for Workgroups, the setup program automatically (and permanently) deletes the unselected operating system from your system.*

*The Noteworthy<sup>®</sup> Business Video Phone with Intel<sup>®</sup> ProShare<sup>®</sup> Technology, provided with your Tecra 740CDT, is specifically designed to work with Windows 95. If you choose Windows for Workgroups as your operating system, you will not be able to use this video conferencing package.*

---

- ❖ To choose Windows 95 (the default), click Next.
- ❖ To choose Windows for Workgroups, click Change. Setup displays the Operating System Choice screen. Click “No, I want to install MS-DOS 6.22 and Microsoft Windows for Workgroups 3.1,” then click OK.

If you chose Windows for Workgroups, follow the instructions in the next section, “Finish the Windows for Workgroups Setup Procedure” to complete the setup procedure. If you chose Windows 95, follow the instructions in “Finish the Windows 95 Setup Procedure” on page 33 to complete the setup procedure.

### **Finish the Windows for Workgroups Setup Procedure**

After you choose Windows for Workgroups as your operating system, Windows Setup displays the License Agreement screen.

**1 Read the license agreement, then click the button next to “I accept.”**

Setup displays a Setup Wizard screen and installs the devices it found on your system. Once it has installed the devices, Setup displays the Finishing Setup screen, prompting you to restart your computer.

**2 Click Finish to restart the computer.**

The system restarts, loads Windows for Workgroups, and displays a Windows Setup screen, prompting you for your name, company, and product number.

**3 Type your name and company in the appropriate fields. You may leave the product number field blank, or type in the Windows 95 Certificate of Authenticity number.**

**4 Click Continue.**

Setup prompts you to verify the information you just entered.

**5 If the information is correct, click OK.**

To change any of the information displayed, click Change.

Setup displays the Printer Installation screen.

**6 If you have a printer, use the ↑ and ↓ keys to select your printer from the list and click Install.**

If you don't have a printer, choose No Printer from the list and click Install.

Setup prompts you to select a printer port.

**7 Set the port to LPT1: for a parallel printer (or COM1: for a serial printer) and click Install.**

The computer restarts and reloads Windows for Workgroups.

## Finish the Windows 95 Setup Procedure

After you choose Windows 95 as your operating system, Windows Setup displays a Windows 95 Setup Wizard and installs the devices it found on your system. Once it has installed the devices, Setup displays the Finishing Setup screen, prompting you to restart your computer.

**1 Click Finish to restart the computer.**

The computer restarts and loads Windows 95.

Setup displays the User Information screen.



- 2 Type your name and company in the appropriate fields, then click Next.**

Setup displays the License of Windows 95 screen.

- 3 Read the license agreement, then click the button next to “I accept the agreement.”**

- 4 Click Next.**

Setup displays the Certificate of Authenticity screen.

- 5 Type in the number from the Certificate of Authenticity, affixed to the Windows 95 manual that came with your computer, then click Next.**

Setup displays the Start Wizard screen.

- 6 Click Finish.**

## Select Date/Time Properties

As Setup continues, Windows 95 displays the Date/Time Properties dialog box. This dialog box has two tabs. Click on a tab to bring it to the front.

- 1 On the Time Zone tab, select your time zone by clicking the up and down arrow keys.**
- 2 On the Date and Time tab, set the correct date and time, if necessary.**
- 3 When you've finished, click Close.**

Setup starts the Add Printer Wizard.

## Set Up Windows 95 to Work With Your Printer

If you already have a printer, click Next when the system prompts you to set up your printer. If you plan to purchase a printer later, click Cancel now and see “Setting Up Windows 95 to Work with Your Printer” on page 94 when you're ready to connect it.

To set up Windows 95 to work with your printer now, follow these steps:

- 1 When Windows 95 opens the Printers dialog box, scroll through the lists of manufacturers and printers until you find yours.**

If your printer is not listed, it probably came with its own diskette. Insert this diskette into the diskette drive and click Have Disk. When Windows 95 displays the Install From Disk dialog box, click OK.

- 2 Select your printer and click Next.**
- 3 Set the port to LPT1: for a parallel printer (or COM1: for a serial printer) and click Next.**
- 4 Type in a new name for your printer or accept the default and click Next.**
- 5 If your printer is connected and turned on, click Finish to print a test page.**

To finish the setup procedure without printing a test page, click No, then Finish.

## Complete the Initial Startup Procedure

Windows 95 completes its setup procedure and displays the Welcome to Windows 95 screen. This screen provides the following options:

- ❖ The Windows 95 Tour gives you a brief overview of Windows 95. For a more complete introduction, see “Getting to Know Windows 95” on page 53.
- ❖ Select What’s New for answers to common questions about Windows 95.
- ❖ Online Registration lets you register Windows 95 with Microsoft.

Once you've finished looking at any or all of the above options, click Close to finish the initial startup procedure and open Windows 95.



To finish setting up your system, double-click the stop sign icon on the desktop. Follow the instructions on the screen to customize and register your computer.

## How to Use this Guide with Windows for Workgroups

The instructions in this guide are specific to Windows 95. If you chose Windows for Workgroups, a number of things are different, including:

- ❖ The tutorial provided in “Getting to Know Windows 95” on page 53 refers to Windows 95 only.
- ❖ The instructions in this guide for starting the MaxTime Control Panel, the Toshiba System Control Panel, and Fn-esse are for Windows 95 only. You can access the equivalent programs in Windows for Workgroups (MaxTime, Hardware Setup, and Fn-esse) by double-clicking their icons in the Toshiba Utilities group in Program Manager.
- ❖ Windows for Workgroups does not include a Suspend command. Use Resume Mode instead.
- ❖ Windows 95 contains the files your computer needs to communicate with optional PCMCIA-compatible PC Cards. If you're using Windows for Workgroups, use the supplied Card-Wizard program for your optional PC Cards.
- ❖ The steps in “Changing the Display Mode” on page 308 are for Windows 95. To change the display mode in Windows for Workgroups, double-click the Chips CPL icon in the Control Panel.

---

## Create Master Diskettes or Purchase the CD-ROM

When you buy a program at a computer store, you receive a set of program diskettes or a CD-ROM containing the files necessary to install the program on your computer's hard disk. You can also use the files to reinstall your software if necessary.

However, your computer comes with a number of programs, such as Microsoft Windows 95, already installed on the hard disk. If one or more of these programs is ever damaged or deleted, you'll need program files to reinstall it.

You must buy blank diskettes and run Microsoft's Create System Disks program to make a set of Microsoft Windows 95 diskettes.

There are two ways of obtaining program files for your other pre-installed software (excluding Microsoft Windows 95):

- ❖ Buy blank diskettes and run Toshiba's Master Disk Creator program.
- ❖ Purchase the Toshiba drivers/utilities on CD-ROM from Toshiba, using the order form that came with your computer.

If you chose Windows for Workgroups, use Master Disk Creator to make its program diskettes.

### Preparing to Create Master Diskettes

Disk image files on your hard disk contain all the information to create program diskettes for the factory pre-installed programs on your computer. Microsoft Create System Disks and Master Disk Creator copy these disk images to the diskettes.



*You cannot reinstall programs from the disk image files on the hard disk. You must use program diskettes created with Create System Disks to reinstall Windows 95, and either the diskettes created with Master Disk Creator or the CD-ROM you purchased from Toshiba to reinstall other pre-installed programs.*

---

To run both these programs, you need:

- ❖ About four hours.
- ❖ Up to 72 blank, formatted 3 1/2 inch high-density (1.44MB) diskettes. The diskettes for Microsoft Windows 95 must be formatted but the others need not be. All the diskettes must be write-enabled (the **write-protect tab** at the left corner of the diskette must cover the square hole).

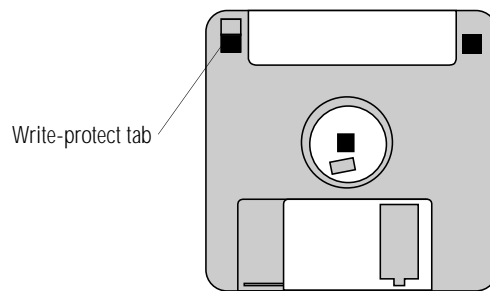

*A write-enabled diskette*

Although you can run these programs at any time, it's a good idea to create your program diskettes the first time you start the computer. That way you don't risk accidentally deleting a program file and having no master diskettes available from which to reinstall it.

## Running Microsoft Create System Disks

If you chose not to create Windows 95 diskettes when you turned the computer on the first time, you should do so now. Since Microsoft Create System Disks requires you to make all the Microsoft Windows 95 diskettes at one time, you need to have at least 32 new, formatted high-density diskettes available before you start the program. Label the diskettes using the pre-printed

---

Microsoft Windows 95 diskette labels provided with your computer.



NOTE

*You can run Create System Disks only once. After you create the diskettes, the program deletes the images from your hard disk.*

---

To run Create System Disks, follow these steps:

**1 Make sure the diskette drive is connected to the computer.**

If you're unsure how to do this, see "Connecting the External Diskette Drive" on page 24.

You may also swap the CD-ROM and diskette drive, following the instructions in "Swapping SelectBay Modules" on page 114.

**2 Click Start, then point to Programs.**

**3 Point to Accessories, then point to System Tools.**

**4 Click Create System Disks.**

Windows 95 opens the Create System Disks program.

**5 Follow the instructions on the screen to create the program diskettes.**

## Running Master Disk Creator

Master Disk Creator creates program diskettes for the rest of the programs pre-installed on your computer (if you decide not to buy the CD-ROM). It is a very simple program to use. You'll need up to 40 high-density diskettes to hold a complete set of program files (more if you are using Windows for Workgroups). Label the diskettes as indicated by Master Disk Creator.

To run Master Disk Creator, follow these steps:

**1 Make sure the diskette drive is connected to the computer.**

If you're unsure how to do this, see "Connecting the External Diskette Drive" on page 24.

You may also remove the current module from the SelectBay and insert the diskette drive module, following the instructions in "Swapping SelectBay Modules" on page 114.

**2 Click Start, then point to Programs.**

**3 Point to Toshiba Utilities, then click Master Disk Creator.**

Master Disk Creator displays a welcome screen.

**4 Click OK.**

Master Disk Creator displays a list of the available disk images.

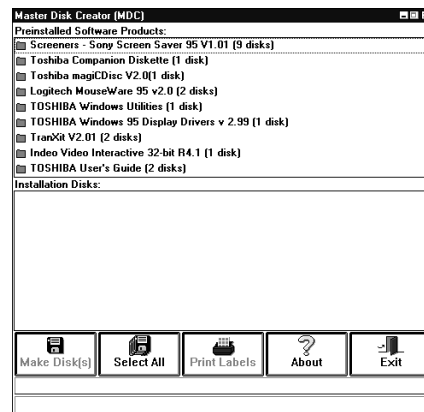

*A sample list of disk images*

**5 To create a complete set of program diskettes, click Select All.**

If you don't want to create a complete set of diskettes now, choose only those programs for which you want to create diskettes.

- 
- 6 Label the diskettes with the names shown on the screen, or click Print Labels to print the labels automatically.**

If you choose to print the labels automatically, make sure the computer is connected to a printer and you have enough printer diskette labels.

- 7 Click Make Disks.**

Master Disk Creator displays the MDC Disk Creation Confirmation screen.

- 8 Insert the appropriately labeled blank formatted diskette into the diskette drive.**

- 9 In the MDC Disk Creation Confirmation screen, choose a Write method and click Create Disk.**

Master Disk Creator begins copying files to the diskette and displays a meter monitoring the copying process.

- 10 When Master Disk Creator prompts you to, press the disk eject button to remove the diskette.**



NOTE

*Check the system indicator panel on the front of the computer. Do not remove a diskette while the disk light is on. Doing so could destroy the information on the diskette and damage the diskette and/or the drive.*

---

- 11 Write-protect the diskette by moving the tab on the back of the diskette to expose the write-protect hole.**

Write-protecting a diskette prevents you from erasing or overwriting the information on the diskette, but doesn't protect the diskette from damage caused by outside sources.



**12 Continue inserting and removing diskettes according to the instructions on the screen.**

Since creating program diskettes will take some time, now is a good time to:

- ❖ Fill in your registration card (if you haven't yet done so).
- ❖ Skim through the rest of this guide.
- ❖ Fill in and mail the reader response card. Toshiba welcomes your comments and suggestions for improving the documentation.

**13 When you've finished making the master diskettes, store them together in a safe place.**

Make sure you keep the diskettes away from extreme temperatures and humidity and strong magnetic fields, such as those generated by large stereo speakers.

## Using the Electronic Guide

Your Tecra 740CDT computer comes with this guide in electronic form on your hard disk. Since the electronic book is stored on your computer, you don't have to take the printed documentation with you when you travel.

The electronic *User's Guide* is a copy of this printed book. This section explains how to use the electronic version of the guide.

### Opening the Book

To open the book, follow these steps:

- 1 Click Start, then point to Programs.**
- 2 Point to Toshiba Utilities, then click User's Guide.**

Windows 95 opens the guide.

## The Parts of the Window

The electronic book opens at the title page.

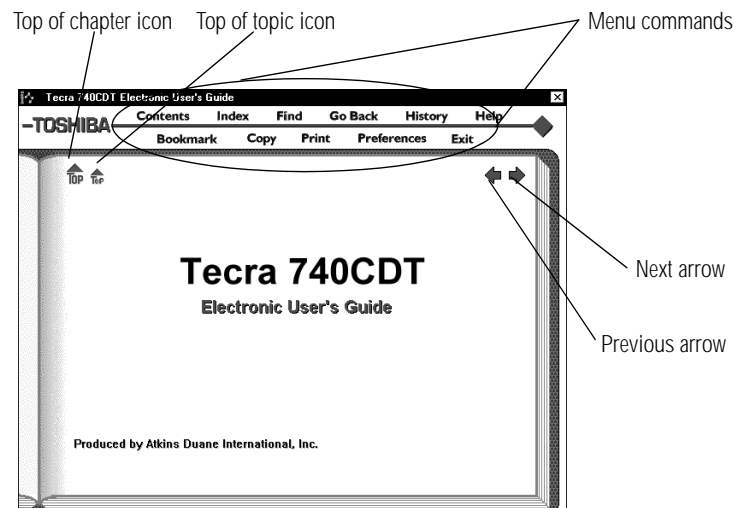

*The title page*

The **menu commands**, icons and arrows provide these options:

- ❖ **Contents** displays the table of contents for the entire book.
- ❖ **Index** displays the index you normally find at the back of the book.
- ❖ **Find** lets you type in a term and search for it in the book.
- ❖ **Go Back** retraces your steps through the book.
- ❖ **History** shows a list of all the places you've been.
- ❖ **Help** explains how to use the book's features.
- ❖ **Bookmark** marks a topic so you can return to it in the future.
- ❖ **Copy** copies selected text to the clipboard.
- ❖ **Print** prints the current topic.
- ❖ **Preferences** lets you customize the book's features.
- ❖ **Exit** closes the book.

- ❖ Clicking the **Top of chapter icon** returns you to the beginning of the current chapter.
- ❖ Clicking the **Top of topic icon** returns you to the beginning of the current topic.
- ❖ The **previous** and **next** arrows allow you to move forward or backward from topic to topic.

### Finding a Topic Quickly

As in a printed book, to find a particular topic you can either search the index or use the table of contents.

In addition to providing an index and table of contents, the electronic *User's Guide* maintains a list of all the words in the book. If the index and table of contents do not contain the word you're looking for, try the Find option. You can search the current topic or the entire *User's Guide*.

Follow these steps:

**1 Click Find.**

The book displays a box for you to enter the word or phrase.

**2 Type the word or phrase and press `Enter` or click Search.**

Find displays a list of all the sections that contain this term.

**3 Select the section you wish to read and press `Enter`.**

Find displays the section.

### Reading a Topic

If the topic contains more text than will fit on the screen, use the scroll bar to read the additional text.

When you get to the end of the topic, click the next arrow to go to the next topic or the previous arrow to go to the previous topic.

Clicking the next arrow takes you through the topics in the same sequence as the printed book.

## Using Cross-References

The topic you located using the Index, Contents or Find may still not be the one you are looking for but, as you read the text, a cross-reference may point you to the section you need.

Cross-references are shown in green underlined text. To view a cross-reference, follow these steps:

### 1 Position the pointer over the cross-reference.

The pointer changes to a pointing hand symbol.

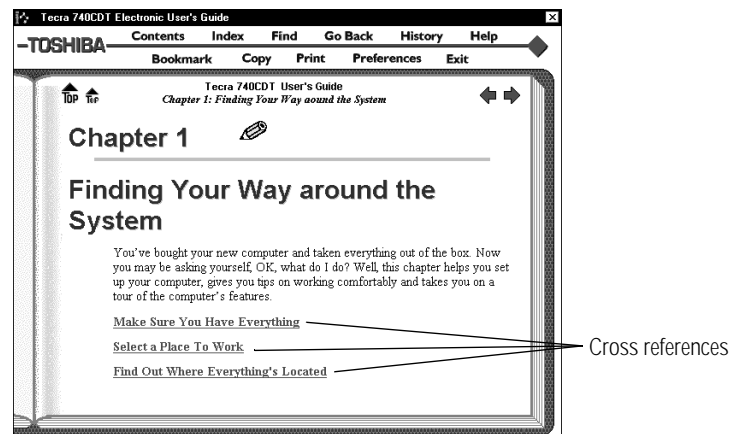

*Using a cross reference*

### 2 Click the cross-reference.

The program displays the section that contains the information relating to the cross-reference you selected.

When you have finished reading the cross-referenced material, click Go Back to return to the original topic.

## Using Bookmarks

Creating a bookmark allows you to mark a portion of the text that you want to be able to find quickly in the future.

### Creating a New Bookmark

To create (or define) a bookmark, follow these steps:

- 1 Position the pointer at the beginning of the text you want to find again.**
- 2 Click Bookmark.**

The program displays the bookmark dialog box.

Add a bookmark (enter name):				X
Entry Up	Entry Down	Remove Entry	Clear List	

*The bookmark dialog box*

- 3 Type a name for the bookmark.**

This can be any name you choose.

- 4 Press Enter or click the X in the upper right corner of the box.**

The program places a small mark at the bottom of the window.

### Viewing the Topic Marked by a Bookmark

To view a marked topic, click its bookmark. Moving the pointer over the bookmark displays the name you assigned.

Another way to locate the topic you marked is through the bookmark list. Follow these steps:

- 1 Click Bookmark.**
- 2 Select the bookmark name you wish to find.**
- 3 Click the box above the list to go to the topic.**

## Deleting a Bookmark

To delete a previously defined bookmark, follow these steps:

- 1 **Enter the name of the bookmark or locate it in the drop-down list box.**
- 2 **Click Remove Entry.**

The program deletes the bookmark.

## Keeping Track of Where You've Been

Unlike a printed book, an electronic book can keep track of what you've already read. If you wish you could go back to the page you read five minutes ago, but you don't remember where you were, follow these steps:

- 1 **Click History.**

The program displays a list of all the topics you've viewed in this session.

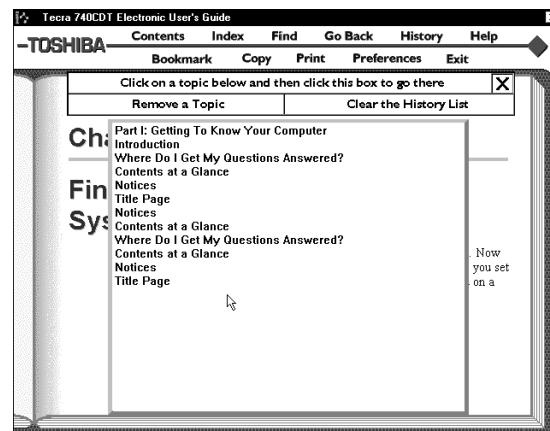

*A history list*

- 2 **Click the topic's title.**
- 3 **Click the top box and you're back where you were before.**

You can delete topics from this list or clear the list entirely by clicking the appropriate boxes.

*Part I: Getting To Know Your Computer*

## Getting Help

The electronic guide comes with its own help text. If you are not sure about a feature, click Help.

Help is context sensitive. If you keep the Help window open, the Help text changes to describe the feature you are currently pointing at with your pointer.

## Using Material from the Book

Though this book is copyrighted, you may select text and copy it to the clipboard for use in your own projects. You may also print individual topics or selected text.

## Copying a Selection

To copy a selection, follow these steps:

### 1 Click Copy.

The book displays the Copy dialog box.

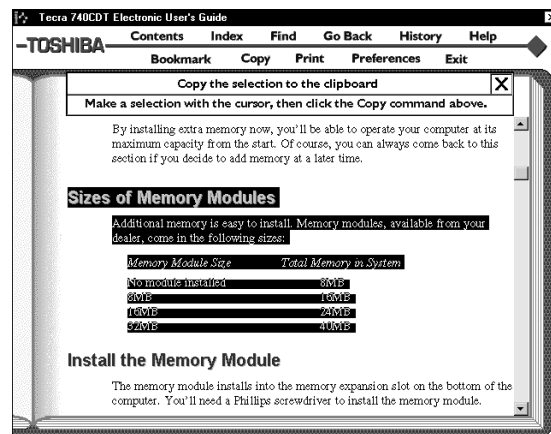

*Selected text ready to copy*

### 2 Select the text to copy.

### 3 Click "Copy the selection to the clipboard."

You can insert this text into another document.

## Printing a Selection or Topic

Follow these steps to print:

**1 Click Print.**

**2 Select the text you wish to print.**

Do not select any text if you wish to print the entire topic.





**3 Click “Print a Selection” to print the text you selected.**

Click “Print the Current Topic” to print the whole topic.

The program prints to the current printer. Before you click Print, make sure the printer is on line (ready) and the printer has paper.

## Changing How the Book Works

The Preferences command lets you customize the electronic book’s features to meet your preferences.

Click below to change preferences:		X
Audible Alerts		
Bookmark Icons		
Checkpoints		
Top Icons		
Text Size	2	
Match Color for Find		

*The preferences dialog box*

**Audible Alerts** sound for various functions. To turn these off, click the Audible Alerts option.

If you would rather not see the **Bookmark Icons**, click here to turn them off. If the bookmark icons are off, click Bookmark to view a list of the bookmarks.

**Checkpoints** are dialog boxes that appear when you are about to do something that may be destructive.

You can control the size of the text in the book window by clicking the **Text Size** option.

The **Match Color for Find** option changes the color the book uses to highlight the text for which you are searching.



## Reinstalling the Electronic User's Guide

If for any reason you need to restore this book to the hard drive, you must use the master program diskette that contains the book files. For more information about master program diskettes, see "Create Master Diskettes or Purchase the CD-ROM" on page 37.

Follow these steps to reinstall on-line documentation:

- 1 Insert the master program diskette in the diskette drive.**
- 2 Click Start, then click Run.**

Windows 95 displays the Run dialog box.

- 3 In the Run dialog box, type the command line `a:\install` and click OK.**

Always install the book into the C:\DOCS folder.

- 4 When the installation is complete, eject the diskette from the drive.**



# Getting to Know Windows 95

---

Windows 95 is the computer's operating system providing a means of communication between your computer, your programs and you. This chapter introduces Windows 95 by taking you through a few basic tasks.

If you've never used Windows before, the skill and confidence you'll gain will more than offset the small amount of time you will spend going through these lessons.

If you've used an earlier version of Windows, you'll notice that Windows 95 is very different. Windows 95 Help discusses a number of the major differences in an easy question-and-answer format. Click Start, then Help to open Help, click the index tab, then type tips and double-click "for Windows 3.1 users."

One of the wonderful things about Windows 95 is its flexibility. While the steps in this chapter will accomplish the indicated tasks, there are often other ways of doing things. For example, if you've used earlier versions of Windows, many familiar key combinations will still work. If you're curious, refer to on-line help or your Windows 95 documentation for more information.

## Lesson 1: Exploring the Desktop

The desktop is the launching pad for everything you can do in Windows 95. You use its features to start programs, find documents, set up system components and most other computing tasks.

The following illustration identifies the major features of the desktop:

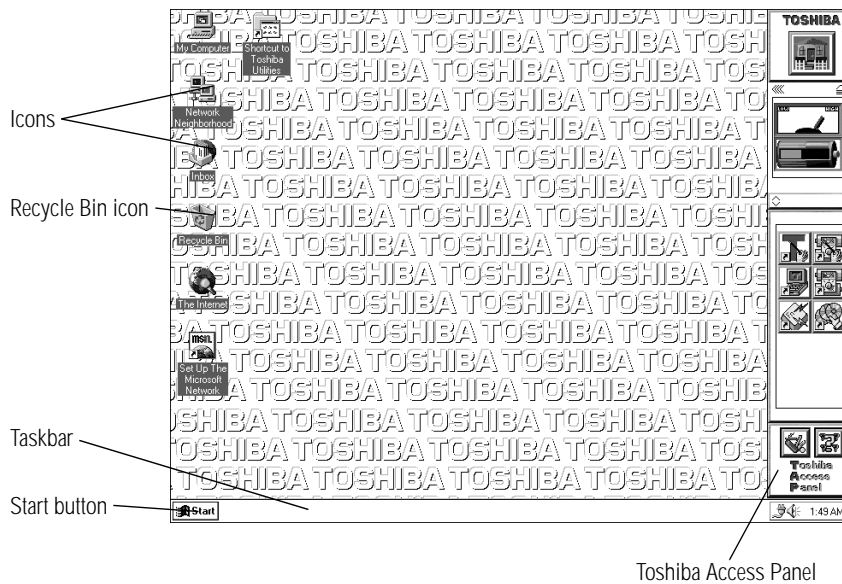

### *The desktop*

The **Start button** does just what it says. You can use it to start programs and open documents, files and folders within Windows 95 (see “Lesson 5: Starting Programs” on page 61).

The **taskbar** lets you know what documents you currently have open. It may also display the time. Right now, the taskbar is blank because you haven’t started anything. As you work through the lessons in this chapter, the taskbar will change to reflect what you’re doing.

The **icons** provide shortcuts to programs, documents, files, folders, system features and components. To learn how to create and use these icons, refer to your Windows 95 documentation.

One special icon is the **Recycle Bin**. You use the Recycle Bin to delete files and remove objects from the desktop. You'll learn more about the Recycle Bin in "Lesson 11: Removing Objects from the Desktop" on page 70.

The **Toshiba Access Panel** displays gauges which monitor the current battery capacity and lets you launch applications, set up configurations, and configure the system's power management settings. When you turn the computer on the first time, the panel is closed. To view the panel, use the secondary button to click the Toshiba Access Panel icon (the small grey "T" on the right side of the taskbar). Click "Start Toshiba Access Panel" on the shortcut menu that appears.

## Lesson 2: Using the AccuPoint Pointing Device

The AccuPoint is your basic tool for moving around and working in Windows 95. This lesson teaches you some of the things you can do with the AccuPoint.

Follow these steps:

**1 Push gently against the left side of the AccuPoint.**

Notice how the arrow (pointer) moves to the right edge of the screen.

**2 Push a bit harder against the right side of the AccuPoint.**

Notice that the pointer moves faster as you increase the pressure on the AccuPoint.

**3 Practice moving around the screen.**

Experiment by moving in different directions and at different speeds. See how quickly you can point to a particular spot on the screen.



**4 Move the pointer to the Start button and click the primary button (it's the larger one).**

Windows 95 opens the Start menu.



*The desktop with the Start menu open*

- 5 Click an empty area of the desktop to close the Start menu.**
- 6 With the pointer in an empty area of the desktop, click the secondary button (the smaller one).**



NOTE

*Throughout the remainder of this guide, the term “click” will refer to the primary button. Instructions requiring the secondary button will specifically mention that button. For example, “click the secondary button.”*

Windows 95 opens the desktop shortcut menu.



*The desktop shortcut menu*

As the name implies, shortcut menus provide quick access to many features of Windows 95. For more information about shortcuts in Windows 95, refer to Help or your Windows 95 documentation.

- 7 Click an empty area to close the shortcut menu.
- 8 Move the pointer to the My Computer icon and click the primary button twice rapidly.

This process is known as “double-clicking.”

The My Computer window opens.

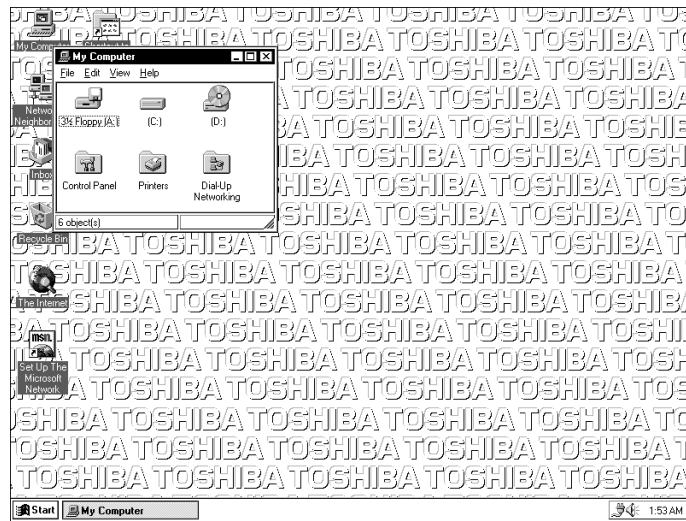

*The desktop with the My Computer window open*

- 9 Click the taskbar at the bottom of the screen and, while holding the primary button, drag the pointer to the right edge of the desktop, then release the primary button.

This process is known as “clicking and dragging.”

The taskbar moves from the bottom to the right edge of the desktop.

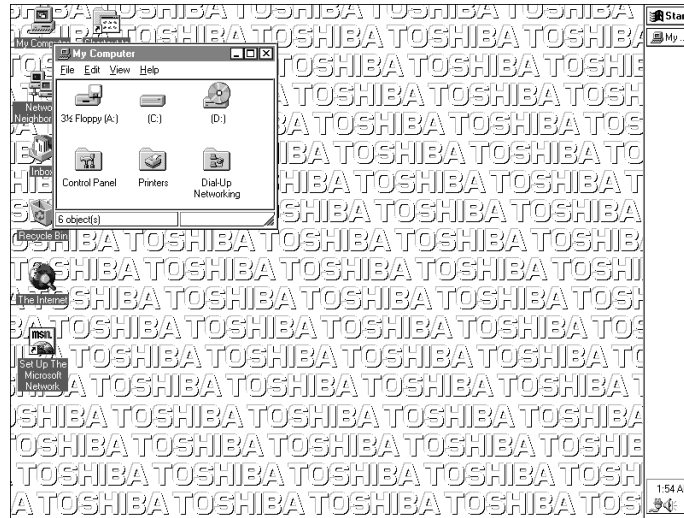

*The desktop with the taskbar on the right*

You may move the taskbar to any of the desktop's four edges.

- 10 Click the taskbar once again and drag it back to the bottom of the desktop.**

## Lesson 3: Creating a New Document

Now that you're used to the desktop, you'll want to go on to do some real work.

With earlier versions of Windows, you had to start a program before you could create a document. Windows 95 lets you choose a type of file and then opens a program appropriate to that file type.

This lesson teaches you how to create a text file without first opening a program. Follow these steps:

- 1 Move the pointer to an empty area of the desktop and click the secondary button.**

Windows 95 displays a shortcut menu of commands applicable to the desktop.



**2 Click New, then click Text Document.**

Windows 95 creates an icon on the desktop called New Text Document with the icon name highlighted.

**3 You'll probably want to give your file a meaningful name, so type My New File and press Enter.**

**4 Double-click the icon.**

Windows 95 opens the new file in Notepad, the text editor built into Windows 95.

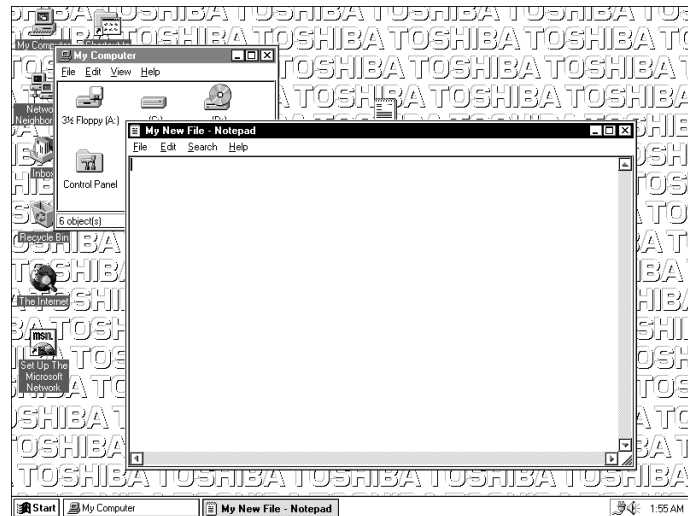

*The Notepad window*

Notice as you open the file that there's a new button on the taskbar that reads My New File - Notepad (the name may be too long to fit into the taskbar space, but if you point to the name, Windows 95 displays all of it). By displaying buttons like this one, the taskbar helps you keep track of the programs and files you currently have open.

To learn more about Notepad, click Help or refer to Windows 95 Help. But for now, leave Notepad open and go on to the next lesson.

## Lesson 4: Creating a New Folder

Windows 95 stores documents, tools and programs in folders. It even stores other folders in folders. In this lesson, you will learn how easy it is to create folders.

To create a folder in which to store the document you just created, follow these steps:

- 1 Move the pointer to an empty area of the desktop and click the secondary button.**

Windows 95 displays the desktop shortcut menu.

- 2 Click New, then click Folder.**

Windows 95 creates an icon on the desktop called New Folder with the icon name highlighted.

- 3 Type a name for the folder and press Enter.**



- 4 Close the Notepad document you just created by clicking the close button on the right side of the Notepad title bar.**

Windows 95 displays the document as an icon on the desktop.

- 5 Click the document icon and drag it to your new folder.**

The outline of the document icon moves across the desktop.

- 6 Position the document icon over the folder icon (the folder icon should be highlighted), then release the primary button.**

The document disappears into the folder.

- 7 To see your document, double-click the folder icon.**

A window opens and displays the contents of the folder.



- 8 Close the window by clicking its close button.**

Continue with the next lesson to learn how to start programs.

## Lesson 5: Starting Programs

After you've gained some experience and added some programs of your own, you'll know exactly which program to use for a particular task. This lesson teaches you how to start programs from the desktop, using two of the programs built into Windows 95.

Follow these steps:

**1 Click Start, then point to Programs.**

Windows 95 displays a list of program folders.

**2 Point to Accessories, then click Paint.**

Windows 95 opens Paint, a simple drawing program.

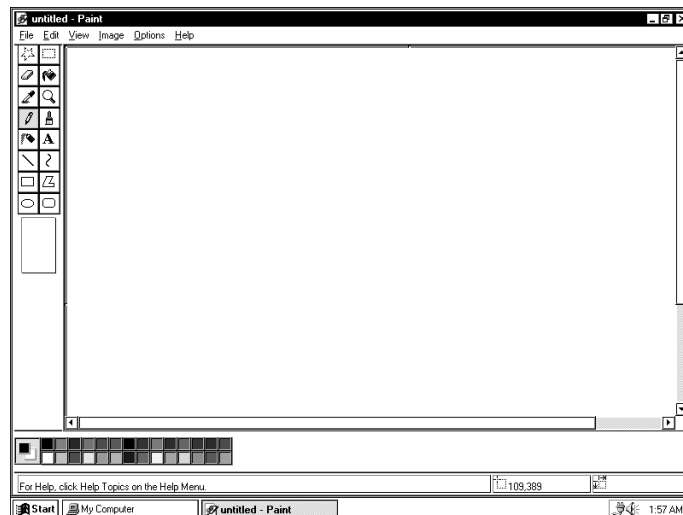

*The desktop with Paint open*

Your desktop now looks something like the above illustration. Notice again the new addition to the taskbar.

**3 To open a second program, click Start, then click Programs.**

**4 Click Windows Explorer.**

Windows 95 opens Windows Explorer and adds a new button to the taskbar.

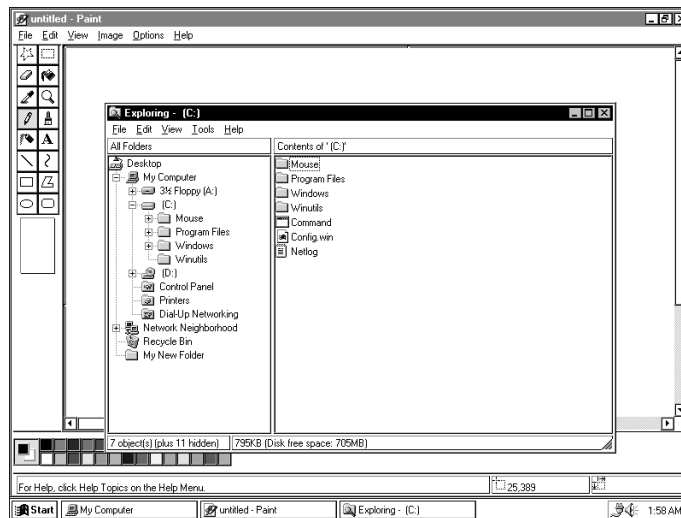

### *The Windows Explorer*

The Windows Explorer provides access to all your computer's resources. For example, it lets you see all the files in a particular folder on the computer's hard drive.

Notice the taskbar now has two buttons on it, one for Paint and one for Windows Explorer.

### **5 Click the Paint button on the taskbar.**

Windows 95 displays the Paint program. You can move back and forth between the two programs by alternately clicking each button.

Windows 95 places the active window on top of other windows on the desktop unless you have resized the windows.

## Lesson 6: Resizing and Reshaping Windows

If you've been following the steps in this chapter, you now have a screen cluttered with several program windows. Fortunately, it's simple to recreate order out of this chaos. You can resize windows so you can see more than one of them at a time. You can also hide windows by removing them from the desktop without actually closing your document or program.

This lesson introduces several ways to adjust the size and shape of windows open on the desktop.

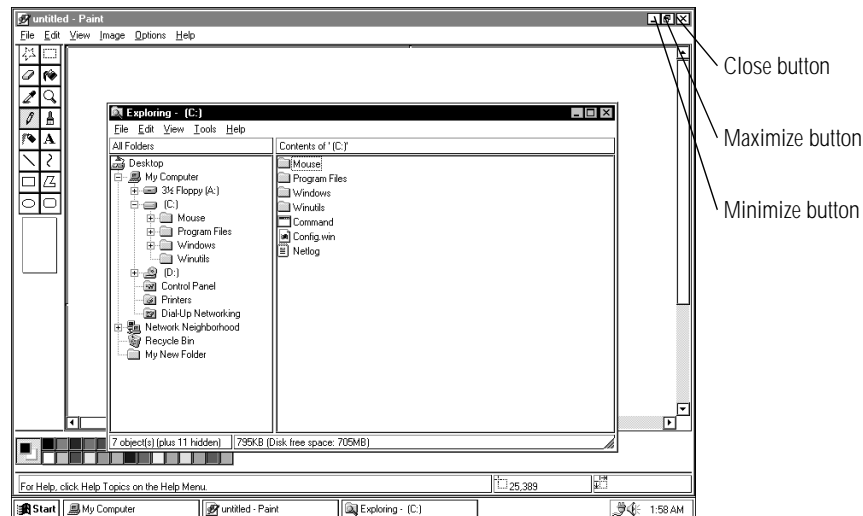

*Windows Explorer open on the desktop*

First, notice the above illustration. It identifies three buttons that are on the title bars of most windows. These are the minimize, maximize and close buttons. Now that you know where these buttons are, follow these steps:

- 1 To make the Windows Explorer window the active window, click the Windows Explorer button on the taskbar.**

Windows displays Windows Explorer on top of other windows on the desktop and highlights the menu bar to show it is the active window.

 **2 Click the minimize button at the top right of the Explorer window.**

Explorer disappears from the desktop. However, it's still open, as you can see from the taskbar.

Minimizing program windows is a good way to clean up the desktop without actually closing programs.

 **3 Click the maximize button at the top right of the Paint window.**

The Paint window expands to the full size of the screen, except for the taskbar. Notice that the maximize button has changed. It's now called the restore button.

Maximizing a program is a good way to work when you're only using that program and don't want any distractions on the screen.

 **4 Click the restore button.**

Paint returns its previous size and location. Notice that the restore button has changed back into the maximize button.

For the next few steps assume that you want to be able to see both the Paint and Windows Explorer at the same time.

**5 Move the pointer to the right side of the Paint window.**

The pointer changes to a two-headed arrow.

**6 Click and drag the edge of the window until it takes up just less than half the width of the desktop.****7 Click the title bar of the Paint window and, while holding the primary button, drag the window to the left side of the desktop.**

You can move any window by clicking its title bar and dragging it.

**8 Click the Windows Explorer button on the taskbar.**

Windows 95 displays the Windows Explorer window.

**9 Repeat steps 6 and 7 to size and position the Windows Explorer, placing it at the right side of the desktop.**

Now that you've got the windows side-by-side, you can see how you could refer to one window while working in the other.

When you are working with documents and programs, resizing and moving windows allows you to rearrange the desktop to suit your tastes and needs. Experiment with different sizes and placements of windows. Discover the most comfortable and efficient arrangement for your work.

At this point you have three programs open on the desktop. Go on to the next lesson to learn how to close them.

## Lesson 7: Closing Your Programs and Files

Once you're finished working with a document or program, it's a good idea to close it to free up the space in memory for something else. While you can run a number of programs at the same time in Windows 95, having a large number of programs and documents open simultaneously can slow down your system.

This lesson teaches you how to close the program you've opened earlier in this chapter. Follow these steps:



**1 Click the close button at the top right of the Explorer window.**

That's all there is to it. Windows Explorer closes, removing the Explorer button from the taskbar as well.

**2 Close Paint, Notepad and the My Computer window (assuming it's still open) by clicking their close buttons.**

## Lesson 8: Creating Shortcuts

By adding shortcuts to your desktop, you can open programs or files with the click of a button. You'll probably want to create shortcuts for the programs you use most frequently. This lesson explains how to create shortcuts to two Windows 95 accessories, Calculator and Character Map.

To create a shortcut, follow these steps:

- 1 Move the pointer to an empty area of the desktop and click the secondary button.**

Windows 95 displays the desktop shortcut menu.

- 2 Click New, then click Shortcut.**

Windows 95 displays the Create Shortcut dialog box.

- 3 In the Command line box, type `c:\windows\calc.exe` and click Next.**

- 4 Windows 95 prompts you to select a name for the shortcut.**

- 5 Type Calculator and click Finish.**

Windows 95 displays the new shortcut on your desktop.

Now assume you want to create a shortcut, but don't know the location of the program.

- 6 Click Start, then point to Find.**

- 7 Click Files or Folders.**

Windows 95 displays the Find dialog box.

- 8 On the Name and Location tab, type `char` in the Named box.**

- 9 Click Find Now.**

Windows 95 displays a list of all the files with "char" in their names.



**10 Click the Character Map file with the secondary button and drag it to the desktop.**

A shortcut menu displays.

**11 Click Create Shortcut(s) Here.**

A shortcut to the Character Map appears on your desktop.

Clicking a shortcut icon opens the program or folder immediately. Place as many shortcuts on your desktop as you find useful.

Continue to the next lesson, where you'll discover the meaning of object properties in Windows 95 by changing the wallpaper on your desktop.

## Lesson 9: Changing the Wallpaper

Windows 95 treats all windows, icons, programs, drives, etc. as self-contained objects. You can set each object's properties (such as size, position on-screen, and color) individually.

This lesson introduces object properties by showing you how to change one of the properties of the desktop, the wallpaper.

To change the wallpaper, follow these steps:

**1 Move the pointer to an empty area of the desktop and click the secondary button.**

Windows 95 displays the desktop shortcut menu.

**2 Click Properties.**

Windows 95 displays the Display Properties dialog box.

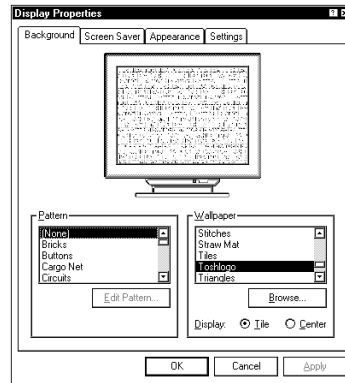

*The Display Properties dialog box*

Click the Background tab to bring it to the front.

- 3 Scroll through the wallpaper options by clicking the scroll arrows in the Wallpaper list box.**
- 4 Try a different wallpaper pattern by clicking a name in the list box.**

Windows 95 displays a sample of the wallpaper selection in the monitor above the list box. Try several patterns.

- 5 To apply a pattern to your desktop, click Apply.**
- 6 After you've chosen a wallpaper pattern and applied it to your desktop, click OK.**

Windows 95 returns you to the desktop, with your new wallpaper displayed.

You can view any object's properties by clicking it with the secondary button, and choosing Properties from the shortcut menu that appears.

The next lesson explains how to set two other properties: the date and time.

## Lesson 10: Setting the Date and Time

You set the computer's date and time properties when you turned the computer on the first time and set up Windows 95. To change the date and time settings now, follow these steps:

**1 Click Start, then point to Settings.**

**2 Click Control Panel.**

Windows 95 displays the Control Panel.

**3 Double-click the Date/Time icon.**

Windows 95 displays the Date/Time Properties dialog box.

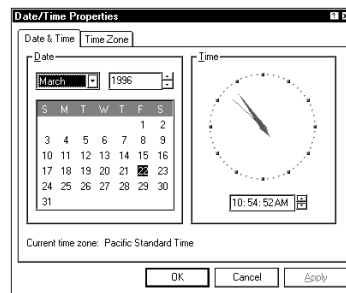

*The Date/Time Properties dialog box*

This dialog box has two tabs. Click on a tab to bring it to the front.



**HINT**

*To open this dialog box more quickly, click the time display on the taskbar with the secondary button, then click Adjust Date/Time.*

**4 On the Date & Time tab, select the correct month, year, day, and time.**

**5 On the Time Zone tab, select your time zone from the drop-down list box.**

**6 When you're done, click OK.**

You're almost done. Now go on to the next section to finish cleaning up the desktop.

## Lesson 11: Removing Objects from the Desktop

Earlier in this tutorial, you created a new icon on the desktop. Since everything you've done to this point has been just practice, you'll want to return the desktop back to its original uncluttered state. This lesson explains how to remove objects from the desktop and introduces the Recycle Bin.

To remove your new icons from the desktop, follow these steps:

**1 Click the icon for the folder you created in "Lesson 4: Creating a New Folder" and, while holding the primary button, drag it until it's over the Recycle Bin (the Recycle Bin icon should be highlighted).**

**2 Release the primary button.**

The icon disappears. But, with Windows 95, it isn't really gone. It's merely set aside to where you can delete it completely later.

**3 Repeat steps 1 and 2 for any other icons you created during this tutorial.**

Each icon disappears as you drop it on the Recycle Bin.

**4 Double-click the Recycle Bin icon.**

Windows 95 opens the Recycle Bin window.



*The Recycle Bin window*

Notice that all the icons you dropped on the Recycle Bin are listed.

**5 To completely remove an object, click it and click File, then click Delete.**

The object is gone forever.

Later on—in your real work, not in this tutorial—you’ll use the Recycle Bin to delete other objects such as folders, documents, and sometimes even programs. Still, the process is the same. Drag an object’s icon to the Recycle Bin and, sometime when you’re absolutely certain that you never want to see it again, delete it from there.

If you change your mind and want to restore an object you sent to the Recycle Bin, click the object with the secondary button and click Restore. Windows 95 restores the object to the place from which it was deleted.



**HINT**

*To delete everything from the Recycle Bin at once, choose Empty Recycle Bin from the File menu.*

## Lesson 12: Exploring the Toshiba Access Panel

The Toshiba Access Panel, at the right side of the desktop, is a handy place to check the power usage gauges, launch Toshiba utilities and other programs, access a variety of on-line help features, and set up separate configurations for working at home, at the office, or while traveling.

When you turn the computer on the first time, the panel is disabled. To view the panel, use the secondary button to click the Toshiba Access Panel icon (the small grey “T” on the right side of the taskbar). Click “Start Toshiba Access Panel” on the shortcut menu that appears.

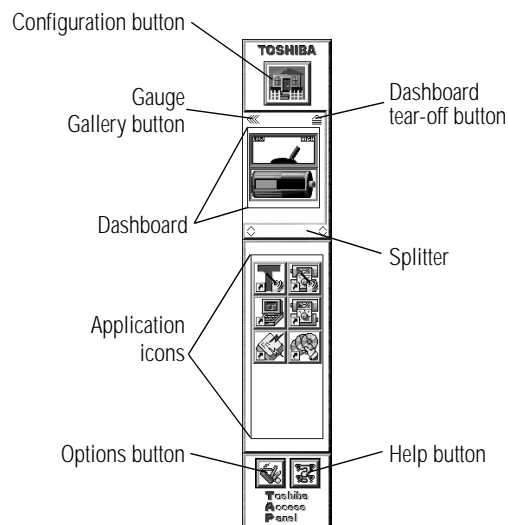

*The Toshiba Access Panel*

The preceding illustration identifies the sections of the Toshiba Access Panel. Follow these steps to explore some of the panel's features:

- 1 To move the panel from the right side of the desktop to the left side, click the panel and, while holding the primary button, drag the panel to the new position.**

When the panel is where you want it, release the primary button. You can place it on the right or left sides of the desktop only.

The Toshiba Access Panel allows you to set up separate configurations to use while you're at home, at the office, or traveling. For example, if you use the battery while traveling and the AC adapter and power cord when you're at the office, you could set up a travel configuration that turns on the computer's battery saving features, and an office configuration that turns those features off.

You keep track of which configuration you're using by looking at the icon on the **configuration button**.

- 2 To change which configuration you're using, click the **configuration button**.

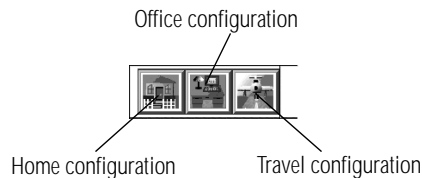

*The configuration slider bar*

The configuration slider bar extends to the left, displaying the **home**, **office**, and **travel** buttons.

- 3 Click the button for the configuration you wish to use.

The new configuration takes effect and the configuration slider bar disappears.

The **dashboard** section of the Toshiba Access Panel displays gauges that show the current battery capacity in a variety of formats. You can choose which gauges display in the dashboard.



- 4 Click the Gauge Gallery button **just above the dashboard**.

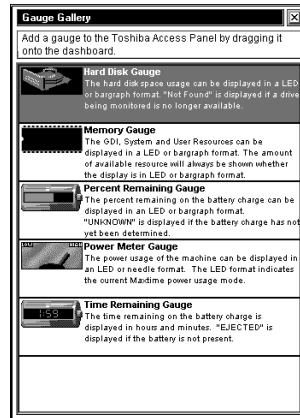

*The Gauge Gallery*

The Gauge Gallery opens. This window lists the available gauges:

- ❖ The Hard Disk Gauge displays the hard disk space usage in LED or bar graph format.
- ❖ The Memory Gauge displays the available GDI, system, or user resources in LED or bar graph format.
- ❖ The Percent Remaining Gauge displays the percentage of battery charge remaining in LED or bar graph format.
- ❖ The Power Meter Gauge displays the current power usage mode in LED or needle format.
- ❖ The Time Remaining Gauge displays the amount of time remaining before the battery discharges completely.

**5 To hide the Gauge Gallery, click its close button.**

The Gauge Gallery disappears.

The **application icons** provide a convenient way to start programs. Clicking an icon starts its associated program.

You can add your own application icons to the panel.



- 6 For example, to add the Windows 95 My Briefcase program to the panel, click the My Briefcase icon and drag it to the application icons section of the Toshiba Access Panel.**

The panel displays a pop-up menu.

- 7 Click Add to All to display the My Briefcase icon on the panel for all your configurations.**

Click Add to Home/Office/Travel to display the My Briefcase icon on the panel for the current configuration only.

## Lesson 13: If I'm Lost—What Do I Do?

Windows 95 and the Toshiba Access Panel both provide excellent on-line help. This lesson provides instructions for using both.

### Windows 95 Help

Windows 95 has an excellent help facility. If you can't figure out how to do something, the answer is probably only a few clicks away.

Assume that you want to draw a picture but don't know how.

Follow these steps:

- 1 Click Start, then click Help.**

Windows 95 opens the Help window.

- 2 If you don't see the Index page, click the Index tab.**

Help displays the Index page.

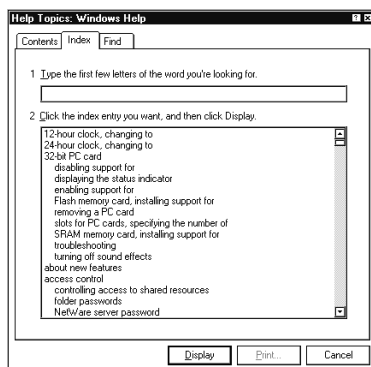

*The Help window on the Index page*

Most of the screen contains a list of topics. The upper part of the screen, where the cursor is flashing, lets you type in a topic.

### 3 Type picture.

Notice as you type that the topic list adjusts to locate what you typed. When you type the letter p, the topic list moves to the first entry that begins with P, etc.

There are a number of topics listed under Picture. One of them, Drawing, looks promising.

### 4 Double-click drawing.

Help opens a topic screen that gives a brief description of how to draw pictures, including an icon to start the Paint program.

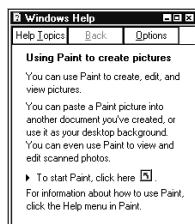

*The Drawing help screen*

**5 Click the Click here icon.**

Windows 95 opens the Paint program.

Not every help topic screen contains an icon to start a program. However, when you do encounter one, it's a great way to move from reading about your question to an instant solution.

**6 Just to clean up the desktop, close both Help and Paint by clicking on their close buttons.**

## Toshiba Access Panel Help

The Toshiba Access Panel provides three types of help. In addition to traditional text help, it provides video help, which not only explains but demonstrates how to use its features. Follow these steps:

**1 Click the help button at the bottom of the panel.**

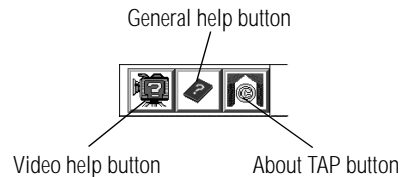

*The help slider bar*

The help slider bar extends to the left, displaying the **video help**, **general help** and **about TAP** buttons.

**2 Click one of the buttons and follow the instructions on the screen.**

You're almost done! The next (and last) lesson tells you how to shut down Windows 95 and turn your computer off.

## Lesson 14: Turning Your Computer Off

It's very important that you let Windows 95 shut down your computer. As it shuts down, Windows 95 performs a number of tasks that ensure that everything's in place the next time you turn the computer on. This lesson teaches you how to shut down Windows 95.

To turn your computer off, follow these steps:

### 1 Click Start, then click Shut Down.

Windows 95 displays the Shut Down Windows dialog box.



*The Shut Down Windows dialog box*

### 2 Select Shut down the computer, then click Yes.

Windows 95 displays a message that it is shutting down and turns the computer off. When the power is off, the on/off light goes out.



# Learning the Basics

---

If you are a novice computer user, this chapter is for you. It describes many day-to-day computer operations and includes lists of computing tips.

## Computing Tips

This section presents a few rules that experienced users take for granted.

### Two Things Every User Learned the Hard Way

- ❖ Save your work frequently.

Your work stays in the computer's temporary memory until you save it to disk. When the network goes down and you must restart your computer to reconnect, or your battery runs out of charge mid-flight, you'll lose all the work done since you last saved.

See the instructions in "How To Save Your Work" on page 56.

- ❖ Back up your files to diskette or tape on a regular basis.

It's easy to put off backing up because it takes time. However, if your hard disk suddenly fails, you'll lose all the data on it unless you have backup copies.

See the instructions in "How to Back Up Your Work" on page 107.

### Five More Things Every Computer User Should Do

- ❖ Take frequent breaks to avoid strain.

See "Keep Yourself Comfortable" on page 3.

- ❖ Turn the computer off using Windows 95's Shut Down or Suspend command, unless Resume Mode is on. See "When You Turn the Computer On" on page 83 for information about Resume Mode and the Suspend command.

Windows 95 records information such as your desktop setup during its shutdown procedure.

- ❖ Set up your computer to suit your tastes and needs.

If you don't like the colors or the fonts on the screen, you can change them. Click a blank area of the desktop with the secondary button, then click Properties to open the Display Properties dialog box. The Appearance tab of this dialog box allows you to choose the colors and font sizes you see on the screen.

- ❖ Scan all new files for viruses.

This precaution is especially important for files you receive from your friends or download from the Internet. See "Viruses and How to Cure Them" on page 277 for details.

- ❖ Run Create System Disks to make program diskettes for Windows 95 and either Run Master Disk Creator or purchase the master program CD-ROM for other pre-installed software.

At some point, you may need to reinstall programs that came pre-installed on your computer's hard disk. See "Create Master Diskettes or Purchase the CD-ROM" on page 37 for more information.

## Five Things You Should Never Do

- ❖ **Don't** spill a drink or other liquid into the computer's keyboard.

If liquid does get into the keyboard, turn the computer off immediately and unplug it. Get as much liquid out of the keyboard as possible. Leave the computer off overnight to give it time to dry out before you return to work.

- ❖ **Don't** format a disk that contains valuable information.

Formatting removes all the information that's currently on the disk. Always double-check a disk before you format it.

- ❖ **Don't** turn the computer off when a drive indicator light is on.

Doing so may damage the disk, the drive or both.

- ❖ **Don't** expose your diskettes or the computer to magnetic fields, such as the field generated by large stereo speakers.

Doing so can erase important files.

- ❖ **Don't** be afraid to use your computer, it's just a machine.

Provided you follow the advice in this guide, you're unlikely to do your computer any harm. So use it and have fun.

## When You Turn the Computer On

Normally, when you turn the computer on it goes through its self-test and startup procedure before loading Windows. As it does this, a number of messages flash across the screen.

To save time and battery power you can skip these steps by using Windows 95's Suspend command or Toshiba's Resume Mode when you turn the computer off.

Both these methods provide a sort of electronic bookmark. They use the computer's backup battery to store its current state in memory while the power is off and restore it to that state when you turn the computer back on. The system maintains the information until the backup battery loses its charge (after approximately eight hours).



By using Toshiba's Resume Mode, you can take advantage of additional power saving features. These features let you:

- ❖ Configure the computer to suspend when you close the display panel, and resume when you open it again. You can set this option in the Toshiba System Control Panel (on the Start Up Options page) or in TSETUP.
- ❖ Set the computer to turn on automatically at a time and date you choose. You can set this option in the Toshiba System Control Panel (on the Power-On Timer page) or in TSETUP.

For information about the Toshiba System Control Panel, see "The Toshiba System Control Panel" on page 417. For information about TSETUP, see "TSETUP" on page 427.

## Using the Suspend Command

To turn the computer off using Windows 95's Suspend command:

- 1 Save any files you are using over a local area network.**



*Your network connection may be lost when you suspend your computer.*

---

- 2 Click Start.**
- 3 Click Suspend.**

The Suspend command saves the current system settings, shuts down Windows 95, and turns the computer off.

## Using Resume Mode

There are several ways to turn Resume Mode on and off. This section describes how to use a key combination, called a hotkey, to select Resume Mode. This is the quickest method. Turn to “Starting Again Where You Left Off” on page 149 for the other methods.

To select Resume Mode, follow these steps:

- 1 Press  $\text{Fn} + \text{F3}$  to display the Resume Mode pop-up window.**

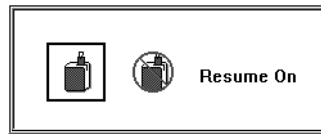

*The Resume Mode pop-up window*

- 2 While continuing to hold  $\text{Fn}$ , press  $\text{F3}$  until the Resume Mode icon is selected.**
- 3 Release the  $\text{Fn}$  key.**

The system is now in Resume Mode.

## Turning the Computer Off in Resume Mode

To turn your computer off when you are using Resume Mode, follow these steps:

- 1 Save your files to the hard disk or a diskette.**
- 2 Check that the disk and CD activity lights are off.**
- 3 Turn off the computer.**
- 4 Turn off the power to any external devices connected to the computer.**

If you realize you can continue working after all, wait a few seconds before turning the computer back on again.

## Starting the Computer in Resume Mode

To start your computer when you are using Resume Mode, follow these steps:

- 1 Turn on any external devices connected to the computer.**
- 2 Press the power button and hold it until the power light comes on.**

The system starts and displays the same screen as when you turned off the power.



*If the system displays the WARNING RESUME FAILURE message when you turn the computer back on in Resume Mode, the computer's backup battery is probably discharged. This may happen if you've had the computer turned off for a long time. To recharge this battery, plug the computer in and turn it off for seven hours.*

---

## How to Adjust the Display Brightness

Where you use the computer affects how easily you can see the images on the display panel. Adjusting the display panel angle often helps, but you may also need to adjust the display brightness. To make the display brighter, follow these steps:

- 1 Click Start, then point to Settings.**
- 2 Click Control Panel.**

Windows 95 opens the Control Panel.

### 3 Double-click the MaxTime icon.



You can also open MaxTime by clicking the MaxTime icon on the Toshiba Access Panel.

The icon on the panel looks like this: 

The MaxTime Control Panel opens.

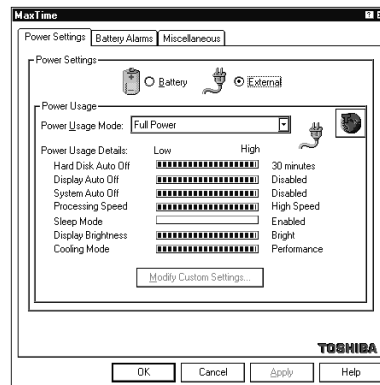

The MaxTime Control Panel

### 4 Set the Display Brightness option to Bright or Super-Bright.

You can do this in two ways:

- ❖ Set the Power Usage Mode to Full Power. This automatically sets the Display Brightness option to Bright (if you're using the battery to power the computer) or Super-Bright (if you're using the AC adapter), and changes the other battery settings to maximize system performance.
- ❖ Set the Power Usage Mode to Custom Settings, then click Modify Custom Settings. In the Modify Custom Settings dialog box, move the Display Brightness slider to Bright or Super-Bright and click OK.

- 5 **Click OK to save your settings and exit the MaxTime Control Panel.**
- 6 **For more information about the MaxTime Control Panel, see “The MaxTime Control Panel” on page 409.**

## How to Start a Program

In Windows 95 there are two ways of starting a program—from an icon or from the Windows Explorer.

To start an MS-DOS program from a system prompt, refer to “Starting Some MS-DOS Programs” on page 90.

### Starting a Program from an Icon

To start a program that has an icon in the Programs menu, follow these steps, which use the Windows 95 Wordpad program as an example:

- 1 **Click Start, then point to Programs.**

Windows 95 displays the Programs menu, which lists programs and program groups. If your program is listed go to step 3, otherwise continue with step 2.

- 2 **Point to the program group, in this case Accessories.**

Windows 95 displays the Accessories menu.

- 3 **Click the program, in this case Wordpad.**

Windows 95 opens Wordpad. Wordpad is a text editor—a scaled-down word processor without the frills.

That’s all there is to it. To close the program, click the close button at the upper right corner of the window.

---

## Starting a Program from the Explorer

If a program isn't in the Programs menu, you can start it in Windows Explorer. To use this method, you need to know the file name and location of the program.

This example, like the one above, opens Wordpad, using its file name of WORDPAD.EXE.

To start a program from the Explorer, follow these steps:

**1 Click Start, then point to Programs.**

**2 Click Windows Explorer.**

Windows 95 opens the Explorer.

**3 In the left part of the screen, under the C: icon, double-click the folder containing the program, in this case Program Files.**

The Explorer shows the contents of the Program Files folder on the right side of the screen. The left side of the screen shows all the folders contained within the Program Files folder.

**4 Click Accessories.**

The Explorer shows the contents of the Accessories folder on the right side of the screen.

**5 Double-click Wordpad.**

Windows 95 opens Wordpad.

## Starting Some MS-DOS Programs

Most MS-DOS programs will run in Windows 95. If an MS-DOS program won't run, follow these steps:

**1 Click Start, then click Shut Down.**

Windows 95 displays the Shut Down Windows dialog box.

**2 Click Restart the computer in MS-DOS mode, then click Yes.**

Windows 95 shuts down the computer, then restarts it in MS-DOS mode and displays a system prompt.

**3 Refer to the program's documentation for the command that starts the program.**

**4 At the system prompt, type the command and press Enter.**

## How to Use the Keyboard

This section describes the keys on the computer keyboard and explains how it differs from a typewriter keyboard.

### The Character Keys

For these keys, typing on a computer keyboard is very much like typing on a typewriter. However, there are some exceptions:

- ❖ When you press the spacebar, a computer does not simply pass over an area of the page like a typewriter does. Instead, it creates a space character just as it creates characters representing letters or symbols.
- ❖ The lowercase l (el) and the number 1 are not interchangeable.
- ❖ The uppercase O and the number 0 are not interchangeable.
- ❖ On a typewriter, the shift lock key locks all the keys into their uppercase positions. On a computer keyboard, pressing the Caps Lock key changes only the alphabet keys to uppercase—the number and symbol keys aren't affected.

---

## The Other Keys

In addition to the character keys, the computer keyboard contains a number of keys that carry out special computer tasks. This section describes these special keys.

- ❖ The 12 function keys (F1, F2, etc.) across the top of the keyboard carry out program-specific tasks. To find out what these keys do, refer to the program's documentation.
- ❖ The function of the Ctrl key (Control key) also varies according to the program you're using.
- ❖ In Windows programs, pressing the Alt key lets you open menus.
- ❖ Pressing the Fn key simultaneously with one of the specially marked keys allows you to emulate a 101-key keyboard (discussed below), turn keyboard overlays on and off (page 305) and control various system functions.

Toshiba's powerful Fn-esse program lets you assign your own Fn key combination to launch a Windows program or document quickly from anywhere in Windows 95. Instructions for using this program are given in "Starting Programs Faster with Fn-esse" on page 292.

## Typing Numbers

The keys with white numbers on the right front form the numeric overlay. This overlay lets you enter numeric data as you would using a ten-key numeric keypad. The following illustration highlights the keys in the numeric overlay.



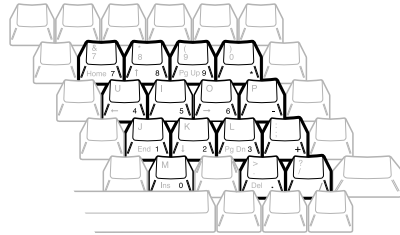

### *The numeric overlay*

To turn the numeric overlay on and off, press Fn + F11. The num-lock light on the indicator panel shows whether the numeric overlay is on or off.

You can still use the overlaid keys to type alphabetic characters while the numeric overlay is on. To do so:

- ❖ For lower case letters, hold Fn down while you press the keys.
- ❖ For upper case letters, hold Fn + Shift down while you press the keys.

The keys of the numeric overlay also act as a cursor control overlay, providing the ↑, ↓, ←, and → keys, as well as Ins, Del, Home, End, PgUp and PgDn. To use the cursor control keys when the numeric overlay is on, press and hold Shift while you use the overlay keys. To return to the numeric overlay, release Shift. For more information about the cursor control overlay, refer to “The Cursor Control Overlay” on page 305.

## How to Save Your Work

Before you turn the computer off and take a well deserved break, save your work to the hard disk or a diskette. This is one of the most important rules of computing.



NOTE

*Save your data even when you're using Resume Mode or the Suspend command, in case the backup battery discharges before you return to work.*

Saving documents is quick and easy, so it's a good idea to get in the habit of saving frequently. That way, if you run into trouble, you won't lose many long hours of work.

Many programs offer a feature that saves documents at regular intervals, such as every fifteen minutes. Check your programs' documentation to see whether they have an automatic save feature.

This section describes the procedure for saving files in Windows programs. If you're using an MS-DOS program, refer to your program documentation for instructions on saving files.

To save a file, follow these steps:

**1 On the File menu of your Windows program, click Save.**

If you're working with a document that already has a file name, that's all there is to it. If you've created a new document, your program displays a Save As dialog box.

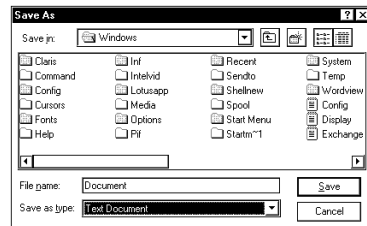

*A sample Save As dialog box*

Use this dialog box to specify where to store the document and to give it a file name.

**2 Choose the drive and folder where you want your file to be stored.**

**3 Type a file name and click OK.**

Windows 95 supports file names of up to 255 characters, and the names can include spaces.

If you plan to share your files with a computer using MS-DOS or an older version of Windows, the file name must be no more than eight characters followed by a period and a three-character extension. You may use all the letters and numbers on the

keyboard plus the following characters: `_`, `^`, `$`, `~`, `!`, `#`, `%`, `&`, `{`, `}`, `(`, `)`, `@` and `'`. An MS-DOS file name must not contain a space.

Most programs assign an extension that identifies the file as being created in that program with a particular format. For example, Microsoft Word saves files with a `.DOC` extension. Creating your own extension is usually unwise since the program is unlikely to recognize a strange extension and may refuse to handle your file correctly.

## How to Print Something You've Created

Before you can print your work, you need to:

- ❖ Connect the printer to the computer (discussed in “Connecting a Parallel Printer” on page 26).
- ❖ Set up Windows 95 to work with the printer (discussed below).

You only need to perform the setup step the first time you connect the printer. If you'll be using more than one printer or changing printers, you'll need to set up Windows 95 to run with the additional printer(s).

### Setting Up Windows 95 to Work with Your Printer

When you turned your computer on for the first time, the Windows 95 Setup program offered you the opportunity to define a printer. Read this section if you didn't do so, or want to set up a different printer.

Setting up a printer involves choosing a printer driver. This special program acts as a translator that turns your work into a form the printer can understand. This section describes how to select a printer driver in Windows 95.

If you're using any non-Windows programs, you'll need to set up a printer driver for each of those programs. Refer to your program's documentation for more information.

In Windows 95, you set up a printer with the Add Printer Wizard. Follow these steps:

**1 Click the Start button, then point to Settings.**

**2 Click Printers.**

Windows 95 displays the Printers window.

**3 Double-click Add Printer.**

Windows 95 opens the Add Printer Wizard.

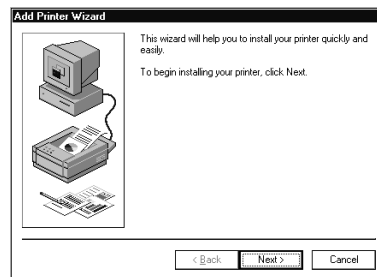

*The Add Printer Wizard*

**4 Click Next.**

The Add Printer Wizard asks you to select your printer.



NOTE

*If your printer is Plug and Play, Windows 95 recognizes it automatically. You can ignore the remainder of this section.*

**5 If the printer you're setting up:**

- ❖ Isn't connected to a network, select Local printer and click Next.
- ❖ Is connected to a network, select Network printer and click Next.

The Add Printer Wizard asks you to select your printer.

**6 From the list of manufacturers and printers, select your printer and click Next.**

The Add Printer Wizard asks for the printer port.

**7 Select the port settings according to the instructions in your printer's documentation and the port to which your printer is connected, then click Next.**

The Add Printer Wizard asks you to enter a "friendly" printer name.

**8 Enter a name for your printer.**

If you're using more than one printer, make sure the name is descriptive enough to help you tell the difference.

**9 If you want this printer to be:**

- ❖ The default printer for Windows 95, click Yes, then click Next.
- ❖ Available when specifically requested, click No, then click Next.

Windows 95 prompts you to print a test page.

**10 If your printer is connected and turned on, click Finish to print a test page.**

To finish the setup procedure without printing a test page, click No, then Finish.

You're ready to print.

## Printing Your Work

Once you have set up your printer and software correctly, printing a file from a Windows program is easy. Follow these steps:

- 1 Turn your printer on if it's not already on.**
- 2 On the File menu of your Windows program, click Print.**

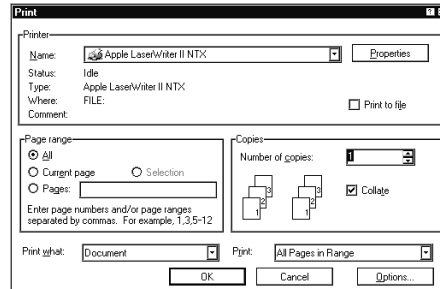

*A sample Print dialog box*

### **3 Click OK to print.**

That's all there is to it. Depending on your application, you may see different messages indicating the status of your print job.

## **Using the CD-ROM Drive**

The CD-ROM drive is easy to use. You insert compact discs into it while the computer is turned on, and change compact discs whenever you want to (as long as the system is not reading from the disc).

Once you insert a CD-ROM into the drive, refer to the documentation provided with the compact disc to perform any necessary installation procedures.

If the diskette drive module is currently installed in the SelectBay, remove it and insert the CD-ROM module, following the instructions in “Swapping SelectBay Modules” on page 114.

## Inserting a Compact Disc

To insert a compact disc into the CD-ROM drive, follow these steps:

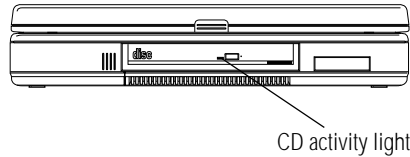

*Locating the CD activity light*

### 1 Make sure the CD activity light is off.

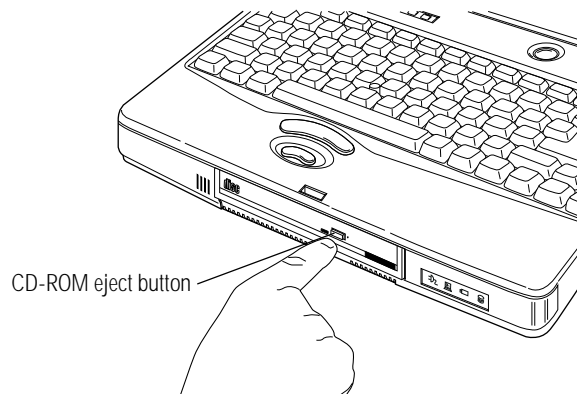

*Pressing the CD-ROM eject button*

### 2 With the computer's power on, locate and press the CD-ROM eject button on the front of the computer.



**NOTE**

*The CD-ROM drive won't open if the computer's power is off.*

The CD-ROM drive slides partially open (about one inch).

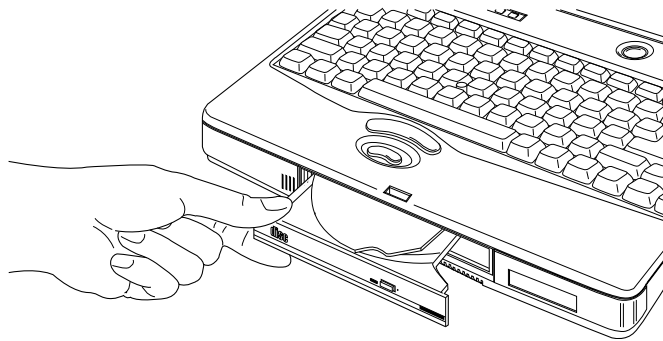

*Opening the CD-ROM drive*

- 3 Grasp the CD-ROM tray and pull the drive until it's fully open.**
- 4 Check the compact disc to make sure it is free of dust before inserting it.**

If the CD is dusty, clean it as described in “Taking Care of Compact Discs” on page 101.

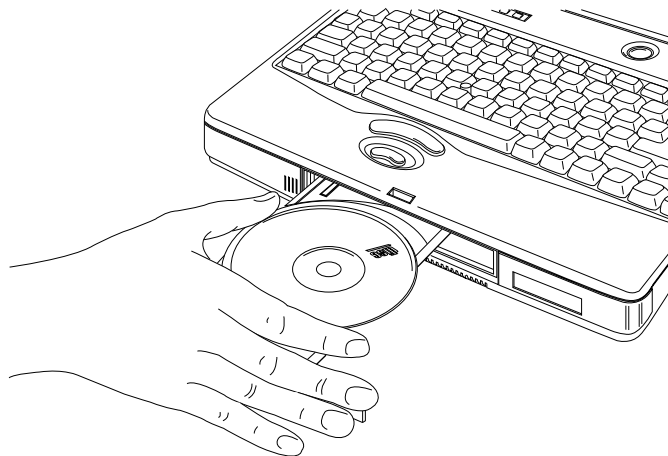

*Placing the compact disc in the drive*

- 5 Carefully place the compact disc in the drive (with the label facing up).**



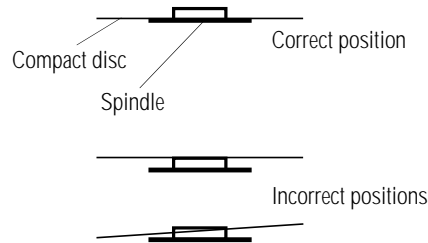

*Positioning the compact disc on the spindle*

- 6 Gently press the compact disc onto the center spindle until you feel it click into place.**

Make sure the disc is completely on the spindle and is lying flat.

If you insert the compact disc incorrectly, it may jam in the drive. If this happens, see your dealer or an authorized service provider for assistance.

- 7 Push the CD-ROM tray in by pressing gently on the center of the tray until it clicks into place.**

You are ready to use the CD-ROM.



*Before moving the computer, even just across the room, remove the CD-ROM from the drive and place it in a safe place where it will not be damaged.*

---

---

## Removing a Compact Disc

To remove a compact disc from the CD-ROM drive, follow these steps:

- 1 Press the CD-ROM eject button on the front of the computer.**

The CD-ROM drive slides partially open.



*The computer must be on for the CD-ROM drive to open. If you need to remove a compact disc and cannot turn the computer on (for example, if the battery is completely discharged), use a slender object, such as a straightened paper clip to press the manual eject button. This button is in the small hole next to the CD-ROM eject button.*

---

- 2 Grasp the sides of the CD-ROM tray and pull the drive until it's fully open.**
- 3 Remove the compact disc and place it in its protective cover.**
- 4 Push the CD-ROM tray in to close the drive.**

## Taking Care of Compact Discs

To protect the data stored on your compact discs:

- ❖ Store your CDs in the containers they came in, to protect them from scratches and keep them clean.
- ❖ Do not bend a CD.
- ❖ Do not apply a label or otherwise mar the surface of a CD.

- ❖ Hold a CD by its outside edge. Fingerprints on the surface of a CD can prevent the drive from reading the data properly.
- ❖ Do not expose CDs to direct sunlight or extreme heat or cold.
- ❖ Do not place heavy objects on top of CDs.

To clean a CD that is dusty or dirty, wipe it with a clean dry cloth. Wipe from the center outwards, not in a circle. If necessary, moisten the cloth with water or a neutral cleaner. Do not use cleaners like benzine or rubbing alcohol. Let the CD dry completely before inserting it in the drive.

## How to Prepare Diskettes for Use

Formatting makes a diskette ready to store files. If you're interested in what's going on when you format a diskette, see "How Does a Disk Store Information?" on page 314.

You can buy two types of diskettes: preformatted and unformatted. Check that preformatted diskettes are formatted for IBM (or DOS).

If you've purchase preformatted diskettes, you don't need the information in this section because the diskette manufacturer has taken care of the process for you. If the package doesn't say anything about formatting, your diskettes are probably unformatted.

This section describes the simplest way to format a diskette. For more options, and an explanation of the other items in the Format dialog box, see Windows 95 Help or your Windows 95 documentation.

To format a diskette, follow these steps:

- 1 If your diskette drive isn't installed in the SelectBay, connect the external diskette drive or swap drives in the SelectBay.**

To swap drives, see "Swapping SelectBay Modules" on page 114.

---

**2 Insert a write-enabled diskette into the diskette drive.**

The **write-protect tab** at the left corner of the diskette must cover the square hole.

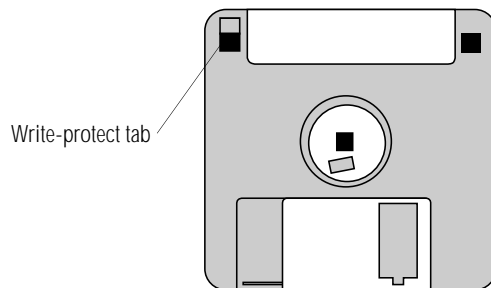

*A write-enabled diskette*



CAUTION

*Formatting a disk erases all information currently on the disk. Do not format a disk unless you're sure it's blank or contains only unimportant files.*

---

**3 Double-click My Computer.**

Windows 95 opens the My Computer window.

**4 Click the icon for the diskette drive (drive A).**



NOTE

*If you double-click the diskette drive icon, Windows 95 will open a window displaying the contents of the diskette. If this happens, close this window before going on to the next step. Windows 95 will not format a disk whose contents are displayed in a window.*

---

**5 On the File menu, click Format.**

Windows 95 opens the Format dialog box.

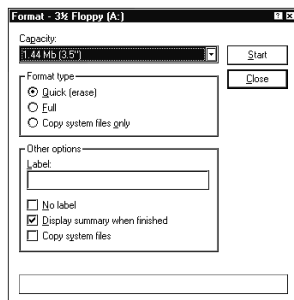

*The Format dialog box*

**6 Make sure the options in the Format dialog box are set correctly, especially the Capacity option.**

You cannot format 720KB diskettes for 1.44MB, or vice versa.

**7 Click Start.**

Windows 95 formats the diskette, displaying the Format Results screen when it's finished.

**8 Click Close.**

**9 Press the eject button and remove the diskette from the drive.**

**10 To format another diskette, insert it into the drive and repeat steps 7 through 9.**

**11 When you've finished formatting diskettes, click Close to exit the Format dialog box.**

**12 Close the My Computer window by clicking its close button.**

---

## Taking Care of Diskettes

To protect the data on your diskettes:

- ❖ Store your diskettes in a suitable container to protect them and keep them clean. You can use the boxes in which the diskettes were supplied, or you can purchase special containers from your computer store.
- ❖ Do not slide back the protective metal cover.
- ❖ Do not touch the magnetic surface of a diskette. Fingerprints can prevent the drive from reading the data held on a diskette.
- ❖ Do not twist or bend a diskette.
- ❖ Keep diskettes at room temperature and don't expose them to direct sunlight. Otherwise data may be lost.
- ❖ Do not place heavy objects on your diskettes.
- ❖ Do not eat, smoke or use erasers near your diskettes. Foreign particles inside a diskette's protective jacket can damage its surface.
- ❖ Keep your diskettes away from speakers, radios, television sets and other sources of magnetic fields which could damage the data on the diskettes.
- ❖ If a diskette is dirty, clean it with a soft cloth moistened in water. *Do not* use cleaning fluids.

## How to Copy Something to a Diskette

Diskettes provide an easy means of transferring files from one computer to another. Copying a file to a diskette also gives you a backup copy in case something happens to the original on your hard disk. This section describes how to use the My Computer icon to copy a file from the hard disk to a diskette.

To copy a file from the hard disk to a diskette, follow these steps:

- 1 If your diskette drive isn't installed in the SelectBay, connect the external diskette drive or swap drives in the SelectBay.**

To swap drives, see "Swapping SelectBay Modules" on page 114.

- 2 Insert a formatted diskette into the diskette drive.**
- 3 Double-click My Computer.**

Windows 95 opens the My Computer window.

- 4 Double-click the folder that contains the file you want to copy.**

As in earlier versions of Windows, you can use the Ctrl and Shift keys to select more than one file.

- 5 Click the file you want to copy.**

You can use the Ctrl and Shift keys to select more than one file.

- 6 Click File, then click Send To.**

- 7 Click the icon for the diskette drive (drive A).**



*You can also copy a file to diskette by clicking the file (or files) you want to copy with the secondary button, then pointing to Send To and clicking 3 1/2 Floppy (A).*

---

Windows 95 copies the file(s).

---

## How to Back Up Your Work

Murphy's law applies to everything—even computers. Therefore, it's a good idea to make periodic copies of everything on your computer's hard disk and store them in a safe place. This is called backing up your files.



DEFINITION

*Murphy's Law: If anything can go wrong, it will, at the worst possible moment.*

---

Your computer comes with Microsoft's Windows 95 backup program pre-installed on the hard disk. Other backup programs are available at many computer stores.

This section explains how to use the Windows 95 backup program to back up the files on your hard disk. Complete information on the backup program is in the on-line Help and your Windows 95 documentation.



NOTE

*Backing up all the files on your hard disk takes a considerable amount of time and lots of diskettes. You may prefer to purchase a high capacity backup system, such as an external tape drive.*

---

To back up your files, follow these steps:

### **1 Attach the backup drive:**

- ❖ If you're backing up your hard disk to diskettes, connect the external diskette drive or install the diskette drive module in the SelectBay.
- ❖ If you're backing up your hard disk to a tape drive or other external device, connect the drive to the computer, following the instructions provided with the drive.



- 2 Click Start, then point to Programs.
- 3 Point to Accessories, then point to System Tools.
- 4 Click Backup.

Windows 95 opens the Backup window.

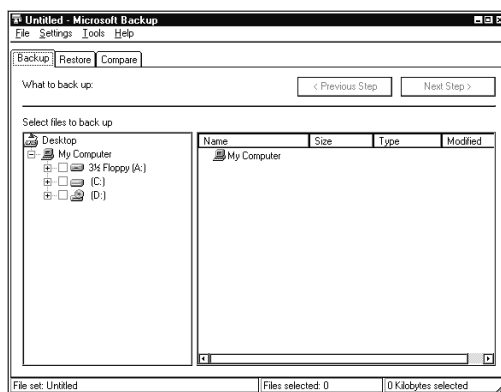

*The Backup window*

- 5 Click the files and folders you want to back up.  
When you select a file or folder, a check mark appears in the check box next to it.
- 6 Click Next Step.
- 7 Select the drive to which you are backing up your files (the diskette drive or any external drive you connected).
- 8 Click Start Backup.
- 9 Type a name for the backup.
- 10 If you are using diskettes, insert new diskettes when Backup instructs you to do so.

---

To restore information from your backup copies to your hard disk, use the Restore page in the backup program. Look in the on-line Help or your Windows 95 documentation for information on restoring files.



*When you're restoring files, the backup program prompts you if you try to overwrite a file that already exists on the hard disk. Make sure the backup version is the one you want before overwriting the existing file.*

---

## Transferring Files to Another Computer

One method for transferring files from one computer to another is to copy them to diskettes. The drawback to this method is that each high-density diskette can only hold 1.44MB.

If you want to transfer a large amount of information, there are better ways. One is to use the Windows 95 briefcase. Another is to use the TranXit™ program, included with your computer, which lets you transfer files through your computer's serial, parallel or infrared ports.



*The steps in this section provide an overview of how to use TranXit to transfer files. For more detailed information about TranXit, refer to the program's on-line help.*

---

To use TranXit to transfer files through:

- ❖ The serial port, you'll need a null modem serial cable.
- ❖ The parallel port, you'll need a LapLink®-compatible parallel cable.
- ❖ The infrared port, you'll need another computer with a compatible internal or external infrared port.

## Set Up Your File Transfer

To set up your file transfer, follow these steps:

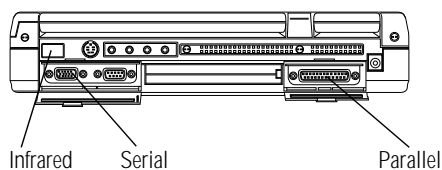

*The back of the computer*

**1 Use one of these methods to make the connection between the two computers:**

- ❖ For a serial connection, connect the serial cable to each computer's **serial port**.
- ❖ For a parallel connection, connect the parallel cable to each computer's **parallel port**.
- ❖ For an infrared connection, aim your computer's **infrared port** directly at the infrared port on the other computer. The two computers must be within 3 feet (1 meter) of each other.

**2 On one of the computers, click Start, then point to Programs.**

**3 Point to TranXit2, then point to TranXit.**

Windows 95 opens the TranXit program.

**4 Choose Connection from the Setup Menu.**

**5 If an appropriate Configured Connection is available, choose it and go on to step 9. Otherwise, continue with the next step.**

**6 Choose the appropriate type of connection in the Connection Type list.**

- 7 **Click the Setup Connection button.**
- 8 **Choose the port setting for the computer and click OK.**
- 9 **Click the Enable Connection check box.**  
An X in the box indicates that a connection is enabled.
- 10 **Click OK to accept the current settings.**
- 11 **Repeat steps 2 through 10 on the other computer, making sure that the connection has been set up identically on both computers.**

## Transfer Your Files

Now that you've set up the connection, it's time to transfer your files. Follow these steps:

- 1 **If you haven't already done so, start TranXit on both computers.**
- 2 **Click the File Transfer tab, bringing the File Transfer page to the front, on both computers.**



The connection status icon (the one that looks like a traffic signal) indicates your connection status:

- ❖ A red light indicates no connection.
  - ❖ A yellow light indicates that TranXit is trying to establish a connection.
  - ❖ A green light indicates that a connection has been established.
- 3 **When the connection status icon is green, open the Options window on one computer.**
  - 4 **If Auto New Window is checked, press Esc to close the Options menu.**

If it is not checked, choose Auto New Window.

**5 Drag the desired file(s) to the destination drive or directory (folder) icon.**

TranXit asks you to confirm the operation.

**6 Click Yes to proceed with the file transfer.**

**7 When you've finished transferring files, click the close button to close TranXit.**

## Connecting to a Network

When you're not carrying your computer around on your travels, you may want to tap into your company's network. This section gives tips on how to connect your computer to an existing network.

Since most of the details in connecting to a network depend upon the network operating system your company uses and the type of cabling or wireless system installed, this section gives only a brief overview specific to your Tecra 740CDT computer. Talk to your network administrator for assistance in getting up and running on your network.

### What Do I Need to Connect to a Network?

Before you can connect to a network, you need to purchase a network adapter card. These come in two forms that will work with your computer:

- ❖ Network adapter PC Card
- ❖ Parallel network adapter

The PC Card runs faster, but takes up one of your PC Card slots. The parallel adapter leaves more space for PC Cards and can be connected so you can still use a parallel printer.

---

## Making the Connection

To connect to a network using a parallel network adapter, refer to the documentation provided with the adapter.

Connecting to a network using a network adapter PC Card requires the following general steps:

**1 Insert the network adapter PC Card into one of the computer's two PC Card slots.**

Windows 95 automatically detects the card and installs the software for it.

**2 Enter the network information.**

Ask your network administrator for the Workgroup name and other requested information.

**3 Click Close.**

Windows 95 copies the necessary network files, then prompts you to restart your computer.

**4 Click Yes.**

Windows 95 restarts and prompts you to enter your name and password.

**5 Type your name and password, then click OK.**

To connect to another type of network, refer to Windows Help, your network adapter documentation, and ask your network administrator for assistance.

## Networks and Suspending the Computer

If you're connected to a network, don't suspend the computer. Not all networks and programs work with Windows 95's Suspend command and Toshiba's Resume Mode. When you turn the computer back on after suspending, you may lose access to your network drives and programs. If this happens, press the reset button to restart your computer.

## Swapping SelectBay Modules

This section provides instructions for changing modules in the computer's SelectBay.

Your computer came with two SelectBay modules: a diskette drive module and a CD-ROM drive module. You may also purchase an optional hard disk drive module.

To use the CD-ROM drive module, you'll have to install it in the SelectBay in the computer or the Desk Station V Plus. The diskette drive module works either in the SelectBay or in the external diskette drive case. Do not insert the CD-ROM drive module into the external diskette drive case.



*Make sure the power is off before you insert or remove a SelectBay module. Inserting or removing a SelectBay module while the computer is on may damage the computer, the module or both.*

---

## Remove the Diskette Drive Module from the External Diskette Drive Case

If you're installing the diskette drive module into the SelectBay, the first step is to remove the diskette drive module from the external diskette drive case.

If the diskette drive module is currently in the SelectBay, the external diskette drive case should be empty. Proceed to the next section.

Follow these steps:

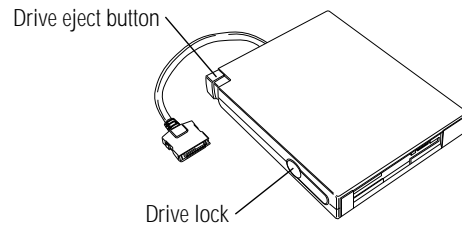

*Releasing the drive module*

- 1 With one hand, press and hold the drive lock.**
- 2 With the other hand, press the drive eject button.**

The diskette drive module partially ejects from the external diskette drive case.

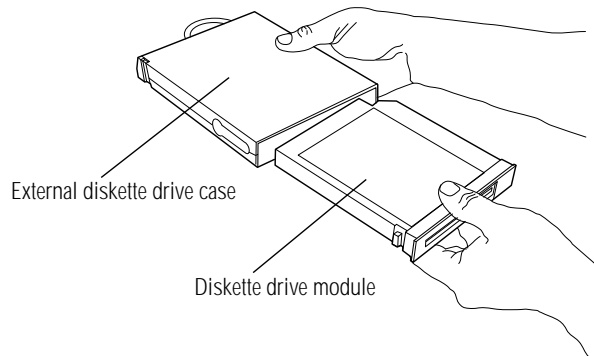

*Removing the diskette drive module*

- 3 Pull the diskette drive module out of the external diskette drive case and set it aside.**



## Prepare the Computer

Follow these steps to prepare the computer for the SelectBay module:

### 1 Shut down the computer.



*Make sure the power is off before you insert or remove a SelectBay module. Inserting or removing a SelectBay module while the computer is on may damage the computer, the module or both.*

---

### 2 Disconnect the power cord and any other cables.

## Remove the SelectBay Module

Follow these steps to remove the SelectBay module:

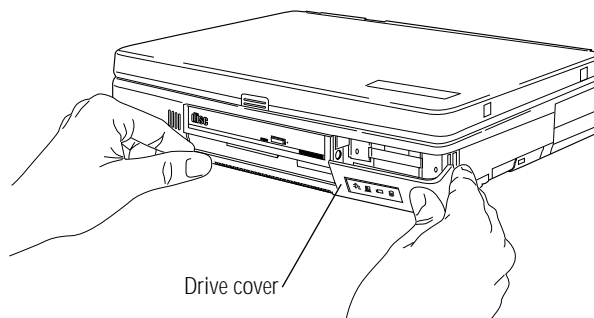

*Opening the drive cover*

### 1 Facing the front of the computer, slide the drive cover to the right and pull it open.



*The drive cover won't open if the front of the computer is resting on a flat surface. Before you can open the drive cover, you'll need to slide the computer towards you so its front edge extends past the front edge of your desk slightly.*

---

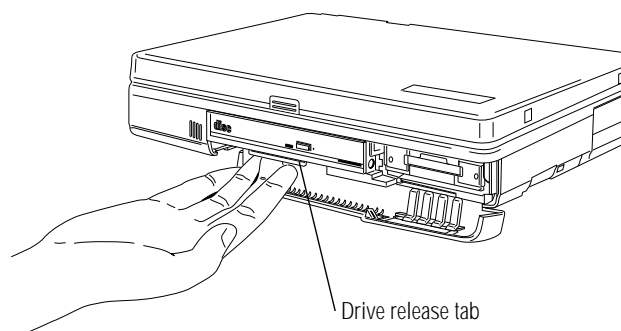

*Pulling the drive release tab*

**2 Pull the drive release tab toward the front of the computer.**

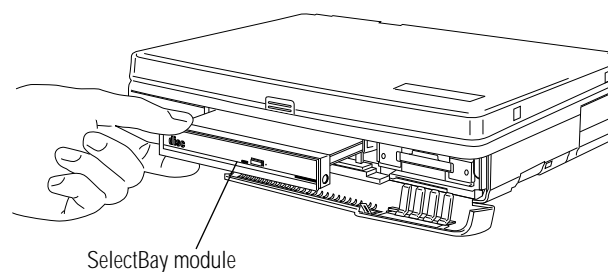

*Removing the SelectBay module*

**3 Remove the SelectBay module.**

**4 If the module you removed from the SelectBay is:**

- ❖ The diskette drive, slide it into the external diskette drive case until you feel it click into place.
- ❖ The CD-ROM drive, set it aside.

## Install the SelectBay Modules

To install the SelectBay module, follow these steps:



*You must install the CD-ROM module into the SelectBay to use it. The external diskette drive case only works with the diskette drive module.*

---

- 1 Insert the SelectBay module into the SelectBay.**
- 2 When you feel the SelectBay module stop, press firmly until it is fully seated in the SelectBay and locks into place.**
- 3 Close the drive cover.**

## Replacing the Hard Disk Drive

The hard disk drive on your Tecra 740CDT can be easily removed and replaced. You can purchase an additional hard disk drive through the Toshiba Accessories Catalog.



*Do not replace your hard disk unless you are knowledgeable about computers and are able to create a new primary hard disk and install an operating system.*

---

## Removing the Hard Disk Drive

Follow these steps to remove the hard disk drive:

- 1 Make sure Resume Mode is turned off.**
- 2 Turn off the computer.**

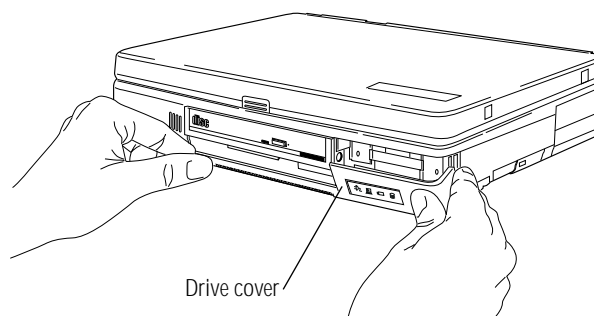

*Opening the drive cover*

- 3 Slide the drive cover on the front of the computer to the right and pull it open.**

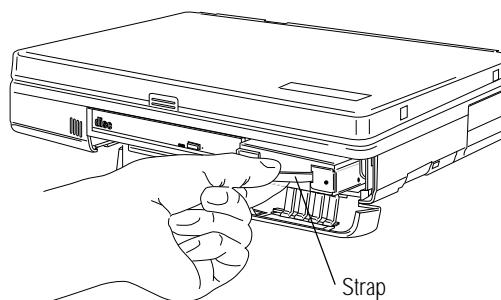

*Removing the hard disk drive*

- 4 Gently pull the strap attached to the drive.**

The drive slides out.

- 5 Close the drive cover.**

## Installing a Hard Disk Drive

- 1 Insert the drive into the hard disk drive slot with the Toshiba label facing down.**
- 2 Slide the drive all the way into the slot.**
- 3 When you feel the drive stop, apply firm pressure to lock the drive in the socket.**

## How and When to Turn the Computer Off

It's a good idea to turn your computer off when you're not using it for a while. There are, however, several things to keep in mind when you turn off the power:

- ❖ In Windows 95, use either the Shut Down or the Suspend command to turn the computer off.

If you plan to leave the computer off for more than eight hours, use the Shut Down command instead.

- ❖ Don't turn the power off if the disk light on the indicator panel is on. Doing so may damage your hard disk, diskette drive or CD-ROM drive.
- ❖ If you close the display panel while the computer is on, it beeps loudly. You can turn this alarm off in TSETUP or in the Toshiba System Control Panel. In TSETUP, this is the Panel Close Alarm option. In the Toshiba System Control Panel, the option is called "Enable audible warning when panel closes." See "TSETUP" on page 427 or "The Toshiba System Control Panel" on page 417 for more information.

## Caring for Your Computer

This section offers easy tips on cleaning and moving your computer. For information about taking care of your computer's battery, refer to "Looking After Your Battery" on page 160.

### Cleaning the Computer

---



*Keep liquid, including cleaning fluid, out of the computer's keyboard, speaker grille and other openings. Never spray cleaner directly onto the computer. Never use harsh or caustic chemical products to clean the computer.*

---

To keep your computer clean, wipe the exterior case and LCD with a lightly dampened cloth.

---

Ask your Toshiba dealer for suggestions for appropriate cleaning products.

## Moving the Computer

Your notebook computer is built to withstand reasonable shock and vibration. Before carrying or transporting your computer, follow these steps:

- 1 Make sure all disk activity has ended (the disk and CD activity lights have stopped glowing).**
- 2 If a diskette is in the diskette drive, remove it.**
- 3 If a compact disc is in the CD-ROM drive, remove it and make sure the drive tray is securely closed.**
- 4 Shut down Windows 95 and turn the computer off.**
- 5 Disconnect the power cord.**
- 6 Disconnect the external diskette drive.**
- 7 Disconnect all external optional devices.**
- 8 Close the display panel.**
- 9 Close all port covers.**



NOTE

*Do not pick up the computer by its display panel or by the back (where the ports are located).*

---

For long trips, transport the computer in a carrying case. You can purchase a carrying case from your Toshiba dealer or through the Toshiba Accessories Catalog.

You can also access the Toshiba Accessories Catalog on line at <http://computers.toshiba.com>.

# Before You Go to a Computer Store

---

If you're new to computers, buying computer equipment (hardware) and programs (software) can be a confusing experience.

This chapter provides advice and explains what you need to know to purchase programs and devices that will work with your Tecra 740CDT computer.

## Buying Programs

The range of entertainment, business and personal programs you can buy is enormous. This section:

- ❖ Gives you an overview of the types of programs you can buy.
- ❖ Discusses the question of integrated packages, such as "Office" suites, versus individual programs.
- ❖ Explains the information on the program's box.

## What Types of Programs Can I Buy?

The following section describes some types of programs that may fit your needs.

### **If You're a Writer**

Almost everyone needs a word processor. This includes professional writers as well as others who use computers for daily correspondence.

To go beyond working with text and create a book, an advertisement or a newsletter, you'll need a desktop publishing program.

If you are a public speaker, a presentation package can help you design professional-looking overheads, handouts, questionnaires and announcements.

### **If You Want to Draw**

If you are a graphics artist or a creative artist, a variety of flexible two- and three- dimensional drawing programs are available. Some require a tablet connected to your computer through the serial port.

### **If You're an Accountant or Financial Analyst**

There are a number of outstanding spreadsheet programs on the market. Professional accounting software is another category you should investigate. The programs available range from general purpose to highly specialized.

### **If You Want to Manage Your Money**

You can choose from a variety of programs for keeping track of your income and expenditure. They range from simple programs for managing family finances to more comprehensive programs that are also suitable for small businesses. In addition there are programs for managing investments.



### **If You're a Designer**

Your computer dealer can introduce you to a variety of sophisticated design programs including programs to design a garden, or to build or remodel a house, as well as the more common Computer Aided Design (CAD) tools.

There are also various specialist programs for use in engineering design.

### **If You're a Researcher or Student**

On-line services such as CompuServe, America Online and Prodigy, and access to the Internet provide almost endless resources for conducting professional research.

In addition, you can purchase dictionaries, and other reference materials on diskette or CD-ROM for your own personal library.

### **Do You Need a Database?**

If you need to keep and update a set of records, such as a list of addresses or a catalogue of items, that is what a database program is designed to do. You could use a database to hold details of a stamp collection or to provide an overall index to the recipes in various cookery books and magazines.

### **Should I Buy an Integrated Package?**

When you have decided which types of program you are interested in, you may find that you can buy some of the programs as a suite. This applies particularly to programs that are widely used in business.

The popular combination of word processor, drawing program and spreadsheet is available in two basic forms—as “Office” suites and as “Works” packages. Some of these also include a database program and/or a communications program.

An Office suite provides the same functionality as the manufacturer's individual programs. In addition it usually includes a set of buttons for swapping between the programs. Some Office suites

also provide a means of easily moving data from one program to another.

Although expensive, an Office suite still works out cheaper than buying all the programs individually. So it is a good choice if you need all the programs it includes.

A Works package is much cheaper than an Office suite. It provides basic wordprocessing, drawing and spreadsheet functions and is excellent value for money provided you don't need any of the features that have been omitted. Typically a Works package supports very few file formats, so transferring files between it and an Office suite can be a problem.

Also, if you are used to a fully functioned word processor (or other program) the lack of features you use regularly can be irritating.

Individual programs have their advantages too. No single manufacturer produces the best program in each category. So you may prefer to buy A's word processor, B's drawing package and C's spreadsheet. All the well-known software companies make sure that their programs can transfer data to and from those of their competitors. And swapping between programs is easy with the Windows 95 taskbar.

Also, an Office suite takes up a lot of space on your hard disk. If you are only going to use a word processor and a drawing package, buying just the two programs you need is the best option.

### **Should I Buy the Diskette or the CD-ROM Version?**

Many programs and most integrated packages are available either on diskette or on CD-ROM.

Loading programs from CD-ROM is faster and more convenient. It saves you the chore of inserting and removing all those installation diskettes, and eliminates the possibility of encountering a damaged diskette in the middle of a multi-diskette software installation.

So buy the CD-ROM version whenever you have the choice.

---

## Understanding the Information on the Box

In addition to listing the features of the product on the box, the manufacturer usually prints the system requirements.

Below is an actual example of the system requirements for a Windows 95-compatible program. Your computer meets all of these requirements.

“Minimum Requirements: Microsoft Windows 95, 8MB of RAM, VGA video adapter, mouse or other pointing device, 55MB free hard disk space”

“Recommended: SVGA video adapter and monitor, sound card and speakers, CD-ROM drive”

The following sections explain each of the characteristics above.

### Windows Compatibility

The computer comes with Microsoft Windows 95. Windows 95 can run programs written for Windows (version 3.0 or later), Windows for Workgroups (all versions), and MS-DOS. When possible, use programs written specifically for Windows 95.

### Processor

The computer has a 166MHz Intel™ Pentium processor with MMX Technology. It will run programs designed for a 286, 386, 486 or Pentium processor.

### Memory

The computer comes with 16MB of EDO DRAM (Extended Data Output Dynamic Random Access Memory). Unless you've added additional memory, use this number when evaluating program requirements. Some programs may list two memory numbers: an amount which is essential for running the program and a recommended amount for better performance.

To check your system's RAM, follow these steps:

- 1 **Click the My Computer icon with the secondary button, then click Properties.**

Windows 95 displays the System Properties dialog box.

- 2 **Click the Performance tab.**

Windows 95 displays your computer's performance status, including the amount of memory installed in your computer.

## Hard Disk

The computer comes with a 2.1 billion byte (2.02 gigabyte) hard drive. Although this capacity well exceeds the 55MB stated in the system requirements example, it is the amount of available hard disk space that matters. Much of your hard disk may already be filled with programs and data.

To determine the available space on your hard disk, follow these steps:

- 1 **Double-click the My Computer icon.**

Windows 95 opens the My Computer folder.

- 2 **Click (don't double-click) the C: icon.**

Windows 95 displays the space remaining (Free Space) and total capacity of the drive at the bottom of the My Computer window. These numbers are listed in megabytes (MB). See "How Big Is a Gigabyte, Anyway?" on page 315 for more information on megabytes.

If you can't see these numbers, widen the window until you can see them. To resize a window, see "Lesson 6: Resizing and Reshaping Windows" on page 63.

---

## Graphics Card

A graphics card is also called a display adapter. It may be a board installed in a desktop computer or a chip, as in your computer. Program requirements are generally listed by the type of adapter or the maximum resolution the adapter supports.

Your display adapter is compatible with the VGA (Video Graphics Array) and SVGA (Super VGA) standards. The adapter has a maximum resolution of 1280 x 1024 pixels. For programs requiring resolutions higher than 1024 x 768, the internal display uses virtual display modes to simulate these resolutions. Using an external monitor lets you take full advantage of the maximum resolution of the display adapter.

See “Changing the Display Mode” on page 308 for information about virtual display modes. See “Using an External Monitor” on page 237 for information on connecting and using an external monitor.

## Sound Card

Your computer has a SoundBlaster/Pro compatible sound card that provides a headphone jack, speaker jack, line-in and line-out jacks, microphone and volume control dial.

## PC Card Slots

Your computer has two stacked PC Card slots, in which you can use Type I, II, or III PCMCIA-compatible PC Cards. These slots also support Zoomed Video and CardBus PC Cards. Refer to “Little Cards that Do Big Things” on page 193 for more information.

## Pointing Device

The AccuPoint is a pointing device that performs all the functions of a mouse.

If a program requires a joystick, you'll have to add one to your system through the optional Desk Station V Plus or NoteDock II Enhanced Port Replicator. Talk to your dealer to find out which joysticks are compatible with your computer.

## Tips on Buying Programs

Before you buy:

- ❖ It's a good idea to see a demonstration of the program.
- ❖ Talk to friends and your company's computer experts about the programs they recommend.
- ❖ Read reviews of programs in the computer press. Articles that compare all the widely available programs of a particular type, such as word processors, are particularly valuable.
- ❖ Get on the Internet and find out what's new.
- ❖ Make sure you have enough space available on the hard disk.

For more information, see "Hard Disk" on page 128.

- ❖ Make sure your computer has enough memory.

For more information, see "Memory" on page 127.

## Installing Programs

Windows 95 makes installing programs onto your computer's hard disk easy. Most programs come with an installation program on diskette or CD-ROM. By following the steps in this section, you'll ensure that your installation program installs the program files completely and sets them up to run with Windows 95.

To install a new program in Windows 95, follow these steps:

**1 Click Start, then click Settings.**

**2 Click Control Panel.**

Windows 95 opens the Control Panel.

**3 Double-click the Add/Remove Programs icon.**

Windows 95 opens the Add/Remove Programs Properties dialog box.

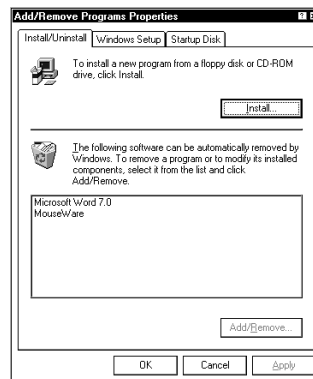

*The Add/Remove Programs Properties dialog box*

**4 Click the Install/Uninstall tab.**

The Install/Uninstall page moves to the front.

**5 Click Install.**

**6 Insert the program's installation diskette or CD-ROM into the drive.**

**7 Click Next.**

Windows 95 searches the installation diskette or CD-ROM for the installation program.

---



*If Windows 95 doesn't find the installation program or searches the wrong drive, click the Browse button and find the installation program manually.*

---

- 8 Click Finish to run the installation program.**
- 9 Continue with the program's normal installation process.**

## Creating a Backup Copy of Program Diskettes

It's important to create backup diskettes for any programs you install on your computer, in case you accidentally damage or lose the original program diskettes. You'll need one blank, formatted diskette for each program diskette you have to copy.

Follow these steps:

- 1 Place the original diskette into the diskette drive.**
- 2 From the desktop, double-click the My Computer icon.**  
Windows 95 opens the My Computer window.
- 3 Click the A: icon.**
- 4 Click File, then click Copy Disk.**
- 5 In the Copy Disk dialog box, click Start.**

Windows 95 copies the files on the diskette into memory and displays a message asking you to insert the destination diskette (the one you're copying to) into the diskette drive.

- 6 Remove the original diskette from the diskette drive and replace it with your blank one.**



**7 Click OK.**

Windows 95 copies the files onto the new diskette.

**8 Repeat steps 1 through 7 for each diskette you want to back up.**

## Buying Hardware

One item of hardware you will almost certainly need, if you don't already possess it, is a printer. Other items you may need include:

- ❖ A network adapter to link your Tecra 740CDT with other computers on a local area network (LAN)
- ❖ An external monitor if several people need to view the screen at the same time
- ❖ A removable hard disk drive for additional storage capacity and increased data security
- ❖ A NoteDock II Enhanced Port Replicator or Desk Station V Plus to simplify connecting your computer to the rest of your system

These items are available as add-on devices for your computer.

### What Kind of Devices Can I Buy?

Many devices, such as removable hard disk drives and network adapters are available as PC Cards, which fit into your computer. For more information about these cards, see "Little Cards that Do Big Things" on page 193.

Other devices, such as printers, are usually too large to be portable and need to be connected to an AC outlet.

The Toshiba Accessories Catalog lists the add-on devices you can purchase from Toshiba. Talk to your dealer about these Toshiba options and other third-party devices.

## Choosing a Printer

There are four main types of printer - impact, inkjet, laser and thermal.

### Impact Printers

In these printers the characters are formed by a printhead hitting the paper. The commonest form of impact printer is the dot matrix with a printhead consisting of 9, 18 or 24 pins.

Dot matrix printers are the cheapest you can buy and also the cheapest to run. But the print quality is inferior to non-impact printers and budget-priced models are slow, typically printing 25-60 characters per second.

Also impact printers are noisy. Although you can fit an acoustic hood to some models to make them quieter, this may make access awkward when you need to replace the paper.

Impact printers are the only type that can handle multipart stationery such as purchase requisitions and delivery notes. However, you would probably need a heavy duty commercial model for this.

To sum up, impact printers are suitable for data listings, particularly if you want to use continuous stationery (an option rarely offered on other types of printer); and they are essential for multipart forms. They are not suitable for correspondence, reports and other documents where print quality is important.

### Inkjet Printers

These printers use bubblejet technology, spraying ink onto paper. Typically, an inkjet printer has a resolution of 300x300 dpi (dots per inch). So print quality is good, though not quite as sharp as laser output because the ink spreads slightly as it is absorbed by the paper.

Monochrome inkjet printers are only slightly more expensive than dot matrix printers. They are much quieter and they print on standard copier-type office paper.

Color inkjet printers are widely available. They work by combining cyan, magenta and yellow inks to produce a full range of colors. To get a really good black though, it's worth choosing a model that has a separate black ink cartridge.

For printing graphics in color, you really need to buy special paper because the amount of ink used causes ordinary paper to wrinkle.

For low volume use at home, an inkjet printer is normally the best choice, particularly if you need the ability to print in color.

## **Laser Printers**

These printers use a laser beam to generate an electrostatic charge that attracts toner to a drum, which transfers the toner onto paper. Because this is a dry process, the toner doesn't spread on the paper, so the resulting image is very sharp and clear.

Print resolutions range from 300x300 dpi on budget machines, to 1200x1200 dpi which gives almost typeset quality for text.

Some laser printers have a duplexing feature, enabling them to print on both sides of the paper without manual intervention.

Color laser printers are becoming available, but are currently very expensive. They use four reservoirs holding cyan, magenta, yellow and black toner.

The initial outlay for a laser printer makes it more expensive than an inkjet for low-volume use. However, if you do enough printing, a laser printer costs less per page than an inkjet and provides higher quality, particularly for graphics.

## **Thermal Printers**

These are specialist color printers for producing presentation quality output. There are two types. Thermal transfer printers melt colored wax onto paper from a ribbon or use wax based inks. Thermal dye printers transfer dye from an impregnated ribbon onto special paper or film.

These printers are too expensive and too slow for normal use.

## Multi-Function Devices

If you are intending to work from home, you probably need a fax machine or a photocopier as well as a printer. Perhaps a scanner would also be useful.

Instead of two or three separate machines, you can buy a multi-function device that prints, copies, scans and faxes. Not only do you save space, but the purchase price and running costs are lower than for a set of stand-alone machines.

Typically, a multi-function device is a printer or fax machine with the other functions added. As a general rule, the quality of printing and faxing is comparable to stand-alone machines. But scanning and copying are done using the fax engine, which has a resolution of 200x200 dpi.

For photocopying, the lower resolution is offset by the use of plain paper, so the copies don't curl and fade.

For scanning, the resolution is adequate for text. But you need a dedicated high-resolution scanner for image editing work.

## Tips on Buying Hardware

- ❖ If a device is cheaper than you think it should be, it may be an older version. On the other hand, depending on your needs, an older version may suit you just fine.
- ❖ Check the warranty and support policy.
- ❖ Make sure the device is supported by Windows 95, or that Windows 95 drivers are provided with the device.
- ❖ If you have access to the Internet, check the World Wide Web and relevant newsgroups for information about the product.
- ❖ Access Toshiba's BBS or the Toshiba Forum on CompuServe (refer to "Contacting Toshiba" on page 360 for instructions) and search for information about using the new hardware with your computer.



# Taking Your Computer on the Road

---

Probably the main reason you bought a notebook computer was so you could use it in a variety of places. This chapter covers all the aspects of running your computer while traveling.

## Toshiba's Energy-Saver Design



Toshiba is a partner in the Environmental Protection Agency's (EPA) Energy Star Program and has designed this product to meet the Energy Star guidelines for energy efficiency.

The computer enters a low-power stand-by state when it is not being used, thereby conserving energy and saving money in the process. It has a number of other features that enhance its energy efficiency.

Many of these energy-saving features have been set by Toshiba. We recommend you leave these features active, so your computer will operate at its maximum energy efficiency.

## Running the Computer on Battery Power

The computer contains a removable Lithium Ion (Li-Ion) battery pack that provides power when you are away from an AC outlet. This is the main battery. You can recharge it many times. If you spend a lot of time traveling and need to work for many hours without an AC power source, you may purchase additional battery packs.

In addition to the main battery, the computer has two other batteries: the backup battery and the real-time-clock (RTC) battery. These are nickel metal hydride (NiMH) batteries.

The backup battery provides the power to store information about the system when you suspend the computer using the Windows 95 Suspend command or Toshiba's Resume Mode. The backup battery maintains this information for up to eight hours after the main battery discharges completely.

The RTC battery stores your system configuration settings and the current time and date information. It maintains this information for up to a month while the computer is turned off.

If you're really curious about these batteries, see "What About the Batteries?" on page 319.

### Charging the Batteries

To charge the main battery while it is in your computer, plug the computer into a live wall socket. The battery charges whether the computer is on or off. It takes approximately four hours to charge the battery with the computer off, or up to twelve and a half hours when the computer is on.

The battery light glows orange while the battery is being charged.

The battery may not start charging immediately under the following conditions:

- ❖ The battery is extremely hot or cold. To ensure that the battery charges to its full capacity, wait until it reaches room temperature (50 to 80 degrees Fahrenheit, 10 to 30 degrees Celsius).
- ❖ The battery is almost completely discharged. Leave the power connected and the battery should begin charging after a few minutes.



*Once a battery pack is fully charged, we recommend you operate your computer on battery power until the battery pack discharges completely. Doing this extends battery life and helps ensure accurate monitoring of battery capacity.*

There are also optional battery chargers available from Toshiba. See “Charging More than One Battery at a Time” on page 162 for more information.

The main battery charges the backup and RTC batteries.

In normal use, the main battery keeps the other batteries adequately charged. Occasionally, the backup and RTC batteries may lose their charge completely, especially if you’ve had the computer turned off for a long time. To recharge:

- ❖ The backup battery, plug the computer in and leave it turned *off* for seven hours.
- ❖ The RTC battery, plug the computer in and turn it *on* for at least twenty-four hours.



## Monitoring Battery Power

The computer's battery light gives you an indication of the main battery's current charge:

- ❖ Green indicates a full charge.
- ❖ Orange indicates the battery is charging.
- ❖ Flashing orange indicates that the charge is running low.

The dashboard section of the Toshiba Access Panel provides gauges that display the remaining battery charge in a variety of formats. This section describes how to use the Toshiba Access Panel to monitor the battery charge. To learn more about this panel, read "The Toshiba Access Panel" on page 375.



*The computer drains battery power more quickly at low temperatures. Check your remaining charge frequently if you're working in temperatures below 50 degrees Fahrenheit.*

---

The computer calculates the remaining battery charge as it operates, based on your current rate of power use. With repeated discharges and recharges, the battery's capacity will gradually decrease. So a frequently used older battery will not power the computer for as long as a new battery, even when both are fully charged. The Toshiba Access Panel gauges indicate 100% charge for both old and new batteries, but the estimated time remaining will be shorter for an older battery.



*Wait at least sixteen seconds after turning on the computer before trying to monitor the remaining battery power. The computer needs this time to check the battery's remaining capacity and perform its calculations.*

---

## Changing the Appearance of the Dashboard



*The dashboard section of the Toshiba Access Panel*

You can set up the dashboard to display the remaining battery charge in five different formats:

- ❖ The Hard Disk Gauge displays the hard disk space usage in LED or bargraph format.
- ❖ The Memory Gauge displays the available GDI, system, or user resources in LED or bargraph format.
- ❖ The Percent Remaining Gauge displays the percentage of battery charge remaining in LED or bargraph format.
- ❖ The Power Meter Gauge displays the computer's power usage in LED or needle format.
- ❖ The Time Remaining Gauge displays the amount of time remaining before the battery discharges completely.

Follow these steps to choose the gauge(s) you want displayed on the dashboard:



- 1 Click the Gauge Gallery button on the Toshiba Access Panel.**

The Gauge Gallery opens.

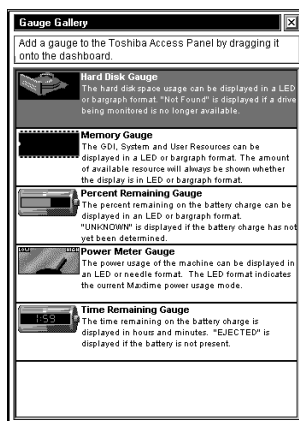

*The Gauge Gallery*

- 2 To add a gauge to the dashboard, simply click on the gauge in the Gauge Gallery and drag it onto the dashboard section of the panel.**

The Toshiba Access Panel displays a shortcut menu, prompting you to choose whether to add the gauge to all configurations, or just the current configuration.

- 3 To add the gauge to the dashboard for all configurations, click Add to All.**

To add the gauge to your current configuration only, click the second menu item (for example, if you're currently using the Home configuration, click Add to Home).

- 4 To remove a gauge from the dashboard, click it with the secondary button.**

The Toshiba Access Panel displays a shortcut menu.

- 5 To remove the gauge from the dashboard for all configurations, click Remove from All.**

To remove the gauge from your current configuration only, click Remove from Home/Office/Travel.

The dashboard shows the gauge(s) you selected.

## Removing the Dashboard from the Toshiba Access Panel

Perhaps you prefer to work with the Toshiba Access Panel hidden, but still want to monitor your current battery charge using the dashboard battery gauges. If so, you can easily remove the dashboard from the Toshiba Access Panel so the gauges display in their own window.

To view the dashboard battery gauges separately from the Toshiba Access Panel, follow these steps:



- 1 Click the dashboard tear-off button on the Toshiba Access Panel.**

The Dashboard window opens and displays the battery gauges.



*The Dashboard window*

- 2 To return the gauges to the Toshiba Access Panel, click the close button.**

## What to Do When the Battery Alarm Sounds

Don't panic.

The Tecra 740CDT computer has three alarms, designed to give you sufficient warning before your battery becomes fully discharged. This section describes the three battery alarms, what they mean and how to set each one to fit your personal computing style.

### Going . . . the Low Battery Alarm

When you're beginning to get low on battery power, the system beeps once and displays the Low Battery Alarm warning. Normally, this means you have less than 20% battery capacity remaining. To change the level of charge that sets off this warning, see "Setting the Alarms" on page 147.

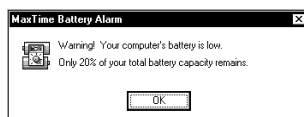

*The Low Battery Alarm warning*

This alarm give you early warning that your battery power is running out. Unless you've told the system to display this message at a really low power level, or your work involves lengthy processing, you can continue with what you are doing.

To close the alarm dialog box, click OK.

### **Going. . . the Critical Battery Alarm**

When you're getting fairly low on battery power, the system beeps once and displays the Critical Battery Alarm warning. Normally, this means you have less than 10% battery capacity remaining. To set the level of charge that sets off this warning, see "Setting the Alarms" on page 147.

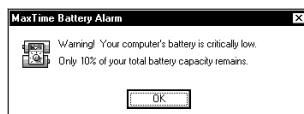

*The Critical Battery Alarm warning*

When this alarm goes off, start planning your remaining battery time carefully. Think about what you absolutely must do before you either find a place to plug in the AC adapter or turn the computer off.

To close the alarm dialog box, click OK.

### **Gone. . . the Emergency Battery Alert**

Now it's serious. When the battery runs down and you have only about five minutes of time left, the computer starts beeping continuously.

When you reach this point, plug the computer into a live power outlet or save all your files and turn the computer off immediately. Doing this ensures you won't lose any work.

If you don't manage to plug the computer in or turn it off before the battery completely runs out of power, the computer automatically enters Resume Mode and turns itself off. Resume Mode keeps track of where you were so, when you turn the power on again, you can continue where you left off.

The computer stores this information until the backup battery runs out of power. If you want to see those unsaved files again, change the battery or find a power outlet within eight hours.

## Setting the Alarms

The Low Battery and Critical Battery alarms sound when the remaining battery charge reaches threshold power levels. The Low Battery Alarm is initially set to 20% of battery capacity. The initial threshold for the Critical Battery Alarm is 10% of battery capacity.

If these threshold levels don't fit your needs, you can change them in the MaxTime Control Panel. To set up the Low Battery and Critical Battery alarms, follow these steps:



*This section provides instructions for setting up the battery alarms in all configurations. If you want the battery alarm settings to be different for each of your configurations, refer to "Changing Battery Alarm Settings" on page 288 for instructions.*

**1 Click Start, then point to Settings.**

**2 Click Control Panel.**

Windows 95 opens the Control Panel.

**3 Double-click the MaxTime icon.**



The MaxTime Control Panel opens with the Power Settings tab on top.

**4 Click the Battery Alarms tab to bring it to the front.**

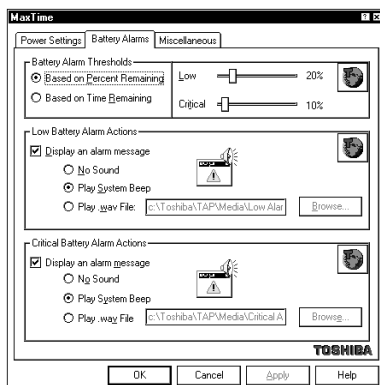

*The Battery Alarms tab of the MaxTime Control Panel*

**5 Select the threshold that will trigger the battery alarm:**

- ❖ To set the alarm to sound when the battery charge reaches the Percent Remaining Threshold, click “Based on Percent Remaining.”
- ❖ To set the alarm to sound when the battery charge reaches the Time Remaining Threshold, click “Based on Time Remaining.”

**6 Select the threshold levels that will trigger the alarms by moving the Low and Critical sliders in the Battery Alarm Thresholds section.**

**7 To configure the system to display a warning message for the Low Battery Alarm, select “Display an alarm message” in the Low Battery Alarm Actions section of the dialog box.**

If you select this option, you can also select a sound event to occur when the Low Battery Alarm warning displays: No Sound, Play System Beep, or Play .wav File.

- 8 To configure the system to display a warning message for the Critical Battery Alarm, select “Display an alarm message” in the Critical Battery Alarm Actions section of the dialog box.**

If you select this option, you can also select a sound event to occur when the Critical Battery Alarm warning displays: No Sound, Play System Beep, or Play .wav File.

- 9 Click OK to save your settings and close the MaxTime Control Panel.**

## Starting Again Where You Left Off

If you want to turn your computer off without going through the startup procedure when you turn it on again, Windows 95's Suspend command and Toshiba's Resume Mode are for you. These features store the current state of the computer, including all your open files and programs, in memory until you turn the computer on again.

The computer uses power supplied by the backup battery to store this information. If the backup battery ever discharges completely (as it will if the main battery has discharged and you leave the computer off and unplugged for over eight hours), your information is lost. So, although suspending will store your open files, you should still save all your work before you turn the computer off.

There are two ways to suspend the computer:

- ❖ Click the Start button, then click Suspend.
- ❖ Turn on Toshiba's Resume Mode and press the power button.

The Windows 95 Suspend feature is the easiest way to suspend the computer. However, you'll have to use Resume Mode if you want to configure your system to:

- ❖ Automatically suspend/resume when you open/close the display panel. This option is available through the Start Up Options tab of the Toshiba System Control Panel, or through TSETUP (in TSETUP, this option is called Panel Power On/Off).



- ❖ Turn off automatically when you haven't used it for a set amount of time. This option is called System Auto Off, and is available through the Power Settings tab of the MaxTime Control Panel, or through TSETUP.

There are two ways to turn on Toshiba's Resume Mode in Windows 95:

- ❖ Use a special key combination (hotkey) to turn on Resume Mode from the keyboard.
- ❖ Use the Toshiba System Control Panel.

The following sections describe how to turn Resume Mode on and off with a hotkey and with the Toshiba System Control Panel.

### Using a Hotkey

To select Resume Mode with a hotkey, follow these steps:

- 1 Press Fn + F3 to display the Resume Mode pop-up window.**

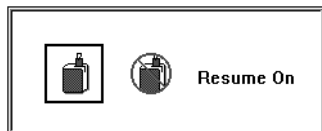

*The Resume Mode pop-up window*

- 2 While continuing to press Fn, press F3 until you select Resume Mode.**
- 3 Release the Fn key.**

You're now in Resume Mode.

### Using the Toshiba System Control Panel

To select Resume Mode using the Toshiba System Control Panel, follow these steps:

- 1 Click Start, then point to Settings.**
- 2 Click Control Panel.**

Windows 95 opens the Control Panel.



**3 Double-click the Toshiba System icon.**

The Toshiba System Control Panel opens with the Start Up Options tab on top.

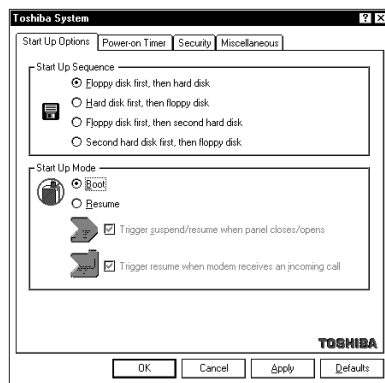

*The Start Up Options tab of the Toshiba System Control Panel*

**4 In the Start Up Mode section, click Resume.**

**5 Click OK to save your settings and close the Toshiba System Control Panel.**

## Changing Batteries

When your battery runs out of power, you have two options: plug in the computer or change the battery if you have a charged spare.



*When handling battery packs, do not drop or knock them. Also be careful not to damage the casing or short-circuit the terminals.*

To change the battery, follow these steps:

- 1 Save your work.**
- 2 Turn the computer off or suspend it according to the instructions in “Starting Again Where You Left Off” on page 149.**

**3 Remove all cables connected to the computer.**

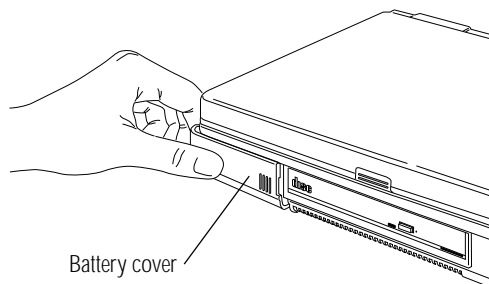

*Sliding the battery cover*

**4 Slide the battery cover to the left.**

Do not attempt to remove the battery cover. It's part of the battery.

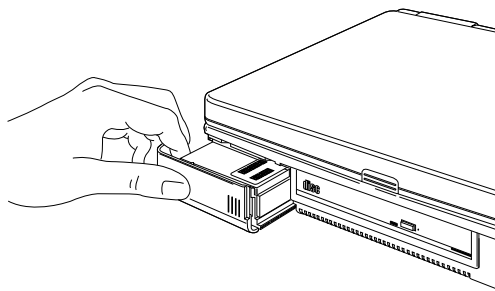

*Removing the discharged battery*

**5 Slide the discharged battery out.**



*If the battery is leaking or its case is cracked, put on protective gloves to handle it, and discard it immediately following the advice in the next section.*

---

**6 Wipe the battery terminals of the charged battery with a clean cloth to ensure a good connection.**

---

**7 Slide the charged battery into the slot.**

The battery pack has been designed so you cannot install it with reverse polarity.

**8 Slide the battery cover to the right and click it into place.**



*Failure to lock the battery cover can result in the battery falling out.*

---

**9 Reconnect any cables you removed.**

**10 Turn the computer on.**

## Disposing of Used Batteries Safely

The life of a battery pack is about 500 recharges, so it should last for years. When the battery pack needs replacing, the battery light flashes orange shortly after you have fully recharged the battery.

You must also discard a battery pack if it has become damaged.

The battery can explode if it is not disposed of properly. So don't simply throw it away. Putting spent batteries in the trash is not only irresponsible, it may also be illegal.

The materials that came with your computer may include an insert regarding the disposal of batteries. If not, check with your local government for information on where to recycle or dispose of old batteries.

If you cannot find the information you need, contact Toshiba for assistance. See "Contacting Toshiba" on page 360 for information on contacting Toshiba offices around the world.

## Conserving Power

How long a fully charged battery pack lasts when you are using the computer depends on a number of factors, such as:

- ❖ How the computer is configured
- ❖ How much you use the hard disk, CD-ROM and diskette drives
- ❖ Whether you use any optional devices to which the battery supplies power
- ❖ Where you are working, since operating time decreases at low temperatures

There are various ways in which you can conserve power and extend the operating time of your battery:

- ❖ Enable Resume Mode, which saves power when you turn the computer off and back on again
- ❖ Use Toshiba's power-saving options

These power-saving options control the way in which the computer is configured. By using them, you can greatly increase the length of time you can use the computer before you need to recharge the battery.

Toshiba has combined these options into preset power usage modes. Using one of these modes lets you choose between maximum power savings and peak system performance. You may also set individual power-saving options to suit your own needs.

The following sections describe how to choose a power usage mode and discuss each power-saving option.

## The Easy Way—Choosing a Power Usage Mode

There are two preset power usage modes:

- ❖ Full power provides maximum system performance, while using the most power.
- ❖ Low power preserves battery charge by reducing overall system performance.

The following table shows the power usage option settings for both power usage modes. The names of these options differ in the MaxTime Control Panel and TSETUP. The TSETUP option names are shown in parentheses.

<i>Power Usage Options</i>	<i>Full Power</i>	<i>Low Power</i>
Processing Speed	High	Low
Sleep Mode (CPU Sleep Mode)	Enabled	Enabled
Display Auto Off	30 Min.	3 Min.
Hard Disk Auto Off (HDD Auto Off)	30 Min.	3 Min.
System Auto Off	Disabled	Disabled
Display Brightness (LCD Brightness)	Bright (with Battery Power)	Semi-Bright (with Battery Power)
	Super-Bright (with External Power)	Bright (with External Power)
Cooling Mode (Cooling Method)	Performance	Quiet

There is also a Custom Settings option (called User Settings in TSETUP) that lets you set the power-saving options individually.

You may set the power usage mode with a hotkey, in the MaxTime Control Panel (if you're working in Windows 95) or in TSETUP (if you're working in MS-DOS). This chapter covers setting the power usage mode with a hotkey and in the MaxTime Control Panel. Using TSETUP to set the power usage mode is discussed in "TSETUP" on page 427.

### Using a Hotkey

To select a power usage mode with a hotkey, follow these steps:

- 1 **Press Fn + F2 to display the power usage pop-up window.**

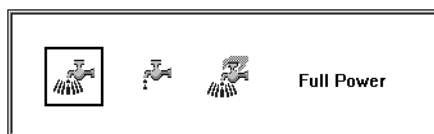

*The power usage pop-up window*

- 2 **While continuing to press Fn, press F2 until you select the desired power usage mode.**
- 3 **Release the Fn key.**

You're now in the selected mode.

### Using the MaxTime Control Panel

To select a power usage mode in the MaxTime Control Panel, follow these steps:

- 1 **Click Start, then point to Settings.**
- 2 **Click Control Panel.**

Windows 95 opens the Control Panel.



- 3 **Double-click the MaxTime icon.**

The MaxTime Control Panel opens with the Power Settings tab on top.

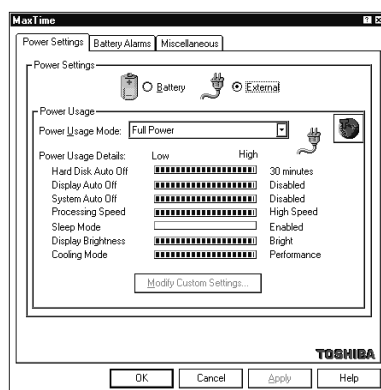

*The Power Settings tab of the MaxTime Control Panel*

- 4 Choose the power source for which you want to set power-saving options:**
  - ❖ To set the power-saving options the system uses when it's running on battery power, click Battery.
  - ❖ To set the power-saving options the system uses when it's running on AC power, click External.
- 5 Click the desired Power Usage Mode setting in the Power Usage Mode list box.**
- 6 Click OK to save your settings and exit the MaxTime Control Panel.**

## Setting Your Own Power Usage Options

If you set the power usage mode to Custom Settings, you can set your computer's power-saving options individually. For example, if you want the computer's processing speed set to its maximum level but want to take advantage of all the other power-saving features, this is the way to do it.

This section describes each of the power-saving options. Settings that save power are indicated with an Energy Star logo.



## Hard Disk Auto Off (HDD Auto Off)

This option saves power by temporarily shutting down the hard disk if it hasn't been accessed for a set period of time. The drive turns back on the next time the computer reads from or writes to it. You have seven choices:



1 Min, 3 Min, 5 Min, 10 Min, 15 Min, 20 Min and 30 Min turn the hard disk drive off if the computer hasn't accessed the hard disk for the time selected.

## Display Auto Off

This option saves power by temporarily shutting down the display if you have not used the keyboard or AccuPoint for a selected period of time. To turn the display back on, press a key or move the AccuPoint. You have eight choices:

Disabled turns the option off.



1 Min, 3 Min, 5 Min, 10 Min, 15 Min, 20 Min and 30 Min blank the display if you haven't used the keyboard or AccuPoint for the selected amount of time.

If you're using an external monitor, Display Auto Off blanks the monitor after the selected time.

## System Auto Off

This option saves power by turning the computer off if it hasn't been used for a selected period of time. This option is available only if Resume Mode is turned on. You have seven choices:

Disabled leaves the computer on until you use the power button to turn it off.



10 Min, 20 Min, 30 Min, 40 Min, 50 Min and 60 Min turn the computer off if you haven't used it for the time selected.

## Processing Speed

This option sets the speed at which the computer processes information. You have two choices:



Low sets a lower processing speed and saves power.

High sets the computer to its maximum processing speed.

## Sleep Mode (CPU Sleep Mode)

This option temporarily shuts down the computer's central processing unit (CPU) when it is inactive. Pressing a key, moving the AccuPoint or a signal from a device returns the processor to its normal operating speed. You have two choices:



Enabled turns CPU Sleep Mode on.

Disabled turns CPU Sleep Mode off.

## Display Brightness (LCD Brightness)

This option saves power by reducing the brightness of the computer's display. You have three choices:



Semi-bright reduces the brightness of the display.

Bright sets the display to medium brightness.

Super-Bright sets the display to its maximum brightness.

## Cooling Mode (Cooling Method)

If the computer's Pentium processor starts to overheat, the CPU fan provides additional cooling to the processor. This option lets you control how active the CPU fan is in cooling. You have two choices:

Performance mode uses the fan to cool the processor chip, maintaining maximum system performance. If the fan turns on frequently, you may want to set this option to Quiet to conserve battery life.



Quiet mode cools the system by temporarily reducing processing speed instead of using the fan.

## Looking After Your Battery

It doesn't take much effort, but by treating your battery right you can make sure it provides maximum power storage for a long time. The following sections offer tips on how to take care of your battery.

### Safety Precautions

- ❖ Never try to disassemble a battery pack.
- ❖ Don't overcharge or reverse charge a battery. Overcharging will shorten its life and reverse charging could destroy it, causing the release of toxic fumes.
- ❖ Don't touch the metal terminals of the battery with another metal object. Short circuiting the battery will cause it to overheat and may do permanent damage.
- ❖ Never incinerate a spent battery as this will cause it to explode releasing toxic materials.
- ❖ If a battery is leaking or damaged, replace it immediately. Use protective gloves when handling a damaged battery.
- ❖ When you need to replace the main battery, use an identical battery from the same manufacturer.

## Five Steps to a Happy Battery

- ❖ Don't leave the computer plugged in and unused for more than a few hours. Overcharging the main battery may shorten its life.
- ❖ If you're not going to use the computer for a long period, remove the battery pack.
- ❖ Alternate between battery packs if you have a spare.
- ❖ Make sure your computer is turned off or in Suspended when you're replacing the battery pack.
- ❖ Store spare battery packs in a cool dry place out of direct sunlight.

## Additional Power Options

Depending on the amount of time you spend away from external power sources, the capacity of one battery pack may be sufficient for your needs. However, if you need more portable power, Toshiba provides two options:

- ❖ You can buy extra battery packs.
- ❖ You can buy a battery charger that charges more than one battery at a time.

## Additional Battery Packs Extend Battery Time

Having one or more extra batteries gives you the opportunity to replace a discharged battery with a charged spare. This can greatly increase the amount of time you can work without having to find a power outlet.

## Charging More than One Battery at a Time

The optional battery charger provides an easy way for you to take more than one charged battery with you when you travel. You can charge up to two spare batteries at a time in the battery charger while continuing to work on the computer.



*Use only Toshiba battery chargers to charge your battery packs. You can order a Toshiba battery charger through the Toshiba Accessories Catalog.*

---

## Charging the Computer's Battery in Your Car

The optional Noteworthy® automobile power adapter lets you plug the computer into the cigarette lighter of your car. This is a great way to charge the computer's battery while driving to your next appointment.

## How about a Carrying Case?

When you're on the road, you'll probably want a way to carry your computer with you. Toshiba offers four choices of carrying cases for the computer:

- ❖ Sturdy fabric carrying case
- ❖ Leather attaché
- ❖ Leather Executive Portfolio
- ❖ Backpack-style case

All of these cases help protect the computer from the bumps and scratches of normal travel. They also provide plenty of extra space for manuals, power cords, CD-ROMs and diskettes.

## Leave the Guide at Home

While you're packing for a trip, you think how nice it would be to be able to leave this heavy guide at home. Fortunately, you can do that without giving up the information you may need.

The entire contents of this guide are available in electronic form on your computer's hard disk. For complete information about using this on-line documentation, see "Using the Electronic Guide" on page 42.

# The Wide World of Multimedia

---

You've heard of multimedia, but what is it? The term *multimedia* refers to the use of two or more communications media (such as text, graphics, sound, animation, and video) to present ideas. A multimedia *title* is the computer presentation of two or more media elements that are experienced simultaneously. You may purchase a multimedia title on compact disc or access one over the Internet.

Unlike television programs or audio tapes, multimedia titles allow you to interact with the information by choosing what to view or listen to and when to see it or hear it.

The Tecra 740CDT computer has everything you need to enjoy multimedia: a CD-ROM drive, a high-speed 166MHz Pentium processor with MMX Technology, video conferencing, a color display, and advanced sound capabilities.

This chapter introduces the multimedia elements you can explore with the CD-ROM supplied with the Tecra 740CDT. Without investing in additional hardware or software, you can, for example, capture a video and keep track of your compact discs.

In addition to the information provided in this chapter, you may wish to read any of the several excellent books that explain multimedia concepts and procedures in detail.

## Building Your Compact Disc Library

Your computer comes with a number of multimedia programs already installed on the hard disk and a library of compact discs. You will want to expand your library to include compact discs to help you at work, at home, in study or recreation.

The information available on compact discs is extensive. Some current examples are:

- ❖ Audio CDs with music
- ❖ Instructional CDs with full motion video
- ❖ Data base CDs with medical books, telephone books, cook-books and other extensive reference material
- ❖ Searchable texts of books, stories, poems, the Bible and other literature
- ❖ Adventure games, fantasy games and simulations
- ❖ Children's stories and learning games
- ❖ Multimedia presentations
- ❖ Photo CDs with your own electronic photographs
- ❖ CDs filled with clip art files
- ❖ CDs with computer programs to help you redesign your home or garden, plan your vacation, balance your budget, chart your stars or raise your child
- ❖ Extensive catalogs of hobbies such as coin collections, astronomical references, and fishing lures
- ❖ Data bases with census data, financial records, maps and charts



---

## Playing a Pre-Installed Compact Disc

For each installed compact disc title, the hard disk holds a small program that displays the title's icon. It does not store the title's content. To view a compact disc:

- 1 Place the disc in the CD-ROM drive.**
- 2 Click Start, then point to Programs.**
- 3 Locate the folder that contains the compact disc icon and title.**
- 4 Click the icon.**

If you click the icon without having the compact disc in the drive, Windows 95 prompts you to insert the disc.

## Adding New Titles

When you buy a new compact disc, always run the installation program that comes with the disc. This program installs the icon that will access the contents of the compact disc.

For more information about managing titles, see "Managing Your CD-ROMs" on page 181.

## Playing an Audio CD

If you insert an audio CD into your CD-ROM drive, Windows 95 loads CD Player, a program that automatically plays the CD. To view the CD Player window, click CD Player on the task bar.

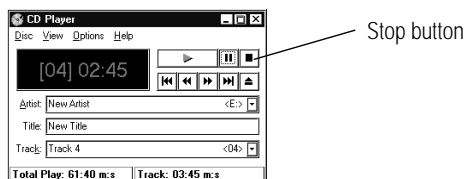

*CD Player playing a CD*

To increase or decrease the volume, turn the dial on the computer's case (located between the speakers above the computer's keyboard).

To stop the CD, click the stop button.

Clicking the CD Player's eject button will open the CD drawer for you, or you can manually open the CD drawer if the computer's power is on.

The Help facility of CD Player explains in detail how to use each component including how to store the name of each track.

If you exit from CD Player and want to start the program again, follow these steps:

- 1 Double-click the My Computer icon.**
- 2 Click the Audio CD icon with the secondary button.**
- 3 Click Play with the primary or secondary button.**

Windows 95 opens the CD Player and starts playing your audio compact disc.

## Playing Back Sound, Video and Animation Files

Multimedia files are stored in a variety of formats depending on the type of file.

### Sound Files

Traditionally, sound is recorded in an analog form. For example, a magnetic tape recorder uses electrical signals to create a single model of a given sound or *waveform*.

Most multimedia computers support two types of sound files, wave files and MIDI files.

### **Digital Audio Wave Files**

Digital audio uses computer-based technology to record, handle and recreate sound. Digital audio systems sample the waveform at fixed time intervals, for example, at 30 times per second, and reduce the sound to a sequence of numbers.

When you play back a digital waveform or wave file, the software transforms the numeric data back into its original acoustic waveform.

If you use the microphone to record sounds, the computer stores them as wave files.

Wave files have the extension .WAV.

### **MIDI Files**

Musical Instrument Digital Interface (MIDI) is a standard language used by composers to create music to be played by a synthesizer. MIDI songs consist of commands, not actual digital sounds. For this reason, the size of a MIDI file is much smaller than a .WAV file.

You can connect an external MIDI device, such as a keyboard with a built-in synthesizer, or you can play MIDI files using the computer's internal synthesizer.

To learn more about the system's MIDI capabilities, look up MIDI in the Windows 95 help index.

MIDI files have the extension .MID.

### **Video and Animation Files**

Full-motion video includes both traditional film and animation. A video plays back on your VCR at 30 frames per second. To play back the same video on your computer would require 9 megabytes of data per second at 640 x 480 resolution.

Since playing back video requires so much data, multimedia applications that use film or animation normally play back at 15 frames per second with a resolution of 320 by 200 pixels. This is why the video on a computer is not as smooth as what you are used to seeing on television.

To reduce the storage required, all video files must be compressed before they can be distributed and decompressed when you view them. Two compression and decompression techniques are in general use.

### AVI Files

The most common technique for storing and playing back video on personal computers is Microsoft's Audio Video Interleaved (AVI) format. This software technique displays video using up to 15 frames per second in a small window.

AVI files have the extension .AVI.



*A frame is a still picture that, when combined with thousands of others, makes a motion picture.*

*Full-motion video means motion pictures played back at 30 frames per second.*

*Interleaving video is the process of displaying every other row of pixels each time the computer refreshes the screen. This increases the rate at which the system updates the screen.*

*A pixel is the smallest dot on your screen that can be controlled by software.*

*Resolution is the number of pixels on the screen.*

---

## MPEG Files

Fifteen frames per second is not adequate for the games and multimedia titles the industry wants to produce. The Motion Picture Expert Group (MPEG) has developed compression and decompression standards that are capable of delivering true full-motion video on your computer.

MPEG files have the extension .MPG.

## Full-Motion Video on the Tecra 740CDT Computer

For best results, MPEG requires specialized hardware to bypass the computer's Central Processing Unit (CPU) and system bus (the backbone of the computer to which all internal devices are connected).

Your computer's PC Card slots are Zoomed Video (ZV) compatible. ZV PC Cards conform to the Zoomed Video standard and provide such services as video capture and the decompression of MPEG-compressed multimedia data (audio and video). To capture video, you need to purchase a ZV PC Card and insert it into the Type II PC Card slot on your computer. Toshiba sells a ZV PC Card, which may be available from your dealer.

Audio and video data flow from the hard disk, a compact disc, the Internet or another source across the system bus to the PC Card controller. The controller passes them to the MPEG decoder on the PC Card, which delivers uncompressed video data back to the PC Card controller.

The PC Card controller then sends a decompressed video stream directly to the video/graphics controller, which displays it on your screen. It sends decompressed audio data directly to the audio sound chip, which controls the speakers.

By bypassing the CPU and system bus, a ZV PC Card can deliver high performance video data at 30 frames per second.

## Play Back Programs

Windows 95 comes with three programs for playing multimedia files:

- ❖ CD Player is used to play an audio CD. The section “Playing an Audio CD” on page 167 explains how to use this program.
- ❖ Media Player is used to play back audio, video and animation files.
- ❖ Volume Control lets you adjust the volume.

## Using Media Player

You can use Media Player to play back wave and Video for Windows files in addition to playing back several other formats such as MIDI and Quick Time for Windows files.

To play a file, follow these steps:

- 1 Click Start and point to Programs.**
- 2 Point to Accessories, then point to Multimedia. Media Player.**
- 3 Click Media Player.**

Windows 95 displays the Media Player window.

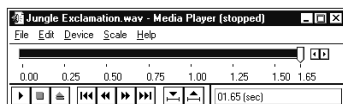

*Media Player ready to play a wave file*

- 4 Choose Open from the File menu.**

- 5 **Locate the file you want to play in the Look in box.**
- 6 **To display the list of file types Media Player can play, click the down arrow next to the Files of type list box.**
- 7 **Click the name of the file you want to play.**



*Another way to play a multimedia file is to click on the file name with the secondary button. This opens a list that includes the Play command.*

## Adjusting the Volume

You can set the volume in two ways:

- ❖ By using the Volume Control program
- ❖ By turning the volume control dial

The Volume Control program sets the volume and balance for playing both CDs and multimedia files that contain sound.

To access this program, follow these steps.

- 1 **Click Start and point to Programs.**
- 2 **Point to Accessories, then point to Multimedia.**
- 3 **Click Volume Control.**

Windows 95 displays the Volume Control mixer window.

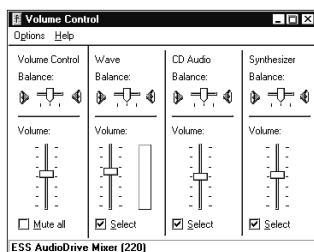

The volume control mixer window

**4 Move the sliders to adjust the volume for the various types of sound files.**



NOTE

To avoid confusion, set all the mixer sliders in the Volume Control program to their medium settings and adjust the volume with the volume dial.

---

## Recording Sounds as Wave Files

You may record sounds through the built-in microphone or, using the microphone jack or line-in jack, from an outside source. This section describes how to record sounds.

### Using the Built-In Microphone

The easiest way to record is through the computer's built-in microphone. To do this, follow these steps:

- 1 Click Start, then point to Programs.**
- 2 Point to Accessories, then point to Multimedia.**
- 3 Click Sound Recorder.**

Windows 95 opens the Sound Recorder window.





**4 Click the record button.**

(It's the red circle at the bottom right of the window.)

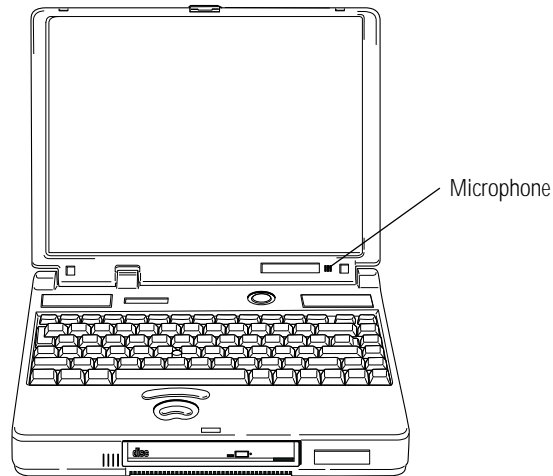

*Locating the built-in microphone*

**5 Speak normally into the microphone.**



**6 When you've finished recording, click the stop button.**

The Audio Recorder window displays a graphical representation of the new sound file as a waveform display.



**7 To hear what you just recorded, click the play button.**

**8 To save the file, choose Save from the File menu.**

## Using an External Microphone

The computer has a built-in microphone for recording sounds. To record higher quality sounds, you may wish to use an external microphone. To attach an external microphone, follow these steps:

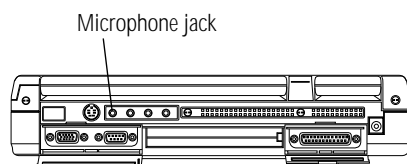

*The microphone jack*



- 1 Locate the microphone jack on the back of the computer.**
- 2 Plug the microphone cord into the microphone jack.**
- 3 Turn the microphone on.**

The internal microphone is automatically disabled.

Once the external microphone is connected, the recording process is the same as with the built-in microphone. See “Using the Built-In Microphone” on page 174 for instructions.

## Using an External Audio Input Device

To record sounds from an external audio device, such as a stereo amplifier, tape deck, or CD player, follow these steps:

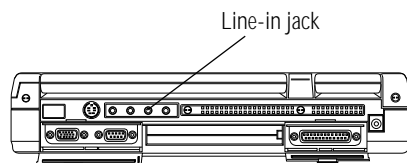

*The line-in jack*



- 1 Locate the line-in jack on the back of the computer.**
- 2 Using any necessary adapters, plug the cord from the audio device into the line-in jack.**

Once the external audio device is connected, the recording process is the same as with the built-in microphone. See “Using the Built-In Microphone” on page 174 for instructions. To adjust the quality of the recording, see “Adjusting Recording Quality” on page 178 for information.

## Recording From the Computer’s CD-ROM Drive

To record from a CD, follow these steps:

- 1 Insert the CD from which you wish to record into the computer’s CD-ROM drive.**

Windows 95 starts the CD Player program automatically.



- 2 Double-click the speaker icon in the lower right corner of the Windows 95 taskbar.**

Windows 95 displays the Volume Control Mixer window.

- 3 In the Options menu, click Properties.**

Windows 95 displays the Properties dialog box.

- 4 In the Adjust volume for section of the dialog box, select “Recording.”**

You can choose from six volume controls:

- ❖ Recording Control
- ❖ Line in
- ❖ Microphone
- ❖ CD Audio
- ❖ Synthesizer
- ❖ Aux B

- 5 Make sure the boxes next to CD Audio and Recording Control are selected.**

- 6 Click OK.**

This leaves the mixer open on the desktop with the recording controls displayed.

- 7 In the CD Audio section of the window, select the check box next to Select.
- 8 In the Options menu, click Advanced Controls.
- 9 Click Advanced.

Windows 95 displays the Advanced Controls for Recording Control dialog box.

- 10 Select the check box next to Recording Input Monitor, then click Close.

The Recording controls are now set to record from the CD-ROM drive in your computer. Next, you need to start Sound Recorder to begin recording from your CD. Follow these steps:

- 1 Click Start, then point to Programs.
- 2 Point to Accessories, then point to Multimedia.
- 3 Click Sound Recorder.

Windows 95 opens the Sound Recorder program.



- 4 With the audio CD playing, click the record button on the Sound Recorder.

A volume meter displays in the recording balance panel of the Recording Control window. Adjust the recording level by sliding the handle up or down.



TECHNICAL  
NOTE

*To avoid distortion, make sure the volume meter display does not turn red while you are recording.*

---



- 5 When you've finished recording, click the stop button on the Sound Recorder.

## Adjusting Recording Quality

You can adjust the quality of your recordings. However, the better the quality of the recording, the more disk space the sound file will require. Experiment to find a balance that fits your needs.

To adjust the recording quality, follow these steps:

- 1 If you already have the Sound Recorder open, skip to step 5.**
- 2 Click Start, then point to Programs.**
- 3 Point to Accessories, then point to Multimedia.**
- 4 Click Sound Recorder.**

Windows 95 opens the Sound Recorder window.

- 5 Click Edit, then click Audio Properties.**

Sound Recorder opens the Audio Properties dialog box.

- 6 Adjust the Recording Volume, Preferred device and Preferred quality according to your needs.**

- 7 Click OK.**

Your new settings will take effect the next time you record.

## Using External Speakers or Headphones

To play back sound files through an external device such as headphones or stereo speakers, follow these steps:

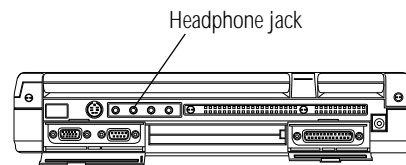

*The headphone jack*



- 1 Locate the headphone jack on the back of the computer.**
- 2 Using any necessary adapters, plug the cord from the external audio device into the headphone jack. The headphone jack requires a 16-ohm stereo mini-jack.**
- 3 To adjust the volume, follow the steps in “Adjusting the Volume” on page 173.**

## Using an External Audio Device

You can record or play back sounds from the computer by connecting the computer to an external audio device, such as a tape recorder or stereo amplifier. To connect an external audio device, follow these steps:

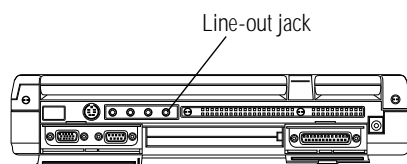

*The line-out jack*

- 1 **Locate the line-out jack on the back of the computer.**
- 2 **Using any necessary adapters, plug the cord from the external audio device into the line-out jack.**
- 3 **To adjust the volume, follow the steps in “Adjusting the Volume” on page 173.**

## Video Conferencing

Your Tecra 740CDT computer came equipped with the Noteworthy Business Video Phone with Intel ProShare Technology. Using this exciting video conferencing package, you can initiate and receive video calls from anyone equipped with a computer and video conferencing software.

To set up and use the Noteworthy Business Video Phone, refer to the *Noteworthy<sup>®</sup> Business Video Phone with Intel<sup>®</sup> ProShare<sup>®</sup> Technology User's Guide*, provided with your computer.

## Multimedia Options that Require Additional Equipment

You can capture video by purchasing an ISA or PCI video capture adapter and installing it in the optional Desk Station V Plus. You will also need specialized software to edit your captured video.

To create an animation you need special graphics software.

To compose and play back sounds using the MIDI language you need additional equipment including a synthesizer.

## Managing Your CD-ROMs

If you have a large number of CD-ROMs, you might find yourself wishing there were an easy way to keep track of what's on all of them. That's where Toshiba's magiCDisc™ CD-ROM management program comes in.

With magiCDisc, you can launch an associated program whenever you insert a CD-ROM into the drive. You can search for a specific CD-ROM by title, category or other key word, and look at only CD-ROMs of a particular type, such as data, audio or photo. If a CD-ROM includes programs to install on your hard disk, you can start the installation program from magiCDisc. You can also use magiCDisc to browse through and sample the multimedia files (sound, animation and graphical images) on a CD-ROM.

### Opening magiCDisc

To open magiCDisc:

- 1 Click Start, then point to Programs.**
- 2 Point to magiCDisc.**
- 3 Click magiCDisc.**

There are two primary screens in magiCDisc. The main screen is shown below. The other is the CD Rack, which contains a list of your CD-ROMs. The CD Rack is described in "Looking at a List of CD-ROMs" on page 185.

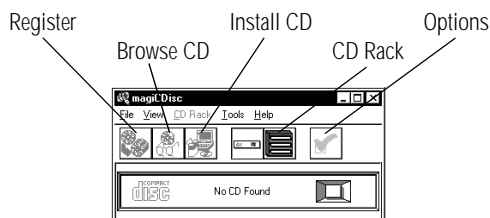

*The main screen*

From here, you may perform a number of tasks:

- ❖ You can add the CD-ROM to your list by choosing the **Register** button. See “Adding a CD-ROM to the List” on page 183.
- ❖ You can look through the files on the CD-ROM and play one or more of them by choosing the **Browse CD** button. See “Looking at and Playing the Files on a CD-ROM” on page 186.
- ❖ If the CD-ROM contains files that need to be installed on your hard disk, you can start the installation process by choosing the **Install CD** button. See “Installing Programs from a CD-ROM” on page 187.
- ❖ You can view your list of CD-ROMs by choosing the **CD Rack** button. See “Looking at a List of CD-ROMs” on page 185.
- ❖ You can customize magiCDisc by choosing the **Options** button. See “Changing How magiCDisc Operates” on page 188.

## Inserting a New CD-ROM

The first time you insert a CD-ROM into the drive, magiCDisc displays the Inspector dialog box.



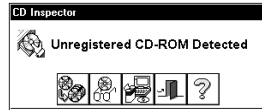

*The Inspector dialog box*

This dialog box informs you that you have not previously registered the current CD-ROM. It also includes magiCDisc tools that let you register, browse or install the CD-ROM. This dialog box opens automatically, relieving you of the need to remember whether a CD-ROM is registered or not.

## Adding a CD-ROM to the List

To add a CD-ROM to your list, follow these steps:



- 1 Click the Register button in the Inspector dialog box or from the magiCDisc toolbar.**

The Edit Registration dialog box opens.

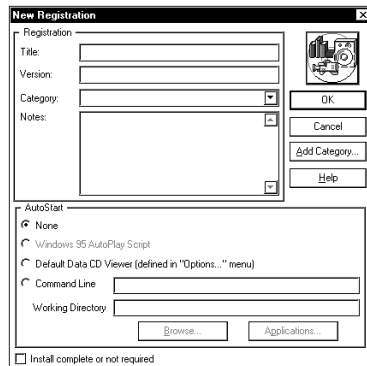

*The Edit Registration dialog box*

There are three types of CD-ROMs: data, audio and photo. The system determines the type of your CD-ROM and displays the appropriate icon in the upper right corner.

The options in the dialog box are different depending on the CD-ROM type.

**2 Enter a title and version (data CD), artist (audio CD) or date (photo CD).**

**3 Use the Category drop-down list box to enter a category.**

To add a new category, click Add Category.

**4 Type in any additional information in the Notes box.**

**5 Select None if you don't want the system to start a program automatically when you insert the CD-ROM.**

Select Windows 95 AutoPlay Script to run the associated AutoPlay script file on the CD-ROM when you insert the CD-ROM. This option is available only if the CD-ROM being registered supports the Windows 95 AutoPlay script capability.

Select Default Media Player to start the default media player (defined on the Media Players tab of the Registration Options dialog box) each time you insert a CD-ROM. This option lets you change or upgrade the media player for all CD-ROMs of a specific type, rather than changing the AutoStart settings for each individual CD-ROM. To define the player, see "Customizing the Media Player" on page 190.

Select Command Line to start a specific program when you insert the CD-ROM into the drive. Enter the exact command and working directory into the indicated boxes or use the Browse or Applications buttons to locate the program.

**6 Click OK to complete the registration process and close the Registration dialog box.**

That's all there is to it. The next time you look at the rack screen, your new CD-ROM will appear in the list (unless you've set the rack screen to display only CDs of a different type).

## Looking at a List of CD-ROMs



To examine a list of your registered CD-ROMs, click the CD Rack button on the main screen. The rack screen opens.



*The rack screen*

If you've registered a large number of CD-ROMs, you may want to limit how many are shown in the rack screen. You can set this through the CD Rack menu, as described below:

- ❖ To show all your CD-ROMs, choose Display All CDs from the CD Rack menu.
- ❖ To show only one type of CD-ROM, choose Display *type* CDs only from the CD Rack menu, where *type* is Data, Audio or Photo.
- ❖ To show all the CD-ROMs in one or more categories, choose Search by Category from the CD Rack menu. This opens the Search by Category dialog box. Select the desired category or categories from the list and click OK.
- ❖ To display those CD-ROMs whose descriptions use a key word, choose Search by Text from the CD Rack menu. This opens the Search for Text dialog box. Enter one or more key words separated by semicolons (;) into this box and click OK.
- ❖ To show all the CD-ROMs of the selected type, (all, data, audio or photo), click Clear Previous Search.

The toolbar buttons are the same as those on the main screen. However, the Register, Browse and Install buttons have no effect unless you select a CD-ROM from the list. See the next section for details.

## Selecting a CD-ROM from the List

To select a CD-ROM from the list, click it. Once an item is selected, you can:



❖ Modify the registration information for the CD-ROM by choosing the Register button. You can change this information at any time. See “Adding a CD-ROM to the List” on page 183.



❖ Browse through multimedia and data files on the CD-ROM and play one or more of them by choosing the Browse button. You cannot browse an audio CD-ROM. You can only browse the CD-ROM you selected in the rack if it is the same as the one in the drive. See “Looking at and Playing the Files on a CD-ROM” on page 186.



❖ Install the CD-ROM by choosing the Install button. You can only install the CD-ROM you selected in the rack if it is the same as the one in the drive. See “Installing Programs from a CD-ROM” on page 187.

## Looking at and Playing the Files on a CD-ROM

To look through a list of files on a CD-ROM, follow these steps:



**1 Click the Browse button. This button is available in the both the main and rack screens, and in the Inspector dialog box. You can only browse the CD-ROM if the CD-ROM selected in the rack is the same as the one in the drive.**

The CD-ROM Browser opens.



*The initial CD-ROM Browser*

**2 Click the Audio, Video, Image, Animation or Data button to search for files of a particular type.**

The extended CD-ROM Browser opens.

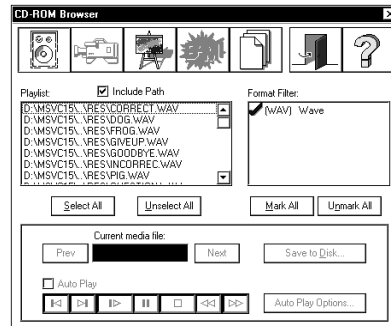

*The CD-ROM Browser*

**3 Select one or more files in the playlist.**

To select more than one file, press Ctrl as you click files beyond the first. To select several adjacent files, press Shift when you click the second and subsequent files.

**4 Click the Play button to play the file.**

Choosing the Next and Previous buttons moves you forward and backward through the selected files in the playlist.

To play all the selected files in the playlist, select AutoPlay before choosing the Play button. Click the AutoPlay Options button to set how the multiple files play. For example, you can set magiCDisc to limit the play time for each file.

**5 When you've finished playing your files, click the Close button to close the CD-ROM Browser.**

## Installing Programs from a CD-ROM



Many CD-ROMs have programs that you must install onto the hard disk. To install these files through magiCDisc, click the Install CD icon on the toolbar. The magiCDisc program searches for the CD-ROM's installation program and lets you start it. If there is more than one installation program, magiCDisc offers you a choice between them.

## Changing How magiCDisc Operates

So far, you've seen how to manage your CD-ROMs with all of magiCDisc's settings set to their original values. However, you can customize many features of magiCDisc to fit your needs.

### Customizing the Inspector

To customize how the Inspector operates, follow these steps:



- 1 Click the Options button on the main or rack screen.**

The Registration Options dialog box displays with the CD Inspector page selected.

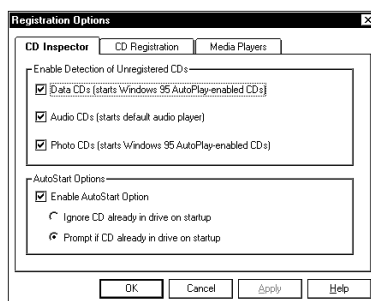

*The CD Inspector page*

- 2 To enable the Inspector for unregistered CD-ROMs, click the check box next to each desired type.**

If the unregistered CD-ROM contains a Windows 95 AutoPlay script, the Inspector executes the script. If no Windows 95 AutoPlay script is found on the CD-ROM, the Inspector dialog box opens.

If the disc is an unregistered audio CD-ROM, the Inspector launches the default audio player.

- 3 To automatically start programs when you insert a registered CD-ROM, click the box next to Enable AutoStart Option. A check appears in the box when the option is enabled.**



*If this option isn't set, registered CD-ROMs won't start programs automatically, even if the AutoStart option is selected in the individual CD-ROM's registration information.*

- 4 Click OK to close the Options dialog box with your settings in effect.**

## Customizing CD-ROM Registration

To customize the registration process, follow these steps:



- 1 Click the Options button from the main or rack screen.**

The Registration Options dialog box displays with the CD Inspector page selected.

- 2 Click the CD Registration tab to move to the CD Registration page.**

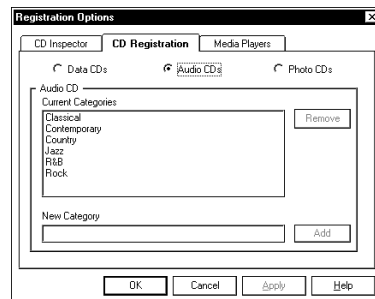

*The CD Registration page*

- 3 Choose one type of CD-ROM to display the current categories for that type.**

**4 Change the list of categories as necessary:**

- ❖ To remove a category, select it and click the Remove button.
- ❖ To add a category, click the Add Category button.

**5 Click OK to close the Registration Options dialog box with your settings in effect.**

### Customizing the Media Player

Setting a default media player lets you change or upgrade the media player for all CD-ROMs of a specific type, rather than changing the AutoStart settings for each individual CD-ROM.



*Setting the default media player only affects an individual CD-ROM if AutoStart is set to Default Media Player in the CD-ROM's registration information.*

---

To set the default media player for each type of CD-ROM, follow these steps:



**1 Click the Options button from the main or rack screen.**

The Registration Options dialog box displays with the CD Inspector page selected.

**2 Click the Media Player tab to move to the Media Player page.**



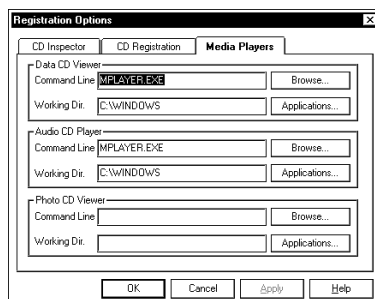

*The Media Player page*

- 3 Enter the Application name and Working Directory for the player of each type of CD-ROM (Data, Audio and Photo). You may use the Browse or Applications buttons to locate and select the desired media player.**
- 4 Click OK to close the Registration Options dialog box with your settings in effect.**

# Little Cards that Do Big Things

---

PCMCIA-compatible PC Cards greatly increase the capabilities of your computer. These cards pack all the performance of full-sized expansion cards into a case the size of a credit card.

There are three types of PC Card: Type I, Type II, and Type III. The difference between each type is the card size. Your computer comes with two stacked PC Card slots that let you install up to two Type I or Type II cards or one Type III card (Type III cards are much thicker). When you buy a PC Card, check the package for the Type of card you're buying.

In addition, your computer's PC Card slots support Zoomed Video (ZV) cards and CardBus cards, allowing you to use PC Cards that comply with these standards.

This chapter describes the different types of PC Cards, tells you how to install PC Cards and provides general tips on using them. Since each card is different, you'll have to read your cards' documentation to use the card, but this chapter will help you get started.

---



*If your PC Card came with a diskette, read "Programs that Make Your PC Card Work" on page 196 before installing any of its programs. The programs on the diskette may conflict with pre-installed Toshiba files designed specifically for your computer.*

---

## What Do PC Cards Do?

New PC Cards are being introduced every day. Among the PC Cards currently available are:

- ❖ Modems and fax/modems
- ❖ Cellular modems
- ❖ Network adapters
- ❖ Hard disk and solid state memory drives
- ❖ Memory
- ❖ SCSI adapters
- ❖ Global Positioning System (GPS) receivers
- ❖ Zoomed video (ZV) PC Cards
- ❖ CardBus NIC
- ❖ CardBus SCSI
- ❖ Video Conferencing CardBus Card

---

Some PC Cards combine the functions of several different cards. One popular example is a PC Card that combines a fax/modem with a network adapter. These are handy if you want to get the most out of your PC Card slots.



*PC Card technology has changed considerably over the last few years and it's important that your card is current with the times. Check the package to make sure the PC Card you buy conforms to the PCMCIA 2.01 standard (or later). Cards not conforming to this standard may work with your computer, but are likely to be much more difficult to set up and use.*

---

## Cards You Can Buy From Toshiba

Toshiba's Noteworthy PC Cards are specifically designed to work with your computer and are available from your Toshiba dealer. Noteworthy PC Cards include:

- ❖ Fax/Modems
- ❖ Cellular modems
- ❖ Removable hard disk drives
- ❖ Token ring network adapters
- ❖ Ethernet network adapters
- ❖ SCSI adapters
- ❖ Global Positioning Systems (GPS)
- ❖ Zoomed Video (ZV) PC Cards
- ❖ CardBus Ethernet
- ❖ Video Conferencing CardBus Card

## Programs that Make Your PC Card Work

PC Cards require Card and Socket Services software. While this title sounds rather complex, it's nothing to worry about—it's merely a set of programs that acts as a translator between the PC Card and the computer, and makes hot swapping (switching cards while the computer is on) possible.

Windows 95 comes with Card and Socket Services programs already installed. To ensure complete compatibility with all the features of Windows 95, use the built-in Card and Socket Services programs rather than the version that came with your PC Card.

In addition to the built-in Windows 95 Card and Socket Services programs, your Tecra 740CDT came with CardWorks Card and Socket Services pre-installed. The CardWorks software provides support for Zoomed Video PC Cards, and helps you monitor your PC Cards.

To set up Windows 95 for your PC Card, see “Setting Up Your PC Card for Your Computer” on page 201.

## PC Cards and Suspending the Computer

Toshiba's Card and Socket Services software is designed to support Toshiba's Resume Mode and Windows 95's Suspend command. If you use another manufacturer's software instead, the system may not recognize your PC Card when you turn the computer on in Resume Mode.

If this happens, shut down the computer and restart it. The system will recognize the card.

---

## Hot Swapping

One of the significant features of PC Cards is that you can replace one PC Card with another even while the computer is on. This is called “hot swapping.” For example, if you want to switch between a hard disk and a video conferencing card, you can do it while you’re working without turning the computer off and back on again.

While you can insert a PC Card at any time, applying a bit of common sense about when you remove a card will make your computing life much happier. Just remember not to remove a card while it’s in use. You probably won’t break anything, but you could lose valuable information.



*You cannot hot swap a CardBus PC Card with a Zoomed Video PC Card (or vice versa), since these card types require different PC Card Controller Mode settings. Refer to “Using a Zoomed Video PC Card” on page 199 for more information.*

---

Some examples:

- ❖ Use Windows 95 to stop the PC Card before removing it, according to the instructions in “Removing a PC Card” on page 202. This provides extra assurance that the card swap will be problem-free.
- ❖ Do not remove a hard disk card while the system is accessing the card.
- ❖ Do not remove a SCSI card while any of the SCSI devices are operating.
- ❖ Do not remove a network card while you are connected to the network.

## Inserting PC Cards

OK. You've bought your first PC Card and want to install it. This section describes how to install the card.

Before you insert your PC Card, read through the documentation that comes with the card to see if you need to do anything before you insert it.



---

*Your Tecra 740CDT computer came with all the Card and Socket Services programs you need. Even if your PC Card comes with its own version of Card and Socket Services, you should use the files provided on your computer.*

---

You may insert Type I or Type II cards into either the upper or lower slot. You may only insert a Type III card into the lower slot. Inserting a Type III card takes up all the space for both slots—you cannot have a Type III card installed with any other card.

To insert a PC Card, follow these steps:

- 1 Locate the PC Card slot cover on the right side of the computer.**

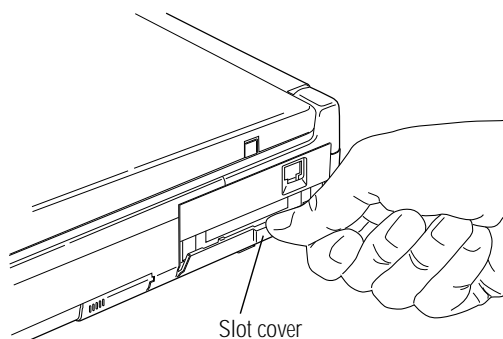

*Opening the PC Card slot cover*

- 2 Open the PC Card slot cover.**

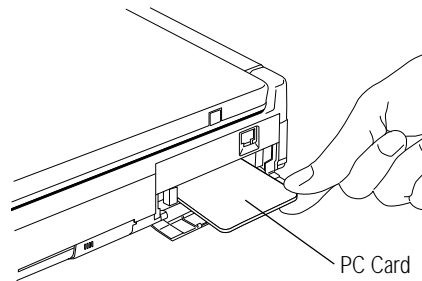

*Inserting a PC Card*

**3 Insert the PC Card.**

If you have a Type III card, insert it into the lower part of the slot. If you have a Type I or Type II card, insert it into either the top or bottom half of the slot.

**4 When the card is almost all the way into the slot, push firmly, but gently, to ensure a firm connection with the computer.**

Do not force the card into position.

## Using a Zoomed Video PC Card

Your computer came with the PC Card Controller Mode set to 16-Bit/CardBus. This mode supports both CardBus PC Cards, like the Video Conferencing CardBus Card provided with your computer, and standard 16 bit PCIC cards. It does not support Zoomed Video PC Cards. In order to use your Zoomed Video PC Card, you'll need to change this mode (in TSETUP or the Toshiba System Control Panel) to PCIC.



Once you've changed the PC Card Controller Mode to PCIC, you can use either Zoomed Video PC Cards or standard 16 bit PC Cards in your computer's PC Card slots.



*Since Zoomed Video PC Cards require a different PC Card Controller Mode than CardBus cards, you cannot use these two types of cards simultaneously.*

To change the PC Card Controller Mode and use your Zoomed Video PC Card, follow these steps:

- 1 Click Start, then point to Settings.**
- 2 Click Control Panel.**

Windows 95 opens the Control Panel.



- 3 Double-click the Toshiba System icon.**

The Toshiba System Control Panel opens.

- 4 Click the Miscellaneous tab to bring it to the front.**

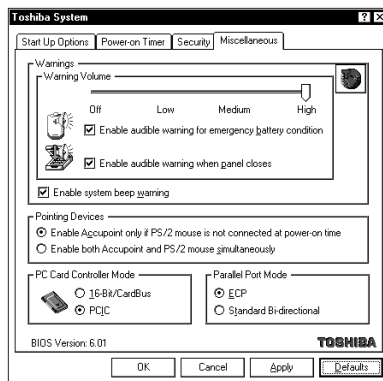

*The Miscellaneous page*

- 5 In the PC Card Controller Mode section, select PCIC.**
- 6 Click OK to exit the Toshiba System Control Panel.**

The system displays a Toshiba System Settings Change dialog box that prompts you to restart your computer.

**7 Click Yes.**

The system shuts down and restarts.

**8 Insert your Zoomed Video PC Card into one of the computer's PC Card slots, following the instructions in "Inserting PC Cards" on page 198.**

Refer to the documentation provided with your Zoomed Video PC Card to set up and use the card.

To use a CardBus PC Card once you've finished using your Zoomed Video PC Card, repeat the steps above, selecting 16-Bit/CardBus as the PC Card Controller Mode.

## Setting Up Your PC Card for Your Computer

Some PC Cards are ready to use as soon as you install them. Others, such as hard disk cards, network cards and SCSI adapters, may require some additional work to set them up to work for your computer.

Windows 95 makes setting up your PC Cards quick and easy. When you insert your PC Card, Windows 95 should display the New Hardware Found dialog box, prompting you to set up your PC Card. Follow the instructions on the screen to set up your PC Card.

If Windows 95 doesn't detect your card automatically, follow these steps:

- 1 Click the My Computer icon with the secondary button.**
- 2 Click Properties on the shortcut menu that appears.**

Windows 95 opens the System Properties dialog box.

- 3 Click the Device Manager tab to access the Device Manager page.**

The Device Manager page should list a PCMCIA socket. If it doesn't, return to the Control Panel, double-click the Add New Hardware icon and follow the instructions on the screen to add a PCMCIA socket controller.

**4 Click the “+” to the left of the PCMCIA Socket icon in Device Manager.**

Device Manager lists the controller(s).

**5 The controller icon(s) will appear in one of the following ways:**

- ❖ If the icon appears normally, PC Card support is set up correctly. Close the System Properties dialog box and Control Panel.
- ❖ If there is a red X over the icon, you need to set up the PC Card drivers. Continue with the remainder of this section.
- ❖ If there is a yellow exclamation point (!) over the icon, you need to configure the PC Card drivers. Continue with the remainder of this section.

**6 Click OK to close the System Properties dialog box and return to the Control Panel.****7 Double-click the PC Card (PCMCIA) icon.**

Windows 95 opens the PCMCIA Wizard.

**8 Follow the instructions on the screen to set up PC Card support.**

## Removing a PC Card

To remove a PC Card, follow these steps:



- 1 Click the PC Card button on the taskbar.**
- 2 Click Stop xxxx, where xxxx is the identifier for your PC Card.**

Windows 95 displays a message that you may safely remove the card.

- 3 If it's closed, open the PC Card slot cover on the right side of the computer.**

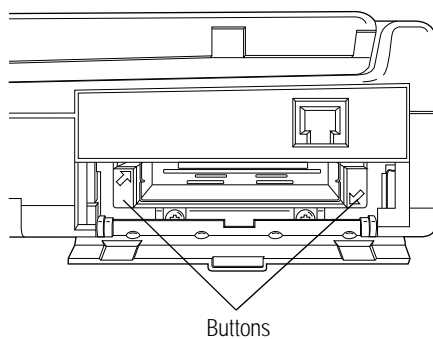

*The PC Card release buttons*

- 4 Push the button that corresponds to the slot in which your PC Card is installed.**

The left button releases a card in the upper slot. The right button releases a card in the lower slot.

- 5 Grasp the edges of the PC Card and slide it out of the slot.**
- 6 Close the PC Card slot cover.**

# Connecting to the World

---

On its own, your Tecra 740CDT computer is an extremely powerful tool. However, not until you connect it to one or more additional computers, through a modem, network or cellular connection, can you begin to recognize its full potential.

By using Windows 95's Dial-Up Networking feature and your modem, you can communicate with your office's local-area network (LAN), a larger corporate wide-area network (WAN) or the Internet. For specific information about connecting to a LAN or WAN, consult your network administrator.

This chapter explains how to use your computer's built-in data/fax modem and to fax a document directly from your computer. It describes the many ways you can use your modem to connect to other computers and services, such as the Internet.

## If You're Ready to Go

This section provides a brief overview of the steps contained in the remainder of the chapter. If you're an experienced computer user, this may be enough for you. If you need more help, each step tells you where to go for more information. Follow these steps:

### 1 Determine the COM port the fax/modem is using.

You'll need to know this to set up your communications program. If you're using a communications program designed for Windows 95, your program may determine the COM port automatically. For more information, see "Determining the COM Port" on page 207.

### 2 Install the communications program.

This may be a general-purpose communications program or one supplied by a specific service provider. For more information, see "Choosing the Communications Program" on page 208.

### 3 Sign up.

If you're planning to use an on-line service or the Internet, you'll need to register with a service provider. For more information, see "Logging On to an On-line Service or the Internet" on page 219.

## Setting Up

To communicate with the outside world you'll need:

- ❖ A modem (you already have this installed in your computer).
- ❖ A telephone line.
- ❖ A communications program (see "What Software Do You Need?" on page 215 if you're planning on using an on-line service or the Internet, or "Connecting Directly to Another Computer" on page 225 for information about general communications programs).

- ❖ If you're planning on using the Internet, you'll need an access provider (see "Exploring the World of the Internet" on page 212).

## Determining the COM Port

Your modem is connected to one of the computer's COM (communications) ports. The default setting is COM2.



*Although the terms are often used interchangeably, the serial port and COM port are really two different things. The serial port is the physical port on the left side of the computer. The COM port is a unique identifier the computer uses to communicate with the serial port or other serial devices.*

If you're using a Windows 95 communications program, such as Hyperterminal, it determines the COM port automatically. Skip to the following section.

If you are going to install and set up a non-Windows 95 communications program, you must tell it which COM port your modem is using.

To find out which port your modem is connected to, follow these steps:

**1 Click Start, then point to Settings.**

**2 Click Control Panel.**

Windows 95 opens the Control Panel.

**3 Double-click Modems.**

Windows 95 displays the Modem Properties dialog box.

**4 Click the Diagnostics tab.**

Your modem should be listed next to one of the computer's COM ports.

**5 Make a note of the COM port number.**

- 6 To verify that the modem is set up properly, click the port to which your modem is connected and then click More Info to run the Windows 95 Modem Diagnostics.**

Windows 95 communicates with the modem and displays identifying information reported by the modem. If Windows 95 can't communicate with the modem, it displays an error message. Consult the troubleshooting sections of your modem and Windows 95 documentation.

- 7 Click OK to close the Modem Properties dialog box.**
- 8 Close the Control Panel.**

## Choosing the Communications Program

The communications program you use depends on what you're planning to do. For example, to access the Internet, you'll need some form of Internet access program. To transfer files from your office network, you'll need a remote access program.

To log on to an on-line service or the Internet, see "What Software Do You Need?" on page 215. General-purpose programs are discussed in "Connecting Directly to Another Computer" on page 225.

## Connecting to a Telephone Line

You need to connect the modem to a voice-grade telephone line. Normally you do this using a telephone cable and a standard modular phone jack. As the business world becomes more accustomed to busy executives and their portable computing needs, phone jacks are becoming available in more locations. For example, many hotels that cater to business travelers have one or more phone jacks in each room.



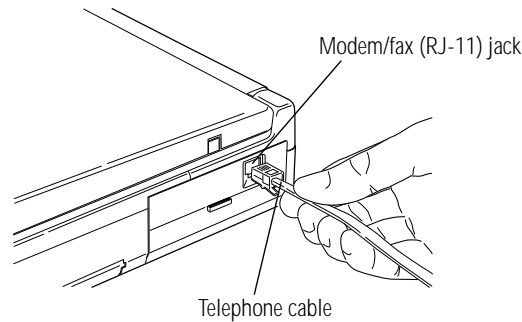

*Connecting the telephone cable to the modem/fax jack*

Plug one end of the **telephone cable** into the **modem/fax jack** on the right side of the computer and the other end into the wall jack.



*If you are using the telephone line at home, disable call waiting before you connect through the modem. Call waiting interrupts transmission.*

Now that you're set up it's time to communicate. You're ready to send a fax (see "Faxing a Document" on page 210) or use the modem to connect to the exciting virtual world of the Internet or an on-line service (see "The Internet and Other Fascinating Places" on page 211).

## Connecting to a Cellular Telephone Line

The internal modem that comes with your Tecra 740CDT computer is not equipped to use a cellular telephone line, but you can purchase an upgraded cellular-compatible modem from Toshiba or your computer dealer.

To install the cellular modem, follow these steps:

- 1 Unsnap the face plate that covers your built-in modem.**
- 2 Remove the two screws that hold the modem in place.**

**3 Slide the modem out of the computer.**

---



*If you have trouble removing the modem, plug a telephone cable into the modem's RJ-11 jack, then pull the cable gently to slide the modem out of the slot.*

---

**4 Insert the cellular modem into the slot.**

**5 Replace the two screws you removed in step 3.**

With a cellular modem, you can use any cellular line. Be sure to remain stationary while transmitting data over a cellular phone, as transmitting data while you are moving causes problems when the cellular network hands off the call to the next cell.

## Faxing a Document

Sending a fax through your computer's built-in data/fax modem is almost as simple as printing a document. Two fax programs, Multimedia Connect Fax and Microsoft Fax, are included with your computer.

Windows 95 treats your fax program as if it is another printer. To send a fax:

- 1 Choose Print Setup from within the program you're using to prepare your document.**
- 2 Select your fax printer driver from the list of available printers.**

To use Microsoft Fax, set the printer to Microsoft Fax. For more information, refer to the Microsoft Fax on-line Help program.

**3 Click OK.**

If you're using Microsoft Fax, it prompts you for a telephone number and gives you the opportunity to attach a standard cover sheet.

Other fax programs will operate in much the same way. If you're using a different fax program, refer to the program's documentation for more information.

**4 Click Finish to send the fax.**

## Using the Computer's Telephony Features

Your computer comes with Multimedia Connect, a communications program that lets you use the computer's built-in modem to:

- ❖ Place and receive telephone calls
- ❖ Set up and use a voice mail system
- ❖ Send faxes directly from your word-processing or spreadsheet program

For detailed information about this program, refer to the Multimedia Connect documentation provided with your computer.

## The Internet and Other Fascinating Places

If you've never used a modem before, you may not be aware of the vast array of possibilities that await you. You can:

- ❖ Subscribe to an on-line service.
- ❖ Explore the vastness of the Internet.
- ❖ Log on to an electronic Bulletin Board Service (BBS).
- ❖ Communicate directly with another computer, such as one owned by a friend or one in your office.

The following sections describe each of these options and provide a brief overview of how to access them.

## On-line Services

On-line services, such as America Online (AOL) and CompuServe, provide easy access to home shopping, travel arrangements, stock quotes, and forums on a wide variety of topics. You can send electronic mail (e-mail) to other subscribers, ask questions on almost any subject, and access a variety of reference materials. Information on most of these services is available through an easy-to-use user interface. Most on-line services also provide full access to the Internet. Information about the Internet is contained in the following section.

## Exploring the World of the Internet

---



*This section contains only a brief overview of the Internet. For more information, look through the books on the Internet that are available at your local book or computer store.*

---

The Internet is a network of computer networks located all around the world. Information available on the Internet is actually contained on one or more of the member networks. The Internet's origins trace back to the ARPANET, a system created by the U.S. Defense Department. The National Science Foundation (NSF) greatly expanded the system, providing researchers at various sites, such as universities, access to one large body of information.

An on-line service, such as CompuServe or AOL, is operated by a governing corporate body. The Internet, on the other hand, is much more random. No governing body controls who may access its resources or what information may be published on it. Every user is free to contribute and participate without restriction. As more users log on, contributing their own personal styles, the Internet continues to change. The open, international nature of the Internet makes it impossible to regulate or control effectively.

Here are some of the things you can do on the Internet:

- ❖ Search for information on any topic.
- ❖ Send and receive electronic mail (e-mail).
- ❖ Join a written conversation in progress with one or more other people.
- ❖ Shop and do your banking.
- ❖ Get computer programs and other information files.
- ❖ Listen to the radio.
- ❖ Play games with people from around the world.
- ❖ Watch live concerts and interviews.
- ❖ Publish your own articles, books and multimedia works.

### **On-line Service vs. Internet Service Provider**

Deciding which option is best for you may not be easy. Fortunately, you can always change your mind. When making a decision, consider the following:

- ❖ On-line services combine an easy-to-use interface and a wide range of useful services with full Internet access. Each on-line service has a different flavor. Look at advertising material for more than one service to see what each provides. Then decide which service seems most suitable for you.
- ❖ If you don't need the special services offered by an on-line service, logging on to the Internet via an Internet Service Provider (ISP) may be best for you. Because of the enormous size and number of options on the Internet, it can be more difficult to find your way around. If possible, ask a knowledgeable friend to help you.

Some service providers, such as NetCom and Pipeline, provide service to a large area. Others may serve an area as small as a single county. To find out about Internet service providers in your area, check with your computer store, look in computer magazines and local newspapers or ask a friend who's already connected.

### What Will it Cost?

---



*When you call to sign up to an on-line service or Internet access provider, make sure you have a credit card handy. Even if your service offers an initial free period, your credit card will be billed for use beyond that time.*

---

When you sign up with an Internet service provider or on-line service, make sure you understand the costs involved. Most services charge a monthly rate for a certain number of hours or for unlimited use. An hourly rate applies to additional time on line. If you don't have a local telephone access number, long distance call charges also apply.

Some services charge by the hour. If your service charges by the hour, make sure you know how long you've been on line. It's easy to lose track of time and run up the costs when you're exploring the Internet or an on-line service.

Some services offer both flat and hourly rates.

## What Software Do You Need?

To subscribe to an on-line service or log on to the Internet directly, you need a suitable communications program.

- ❖ If you're subscribing to an on-line service or an Internet service provider, you need the startup kit for the service. The startup kit includes everything you need to set up your account along with the program you use to access the service. It may be supplied free, as an inducement to use that service, or you may need to buy it.
- ❖ If you're using a local Internet service provider, the provider will likely offer or recommend a software package for accessing the Internet.

## Types of Internet Sites

Each network that belongs to the Internet is a "site" on the Internet. There are different types of Internet sites:

- ❖ A World Wide Web (WWW) site is a place where people can publish their own home pages. Each page has a unique address, in the form of a Universal Resource Locator (URL). You can locate a specific home page by entering its URL or you can click on a hypertext link—indicated by a different color of text or some other obvious means—and jump to the connecting page.
- ❖ Mail servers store and forward electronic mail (e-mail). In many ways, e-mail is like regular mail, but it can be much faster and more convenient.
- ❖ FTP sites store computer files. You can download files from an FTP site. For example, many computer companies distribute minor upgrades to their programs through FTP sites.



---

*When you download a file, you transfer the file from another computer (or an FTP site) to your computer.*

---

- ❖ Usenet sites maintain newsgroups, which are lists of messages dedicated to a particular topic. Subscribers to a newsgroup can read and respond to messages posted by others, and post messages of their own.
- ❖ LISTSERV sites administer mailing lists, which are lists of people who are interested in the same topics. Individuals send their message to the centralized LISTSERV site. The LISTSERV server “broadcasts” the message to all the members of the mailing list. This way one person can correspond with lots of people all at once. Mailing lists are different from newsgroups in that you receive all messages automatically.
- ❖ Chat sites allow people to “talk” in real time. Whereas you send your written message to a newsgroup to be read later, in a chat session you type your message and other people in the virtual chat session can respond immediately.
- ❖ Gopher sites provide lists of what is available elsewhere on the Internet. Searching a gopher site is a good way to look for specific information.
- ❖ Telnet sites let you log on to a computer somewhere else in the world and use its resources as if it were on your own local network.

## Understanding Internet Addresses

Every Internet user and site has an address. The first type of address is the individual address, used for e-mail. A sample e-mail address is:

*user@host.subdomain.domain*

where:

*user* is the name you select when you first subscribe to your on-line service or Internet access provider. See “What Software Do You Need?” on page 215 for information about Internet access providers.



---

<i>host</i>	is the computer on which your Internet account is located.
<i>subdomain</i>	is a local network or computer within the host's system. Many addresses do not include a subdomain.
<i>domain</i>	indicates the type of host. In the United States, there are six domains: com for commercial hosts gov for governmental institutions edu for educational institutions mil for military organizations net for network and service companies org for other organizations

The second type of address is the Universal Resource Locator (URL), used to locate specific sites on the Internet. A sample URL is:

`http://aaa.bbb.ccc/dir1/dir2/dir3`

where:

<code>http://</code>	is the resource type, indicating that the site is designed in hypertext markup language. HTTP stands for Hypertext Transfer Protocol and indicates a site on the WWW. Other resource types you might see in a URL included Gopher, FTP and Telnet.
<code>aaa.bbb.ccc/</code>	is the address of the actual computer where the information is stored.
<code>dir1/dir2/dir3</code>	is the folder (directory on the host computer) in which the information is located.

## Etiquette On Line

When you use the Internet, it's important to remember that you're dealing with people. You should give other people and "local" customs the same respect on line as you would face-to-face.

Keep the following points in mind:

- ❖ If you're unsure about what might or might not be proper behavior, most newsgroups have a list of FAQs (Frequently Asked Questions). There's also a list of general Internet FAQs on the news.announce.newusers newsgroup.
- ❖ If you're still unsure, read the offerings from others before you post something of your own (this is called "lurking"). This way you can get a feel for what's going on without letting anybody know you're there or making a social blunder.
- ❖ Whenever you post something on the Internet, include your name and e-mail address. It's a common courtesy to let others know who they're dealing with, and gives them a chance to respond.
- ❖ Be considerate. Just as nobody likes being insulted face-to-face, it's no fun on line either. This isn't to say you can't disagree with anybody on the Internet. A wide variety of differing viewpoints is one of the things that keeps the Internet so vital and alive.

---

## Logging On to an On-line Service or the Internet

This section gives some tips for logging on to an on-line service or the Internet. The basic steps you need to take are as follows:

- ❖ Set up an account with an Internet Service Provider (ISP) or on-line service and obtain your user name and password (for more information see “Installing TCP/IP Networking” on page 220).

Request PPP (Point-to-Point Protocol) service, as it is faster and more secure than SLIP (Serial Line Internet Protocol).



*If you are connecting to a Local Area Network (LAN) or Wide Area Network (WAN) that has direct Internet access, you may have remote access to the Internet through your network. Ask your network administrator.*

---

- ❖ Install, configure and verify your modem.
- ❖ Add Microsoft’s TCP/IP (Transmission Control Protocol/Internet Protocol) networking protocol to your computer (for more information see “Installing TCP/IP Networking” on page 220).
- ❖ Install Dial-Up Networking and setup your Internet connection (for more information see “Installing Dial-Up Networking” on page 221).

## Installing TCP/IP Networking

To set up Microsoft's TCP/IP networking protocol, follow these steps:

**1 Click Start, then point to Settings.**

**2 Click Control Panel.**

Windows 95 opens the Control Panel.

**3 Double-click Network.**

Windows 95 displays the Network dialog box.

**4 Click Add.**

**5 Select Protocol and click Add.**

The system displays the Select Network Protocol dialog box.

**6 Under Manufacturers, select Microsoft.**

**7 Under Network Protocols, select TCP/IP and click OK.**

Windows installs TCP/IP on your computer.

**8 Restart Windows to activate the TCP/IP protocol.**

**9 To verify that TCP/IP is properly connected to the Windows 95's Dial-Up feature, highlight Dial-Up Adapter on the Configuration page of the Network dialog box, then click Properties.**

To access the Network dialog box, repeat steps 1 through 3.

Windows 95 displays the Dial-Up Adapter Properties dialog box.

**10 Click the Bindings tab and deselect all protocols except TCP/IP.**

**11 Click OK twice to exit the Network menu.**

## Installing Dial-Up Networking

To install Dial-Up Networking, follow these steps:

**1 Click Start, then point to Settings.**

**2 Click Control Panel.**

Windows 95 displays the Control Panel.

**3 Double-click Add/Remove Programs.**

Windows 95 displays the Add/Remove Programs Properties dialog box.

**4 Click the Windows Setup tab.**

**5 Select Communications and click Details.**

**6 Select Dial-Up Networking and click OK.**

**7 Click OK to continue.**

Windows 95 adds Dial-Up Networking to your system.

**8 Click OK to finish and then close the Control Panel.**

**9 Restart your computer.**

Dial-Up Networking is ready to use. If you have not already installed TCP/IP, do so before restarting the computer.

## Setting Up Your Internet Connection

To set up your Internet connection, follow these steps:

**1 To verify that the computer and modem are connected, click Start and point to Settings.**

**2 Click Control Panel.**

Windows 95 opens the Control Panel.

**3 Double-click Modems.**

Windows 95 displays the Modems Properties dialog box.

**4 Click the Diagnostics tab, then click More Info.**

Windows 95 should display the name and model of your modem. If it does not display the correct information, you may have to reinstall your modem.

**5 Click OK twice to exit modem diagnostics.****6 Close the Control Panel.****7 Click Start and point to Programs.****8 Point to Accessories, then click Dial-Up Networking.**

The system opens the Dial-Up Networking Wizard.

**9 Click Next to begin the setup.****10 Type a name to identify the location you are calling.**

For example, "My Office" if you are calling your office's local area network (LAN) or "XXX" where XXX is the name of your Internet service provider.

Your modem should be listed under Select a Modem.

**11 Click Next to continue.****12 Type the telephone number of the network you are calling, including the area code and click Next.**

Select the appropriate country code if you are dialing an international number. You can set up additional Dial-Up Networking locations after you have completed the setup for the first location.

**13 Click Finish to add the connection to your Dial-Up Networking folder.****14 To set specific connection options, click the connection in the Dial-Up Networking folder with the secondary button, then click Properties on the shortcut menu that appears.**

Clear "Use country code and area code for local calls."

**15 Click Server type to select network-specific options.**

Network options include logon options and protocols. Ask your network administrator or Internet service provider (ISP) for the correct option settings.

**16 Click OK twice to exit and then close the Dial-Up Networking folder.**

## Some Interesting Places to Start

If you're new to the Internet and don't know where to start, this section gives you a few sites you might find interesting.



*The Internet is constantly changing. It's possible that one or more of these sites have changed addresses or disappeared altogether.*

## WWW Sites

- ❖ Toshiba's homepages are:
  - <http://www.toshiba.com> (worldwide Toshiba corporate site)
  - <http://computers.toshiba.com> (marketing and product information in the USA)
  - <http://pcsupport.tais.com> (Product Support in the USA)
  - <http://www.toshiba.ca> (Canada)
  - <http://www.toshiba-tice.com> (Toshiba Europe)
  - <http://www.toshiba.co.jp/> (Japan)
- ❖ <http://river.ihs.gov/> has some great information and pictures about Grand Canyon river running.
- ❖ <http://snow.water.ca.gov/> gives information about the California snow pack.
- ❖ <http://www.irs.ustreas.gov/prod/cover.html> is the site operated by the U.S. Internal Revenue Service.

- ❖ <http://nwsfo.atmos.albany.edu> provides weather-related information.
- ❖ <http://www.epicurious.com/> presents a delicious array of recipes and information on food and drink.

### A Few Newsgroups

- ❖ [alt.comedy.british](mailto:alt.comedy.british) is for fans of British humour.
- ❖ [alt.sports.badminton](mailto:alt.sports.badminton) lets you keep current with information about badminton.
- ❖ [news.newusers.questions](mailto:news.newusers.questions) is dedicated to information for new users of the Internet.
- ❖ [rec.backcountry](mailto:rec.backcountry) contains information about outdoor activities, such as backpacking and camping.
- ❖ [sci.anthropology](mailto:sci.anthropology) provides discussions on anthropology.

### Search Engines

- ❖ <http://www.yahoo.com/>
- ❖ <http://www.webcrawler.com/>
- ❖ <http://www.altavista.digital.com/>
- ❖ <http://www.albany.net/allinone/>

### Additional Places of Interest

- ❖ [president@whitehouse.gov](mailto:president@whitehouse.gov) is the e-mail address of the U.S. President.
- ❖ [marvel.loc.gov](mailto:marvel.loc.gov) is the gopher for the Library of Congress.



---

## Connecting Directly to Another Computer

If you're connecting directly to another computer or a bulletin board system (BBS), you'll need a general-purpose communications program, such as the Hyperterminal program included with Windows 95. This section describes some of the things you'll need to know to connect to another computer, but does not contain specific instructions for any communications programs. Refer to Hyperterminal's Help for information about using Hyperterminal.

There are two things you need to know before you can connect to another computer:

- ❖ The communications parameters
- ❖ The file transfer protocol (only if you're downloading or uploading files)

The following sections explain what these mean.

### Communications Parameters

There are four communications parameters:

- ❖ Modem speed is the speed at which the modem transfers information. Speeds are measured in bits per second. Your modem manual documents the speed of your modem.
- ❖ Data bits is the number of bits in one character. This number is usually seven or eight.
- ❖ Stop bits indicate the end of a character. This number is usually one or two.
- ❖ Parity is an error-checking method and will be set to even, odd or none.

These parameters, except for the modem speed, are usually abbreviated and combined. Common examples are N81 (no parity, eight data bits and one stop bit) and E72 (even parity, seven data bits and 2 stop bits).

You set each of these parameters in your communications program. Each parameter must be set the same on both computers or you won't be able to connect.

## File Transfer Protocols

File transfer protocols are standards that govern how computers transfer files between modems over a telephone line. Protocols determine what type of error checking and data compression, if any, occur during transfer. Based on a number of factors, some protocols are faster than others. Popular protocols include XMODEM (one of the earliest and still one of the most reliable protocols) and ZMODEM (about the fastest available these days).

You don't really need to know anything about specific protocols—just make sure you're using the same as the computer with which you're communicating. If you would like to know more, protocols are described in any book on telecommunications, available at your local book or computer store.

## Using Bulletin Board Services

Local electronic bulletin board services (BBSs), like their mundane counterpart hanging on your wall, let you post messages for friends, or questions to which a wide variety of people can respond. Many BBSs also offer software (programs) or shareware that you can copy to your computer (called downloading).



*Shareware programs are copyrighted programs that you can try out for free. If you decide you like the program, you must send in a small registration fee. Upon registering some shareware programs, you may receive additional benefits, such as a printed manual or free future upgrades.*

---

Most BBSs serve a particular interest group and are run by an individual or small group of people. For example, a science fiction BBS may have messages from people looking for out-of-print books and offer a few sample sections of new works.

Most computer companies offer a BBS as one way to provide customers with software updates and answers to their questions. Toshiba's 24-hour BBS offers Toshiba computing information and is a good source of Toshiba utilities files and technical bulletins. Complete information about accessing Toshiba's BBS is found in "Toshiba's Bulletin Board Service" on page 340.

To access a BBS, you'll need an all-purpose communications program, such as Hyperterminal, provided with Windows 95. See the following section for information about using all-purpose communications programs.

## Discovering Toshiba's On-line Resources

In addition to the Toshiba Internet sites listed under "WWW Sites" on page 223, Toshiba maintains a number of on-line sites to which you can connect. These sites can provide information about Toshiba products, help with technical questions and keep you up to date with future upgrades.

- ❖ On CompuServe, type go toshiba
- ❖ To access Toshiba's BBS, set your modem to N81 and call either 714-837-4408

## Controller Mode vs. Controller-less Mode

This section provides information about operating the modem in controller-less vs. controller mode, and explains how to set up your communications program to work with the computer's built-in modem.

## Two Modes of Operation

When you set up Windows 95 or Windows for Workgroups on your computer, the computer's built-in modem is set to controller-less mode automatically. This mode provides access to your computer's telephony features, in addition to data and fax transmission. The telephony features let you use your computer to:

- ❖ Place and receive phone calls.
- ❖ Set up and use a voice mail system.

Controller-less mode is compatible with Windows 95 and Windows for Workgroups. If you're using an operating system that doesn't currently support controller-less mode, such as MS-DOS, OS/2, or Windows NT, the modem operates in controller mode. In this mode, you can use the modem for data and fax transmission, but you won't be able to use the computer's telephony features.

You may also need to switch from controller-less mode to controller mode if your communications program needs to access the modem hardware directly.

## Changing Modes in Windows 95

This section provides instructions for changing to controller mode or controller-less mode in Windows 95. To change modes in Windows for Workgroups, refer to "Changing Modes in Windows for Workgroups" on page 231.



NOTE

*These instructions assume the modem is still configured to the default setting (COM2).*

---

---

## Selecting Controller Mode in Windows 95

To select controller mode, follow these steps:



CAUTION

*While in controller mode, you won't be able to use your computer's telephony features.*

---

**1 In Windows 95, click the My Computer icon with the secondary button.**

**2 Click Properties.**

Windows 95 displays the System Properties dialog box.

**3 Click the Device Manager tab.**

**4 Click Toshiba Modem Port (COM2).**

If you don't see this option, click the "+" next to Ports (COM & LPT), then click Toshiba Modem Port (COM2).

**5 Click Properties.**

Windows 95 displays the Toshiba Modem Port (COM2) Properties dialog box.

**6 Click the Driver tab.**

**7 Click Change Driver.**

Windows 95 displays the Select Device dialog box.

**8 Click Communications Port, then click OK.**

**9 Click OK to accept the new drivers.**

**10 Click Yes to restart the computer.**

The computer restarts. The modem is now in controller mode.

- 11 To verify that the built-in modem is using the correct port, click the My Computer icon with the secondary button, then click Properties.**

Windows 95 displays the System Properties dialog box.

- 12 Click the Device Manager tab.**

- 13 Click the “+” next to Modem.**

- 14 Click TOSHIBA Internal Modem, then click Properties.**

Windows 95 displays the Modem Properties dialog box.

- 15 Click the Modem tab.**

- 16 Confirm that the port is set to Communications Port (COM2). If not, change to Communications Port (COM2) and click OK.**

## Selecting Controller-less Mode in Windows 95

To select controller-less mode, follow these steps:

- 1 In Windows 95, click the My Computer icon with the secondary button.**

- 2 Click Properties.**

Windows 95 displays the System Properties dialog box.

- 3 Click the Device Manager tab.**

- 4 Click the “+” next to Ports (COM & LPT), then click Communications Port (COM2).**

- 5 Click Properties.**

Windows 95 displays the Communications Port (COM2) Properties dialog box.

- 6 Click the Driver tab.**

**7 Click Change Driver.**

Windows 95 displays the Select Device dialog box.

**8 Click Toshiba Modem Port, then click OK.**

**9 Click OK to accept the new drivers.**

**10 Click Yes to restart the computer.**

The computer restarts. The modem is now in controller-less mode.

**11 To verify that the built-in modem is using the correct port, click the My Computer icon with the secondary button, then click Properties.**

Windows 95 displays the System Properties dialog box.

**12 Click the Device Manager tab.**

**13 Click the “+” next to Modem.**

**14 Click TOSHIBA Internal Modem, then click Properties.**

Windows 95 displays the Modem Properties dialog box.

**15 Click the Modem tab.**

**16 Confirm that the port is set to Toshiba Modem Port (COM2). If not, change to Toshiba Modem Port (COM2) and click OK.**

## Changing Modes in Windows for Workgroups

This section provides instructions for changing to controller mode or controller-less mode in Windows for Workgroups.



NOTE

*These instructions assume the modem is still configured to the default setting (COM2).*

## Selecting Controller Mode in Windows for Workgroups

To select controller mode, follow these steps:



*While in controller mode, you won't be able to use your computer's telephony features.*

- 1 Exit Windows for Workgroups.**
- 2 At the system prompt, type `cd c:\windows` and press Enter.**
- 3 Type `edit system.ini` and press Enter.**  
Edit opens the SYSTEM.INI file.
- 4 Press Alt + S, then type F.**
- 5 In the Find What: field, type `attmodem.vxd` and press Enter.**  
Edit searches for the selected text.
- 6 Put a semi-colon (;) in front of the line `device=attmodem.vxd`, so it appears as follows:**  

```
;device=attmodem.vxd
```
- 7 Press Alt + S, then type F.**
- 8 In the Find What: field, type `attwave.driv` and press Enter.**  
Edit searches for the selected text.
- 9 Put a semi-colon (;) in front of the lines `wave1=attwave.driv` and `aux1=attwave.driv`, so they appear as follows:**  

```
;wave1=attwave.driv and  
;aux1=attwave.driv
```
- 10 To save your SYSTEM.INI file, press Alt + F, then type S.**
- 11 Press Alt + X to exit Edit.**
- 12 Start Windows for Workgroups.**  
The modem is now in controller mode.



## Selecting Controller-less Mode in Windows for Workgroups

To select controller-less mode, follow these steps:

- 1 Exit Windows for Workgroups.**
- 2 At the system prompt, type `cd c:\windows` and press Enter.**
- 3 Type `edit system.ini` and press Enter.**  
Edit opens the SYSTEM.INI file.
- 4 Press Alt + S, then type F.**
- 5 In the Find What: field, type `attmodem.vxd` and press Enter.**  
Edit searches for the selected text.
- 6 Remove the semi-colon (;) from the front of the line `;device=attmodem.vxd`, so it appears as follows:**  
`device=attmodem.vxd`
- 7 Press Alt + S, then type F.**
- 8 In the Find What: field, type `attwave.driv` and press Enter.**  
Edit searches for the selected text.
- 9 Remove the semi-colon (;) from the front of the lines `;wave1=attwave.driv` and `;aux1=attwave.driv`, so they appear as follows:**  
`wave1=attwave.driv and`  
`aux1=attwave.driv`
- 10 To save your SYSTEM.INI file, press Alt + F, then type S.**
- 11 Press Alt + X to exit Edit.**
- 12 Start Windows for Workgroups.**  
The modem is now in controller-less mode.

## Setting Up Your Communications Program

Your computer comes with Multimedia Connect, a communications program that allows you to transmit data and fax, in addition to providing access to your computer's telephony features. If you wish to use a different communications program, you'll need to set up the program to work with the built-in modem. Choose one of the following from the program's list of supported modems:

- ❖ TOSHIBA Tecra 740CDT internal modem
- ❖ AT&T modem (generic)

If you do not see either of the above choices on the list of supported modems, you'll need to add the built-in modem to the list or modify an existing list item, specifying the following modem initialization string:

```
&F &C1 &D2 V1 /V1
```

Refer to your communications program's documentation for information on setting up a modem and entering a modem initialization string.



# Using Your Computer on Your Desk

---

Your Tecra 740CDT computer was designed to be easy to carry around and use while you travel. However, it's also powerful enough to use as your primary desktop computer.

This chapter describes how to connect several optional devices that can make your computer at home on your desk.

## Using an External Monitor

You can easily attach an external monitor to your computer. Some external monitors display more information than the computer's built-in LCD. Also, having an external monitor makes the entire display bigger.

## Connecting an External Monitor

To connect an external monitor, follow these steps:

**1 Turn the computer off.**

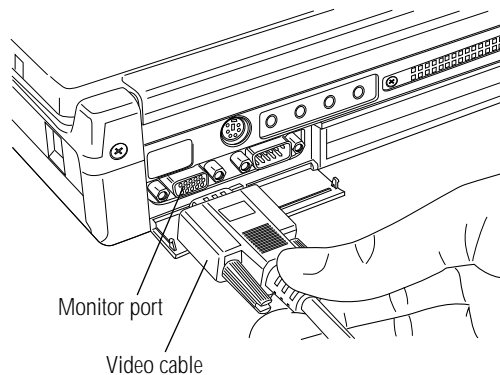

*Connecting an external monitor*

**2 Connect the monitor's video cable to the monitor port on the back of the computer.**

**3 Turn the external monitor on.**

**4 Turn the computer on.**

The computer uses the external monitor.

## Directing the Display When You Turn the Computer On

When you turn the computer on, it sends information to the external monitor. To send information to the built-in LCD as well, you'll need to change the Power On Display option setting in TSETUP, or use the display hotkey, Fn + F5.

The Power On Display option in TSETUP has two settings:

- ❖ Internal/External sends the display to the external monitor. If no external monitor is attached, it sends information to the computer's built-in LCD. This is the default setting.
- ❖ Simultaneous sends display output to both the external monitor and the built-in LCD. This is especially useful if you're making a presentation and wish to guide the discussion from your computer.



*Simultaneous mode won't work if your external monitor can't display resolutions of 1024 x 768, or if you're using a display mode not supported by the built-in display adapter.*

This section explains how to change this option using the hotkey (Fn + F5). To change this option using TSETUP, see "TSETUP" on page 427.

To set this option using the hotkey, follow these steps:

- 1 Press** Fn + F5.
- 2 Still holding** Fn, **press** F5 **repeatedly until the setting you want takes effect.**

This hotkey cycles through the settings in the following order: built-in display only, external monitor only, and simultaneous display.

- 3 Release the** Fn **key.**

## Using an External Keyboard

If you prefer to use a standard desktop keyboard, you can attach one to your computer. The computer's PS/2 mouse/keyboard port supports any PS/2-compatible keyboard.



*You can only connect one PS/2 device at a time, unless you purchase an optional Y-cable. Connecting a Y-cable to the computer's PS/2 port allows you to connect a PS/2 mouse and a PS/2 keyboard simultaneously.*

---

## Connecting the Keyboard

To connect an external keyboard, follow these steps:

### 1 Turn the computer off.



*Make sure the computer is off before you attach the keyboard. Connecting a keyboard with the computer's power on may damage the keyboard, the computer or both.*

---

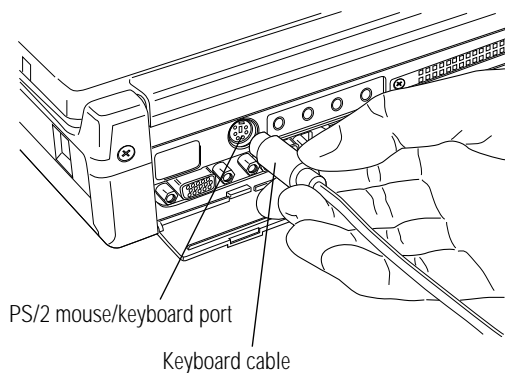

### *Connecting an external keyboard*

### 2 Attach the keyboard cable to the PS/2 mouse/keyboard port on the back of the computer.

- 3 See the keyboard's documentation for additional configuration steps.
- 4 Turn the computer on.

## Making Your External Keyboard Pretend it Has the Fn Key

An external keyboard doesn't have the Fn key contained on the Tecra 740CDT computer's built-in keyboard. If you use the computer's hotkeys or have set up key combinations in Fn-esse, you'll probably miss these features when using an external keyboard. Don't worry: you can set up an external keyboard key combination to emulate the internal keyboard's Fn key. You can set up this key combination in Fn-esse, TSETUP, or through the Windows Control Panel.

In Fn-esse, this option is called Ext Keyboard Fn Key. For more information about Fn-esse, see "Starting Programs Faster with Fn-esse" on page 292.

In TSETUP, this option is called Ext. Keyboard "Fn" Key Equivalent. To find out how to set the Fn Key Emulation option using TSETUP, see "TSETUP" on page 427.

To set this option through the Windows Control Panel, follow these steps:

- 1 Click Start, then point to Settings.
- 2 Click Control Panel.  
Windows 95 opens the Control Panel.
- 3 Double-click the Keyboard icon.  
Windows 95 displays the Keyboard Properties dialog box.
- 4 Click the Toshiba tab.
- 5 In the Fn Key Equivalent for External Keyboard section, select the desired key combination.
- 6 Click OK to close the dialog box with your setting in effect.
- 7 Close the Windows Control Panel.



## Using a Serial Mouse

You may want to use a mouse instead of the AccuPoint. You can use a serial mouse or a PS/2 mouse. See “Using a PS/2 Mouse” on page 242 if you wish to use a PS/2 mouse.

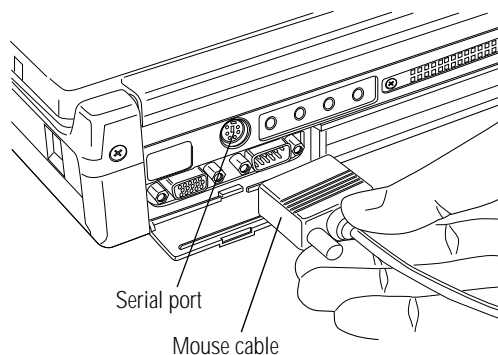

*Connecting the cable to the serial port*

To connect a serial mouse, plug the **mouse cable** into the computer's **serial port**. The AccuPoint won't work while the serial mouse is connected.

## Using a PS/2 Mouse

If you prefer to use a PS/2-compatible mouse, you can attach one to your computer. The computer's PS/2 mouse/keyboard port supports any PS/2-compatible mouse.



*You can only connect one PS/2 device at a time, unless you purchase an optional Y-cable. Connecting a Y-cable to the computer's PS/2 port allows you to connect a PS/2 mouse and a PS/2 keyboard simultaneously.*

---

## Connecting a PS/2 Mouse

To connect a PS/2 mouse, follow these steps:

### 1 Turn the computer off.



*Make sure the computer is off before you attach the mouse. Connecting a mouse with the computer's power on may damage the mouse, the computer or both.*

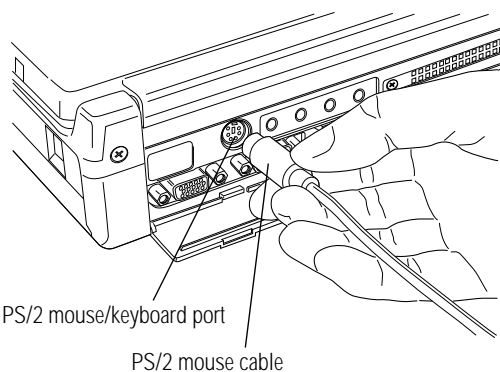

*Connecting a PS/2 mouse*

- 2 **Attach the PS/2 mouse cable to the PS/2 mouse/keyboard port on the back of the computer.**
- 3 **See your mouse documentation for additional configuration steps.**
- 4 **Turn the computer on.**

## Setting Up a PS/2 Mouse

If you connect a PS/2 mouse to the PS/2 mouse/keyboard port, you may use the mouse, the AccuPoint or both.

To set how the PS/2 mouse works with the AccuPoint, follow these steps:

**1 Click Start, then point to Settings.**

**2 Click Control Panel.**

Windows 95 opens the Control Panel.



**3 Double-click the Toshiba System icon.**

The Toshiba System Control Panel opens with the Start Up Options tab on top.

**4 Click the Miscellaneous tab.**

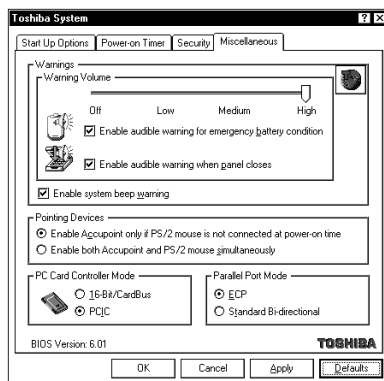

*The Miscellaneous tab of the Toshiba System Control Panel*

**5 In the Pointing Devices section of the tab, click the desired option setting:**

- ❖ “Enable AccuPoint only if PS/2 mouse is not connected at power-on time” checks for a PS/2 mouse. If one is connected, the mouse becomes active and the AccuPoint is disabled. If no PS/2 mouse is connected, the AccuPoint is active.
- ❖ “Enable both AccuPoint and PS/2 mouse simultaneously” lets you use both the AccuPoint and the PS/2 mouse.

**6 Click OK.**

The Toshiba System Control Panel displays the Toshiba System Settings Change dialog box, prompting you to restart the computer.

**7 Click Yes or No:**

- ❖ Yes restarts the computer immediately with your changes in effect.
- ❖ No allows you to save open files. After you save, restart the computer to make your changes take effect.

## The Desk Station V Plus

The Tecra 740CDT supports the optional Desk Station V Plus docking station, which provides exceptional expansion capability. By docking the computer in the Desk Station V Plus, you have immediate access to any external devices connected to the docking station (for example: printers, SCSI devices, network adapters, external keyboards, pointing devices).

Most importantly, you need to connect your peripheral devices only once. Docking and undocking your notebook to the Desk Station Plus is simple, easy and fast. You can dock the notebook

while it is on to use the devices connected to it. By pushing one button you undock the notebook to take with you.



*The back of the computer connects to the Desk Station V Plus. Therefore, if you connect your computer to a Desk Station V Plus, you won't be able to use the computer's infrared port.*

---

Windows 95 uniquely identifies each Desk Station V Plus, and creates a unique hardware profile. When you dock your computer, Windows 95 automatically determines which Desk Station the computer is connected to, and uses the correct hardware profile.

For complete information about the Desk Station V Plus, talk to your Toshiba dealer. For information about using a Desk Station V Plus, refer to the *Desk Station V Plus User's Guide*.

## Desk Station V Plus Features

The Desk Station V Plus provides the following features:













Use the SelectBay to easily install and remove a Toshiba 3 1/2-inch diskette drive module, CD-ROM drive module, or hard disk module.



Use the 5 1/4-inch expansion bay in the Desk Station V Plus to install any industry standard IDE or SCSI half-height 5 1/4-inch device (such as a hard disk, a tape drive or a CD-ROM drive).



*You cannot install two IDE devices in the Desk Station V Plus at one time. If you do so, neither device will work. This means you cannot use an IDE hard drive in the 5 1/4-inch expansion bay while a module is installed in the SelectBay. (All SelectBay modules are IDE devices.)*

---

-  Use the security lock slot to attach a Noteworthy Computer Lock cable to the Desk Station V Plus. This cable is discussed in “Viruses and How to Cure Them” on page 277.
-  Use the volume dial to adjust the loudness of the system speaker.
-  Use the two standard Type III PC Card slots to connect up to two standard PCMCIA compatible PC Cards, such as modems, network cards and ATA devices. These PC Card slots support Card-Bus PC Cards, but not Zoomed Video PC Cards.  
  
Use the two full-length expansion slots for most standard ISA and PCI expansion cards. A half-length expansion slot provides space for a PCI expansion card. You can install modem cards, hard disk drive cards, network interface cards and many others.
-  Connect a parallel printer or other parallel device through the Centronics-compatible parallel port. If you do not use this parallel port for a printer, you can connect a LAN adapter, a tape backup device, a SCSI adapter or an ECP printer.
-  The MIDI/joystick port lets you connect a joystick or a MIDI device, such as a synthesizer.
-  You can connect SCSI devices internally and externally through the 50-pin, high-density shielded SCSI II port.
-  Use the standard 9-pin, RS-232C serial port to connect a serial device, such as a serial printer, modem or mouse.
-  You can use the video port to connect an external VGA or SVGA video monitor and improve the quality of your display.
-  Use the PS/2 mouse port to connect a PS/2-compatible pointing device.
-  Use the PS/2 keyboard port to connect a PS/2 keyboard.
-  Use the microphone jack to connect an external monaural microphone or other audio input device.
-  Use the headphone jack to connect stereo headphones or externally powered stereo speakers.
-  Use the audio line-in jack to play and record stereo sound from an external audio device, such as a stereo system.

-  Use the audio line-out jack to connect your computer to a tape recorder or a stereo amplifier to record or play sounds from your computer.
-  Use the AC IN socket to connect the Desk Station V Plus to AC power, using a power cord.

## Using Optional Devices in the Desk Station V Plus

The computer supports PC Cards as add-on external devices. PC Cards are designed to meet the APM (Advanced Power Management) standard. This means they automatically go into a suspended state when you turn the computer off (with the Suspend command or with Resume Mode turned on).

The Desk Station V Plus, however, can use devices that are not APM-compliant. Suspending your system with one or more of these devices installed may result in system halts or other erratic behavior. For this reason, Suspend and Resume are not supported when the computer is docked to the DeskStation V Plus.

## Desk Station V Plus Security

“Using a Password” on page 259 describes how to set a password to protect your valuable data files. If you’re using the Desk Station V Plus and have set a password, the password can provide protection for the notebook as well.

When you enable the Undock Password option, you must enter a password before you can remove the computer from the Desk Station V Plus. This section describes how to use an undock password.

### Turning On the Undock Password

To turn on the Undock Password, follow these steps:

- 1 Click Start, then point to Settings.**
- 2 Click Control Panel.**

Windows 95 opens the Control Panel.



**3 Double-click the Toshiba System icon.**

The Toshiba System Control Panel opens with the Start Up Options tab on top.

**4 Click the Security tab to bring it to the front.**

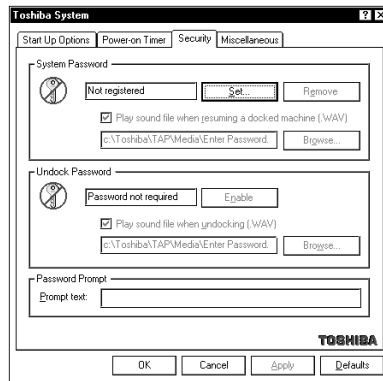

*The Security tab of the Toshiba System Control Panel*

**5 If you haven't registered a System Password, click the Set button in the System Password section of the tab.**

If you've already registered a System Password, skip to step 10.

**6 The Toshiba System Control Panel displays the Set Password dialog box.**

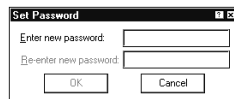

*The Set Password dialog box*

**7 Type a password of one to sixteen characters in the Enter new password box.**

You may use any combination of letters and numbers in your password.



**8 Type the password again in the Re-enter new password box.**

If the passwords match, the OK button is enabled.

**9 Click OK.**

The Toshiba System Control Panel displays the Security tab with the System Password listed as “Registered.”

**10 In the Undock Password section of the dialog box, click Enable.****11 Click OK.**

The Undock Password is registered. You’ll need to enter this password each time you remove the computer from the Desk Station V Plus.

For more information on how the password feature works, see “Using a Password” on page 259.

## The NoteDock II Enhanced Port Replicator

The expansion port allows you to connect your computer to an optional NoteDock II Enhanced Port Replicator. The NoteDock II Enhanced Port Replicator is an excellent investment if you’re using your computer both in and out of the office.

Imagine that you’re a salesperson who frequently works away from the office. When you return to your desk, you want to be able to connect to your network, print reports from your computer, and use a mouse instead of the AccuPoint. Connecting cables for each of these devices every time you return to the office is time-consuming and inconvenient.





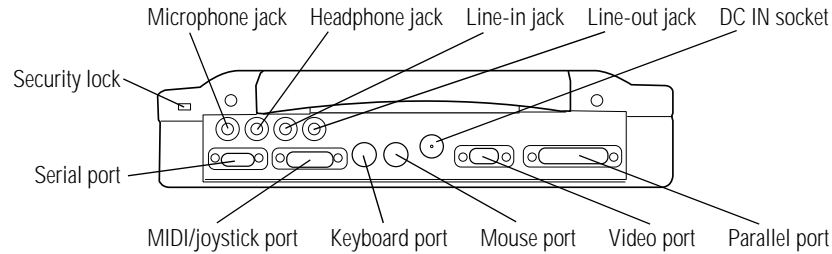

By connecting external devices to the NoteDock II Enhanced Port Replicator instead of directly to your computer, you can leave the devices connected while you are using your computer away from your desk. When you return, you can quickly connect your computer to the NoteDock II Enhanced Port Replicator and have immediate access to the devices.

## NoteDock II Enhanced Port Replicator Features

This section identifies and describes the features of the NoteDock II Enhanced Port Replicator.



*The rear of the NoteDock II Enhanced Port Replicator*

-  Use the **security lock slot** to attach a Noteworthy Computer Lock cable to the NoteDock II Enhanced Port Replicator. This cable is discussed in “Viruses and How to Cure Them” on page 277.
-  Use the **microphone jack** to connect an external monaural microphone or other audio input device.
-  Use the **headphone jack** to connect stereo headphones or externally powered stereo speakers.
-  Use the audio **line-in jack** to play and record stereo sound from an external audio device, such as a stereo system.
-  Use the audio **line-out jack** to connect your computer to a tape recorder or a stereo amplifier to record or play sounds from your computer.
-  Use the **serial port** to connect a serial device, such as a serial printer, modem or mouse.



The **MIDI/joystick port** lets you connect a joystick or a MIDI device, such as a synthesizer.



Use the **PS/2 keyboard port** to connect a PS/2 keyboard.



Use the **PS/2 mouse port** to connect a PS/2-compatible pointing device.



Use the **video port** to connect an external monitor.



Use the **parallel port** to connect a parallel printer or other parallel device.



Use the **DC IN socket** to connect the NoteDock II Enhanced Port Replicator to AC power, using the AC adapter and power cord.

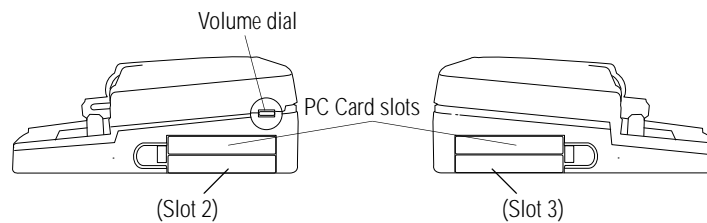

*The right and left sides of the NoteDock II Enhanced Port Replicator*



Use the two **PC Card slots** to install Type III PC Cards. The slot on the right side of the NoteDock II Enhanced Port Replicator is referred to as **Slot 2**. The slot on the left side is referred to as **Slot 3**. These slots support CardBus PC Cards, but not Zoomed Video PC Cards. For more information, see “Using PC Cards in the NoteDock II Enhanced Port Replicator” on page 255.



Use the **volume dial** to adjust the loudness of the system speaker.

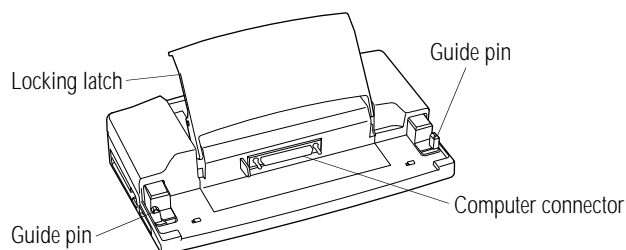

*The front of the NoteDock II Enhanced Port Replicator*

The view of the NoteDock II Enhanced Port Replicator above identifies:

- ❖ The **locking latch** that secures the computer to the NoteDock II Enhanced Port Replicator.
- ❖ The **computer connector** that connects to the expansion port on the back of your computer.
- ❖ The **guide pins** that help align the computer with the NoteDock II Enhanced Port Replicator, ensuring a proper connection.

## Connecting the Computer to the NoteDock II Enhanced Port Replicator

To attach the computer to the NoteDock II Enhanced Port Replicator, follow these steps:

- 1 Remove all cables from the back of the computer.**
- 2 Close the computer's port covers.**

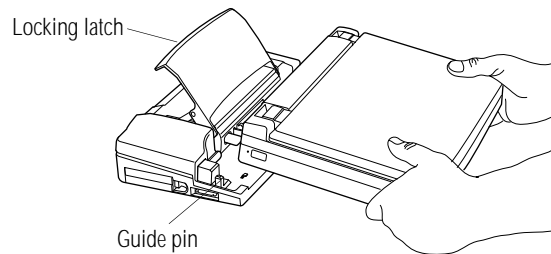

*Attaching the computer to the NoteDock II Enhanced Port Replicator*

- 3 Lift the locking latch on the NoteDock II Enhanced Port Replicator.**
  - 4 Align the two holes on the bottom of the computer with the guide pins on the NoteDock II Enhanced Port Replicator.**
  - 5 Gently press the locking latch down.**
- The computer slides into place and connects to the NoteDock II Enhanced Port Replicator.
- 6 Attach the AC adapter to the NoteDock II Enhanced Port Replicator's DC IN socket.**
  - 7 Connect the AC adapter to a wall socket.**

Windows 95 uniquely identifies each NoteDock II Enhanced Port Replicator. Every time you connect the computer to a different NoteDock II Enhanced Port Replicator, Windows 95 creates a new hardware profile. This feature is extremely useful if you have an NoteDock II Enhanced Port Replicator both at home and at the office, since Windows 95 automatically determines which port replicator the computer is connected to, and uses the correct hardware profile.

---

## Disconnecting the Computer from the NoteDock II Enhanced Port Replicator

To disconnect the computer from the NoteDock II Enhanced Port Replicator, turn the computer's power off, lift the locking latch, and remove the computer.



NOTE

*Remember to lift the back of the computer straight up, so the guide pins will not be damaged.*

---

## Using PC Cards in the NoteDock II Enhanced Port Replicator

The NoteDock II Enhanced Port Replicator provides two additional PC Card slots. These slots support CardBus PC Cards, but not Zoomed Video PC Cards.

For information about setting up PC Cards, refer to "Setting Up Your PC Card for Your Computer" on page 201.



NOTE

*In order for the NoteDock II Enhanced Port Replicator to recognize your PC Cards, you may need to run CardWorks setup.*

---

To use the PC Card slots in the NoteDock II Enhanced Port Replicator, you will need to set up PC Card support the first time you connect to the NoteDock II Enhanced Port Replicator.

To set up PC Card support, follow these steps:

- 1 Click Start, then point to Settings.**
- 2 Click Control Panel.**  
Windows 95 displays the Control Panel.
- 3 Select the PC Card (PCMCIA) icon.**
- 4 Follow the setup instructions.**

## Applying Physical Restraints

For your own peace of mind, you should secure your computer, and the DeskStation V Plus or NoteDock II Enhanced Port Replicator to a heavy object to discourage theft. You'll need a cable for each device. For example, if you have a NoteDock II Enhanced Port Replicator, you'll need one cable for the computer and another for the NoteDock II Enhanced Port Replicator.

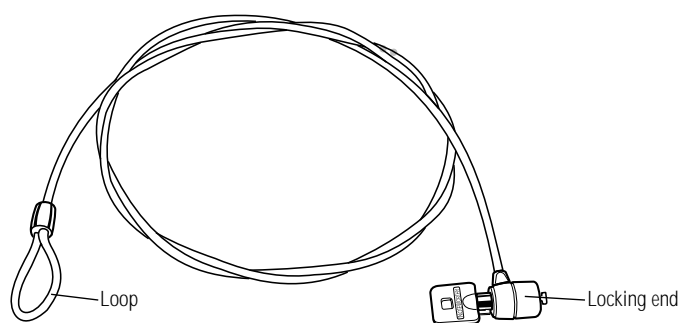

*Noteworthy Computer Lock*

To connect the optional Noteworthy Computer Lock cable, follow these steps:

- 1 Loop the cable through or around some portion of the heavy object.**
- 2 Pass the locking end through the loop.**

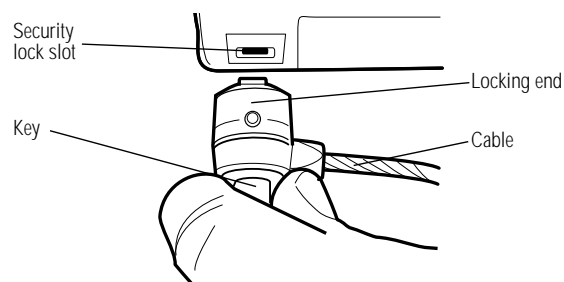

*Inserting the locking end into the security lock slot*

- 3 Insert the cable's locking end into the security lock slot on the left side of the computer.**
- 4 Turn the key a quarter turn and remove.**

The computer is securely locked. Repeat these steps for the NoteDock II Enhanced Port Replicator or DeskStation V Plus.



# Keeping Your Files Safe

---

At some time, you'll almost certainly have files on your computer that you want to keep private. Your computer comes with several options that can help you keep your computer and files safe from unwanted intrusion.

This chapter describes the security options for your notebook computer.

## Using a Password

Setting a password lets you leave your computer, secure in the knowledge that nobody can access your files. When you set a password, you must enter the password before you can work on your computer again.

Toshiba supports four types of passwords on the Tecra 740CDT computer:

- ❖ A power-on password requires you to enter the password every time you start or restart the computer.
- ❖ An instant password lets you get up and walk away from your computer for a few moments without having to turn the computer off.
- ❖ A hard disk drive password protects your data by requiring a password when you try to access the hard disk, whether it's in your computer or in another system. You can set a hard disk drive User password and/or a hard disk drive Master password.
- ❖ The undock (eject) password protects your computer and data by requiring a password when connecting to or disconnecting from the optional Desk Station V Plus.

### Creating a Password

You may create a password using either the Toshiba System Control Panel or TSETUP. This section describes how to create a password in the Toshiba System Control Panel and how to use it as an instant and power-on password. For more information about TSETUP, see “TSETUP” on page 427.



*When you register a password in the Toshiba System Control Panel, you cannot create a password service diskette. If you forget your password, you must contact Toshiba (US telephone number 800-999-4273) before you can start your computer again. To use TSETUP to register a password and create a password service diskette, follow the steps in “Protecting Against Forgetfulness” on page 262.*

---

To create (register) a password in the Toshiba System Control Panel, follow these steps:

**1 Click Start, then point to Settings.**

**2 Click Control Panel.**

Windows 95 opens the Control Panel.



**3 Double-click the Toshiba System icon.**

The Toshiba System Control Panel opens.

**4 Click the Security tab.**

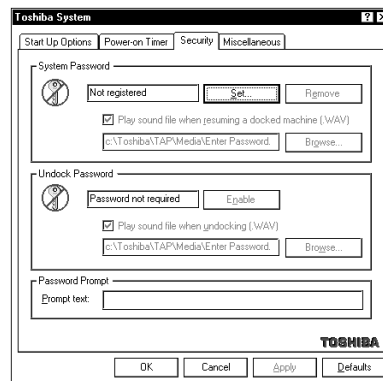

*The Security tab of the Toshiba System Control Panel*

**5 In the System Password section of the tab, click Set.**

The Toshiba System Control Panel displays the Set Password dialog box.



*The Set Password dialog box*

**6 In the “Enter new password” box, type a password of one to sixteen characters.**

You may use any combination of letters and numbers in your password.



*Make sure you use a password you can remember easily. If you ever forget your password, contact Toshiba PC Product Support (US telephone number 800-999-4273).*

*A good way to prevent forgetting your password is to create a password service diskette in TSETUP. Refer to the next section, "Protecting Against Forgetfulness" for instructions.*

---

**7 Type the password again in the "Re-enter new password" box.**

If the passwords match, the OK button is enabled.

**8 Click OK.**

The Toshiba System Control Panel displays the Security tab with the System Password listed as "Registered."

**9 If you like, you may enter a Password Prompt in the Prompt text box.**

This text appears with the password message any time you start or resume the computer.

**10 Click OK to exit the Toshiba System Control Panel.**

**11 Close the Windows Control Panel.**

## Protecting Against Forgetfulness

If you ever forget your password, a password service diskette lets you bypass the password when starting your computer. You create a password service diskette in TSETUP.



*If you forget your password and have lost your password service diskette, contact Toshiba service (US telephone number 800-999-4273).*

---

To create a password in TSETUP and create a password service diskette, follow these steps:

**1 Insert a diskette into the diskette drive.**



*Run TSETUP outside of Windows 95, at a system prompt. If you try to run TSETUP from an MS-DOS session under Windows 95, results can be unpredictable.*

**2 Click Start, then click Shut Down.**

Windows 95 displays the Shut Down Windows dialog box.

**3 Select “Restart the computer in MS-DOS mode,” then click Yes.**

Windows 95 shuts down the computer, then restarts it in MS-DOS mode and displays a system prompt.

**4 Type c:\dos\tsetup.**

TSETUP displays a system setup screen.

MEMORY		BATTERY	
Total	= 16384KB	Battery Save Mode	= Full Power
DISPLAY		OTHERS	
Display Adaptor	= VGA compatible	Power-up Mode	= Boot
LCD Display Colors	= 256K Colors	CPU Cache	= Enabled
Power On Display	= Internal/External	Level2 Cache	= Enabled
LCD Display Stretch	= Disabled	Auto Power On	= Disabled
		Alarm Volume	= High
		System Beep	= Enabled
PASSWORD		Ext. Keyboard "Fn"	= Disabled
Not Registered		Boot Priority	= FDD→Built-In HDD
		Pointing Devices	= Auto-Selected
		PC Card Controller Mode	= PCIC Compatible
HARD DISK			
Built-in HDD Mode	= Enhanced IDE (Normal)		

↑↓←→: Select items    Space, Bksp: Change values    PgDn, PgUp: Change pages  
Esc: Exit without saving    Home: Set default values    End: Save changes and Exit

*A sample TSETUP screen*

**5 Press P to move to the PASSWORD section of the screen.**

**6 Press the spacebar.**

TSETUP asks you to enter a new password.

**7 Type a password of one to 16 characters and press Enter.**

You may use any combination of letters and numbers in your password.

**8 When TSETUP prompts you to do so, verify the password by typing it again and pressing Enter.**

If the two passwords match, TSETUP displays: Registered.

If the two passwords don't match TSETUP displays an error message. Repeat steps 7 and 8 to enter the password again.

**9 Press End to save your change and close TSETUP.**

TSETUP asks you to confirm your choice.

**10 Press Y to confirm you want to quit.**



*The computer overwrites all existing information on the password service diskette. Make sure the diskette you use does not contain any important information.*

---

TSETUP prompts you to select the type of diskette you inserted.

**11 Press 2 if you're using a 1.44MB diskette or press 1 if you're using a 720KB diskette.**

TSETUP creates the password service diskette and displays a message when it's finished.

**12 Remove the diskette and press any key to continue.**

TSETUP closes, returning you to the system prompt. The next time you start the computer your password will be in effect.

---

**13 Place your password service diskette in a safe place, away from the computer.**

---



*Do not use your password service diskette for any other purpose. If you try to access the diskette, you'll receive an error message, and will have to reset your password and create a new password service diskette.*

---

## Power-On Password

Whenever you start or restart your computer with a power-on password in effect, the computer prompts you to enter the password before it goes through its normal startup procedure. The power-on password operates whether or not the computer is operating in Resume Mode.

When your computer prompts you to enter your password, type it in and press Enter. If you enter the password correctly, the computer continues with its normal startup procedure. If you enter an incorrect password, the computer beeps. After three incorrect attempts, the system turns off automatically.

If you've forgotten your password, follow these steps:

- 1 If your diskette drive is not installed in the SelectBay, connect the external diskette drive or swap drives in the SelectBay. To swap drives, see "Swapping SelectBay Modules" on page 114.**
- 2 Turn the computer on with Resume Mode turned off.**

The system prompts you for your password.

**3 Insert the password service diskette into the diskette drive and press Enter.**

The system prompts you, “Set Password Again (Y/N)?”



*The password service diskette is not reusable. Once you use it, you must create a new diskette, even if you set the same password.*

---

**4 To enter TSETUP and reset your password, press Y. Follow the instructions in “Creating a Password” on page 260 to reset your password.**

To remove your password, press N. It will no longer be registered.

## Instant Password

An instant password secures your system with a single keystroke. Use this feature when you need to leave your desk for a few minutes and don't want to turn the computer off.

To use an instant password, press Fn + F1. Pressing this hotkey freezes the keyboard and AccuPoint and blanks the screen. An instant password has no effect on an optional serial mouse or trackball.

If you have not registered a power-on password, press Enter to unlock your system.

If you have registered a power-on password, follow these steps to unlock your system:

- 1 Press Enter.**
- 2 Enter your password and press Enter.**

If you enter the password correctly, the computer returns to where it was when you pressed the hotkey.



## Disabling a Password

To disable your password, follow these steps:

**1 Click Start, then point to Settings.**

**2 Click Control Panel.**

Windows 95 opens the Control Panel.



**3 Double-click the Toshiba System icon.**

The Toshiba System Control Panel opens.

**4 Click the Security tab.**

**5 In the System Password section of the tab, click Remove.**

The Toshiba System Control Panel displays the Verify Password dialog box.

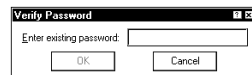

*The Verify Password dialog box*

**6 In the “Enter existing password” box, type your password.**

If the password matches the one you set, the OK button is enabled.

**7 Click OK.**

The Toshiba System Control Panel displays the Security tab with the System Password listed as “Not Registered.”

**8 Click OK to exit the Toshiba System Control Panel.**

**9 Close the Windows Control Panel.**

## Using a Hard Disk Drive Password

Your computer comes with a program pre-installed that lets you set two types of hard disk drive password, User and Master. These passwords protect your hard disk as follows:

- ❖ Setting a hard disk drive User password prevents an unauthorized user from accessing your hard disk, even if it is removed and installed on another computer. This password does not encrypt data on the hard disk.
- ❖ Setting a hard disk drive Master password lets you bypass the hard disk drive User password and access your hard disk, in case you forget the hard disk drive User password. If you choose to set a hard disk drive Master password, you must set it before you set a hard disk drive User password.



*If you choose to set a hard disk drive User password, it is strongly recommended that you set a hard disk drive Master password as well.*

*If you set a hard disk drive User password and later forget the password or lose your password diskette, YOU WILL NEVER BE ABLE TO ACCESS YOUR HARD DISK AGAIN, unless you've set a hard disk drive Master password.*

---

## Setting a Hard Disk Drive Master Password

To set a hard disk drive Master password, follow these steps:

**1 Click Start, then click Shut Down.**

Windows 95 displays the Shut Down Windows dialog box.

**2 Click Restart the computer in MS-DOS mode and click Yes.**

Windows 95 shuts down the computer, then restarts it in MS-DOS mode and displays a system prompt.

- 
- 3 At the system prompt, type `c:\dos\diskpw` and press Enter.**

DISKPW displays a warning screen.

- 4 To set a hard disk drive Master password, type `2` and press Enter.**

To quit without setting a password, type `3` and press Enter.

DISKPW displays another warning and asks you whether you want to set a hard disk drive Master password.

- 5 To set a hard disk drive Master password, type `Y`.**

To exit without setting a password, type `N`.

If you choose `Y`, DISKPW prompts you to enter your password.

- 6 Type a password of up to ten characters and press Enter.**



*Make sure you choose a hard disk drive Master password you can remember easily. If you set a hard disk drive User password and later forget the password or lose your password diskette, you will need to enter the hard disk drive Master password in order to access your hard disk. If you forget the hard disk drive Master password and the hard disk drive User password, YOU WILL NEVER BE ABLE TO ACCESS YOUR HARD DISK AGAIN.*

---

DISKPW prompts you to enter the password again.

- 7 Type the password again and press Enter.**

If the passwords match, DISKPW prompts you to create a password diskette.

- 8 To create a password diskette, type `Y`.**

To continue without creating a password diskette, type `N`.

If you choose to create the diskette, DISKPW prompts you to insert a diskette.

**9 Insert a blank formatted diskette into the diskette drive and press any key to continue.**

DISKPW saves the password on the diskette as a text file. If you forget your password, you can open the text file on another computer and find out what the password is.

DISKPW displays a warning screen and asks if you want to finish setting the hard disk drive Master password.

**10 To finish setting the hard disk drive Master password, type Y.**

To exit without setting a password, type N.

The hard disk drive Master password will be registered the next time you restart your computer. When you need to use the hard disk drive Master password, type the password when prompted and press the tab key.

## Setting a Hard Disk Drive User Password

To set a hard disk drive User password, follow these steps:

**1 Click Start, then click Shut Down.**

Windows 95 displays the Shut Down Windows dialog box.

**2 Click Restart the computer in MS-DOS mode and click Yes.**

Windows 95 shuts down the computer, then restarts it in MS-DOS mode and displays a system prompt.

**3 At the system prompt, type `c:\dos\diskpw` and press Enter.**

DISKPW displays a warning screen.

**4 To set a hard disk drive User password, type 1 and press Enter.**

To quit without setting a password, type 3 and press Enter.

DISKPW displays another warning and asks you whether you want to set a hard disk drive User password.

---

**5 To set a hard disk drive User password, type Y.**

To exit without setting a password, type N.

DISKPW displays another warning and asks you whether you want to set a hard disk drive User password.

**6 To set a hard disk drive User password, type Y.**

To exit without setting a password, type N.

If you choose Y, DISKPW prompts you to enter your password.



*Make sure you choose a hard disk drive User password you can remember easily. If you set a password and later forget the password or lose your password diskette, YOU WILL NEVER BE ABLE TO ACCESS YOUR HARD DISK AGAIN.*

*Toshiba will not be held responsible for any loss of data, any loss of use or access to your hard disk drive, or for any other losses to you or any other person or organization that results from the loss of access to your hard disk drive.*

---

**7 Type a password of up to ten characters and press Enter.**

DISKPW prompts you to enter the password again.

**8 Type the password again and press Enter.**

If the passwords match, DISKPW prompts you to create a password diskette.

**9 To create a password diskette, type Y.**

To continue without creating a password diskette, type N.

If you choose to create the diskette, DISKPW prompts you to insert a diskette.

**10 Insert a blank formatted diskette into the diskette drive and press any key to continue.**

DISKPW saves the password on the diskette as a text file. If you forget your password, you can open the text file on another computer and find out what the password is.

DISKPW displays a warning screen and asks if you want to finish setting the hard disk drive User password.

**11 To finish setting the hard disk drive User password, type Y.**

To exit without setting a password, type N.

The hard disk drive User password will be registered the next time you restart the computer. Each time you start the computer from the hard disk, the system will prompt you to enter your password. When prompted, type your hard disk drive User password and press Enter.

## Deleting the Hard Disk Drive User Password

To delete the hard disk drive User password, follow these steps:



NOTE

*You must delete the hard disk drive User password before you can delete the hard disk drive Master password.*

---

**1 Click Start, then click Shut Down.**

Windows 95 displays the Shut Down Windows dialog box.

**2 Click Restart the computer in MS-DOS mode and click Yes.**

Windows 95 shuts down the computer, then restarts it in MS-DOS mode and displays a system prompt.

**3 At the system prompt, type `c:\dos\diskpw` and press Enter.**

DISKPW displays a warning screen.

- 4 To delete the hard disk drive User password, type 1 and press Enter.**

To quit without deleting the password, type 3 and press Enter.

DISKPW displays another warning and asks you whether you want to delete the hard disk drive User password.

- 5 To delete the hard disk drive User password, type Y.**

To exit without deleting the password, type N.

If you choose Y, DISKPW prompts you to enter your password.

- 6 Type your password and press Enter.**

If the password you typed matches the registered hard disk drive User password, the password is deleted.

- 7 Restart the computer for your changes to take effect.**

## Deleting a Hard Disk Drive Master Password

To delete the hard disk drive Master password, follow these steps:



NOTE

*You must delete the hard disk drive User password before you can delete the hard disk drive Master password.*

- 1 Click Start, then click Shut Down.**

Windows 95 displays the Shut Down Windows dialog box.

- 2 Click Restart the computer in MS-DOS mode and click Yes.**

Windows 95 shuts down the computer, then restarts it in MS-DOS mode and displays a system prompt.

- 3 At the system prompt, type c:\dos\diskpw and press Enter.**

DISKPW displays a warning screen.

- 4 To delete the hard disk drive Master password, type 2 and press Enter.**

To quit without deleting the password, type 3 and press Enter.



*If a hard disk drive User password is set, DISKPW displays a warning and does not delete your hard disk drive Master password.*

---

If there is no hard disk drive User password set, DISKPW displays a warning and asks you whether you want to delete the hard disk drive Master password.

- 5 To delete the hard disk drive Master password, type Y.**

To exit without deleting the password, type N.

If you choose Y, DISKPW prompts you to enter your password.

- 6 Type your password and press Enter.**

If the password you typed matches the registered hard disk drive Master password, the password is deleted.

- 7 Restart the computer for your changes to take effect.**

## Using an Undock (Eject) Password

Turning on the Undock Password option (called the Eject Password in TSETUP) prevents an authorized user from disconnecting the computer from, or attaching the computer to, the optional Desk Station V Plus. This protects both your computer and your data. The undock password is the same as the power-on and instant passwords.



*You must register a password in the Toshiba System Control Panel or TSETUP before you can use the undock password option.*

---



This section provides instructions for setting an undock password through the Toshiba System Control Panel. For information about setting an eject password in TSETUP, refer to “TSETUP” on page 427.

## Setting an Undock Password

To turn the undock password option on, follow these steps:



NOTE

*You must register a password in the Toshiba System Control Panel or TSETUP before you can use the undock password option.*

### 1 Click Start, then point to Settings.

### 2 Click Control Panel.

Windows 95 opens the Control Panel.



### 3 Double-click the Toshiba System icon.

The Toshiba System Control Panel opens with the Start Up Options tab on top.

### 4 Click the Security tab to bring it to the front.

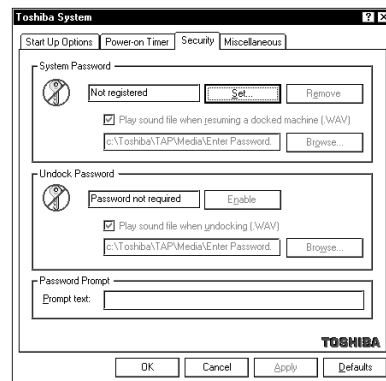

*The Security tab of the Toshiba System Control Panel*

- 5 In the Undock Password section of the dialog box, click Enable.**
- 6 Click OK.**

The Undock Password is registered.

## Removing the Undock Password

To turn the undock password off, follow these steps:

- 1 Click Start, then point to Settings.**
- 2 Click Control Panel.**

Windows 95 opens the Control Panel.



- 3 Double-click the Toshiba System icon.**

The Toshiba System Control Panel opens with the Start Up Options tab on top.

- 4 Click the Security tab to bring it to the front.**
- 5 In the Undock Password section of the dialog box, click Remove.**

The Toshiba System Control Panel displays the Verify Password dialog box.

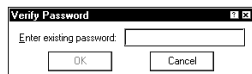

*The Verify Password dialog box*

- 6 Type your password in the Enter existing password box.**

If the password matches the one you set, the OK button is enabled.

- 7 Click OK.**

The Toshiba System Control Panel displays the Security tab with the Undock Password listed as "Password not required."

## Viruses and How to Cure Them

Over the last few years, there have been a number of computer virus scares. Immoral pranksters seem to enjoy unleashing these potentially destructive programs on the general public.

Viruses, while a potential problem, need not have a devastating effect on your computer. By taking a few simple precautions, you can avoid infection. And, by making sure you have a complete backup of all your programs and data files, you can ensure a speedy recovery if you do run into problems.

There are many virus detection/removal programs available. Ask your dealer for help in selecting one that adequately meets your needs.

# Making Life Easier

---

Your Tecra 740CDT computer is a computing powerhouse right out of the box. You can run the most powerful business programs and work for hours away from an external power source without needing to change anything. By using the additional built-in features of your computer, you can make your life even easier.

This chapter discusses some convenient options that are already included with your computer.

## **Saving Time with Multiple Configurations**

Imagine it's time to go home at the end of the day's work. You've been using your computer all day to send financial data to corporate headquarters, access the corporate database and run a statistical package. You take the computer home with you so you can write some memos and help your son or daughter with their homework.

In the office, you want your Toshiba Access Panel to contain the icons that launch the programs you use most frequently for work. At home, you need your word processor and possibly a game or two to play when your child's homework is finished.

The Toshiba Access Panel allows you to set up a maximum of five distinct configurations. Three configurations (Home, Office, and Travel) were already set up when you turned the computer on. You can customize these preset configurations and define two additional configurations.



*A configuration specifies the basic features of your system. A Toshiba Access Panel configuration specifies the power and battery settings, Fn-esse assignments, the gauges displayed on the panel and which programs to launch from the panel.*

---

## Which Configuration Am I Currently Using?

The icon on the configuration button, at the top of the panel, identifies the current configuration.



*Home, Office and Travel configuration buttons*

The configuration you choose can affect all aspects of the panel including hardware configuration settings, how the battery gauges display, and which programs you can launch from the panel.

## Changing Configurations

To change your current configuration, click the configuration button. The configuration slider bar appears, displaying the available configurations. Click the button for the configuration you wish to use.

## More Reasons to Use Configurations

Using multiple configurations can greatly simplify your computer use. For example, if you use your computer to take notes during business meetings, you might want to decrease the volume of the battery alarm so as not to interrupt the meeting. Later at home, you may want the alarms to sound at full volume.

If you've customized your office and home configurations with this in mind, all you need to do when you arrive at your meeting is click the office configuration button, and you're ready to take notes without fear of interruption.

Perhaps you always use the power cord to power the computer when you're at home or at the office. In both places you have no need for the power usage options because you're not using the battery. When you travel, however, you want to take advantage of the computer's battery-saving features. One click on the travel configuration button, and your system is ready to go on the road.

## Managing Configurations

To access the configuration options, follow these steps:



- 1 Click the Options button at the bottom of the Toshiba Access Panel.**

A bar of options slides out.



- 2 Click the Configuration Management button on the slider bar.**

The panel opens the Configuration Management dialog box.

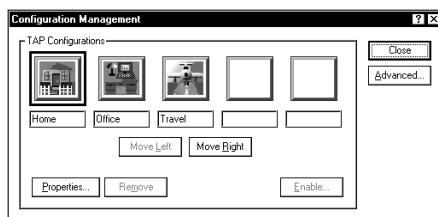

*Configuration Management dialog box*

- 3 To modify an existing configuration, click its button, then click Properties.**

The panel displays the Configuration Properties dialog box, which lets you change the name and icon for the configuration.

- 4 To remove an existing configuration, click its button, then click Remove.**

- 5 To create a new configuration, click one of the unused configuration buttons, then click Enable.**

The panel displays the Enable Configuration dialog box, which lets you select a name and icon for the new configuration. It also prompts you to select the existing configuration on which to base the new configuration.

- 6 To reorder a button on the slider bar, select the button and click Move Right or Move Left.**

## Creating Your Own Button Icon

The button icons used to identify the configuration are small bit-map drawings (45 x 42 pixels). To assign a unique icon to one of the configuration buttons, locate a piece of clip art you like or create an icon using a drawing program.



An icon is a small drawing that represents a task, function or feature.

A pixel is the smallest area of the screen that the system can control. Some screens contain a total of 640 x 480 pixels. Others contain 800 x 600 pixels. All information displayed consists of combinations of colored or black and white pixels.

Clip art is the term that refers to computer-ready graphics you can buy from a graphics company or over the Internet.

A bitmap is a drawing that consists of tiny dots (in this case, pixels) that when viewed from a distance form a picture.

If you draw an icon, save it as a bitmap or icon, making sure it has the extension .BMP or .ICO. Save it or copy it to the c:\toshiba\tap\images folder.

To assign your icon to a configuration button, follow these steps:

- 1 In the Configuration Management dialog box, click the configuration button you wish to modify.**
- 2 Click Properties.**

The Configuration Properties dialog box opens.

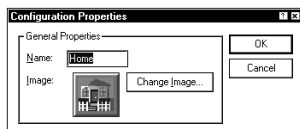

*The Configuration Properties dialog box*

- 3 To change the configuration name, type the new name in the Name box.**
- 4 To assign a new icon to the configuration, click Change Image.**

The Change Configuration Image dialog box opens.



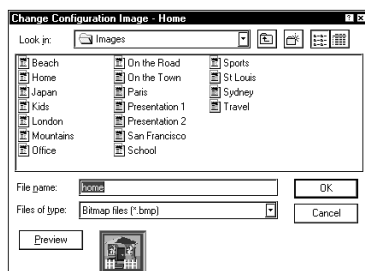

*The Change Configuration Image dialog box*

The example above shows the name of the bitmap file for the Travel configuration icon.

**5 Select the desired file.**

Use the Look in box to specify the folder in which the file is located, and the Files of type box to list either bitmaps or icons.

**6 To view a bitmap or icon before you commit to using it, click Preview.**

The system displays the icon to the right of the Preview button.

**7 Once you've found the icon you want to use, click OK to exit the dialog box with the change in effect.**

**8 Click OK to close the Configuration Properties dialog box.**

**9 Click Close to close the Configuration Management dialog box.**

## Choosing When to Automatically Change Configurations

The computer can change configurations automatically under these conditions:

- ❖ When using AC power
- ❖ When using battery power
- ❖ When using a specific Windows 95 hardware configuration (if multiple configurations exist)

To define when you want the configuration change to occur:

**1 In the Configuration Management dialog box, click Advanced.**

The Advanced Configuration Management dialog box opens.

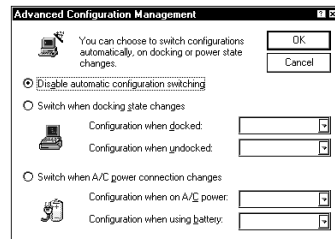

*The Advanced Configuration Management dialog box*

**2 Select the appropriate setting:**

- ❖ Choose Disable automatic configuration switching if you plan to change the configuration yourself by clicking the configuration button on the Toshiba Access Panel.
- ❖ Choose one of the other settings to cause the system to change configurations automatically.

**3 Click OK to close the Advanced Configuration Management dialog box.**

**4 Click Close to close the Configuration Management dialog box.**

## Creating Your Own Configuration

To use one of the blank buttons to create your own configuration, follow these steps:

**1 In the Configuration Management dialog box, click a blank configuration button.**

**2 Click Enable.**

The Enable Configuration dialog box opens.

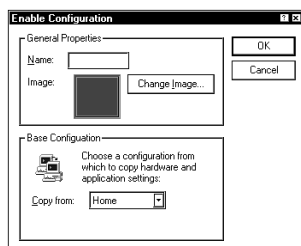

*The Enable Configuration dialog box*

**3 Type a name for the configuration in the Name box.**

**4 Assign the icon for the button.**

The procedure for assigning the icon using this dialog box is the same as the procedure for assigning the icon using the Configuration Properties dialog box. See “Creating Your Own Button Icon” on page 282.

**5 Choose one of the existing configurations from which to copy the hardware and application settings.**

You must copy settings from an existing configuration when you create a new one. In the next section, you’ll see how to change the settings for your new configuration.

**6 Click OK to close the Enable Configuration dialog box.**

**7 Click Close to close the Configuration Management dialog box.**

## Changing Configuration Settings

You customize hardware settings after you’ve created a new configuration. Both the MaxTime Control Panel and the Toshiba System Control Panel include configurations buttons for assigning the current settings to your chosen configuration.

## Changing Power Usage Settings



All power usage settings are controlled by the MaxTime Control Panel. The easiest way to configure the system's power settings is by clicking the MaxTime Wizard button on the Toshiba Access Panel. This starts the MaxTime Wizard, which asks you a series of questions, then selects power settings based on how you prefer to work and assigns the settings to the appropriate configurations.

If you prefer to control each power usage option individually, you can do so through the MaxTime Control Panel. To access the MaxTime Control Panel, follow these steps:

- 1 Click Start, then point to Settings.**
- 2 Click Control Panel.**

Windows 95 opens the Control Panel.



MaxTime

- 3 Double-click the MaxTime icon.**

The MaxTime Control Panel opens.



You can also open the MaxTime Control Panel by double-clicking the Toshiba Power icon on the right corner of the Windows 95 taskbar.



- 4 Click the configuration button to assign settings to a specific configuration.**

The computer displays this icon any time you can assign an option to a specific configuration.

MaxTime displays a power usage dialog box for the current power source.

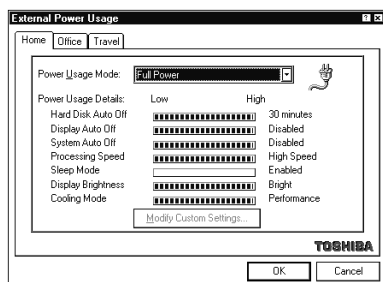

The External Power Usage dialog box

Each configuration is represented by a tab.

- 5 Click the tab for the configuration you want to change.**
- 6 Choose one of the Power Usage Modes from the list box:**
  - ❖ Low Power conserves power when you're using the battery.
  - ❖ Full Power maximizes system performance.
  - ❖ Custom Settings lets you set each power usage option individually. For more information about each of these options see "Conserving Power" on page 154.
- 7 Click OK to close the dialog box.**
- 8 Click OK to exit the MaxTime Control Panel.**

## Changing Battery Alarm Settings

You control the battery alarm settings through the MaxTime Control Panel. To set up separate battery alarms for each of your configurations, follow these steps:

- 1 Click Start, then point to Settings.**
- 2 Click Control Panel.**
- 3 Double-click the MaxTime icon.**



MaxTime

Windows 95 opens the Control Panel.

The MaxTime Control Panel opens with the Power Settings tab on top.

**4 Click the Battery Alarms tab to bring it to the front.**

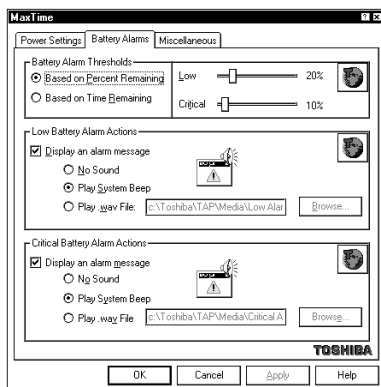

*The Battery Alarms tab of the MaxTime Control Panel*



**5 Click the configuration button in the Battery Alarm Thresholds section.**

The MaxTime Control Panel displays the Battery Alarm Threshold dialog box.

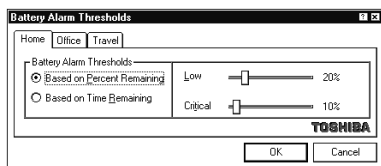

*The Battery Alarm Threshold dialog box*

This dialog box displays a tab for each configuration.

**6 Click the tab for the configuration you wish to change.**

**7 Select the threshold that will trigger the battery alarm:**

- ❖ To set the alarm to sound when the battery charge reaches the Time Remaining Threshold, click “Based on Time Remaining.”
- ❖ To set the alarm to sound when the battery charge reaches the Percent Remaining Threshold, click “Based on Percent Remaining.”

**8** Select the threshold levels that will trigger the alarms by moving the Low and Critical sliders in the Battery Alarm Thresholds section.

**9** Click OK to exit the Battery Alarm Thresholds dialog box.



**10** Click the configuration button in the Low Battery Alarm Actions section.

The MaxTime Control Panel displays the Low Battery Alarm Actions dialog box.

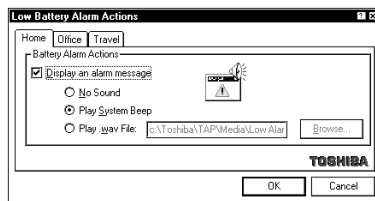

*The Low Battery Alarm Actions dialog box*

**11** Click the tab for the configuration you wish to change.

**12** To configure the system to display a warning message for the Low Battery Alarm, select Display an alarm message.

If you select this option, you can also select a sound event to occur when the Low Battery Alarm warning displays: No Sound, Play System Beep, or Play .wav File.

**13** Click OK to exit the Low Battery Alarm Actions dialog box.

**14** Repeat steps 10 through 13 in the Critical Battery Alarm section of the dialog box.

**15** Click OK to save your settings and close the MaxTime Control Panel.

## Changing Warning Volumes

You can set the warning volumes through the Toshiba System Control Panel. To assign volume settings to a specific configuration, follow these steps:

**1 Click Start, then point to Settings.**

**2 Click Control Panel.**

Windows 95 opens the Control Panel.



**3 Double-click the Toshiba System icon.**

The Toshiba System Control Panel opens.

**4 Click the Miscellaneous tab to bring it to the front.**

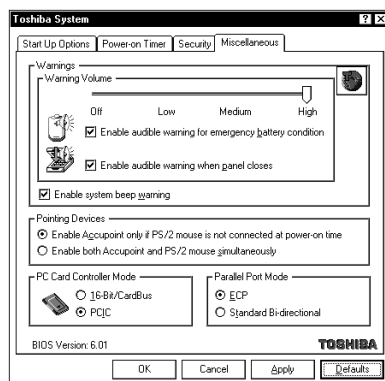

*The Miscellaneous tab of the Toshiba System Control Panel*



**5 Click the configuration button in the Warnings section of the tab.**

The Toshiba System Control Panel displays the Configuration Specific Alarm dialog box.



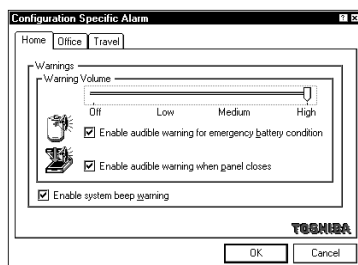

*The Configuration Specific Alarm dialog box*

- 6 Click the tab of the configuration for which you want to change the warning settings.**
- 7 Change the desired warning settings, then click OK to exit the dialog box.**
- 8 Click OK to exit the Toshiba System Control Panel.**

## Starting Programs Faster with Fn-esse

You may think that when you have one Windows program open and want to open a different program, you must click Start, point to Programs and click the icon for the program you want to open. Not necessarily—Windows 95 shortcuts and Toshiba's Fn-esse program provide quick ways to open programs, documents and folders from within any Windows program. For more information on making Windows 95 shortcuts see “Lesson 8: Creating Shortcuts” on page 66. The following section describes how to use the Fn-esse program to quickly access your programs and files.

You can assign a Fn key combination to:

- ❖ Open a Windows program.
- ❖ Open a file in its associated Windows program.
- ❖ Display a customized folder of Windows programs and/or files from which to choose.

You can assign any key that is not associated with a hotkey or a keyboard overlay. This section explains how to assign your Fn key combinations and use them to open programs and documents quickly.

## Starting Fn-esse

To start Fn-esse, click the Fn-esse button on the Toshiba Access Panel.

Fn-esse opens and displays the Fn-esse keyboard.



*The Fn-esse keyboard*

The keys are coded as follows:

- ❖ Black keys are available keys (not yet assigned).
- ❖ Colored keys are assigned (blue is the default color).
- ❖ Dark gray keys are not assignable.
- ❖ Keys with a small triangle on the upper left corner open either a program folder or a custom folder.

To view an existing key assignment, position the pointer over the key on the Fn-esse keyboard. A pop-up hint displays which program, file or folder is associated with the key.

If a key is unassigned, the hint reads “No Assignment.”

## Assigning Keys

You can assign a file, program folder, or custom folder to a Fn key combination by:

- ❖ Clicking the key on the Fn-esse keyboard, pointing to Assign To, then clicking File, Program Folder, or Custom Folder.
- ❖ Dragging a program or file icon from the Windows Explorer and dropping it onto a key on the Fn-esse keyboard.
- ❖ Clicking a file or folder with the secondary button, then choosing Assign to Fn key from the shortcut menu that appears.

The following sections discuss the first two methods listed above.

### Assigning a Key to a Program or a File

To assign a key combination the task of opening a program or file and its associated program, follow these steps:

- 1 Open Fn-esse.**
- 2 Click the desired key in the Fn-esse keyboard.**

Fn-esse displays a shortcut menu.

- 3 Point to Assign To.**

Fn-esse allows you to choose between File, Program Folder and Custom Folder.

- 4 Click File.**

Fn-esse displays the Assignment dialog box with the Assignment Type set to File.

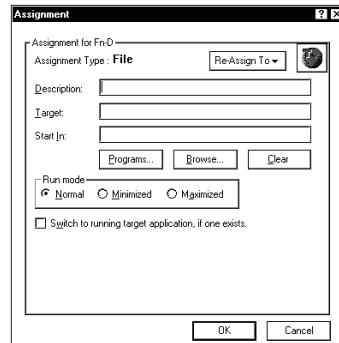

*The Assignment dialog box*

**5 Fill in the Description, Target and Start in text boxes with the file information, or click Programs or Browse to choose your file from a list:**

- ❖ Clicking Programs displays the Programs Browser dialog box, which lists the items in the Programs menu.
- ❖ Clicking Browse displays the Open dialog box, which allows you to select your file from a directory tree.

**6 Click the folder which contains the program or file you want to assign.**

Fn-esse displays the selected folder's contents.

**7 Click the program icon (or the file icon) to which you want to assign the Fn key combination.**

**8 Exit the dialog box:**

- ❖ Click OK if you're in the Programs Browser.
- ❖ Click Open if you're in the Open dialog box.

Fn-esse displays the Assignment dialog box with the Description, Target and Start in text boxes filled in.

**9 Choose a Run Mode:**

- ❖ Clicking Normal starts the program in a normal window on the desktop.
- ❖ Clicking Minimized starts the program without opening a window on the desktop. It also adds an icon to the taskbar.
- ❖ Clicking Maximized starts the program in a window that fills the desktop.

**10 To re-activate a program (rather than open a second copy) if it is already running when you press its assigned Fn key combination, select “Switch to running target application, if one exists.”**



NOTE

*This option does not function with the Windows Explorer.*

---

**11 Click OK to save your key assignment and exit the dialog box.**

The program or document is now associated with the key you just selected. To open the program or file, press Fn plus the appropriate key from within Windows.

## Assigning a Key to a Program Folder

To assign a key the task of opening a program folder, follow these steps:

- 1 Open Fn-esse.**
- 2 Click the desired key in the Fn-esse keyboard.**

Fn-esse displays a shortcut menu.

- 3 Point to Assign To.**

Fn-esse allows you to choose between File, Program Folder and Custom Folder.

**4 Click Program Folder.**

Fn-esse displays the Assignment dialog box, with the Assignment Type set to Program Folder.

**5 Fill in the Description and Target text boxes with the folder information or click Program Folders to choose your folder from the Program Folder Browser.**

Fn-esse displays the Program Folder Browser with a list of program folders in the left side of the screen.

**6 Click the folder to which you want to assign the Fn key combination.**

Fn-esse displays the contents of the selected folder on a shaded background, indicating the individual programs and folders are unavailable.

**7 Click OK.**

Fn-esse displays the Assignment dialog box with the Description and Target text boxes filled in.

**8 Click OK to save your key assignment and exit the dialog box.**

The program folder is now associated with the Fn key combination. To open the program folder, press Fn plus the appropriate key from within Windows.

## Assigning a Key to a Custom Folder

To create a custom folder and assign a key combination to the task of opening that custom folder, follow these steps:

**1 Open Fn-esse.**

**2 Click the desired key in the Fn-esse keyboard.**

Fn-esse displays a shortcut menu.

**3 Point to Assign To.**

Fn-esse allows you to choose between File, Program Folder and Custom Folder.

**4 Click Custom Folder.**

Fn-esse displays the Assignment dialog box, with the Assignment Type set to Custom Folder.

**5 Type a name for your custom folder in the Description field.**

**6 To add programs or files to your custom folder, click Add.**

Fn-esse displays a directory tree that allows you to select a program or file.

**7 Select the program or file you want to add to your custom folder.**

The browser displays the file name you select in the text field.

**8 Click Open.**

Fn-esse displays the Assignment dialog box and adds the selected program or file to the list of files in the custom folder.

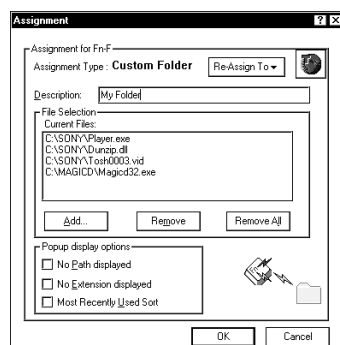

*The Assignment dialog box with the added files*

**9 In the Popup display options section of the dialog box, select how the items in the pop-up list will display:**

- ❖ No Path displayed displays the program or file without the path.
- ❖ No Extension displayed displays the program or file without the file extension.
- ❖ Most Recently Used Sort displays the programs and files ordered by most recent usage.

**10 To remove a file from the list of current files, select the file and click Remove.**

To remove all files from the current list, click Remove All.

**11 Click OK to save your key assignment and exit the dialog box.**

The custom folder containing the files you selected is now associated with the Fn key combination. To open the custom folder, press Fn plus the appropriate key from within Windows.

## Using Drag-and-Drop

You can also assign a key combination to a program or file by dragging the icon for the program or file from the Windows Explorer and dropping it onto one of the keys on the Fn-esse keyboard. To use the drag and drop method to assign tasks to keys, follow these steps:

- 1 Open both Fn-esse and the Windows Explorer.**
- 2 Resize the Explorer window so you can see both the Fn-esse keyboard and the Explorer at the same time.**

If you're unsure how to do this, refer to "Lesson 6: Resizing and Reshaping Windows" on page 63.

- 3 In the Explorer window, highlight the program or document file to which you wish to assign a key.**



- 4 Drag the highlighted item from the Explorer to the key on the Fn-esse keyboard to which you wish to assign it.**

Fn-esse displays the Assignment dialog box completely filled in to reflect the selected program or document.

- 5 Click OK to close the Assignment dialog box with your key assignment in effect.**

The program or document is now associated with the key you just selected. To open the program or document, press Fn plus the appropriate key from within any Windows program.

## Changing or Removing Existing Key Assignments

To change or remove an existing key assignment, follow these steps:

- 1 Click the key on the Fn-esse keyboard you wish to change.**

Fn-esse displays a shortcut menu.

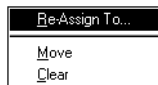

*The shortcut menu*

- 2 To Re-assign the key to the task of opening a program, a document or a folder, click Re-assign to.**

When Fn-esse displays the Assignment dialog box, click Re-assign To, select the new task and follow the instructions earlier in this section for assigning that task.

- 3 To move the existing key assignment to another key, click Move and click the new key.**

The previously assigned key becomes black. The newly assigned key changes color, indicating it is now an assigned key.

- 4 To remove the key assignment, click Clear, then click Yes.**

The key becomes black.

## Setting Options

This section describes the options you can set by clicking the Options button on the Fn-esse keyboard, then clicking the Options tab in the Fn-esse Options dialog box.

### Notifying on Launch

If you select the check box next to Notify on Launch, Fn-esse displays the title while it opens the assigned program or file.

### Confirming Changes in Existing Key Assignments

If you select the check box next to Confirm Key Changes, Fn-esse asks you to confirm changes in existing key assignments.

### Setting Colors

To choose colors for each of the three assigned key tasks, follow these steps.

- 1 To change the color of the assigned keys, select the desired color from the Assigned Keys list box.**
- 2 To change the color of the triangle that indicates program folders, select the desired color from the Program Folder list box.**
- 3 To change the color of the triangle that indicates custom folders, select the desired color from the Custom Folder list box.**
- 4 Click Apply to apply the new colors to your Fn-esse keyboard.**
- 5 Exit the dialog box:**
  - ❖ Click OK to save your new settings and exit the dialog box.
  - ❖ Click Cancel to cancel your new settings and exit the dialog box.

## Using Fn-esse with an External Keyboard

You can use Fn-esse even if you're working with an external keyboard that doesn't have an Fn key. To set a key combination to emulate the Fn key, follow these steps:

**1 Click the Options button on the Fn-esse keyboard.**

Fn-esse displays the Fn-esse Options dialog box with the Options tab in front.

**2 Click the Ext Keyboard Fn Key tab.**

Fn-esse displays the tab.

**3 Click the button next to the external key combination you wish to emulate the Fn key.**

**4 Click OK.**

The key combination is assigned. When you use the external keyboard, use this key combination instead of pressing Fn.

## Making the Key Assignment Configuration Aware

You can assign key combinations to different tasks in each of your Toshiba Access Panel configurations. To assign a Fn key combination to a task in a specific configuration, follow these steps:

**1 Open Fn-esse.**

**2 Click the desired key in the Fn-esse keyboard.**

Fn-esse displays a shortcut menu.

**3 Point to Assign To.**

**4 Select File, Program Folder, or Custom Folder.**

Fn-esse displays the Assignment dialog box.

**5 Click the configuration button.**

Fn-esse displays the Assignment for Fn-*x* dialog box, where Fn-*x* is the key combination to which you're assigning the task.

This dialog box provides tabs for each of the configurations.

- 6 Click the tab for the configuration in which you want to assign the Fn key combination.**
- 7 Follow the instructions in “Assigning a Key to a Program or a File,” “Assigning a Key to a Program Folder,” or “Assigning a Key to a Custom Folder” to finish assigning the key combination.**
- 8 Click OK.**
- 9 Fn-esse returns you to the Assignment dialog box.**
- 10 Click OK to save your key assignment and exit the dialog box.**

The program folder is now associated with the Fn key combination. To open the program folder, press Fn plus the appropriate key from within Windows.

## Using Device Manager to Configure the Computer

The Windows 95 Device Manager lets you set up many of the individual components of your system. You'll need to use it if, for example, you want to change the COM port name assigned to the serial port or the range of memory reserved for the display adapter. This section gives a brief overview of how to use Device Manager.

To change a component's setting in Device Manager, follow these steps:

- 1 Click the My Computer icon with the secondary button.**
- 2 Click Properties.**

Windows 95 opens the System Properties dialog box.

- 3 Click the Device Manager tab.**

The System Properties dialog box moves to the Device Manager page.

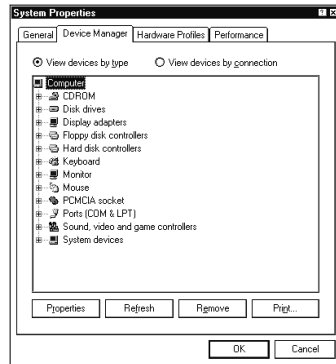

*The Device Manager*

This page lists all of the components of the system that you can change through Device Manager.

- 4 Double-click the device you want to modify. For example, if you want to modify the serial port settings, double-click Ports.**
- 5 Click the Resources tab to move to the Resources page.**
- 6 Make the desired changes.**



**NOTE**

*If you're unfamiliar with working with the computer's configuration, it's a good idea to leave the Use Automatic Settings box checked. These settings were set to work together within the system and with most available optional devices.*

---

- 7 Click OK when you've finished your changes.**

## Working with the Keyboard

This section introduces additional keyboard options.

## Making Your Keyboard Pretend it Has More Keys

The 101-key enhanced keyboard has two Enter, Ctrl and Alt keys. The computer's built-in keyboard has only one of each.

Most of the time there's no difference between the two keys. However, some programs assign separate functions to the right and left Ctrl and Alt keys, or to the regular and numeric pad Enter keys on the enhanced keyboard. The Fn key allows the keyboard to simulate these separate keys, as follows:

- ❖ Press Fn + Ctrl to simulate the Ctrl key on the right side of the enhanced keyboard.
- ❖ Press Fn + Alt to simulate the Alt key on the right side of the enhanced keyboard.
- ❖ Press Fn + Enter to simulate the Enter key on the numeric pad of the enhanced keyboard.

## The Cursor Control Overlay

The keys with the white arrows and white symbols on the left front are the cursor control overlay. This illustration highlights the keys in the cursor control overlay:

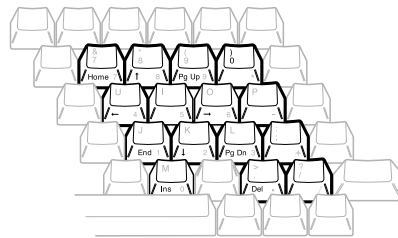

### *The cursor control overlay*

You can use these keys to:

- ❖ Move the cursor up, down, left or right on the screen.
- ❖ Move up or down one page.
- ❖ Move to the beginning or end of a document.
- ❖ Delete or insert characters.

How these keys function may vary with the program you're using. Check your program's documentation for information on how the cursor keys function.

To turn the cursor control overlay on and off, press Fn + F10. The cursor control light on the indicator panel shows whether the cursor control overlay is on or off.

You can use the overlaid keys to type alphabetic characters while the overlay is on. To do this:

- ❖ For lower case letters, press and hold Fn while you type.
- ❖ For upper case letters, press and hold Fn + Shift while you type.

The keys of the cursor control overlay also act as a numeric overlay, providing the numeric keys of a ten-key numeric keypad. To use the numeric keys when the cursor control overlay is on, press and hold Shift while you use the overlaid keys. To return to the cursor control overlay, release Shift. For more information on the numeric overlay, refer to "Typing Numbers" on page 91.

## Different Ways to Turn the Computer On

Now that you've mastered turning your computer on by pressing the power button, it's time to learn some new tricks. This section explains how to:

- ❖ Set the computer to turn on automatically at a time and date you choose. This option is helpful if you are expecting to receive files by modem and want to do the transfer at night, when the rates are cheaper. You can set the computer to turn on and receive the files while you are asleep. This option is called Power-on Timer in the Toshiba System Control Panel, and Alarm Power On in TSETUP.

- ❖ Turn the computer on and off by opening and closing the display panel. This option not only makes it easier to turn the computer's power on, but makes it impossible to close the display panel while the computer is on. This option is called "Trigger suspend/resume when panel closes/opens" in the Toshiba System Control Panel, and "Panel Power On/Off" in TSETUP. This option is only available if you turn Resume Mode on.

This section shows you how to change the options using the Toshiba System Control Panel. For information on using TSETUP, refer to "TSETUP" on page 427.

Follow these steps:

**1 Click Start, then point to Settings.**

**2 Click Control Panel.**

Windows 95 opens the Control Panel.

**3 Double-click the Toshiba System icon.**



The Toshiba System Control Panel opens with the Start Up Options tab on top.

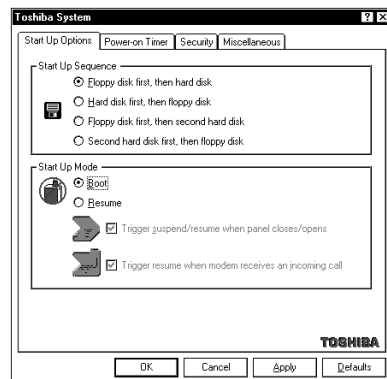

*The Start Up Options tab of the Toshiba System Control Panel*

**4 In the Start Up Mode section, select Resume Mode.**



- 5 To set the computer to turn on or off when you open or close the display panel, select “Trigger suspend/resume when panel closes/opens.”
- 6 Click the Power On Timer tab.

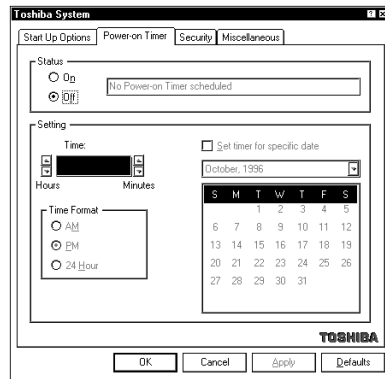

*The Power On Timer tab of the Toshiba System Control Panel*

- 7 To turn the computer on at a particular time, select **On**.
- 8 Select the **Time Format** you wish to use, then click the up and down arrows until the **Time** box displays the desired time.
- 9 To select a specific date, select “Set timer for specific date,” then select the month and date from the calendar.
- 10 Click **OK** to exit the Toshiba System Control Panel.

## Changing the Display Mode

Perhaps you would like to change how much information your screen displays, or adjust the number of colors it uses. You can control these options by using the Display Properties dialog box.

To change your display mode, follow these steps:

**1 With the pointer positioned over a blank area of the desktop, click the secondary button.**

**2 Click Properties.**

Windows 95 opens the Display Properties dialog box.

**3 Click the Settings tab to move to the Settings page.**

**4 Change the number of colors the display can show by changing the Color palette setting.**

**5 Change the screen resolution by clicking and dragging the Desktop area slider.**

**6 When you've made all your changes, click OK. To close the Display Properties dialog box without enabling your changes, click Cancel.**

Windows 95 may ask you to set up your display. If you get this message, choose SVGA from the list of display options.



NOTE

*If you're using a display mode, such as SVGA, that uses more space than the built-in display has available, the display goes into virtual display mode. In this mode, the display pretends it's bigger than it really is by stretching the Windows desktop so that part of it is off the screen. To see the remainder of the desktop, move the pointer to the edge of the display and keep moving it in the direction of the part of the desktop you would like to see.*

*Display modes that use less than the maximum resolution of the internal display (1024 x 768) use a smaller area of the screen. In these modes, you'll see a black border around the screen image.*

# What's Really Going On?

---

You can use your computer without knowing what the various components do, just as you can drive your car without knowing what is under the hood. However, people who understand auto mechanics usually find their knowledge is useful, helping them to get the best out of their vehicles.

Knowing your computer's hardware functions can be helpful in the same way. This chapter gives you details of how your computer works.

## What Is a Computer?

Your computer consists of a number of components. Some of these—like the display panel, keyboard, PC Card slots, serial port and parallel port—you are already familiar with. Others are hidden away inside the case.

The hidden components are the processor, main memory and PCI bus.

## What Is a Processor?

The processor is the computer's engine; it is where the actual computing takes place. Your Tecra 740CDT computer contains an Intel Pentium processor chip with MMX Technology, which operates at 166 MHz. It incorporates a math co-processor for high speed numerical calculations, and 32KB of cache memory to boost performance further.

Cache reduces the time the processor spends waiting while new data is retrieved from main memory for processing or results are stored. By default, main memory is accessed only when necessary to update the cache contents. This caching policy is known as write-back and gives the best performance. You can choose a write-through policy instead. It accesses the main memory every time the processor handles data. See "TSETUP" on page 427 for details of how to set caching policy.

Because it has a relatively high power consumption, the processor could overheat when you are working with large spreadsheets or databases, or doing intensive manipulation of graphics. To prevent this happening, the chip has a cooling fan and an internal temperature sensor. If the temperature rises above a certain level, the fan is turned on and/or the processing speed is reduced.

Again, you can choose the cooling policy in the MaxTime Control Panel or TSETUP. If you are using an AC outlet, you will probably want to use the fan for cooling so that you maintain the computer's performance. If you are using battery power, you may choose to reduce processor speed and sacrifice performance to conserve the battery.

## What Is Main Memory?

The computer stores data it is currently using, such as a document you are writing, in memory. Accessing data in memory is much faster than accessing it on a disk, but is slower than accessing cache.

The amount of memory has a significant effect on your computer's performance. This is because, when Windows runs out of memory, it uses the hard disk as an overflow work area. You need to keep 15% of your hard disk space free for Windows to use in this way.



---

*If your hard disk is more than 85% full, the system will keep crashing as Windows runs out of space for the memory overflow.*

---

For optimum performance you need Windows to make as little use of the overflow area as possible. The more actual memory your computer has, the fewer work files will overflow onto the hard disk.

Your Tecra 740CDT computer came with 16 MB of EDO DRAM (Extended Data Output Dynamic Random Access Memory), which is sufficient for most purposes. However, if you use CAD or DTP software or have a very large database, you may find your computer is slower than you'd expected. If this happens, installing more memory should give you a significant increase in performance.

Before you rush out and buy a memory upgrade, there is another aspect to consider—power consumption. Memory chips use a lot of power. If you normally run your computer from an AC outlet, that isn't a problem.

But, if you travel a lot, the extra memory will mean you need to charge the battery more often. In this case, ask yourself whether you really need the extra performance. If the answer is yes, you probably need to buy a battery charger and extra battery packs as well as the memory card.

## What Is a PCI Bus?

The system bus is the electronic highway that connects the processor with the memory, display, disk/CD-ROM drives, PC Card slots and ports. It is the path along which data flows.

PCI (Peripheral Component Interface) is a particular type of system bus. It provides a 32-bit highway, which means that it can transfer 4 bytes of data (4 characters) at a time.

Besides being the fastest system bus in general use, PCI bus provides plug and play technology, so installing additional devices is easy.

## How Does a Disk Store Information?

The answer depends on the type of disk.

### Hard Disk and Diskettes

Hard disk and diskette drives work in the same way, although the hard disk has a much higher capacity and provides much faster data access than a diskette.

Like a tape recorder, a disk drive reads and writes magnetically encoded information on magnetic media. The drive positions a read/write head above the surface of the disk when it records and retrieves information.

Before a drive can read from or write to a disk, the disk must have a specific structure. Formatting a disk creates this structure.

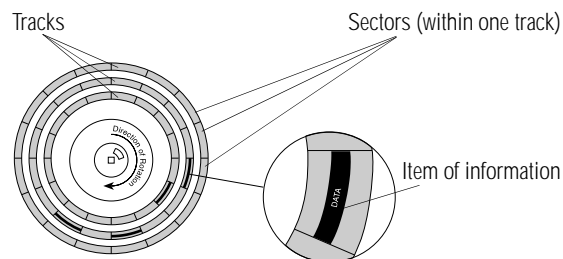

*Tracks and sectors of a disk*

Formatting divides each side of the disk into concentric circles called tracks. Each track is divided into sectors. Each item of information stored on a disk has a specific address composed of its side, track and sector number. This address makes it possible for the computer to locate the information on the disk.

A diskette has just two surfaces. A hard disk consists of a set of platters on a central spindle. So it has several surfaces, with a read/write head for each.

The amount of data a disk can hold depends on how it is formatted. In double-density format it holds 720KB, in high-density format it holds 1.44MB. Your computer's diskette drive can handle both formats.

A hard disk holds as much data as several hundred diskettes. Your computer's hard disk holds 2.1 billion bytes (2.02 gigabytes).

## How Big Is a Gigabyte, Anyway?

You may be wondering what the terms kilobyte, megabyte and gigabyte mean. In normal metric terminology, kilo means thousand, mega means million, and giga means billion. But computer terminology is different.

Computers use base two arithmetic, also called binary arithmetic. Because of this, all numbers in computing are based on powers of two. One megabyte is actually equal to 1,048,576 bytes ( $2^{20}$ ), the closest binary number to 1,000,000. One gigabyte is 1,024 megabytes.

## Compact Discs

Like an audio CD, a CD-ROM is an optical storage medium. Data is stored on concentric tracks on one side of the disc, and the read head incorporates a laser beam.

Unlike hard disk drives, which rotate at a constant speed, a CD-ROM drive changes its rotational speed according to which part of the CD it is accessing. This allows the laser to read data at a constant speed regardless of whether it is accessing an inner or an outer track. Because of the momentum of the disc, this continuous

acceleration and deceleration means that accessing data is slower than for a hard disk.

Your computer is supplied with a 10X\* speed CD-ROM. That means it rotates ten times faster than an audio CD. However, the rotational speed of the drive is only one factor in the performance equation. The size and type of the drive buffer, the head movement mechanism and the type of interface all affect performance.

The measures of performance are:

- ❖ Transfer rate, the speed with which the drive can transfer data to the host PC.
- ❖ Seek time, the time taken to move the laser read head to a particular part of the CD.

For small files which are read directly from the buffer, transfer rates are high. But the speed drops once the buffer overflows.

Although a CD-ROM is no match for a hard disk drive in terms of transfer rate and seek time, it is faster than a diskette. Also it holds a far greater amount of data than a diskette—640 MB against 1.44 MB. That means it can hold a complete set of programs, a catalog, or a multimedia encyclopedia. A typical integrated suite of programs for the office takes approximately 30 diskettes, but it fits comfortably onto a CD.

## How Does the Screen Display Information?

Your computer's built-in screen is a liquid crystal display (LCD) panel. There are two types—STN (Super Twist Nematic) and TFT (Thin Film Transistor). TFT screens provide richer colors. Also, if you need to give presentations to one or two people they are a better choice because the screen is easier to read at an angle and in natural light. (For presentations to larger groups, you need to connect an external monitor to your computer.)

However, TFT screens are more expensive than STN screens and consume more power.

\*10X average



Both types of screen work in the same way. Images are created by turning individual dots on the screen on or off in various combinations. These dots are called pixels.

The LCD panel in your computer displays up to 1024 horizontal and 768 vertical pixels.

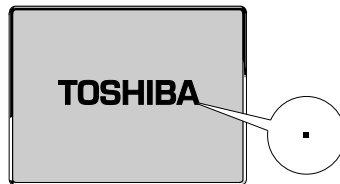

*A pixel on the display*

A pixel is the smallest element on the screen. On a color display, each pixel is made up of three subpixels: one red, one green and one blue (RGB). Each subpixel may be either on or off. Mixing on and off subpixels is like blending the primary colors to create other colors.

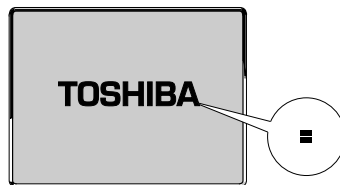

*A pel formed by several pixels*

The smallest element that your programs can control is called a pel. Pels are arranged on the screen in a grid-like fashion. Depending on the video mode a program selects, a pel may be a single pixel or several pixels.

The pel size determines the clarity of the image—called screen resolution. Larger individual pels reduce the total number of available pels, resulting in lower resolution. Smaller pels increase the number of pels that can fit on the screen, resulting in higher resolution and a clearer image.

## Displaying Colors

The pel size also determines how many colors the display can produce. By combining pixels of different colors within a pel, the display can produce many more colors than are available within a single pixel. Therefore, larger individual pels increase the number of colors available to the display.

## Understanding Video Modes

Video modes are sets of industry-standard rules about resolution and the maximum number of distinct colors that can be displayed simultaneously on the screen. Programs that adhere to the rules of a video mode will run on any system that supports that mode.

Most display adapters provide several video modes. The computer's SVGA-compatible display adapter supports all VGA modes and some SVGA modes.

The video mode required by a program depends on:

- ❖ Whether the program displays graphics or text.
- ❖ The resolution required for the text or graphics.
- ❖ The number of colors used.
- ❖ The font size (in pixels) of the text.

Based on these requirements, computers recognize two categories of video modes: graphics modes and text modes.

In a graphics mode, programs can turn on and off individual pels to display a variety of images. The computer controls every pel on the screen individually. This provides maximum display flexibility while somewhat reducing the speed at which the display produces images.

An image produced this way could be a drawing or picture, like a pie chart, graph or photograph. It could also be an icon or a variation on a text character, like italics or bold type.

Windows 95 and Windows programs use graphics modes.

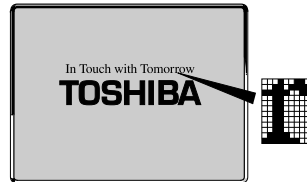

*Character cell in a text mode*

In a text mode, a character cell is the smallest element a program can control. A character cell is a grid of pels. All cells are the same size. Each cell displays a single letter or symbol. Character cells are arranged in rows and columns. In a text mode, only characters from a predefined set are available. If your program uses a text mode, refer to the program's documentation for a list of available characters.

## What About the Batteries?

A battery converts chemical energy into electrical energy. Rechargeable batteries, like those in your computer, can take an electrical current and store it as chemical energy for later use.

In addition to the main battery that powers your system when you're away from an AC outlet, your computer has two other batteries:

- ❖ The backup battery supports Resume Mode. When you turn the computer off in Resume Mode, a special memory powered by the backup battery keeps track of everything for the next time you turn the computer on. The backup battery gets its charge from the main battery. It maintains its charge for up to eight hours after the main battery discharges.
- ❖ The RTC (real-time clock) battery powers the RTC memory which stores the computer's configuration information. When you make changes in TSETUP, the MaxTime Control Panel or the Toshiba System Control Panel, this memory keeps track of those settings. The RTC battery also operates the computer's internal clock. Like the backup battery, the RTC battery gets its charge from the main battery. It maintains its charge for up to one month.

Be careful not to overcharge the battery. If you know your main battery is fully charged, use it rather than connecting to an AC power source.

Batteries gradually discharge when not used. If your main battery has been idle for several days, you will need to charge it again before you use it.

Don't leave your battery packs dormant for long periods. Even if you use AC power most of the time, use the main battery periodically to keep it fresh.

## Power Management

Power management is the process of conserving power when applications or hardware devices are idle. This is particularly important when you are using the battery to power your computer.

For example, when you are compiling a report, you are likely to pause frequently while you consult documents and collect your thoughts. If your computer shuts off power to components such as the processor and disc drives while you are not actively using them, the battery charge will last much longer.

Your Tecra 740CDT computer comes with a range of power saving options already set up. If you want to change any of the settings to suit your working pattern, refer to "The MaxTime Control Panel" on page 409, or "TSETUP" on page 427.

---

## What Really Happens When You Turn the Computer On?

When you press the power button, the following occurs:

**1 The computer's BIOS (Basic Input/Output System) loads a bootstrap program.**

This program, named from the expression “pull yourself up by your bootstraps,” checks and displays the amount of memory in the system before proceeding.

**2 The bootstrap program attempts to load Windows 95.**

It looks first for a diskette in the diskette drive and then at the hard disk. If a diskette without the necessary start-up files is in the drive, the bootstrap program displays an error message.



NOTE

*If you've changed the Boot Priority option in TSETUP, the computer will check the hard disk before the diskette drive.*

---

**3 As Windows 95 loads, it configures the system.**

**4 Windows 95 loads the desktop.**

# If Something Goes Wrong

---

Some problems you may encounter when using the Tecra 740CDT computer are relatively easy to identify and solve. Others may require help from your dealer or the manufacturer of a software program.

This chapter aims to help you solve many problems yourself without needing additional help. It covers the problems you are most likely to encounter.

Read the section headings on the opposite page, then turn to the section that covers the type of problem you are having. Read the section and see if it describes your problem. If so, follow the steps for solving it.

If all else fails, contact Toshiba. You will find information on Toshiba's support services at the end of this chapter.

## Problems that are Easy to Fix

The more you work with your computer, the more likely you are to encounter one or more of the following problems. Don't panic! You can solve them relatively easily.

### Software Problems

#### **Your program stops responding.**

If you are working with a program that suddenly freezes all operations, the program has probably stopped responding. Don't worry. You can exit the failed program without shutting down Windows 95 or closing other programs.

To close a program that has stopped responding, follow these steps:

**1 Type Ctrl + Alt + Del once.**

Windows 95 displays the Close Program dialog box. The box lists all the programs and processes currently in operation. If a program has stopped responding, the words "not responding" appear beside its name in the list.

**2 Select the program you want to close, then click End Task.**

Closing the failed program should allow you to continue working. If it does not, continue with step 3.

**3 Close the remaining programs by clicking End Task.**

**4 Click Shut Down.**

Windows 95 displays the Shut Down Windows dialog box.

---

**5 Select Restart the computer, then click Yes.**

Windows 95 shuts down and restarts the system, thus restoring operations.



NOTE

*Typing Ctrl + Alt + Del twice to restart your computer is not recommended. By closing all open programs prior to shutting down Windows 95 you ensure that all data is saved.*

---

**Your program performs an illegal operation.**

If you receive the message, “Your program has performed an illegal operation,” you should record the details of the message and consult the software manufacturer.

To record the details:

**1 Click the Details button and select the text Windows 95 displays.**

The Details button displays information that the software manufacturer needs to help you solve your problem.

**2 Press Ctrl + c to copy the text to the clipboard.**

**3 Open Notepad (click the Start button, point to Programs, then point to Accessories and click Notepad).**

**4 Press Ctrl + v to paste the details into Notepad.**

**5 Add a paragraph break and type some notes describing what you were doing when you received the message.**

**6 Save the file and refer to it when you contact the software manufacturer.**

**You receive a “Non-System Disk” error message.**

A disk is in the diskette drive while the computer is starting Windows 95. Remove the diskette from the drive and press any key to continue.



**You open a program that immediately stops responding.**

If CPU sleep mode is on (enabled), it may stop a program from responding. Close the program you are trying to open and turn off (disable) sleep mode. Then, try to run the program again.

To close the program:

- 1 Type Ctrl + Alt + Del.**

The Close Program dialog box appears, listing all the programs and processes currently in operation. If the program has stopped responding, the words “not responding” appear beside it.

- 2 Click End Task, then click Cancel.**

You disable sleep mode in the MaxTime Control Panel or TSETUP. Continue with these steps to disable sleep mode using the MaxTime Control Panel:

- 3 Click Start, then point to Settings.**

- 4 Click Control Panel.**

Windows 95 opens the Control Panel.

- 5 Double-click the MaxTime icon.**

The MaxTime Control Panel opens with the Power Settings tab on top.

- 6 Select Custom Settings from the Power Usage Mode dropdown list box.**

- 7 Click Modify Custom Settings.**

The MaxTime Control Panel displays the Modify Custom Settings dialog box.

- 8 Move the Sleep Mode slider to Disabled.**

- 9 Click OK.**

- 10 Click OK to exit the MaxTime Control Panel.**

If the problem continues, contact the manufacturer of the program.

**You cannot load a software package.**

The diskette or CD-ROM may be damaged, or the program may be corrupted. Try loading another copy of the software.

**An error message appears while you are using a program.**

Refer to the program's documentation. Typically this will include a trouble-shooting section or a summary of error messages.

## Hardware Problems

If your computer or one of the devices connected to it isn't working properly, try this procedure first:

- 1 Turn off the computer and any peripheral devices connected to it. This includes your printer and any other external devices.**
- 2 If you are not in your home or office, check that the wall outlets are working by plugging in another appliance such as a lamp.**
- 3 Check that the power cords are firmly plugged in.**
- 4 Check that all cables connecting peripheral devices to the computer are correctly and firmly attached. Loose cables can cause signal errors.**
- 5 Turn the peripheral devices on.**
- 6 Turn the computer on.**
- 7 If you are running the computer on battery power, check that the battery charge isn't low.**

If the equipment still isn't working properly, refer to the device-specific sections of this chapter.

## Problems When You Turn the Computer On

These problems may occur when you turn the power on.

### **The computer won't start.**

If you did not follow the steps in the previous section, make sure you attached the power cord properly or installed a charged battery.

Press and hold the power button for a few seconds.

### **The computer starts, but then shuts down and the power indicator glows orange and blinks.**

The computer has become too hot, so it has automatically entered Resume mode and shut down. Leave the computer turned off until its interior has reached room temperature (88F/30C or less).

### **The computer starts but, when you press a key on the keyboard or touch the AccuPoint, nothing happens.**

You are probably in Resume Mode and have a software or resource conflict. When this happens, turning the power on returns you to the problem instead of restarting the system. To clear the condition, press Ctrl + Alt + Del or press the reset button.

Clearing the condition may get you running by disabling Resume Mode, but it won't solve a resource conflict. Read the documentation that came with the conflicting device and "Resolving a Hardware Conflict" on page 335.

### **You press the power button and hear the system start, but you receive a hard disk drive (HDD) error message.**

There is a problem starting Windows 95 from your hard disk. Follow these steps:

- 1 Insert a Toshiba Companion Diskette into the diskette drive.**

---

**2 Restart your computer and press F10 when the system starts.**

Pressing F10 changes the Boot Priority option setting in TSETUP. This command instructs the computer to start from the diskette drive.

The message “Welcome to Toshiba Companion Diskette” displays on your screen.

**3 Press Enter.**

The Toshiba Companion Diskette Main Menu displays a list of options.

**4 Choose “Exit to DOS,” and press Enter.**

The MS-DOS prompt, a:> appears.

**5 Type sys c:, then press Enter.**

The computer processes the command and displays the message “system transferred” when complete.

**6 Remove the diskette from the diskette drive.**

**7 Restart your computer.**

Your system should start Windows 95 from the hard drive. If you receive another error message, there is a problem with Windows 95 on your hard disk. To fix the problem, run Windows 95 setup by following these steps:

**1 Insert a startup diskette into the diskette drive.**



*A startup diskette is one containing the files needed to start the computer and load Windows 95. You created a startup diskette when you ran the Microsoft Create System Disks program.*

---

**2 Restart your computer and press F10 when the system starts.**

Pressing F10 changes the Boot Priority option setting in TSETUP. This command instructs the computer to start from the diskette drive.

The message “Starting Windows 95” displays, followed by the MS-DOS prompt, a:>.

**3 Remove the startup diskette from the diskette drive and insert Windows 95 disk #1.**

**4 Type setup, then press Enter.**

If your hard disk is intact, Setup installs Windows 95 again without removing information you have saved on the hard disk. Follow the messages that appear on your screen.

If you receive another error message, contact Toshiba technical support. See “If You Need Further Assistance” on page 359.

**The computer is not accessing the hard disk or the diskette drive.**

If the Start Up Sequence option in the Toshiba System Control Panel is set to “Built-in hard disk first, then floppy disk,” or the Boot Priority option in TSETUP is set to HDD→FDD and you have a hard disk problem you won’t be able to start the computer. Insert a system diskette into the diskette drive and press F10 while you turn the power on.

**The computer displays the WARNING RESUME FAILURE message.**

The backup battery is discharged. To charge the backup battery, plug the computer in and turn it on for about seven hours.

---

**The computer displays the Non-System disk or disk error message.**

Make sure there is no diskette in the diskette drive. If there is one, remove it and press any key to continue. If pressing any key does not work, press Ctrl + Alt + Del or press the reset button to restart the computer.

The hard disk drive may not be seated properly. Remove the hard drive, then re-insert it, making sure the drive is fully seated in the slot. Refer to “Replacing the Hard Disk Drive” on page 118 for hard disk drive removal and installation instructions.

If the problem persists, try restarting the computer with the Toshiba Companion Disk or another reliable system disk in the diskette drive.

## Windows 95 Isn't Working

Once you are familiar with the desktop and used to the way Windows 95 responds to your work routine, you can easily detect if Windows 95 isn't working correctly. For example:

- ❖ Windows 95 fails to start after the Starting Windows 95 message appears.
- ❖ Windows 95 takes a long time to start.
- ❖ Windows 95 does not follow its normal routine.
- ❖ The display on your screen looks different.

Unless a hardware device has failed, these problems usually occur when you change the system configuration, add a device, install a new program, or do something that changes the system's established routine.

If you experience any of these problems, use the startup options in the Windows 95 Startup Menu to fix them.

## Using Startup Options to Fix Problems

If Windows 95 fails to start properly, you may have to change your system's configuration or verify the startup procedure to fix the problem. To do this, use the startup options in the Windows 95 Startup menu. This section describes each startup option and when to use the procedure.

To open the Windows 95 Startup menu:

- 1 Restart your computer.**
- 2 Press F8 when your computer starts.**

The Windows 95 Startup Menu displays the following options:

- ❖ Normal
- ❖ Logged (BOOTLOG.TXT)
- ❖ Safe Mode
- ❖ Step-by-Step Confirmation
- ❖ Command Prompt Only
- ❖ Safe Mode Command Prompt Only



*If your computer is connected to a network, the Startup Menu may display different versions of Safe Mode.*

---

### Normal

Selecting Normal starts Windows 95 under normal conditions. Start the computer in Normal mode when there are no apparent problems with the system.

### Logged (BOOTLOG.TXT)

Selecting Logged starts Windows 95 under normal conditions and creates a hidden startup log file named C:\BOOTLOG.TXT. This records every step of the system's startup process.

---

You or a qualified Windows 95 expert can use this log file to check the loading and initializing of Windows 95 device drivers. A device driver is a file that contains information to help the system BIOS control the operations of devices connected to the system.

## Safe Mode

Selecting Safe Mode bypasses basic startup files and starts Windows 95 enabling only the mouse, keyboard, and standard VGA drivers.

Running Safe Mode allows you to undo any changes you made to the system configuration that may have caused Windows 95 or a device to fail. For example, if you choose a resolution that is not supported by the display, Windows 95 will have a problem starting correctly. Safe Mode bypasses the setting and allows you to change the resolution to one supported by the display. Once you have done this, Windows 95 will start correctly.

Other problems may involve a device driver. See “Windows 95 Can Help You” on page 335. to fix the problem.



*Windows 95 automatically starts in Safe Mode if it detects that system startup failed or the Windows 95 Registry is corrupted.*

---

## Step by Step Confirmation

When you turn your computer on, Windows 95 processes the startup directory. With Step by Step Confirmation, the system asks you to confirm each line of the startup process as it appears on the screen. Use this option when:

- ❖ The startup process fails while loading the startup files.
- ❖ You need to verify all drivers are being loaded.
- ❖ You need to temporarily disable a specific driver(s).
- ❖ You need to check for errors in the startup files.



Windows 95 uses a new system file, IO.SYS, which contains all the information needed to start the computer. Although your computer does not need CONFIG.SYS and AUTOEXEC.BAT to start, it does process these files to support backward compatibility with some applications and device drivers. The same holds true for SYSTEM.INI and WIN.INI. Most of the information contained in these files is now stored in the Windows 95 Registry. However, they are still processed during startup. BOOTLOG.TXT file contains a record of all the components and drivers being loaded during startup and the status of each. When you select Step by Step Confirmation, you can view all these files in the startup directory line by line to troubleshoot a problem.

### **Command Prompt Only**

Selecting Command Prompt Only starts the basic operating system with all the startup files and device drivers.

Use this option when you want to run MS-DOS or Windows 95 commands. This option is for advanced users who are familiar with MS-DOS and know what these commands do.

### **Safe Mode Command Prompt Only**

Selecting Safe Mode Command Prompt Only bypasses the system startup files and displays the command prompt.

Use this option under the following conditions:

- ❖ When Windows 95 fails to start even in Safe Mode.
- ❖ When you want to run MS-DOS commands such as edit to make changes to your startup files.
- ❖ When you want to avoid loading HIMEM.SYS (extended memory manager), or IFSHLP.SYS (file system manager).

## Windows 95 Can Help You

If Windows 95 has started properly, but you still have a problem using your computer, Windows 95 Help can assist you in troubleshooting the problem.

To open the Windows 95 troubleshooting aid, follow these steps:

**1 Click the Start button and click Help.**

The Help Topics: Windows Help dialog box appears.

**2 Click the Contents tab and select Troubleshooting.**

**3 Double-click a problem you would like help with, and follow the steps.**

## Resolving a Hardware Conflict

If you receive an error message telling you there is a device driver conflict or a general hardware problem, try using Windows Help to troubleshoot the problem first.

**1 From the Windows Help menu, click the Contents tab and select Troubleshooting.**

**2 Click “If you have a hardware conflict” and follow the steps.**

If there is still a problem, Windows 95 should display a message that explains what the conflict is. If this happens, you may need to solve the problem on your own.

## A Plan of Action

The smooth operation of the system depends on the interaction of all devices, programs and features. If the system or one of its attached devices isn't working, resolving the problem can be time consuming and frustrating.

## 336 **If Something Goes Wrong** *Resolving a Hardware Conflict*

---

The recommended procedure for getting multiple devices to work together is to add and configure one device at a time. After you add each device, test it to make sure it and all previously connected devices work.

The device most recently connected to the system is the one most likely to be causing a hardware conflict.



NOTE

*A word to the wise: if you get too tired, take a break. Having a meal or a good night's sleep refreshes you mentally as well as physically. Talking the problem over with a friend can help too.*

---

### **Resolving Hardware Conflicts on Your Own**

Computer components need resources to accomplish a task. A device, such as a CD-ROM drive or a modem, needs a channel to the computer's Central Processing Unit (CPU). It also needs a direct channel to the computer's memory to store information as it works. These channels of communication are commonly referred to as system resources.

#### **Interrupt Request Channel**

The channel to the CPU is called an Interrupt ReQuest (IRQ) because it interrupts what the processor is doing and requests some of the processor's time. If two or more devices use the same IRQ, the processor doesn't know which device is asking for attention. This causes a problem.

## Direct Memory Address

Similarly, the data required by the device is stored in a specific place or address in memory called the Direct Memory Address (DMA). The DMA provides a dedicated channel for adapter cards to bypass the micro processor and directly access memory. If two or more devices use the same DMA, the data required by one device overwrites the data required by the other. If this occurs, you have a hardware conflict.

## Plug and Play

With Plug and Play and Windows 95, avoiding hardware conflicts is easy. Plug and Play is a computer standard that helps the system BIOS (basic input/output system) and Windows 95 to automatically assign system resources to Plug and Play-compliant devices. In theory, if every device connected to the computer is Plug and Play-compliant, no two devices will compete for the same system resources. You simply plug in the device and turn your computer on. Windows 95 automatically configures your system to accommodate the new device.

However, if you install an older (legacy) device that Windows 95 cannot detect, Windows 95 may have difficulty assigning system resources to it. As a result, a hardware conflict can occur. To find out what resources Windows 95 has assigned to the legacy device, see “Checking Device Properties” on page 339. If Windows 95 is unable to provide the information you need, the pre-assigned settings for IRQs, DMAs and I/O assignments are listed in “System Resources” on page 479 for your reference.

## Resolving Conflicts

There are three things you can do to resolve hardware conflicts.

- ❖ Disable the device.

For an older device, remove it from the computer. For a Plug and Play device, see “Fixing a Problem with Device Manager” on page 299.

- ❖ Disable another system component and use its resources for the new device.

See “Fixing a Problem with Device Manager” on page 338.

- ❖ Reconfigure the device so its requirements do not conflict.

Refer to the device’s documentation for instructions about changing settings on the device.

## Fixing a Problem with Device Manager

Device Manager provides a way to check and change the configuration of a device.



*Changing the default settings using Device Manager can cause other conflicts that make one or more devices unusable. Device Manager is a configuration tool for advanced users who understand configuration parameters and the ramifications of changing them.*

---

## Disabling a Device in Windows 95

To disable a device, follow these steps:

- 1 Click the My Computer icon with the secondary button, then click Properties.**

The System Properties dialog box appears.

- 2 Click the Device Manager tab.**

**3 Double-click the device type to display the device installed.**

**4 Select the device and click Properties.**

A dialog box displays the device's properties.

**5 In the Device usage section of the dialog box, clear the check box next to the current configuration.**

**6 Click OK.**

### Checking Device Properties

Device Manager provides a way to view the properties of a device. Properties include the name of the manufacturer, the type of device, the drivers installed, and the system resources assigned to the device. To check a device's properties follow these steps:

**1 Click the Start button and point to Settings, then click on Control Panel.**

**2 Double-click the System icon.**

Windows 95 displays the System Properties dialog box.

**3 Click the Device Manager tab.**

**4 Double-click the device type.**

**5 To view the properties, double-click the device.**

Windows 95 displays the Device Properties dialog box, which provides various tabs to choose from. Some of the common ones are:

- ❖ The General tab provides basic information about the device.
- ❖ The Resources tab lists the resources assigned to the device. If you have a device conflict, it is shown in the Conflicting device list.
- ❖ The Drivers tab displays the drivers being used by the device.

For further information about Device Manager, refer to Windows 95 on-line help.

## Fixing Device Related Problems

If you don't have a hardware conflict, but you think your problem could be related to one of your computer's devices, the first thing to do is run a system verification test. A system verification test confirms that the factory-installed devices connected to the computer are working. This includes testing the memory, hard disk, disk drive, etc.

Then read the relevant parts of this section which describes problems and solutions related to specific devices. For more extensive testing see "The Diagnostic Test" on page 449.

### Running the System Verification Test

To verify the system when Resume mode is off, follow these steps:

- 1 Turn the computer off.**
- 2 Hold down the spacebar while you press the power button.**

To verify the system when Resume Mode is on, hold down the spacebar while you press the reset button.

System verification displays the following message for a few seconds as the computer tests memory:

```
(C) Copyright 19>.xx Toshiba Corp. All rights reserved.  
MEMORY TEST xxxxB
```

### Successful Test Results

If the test verifies that the factory-installed components connected to the system are functional, the computer sounds a short beep then starts the operating system.

## Unsuccessful Test Results

If the system verification test fails, the computer does one of the following:

- ❖ Stops updating the memory counter and does not proceed to display information or messages.
- ❖ Sounds a beep but displays no new messages.
- ❖ Displays random characters and does not function normally.
- ❖ Displays an error message.

Verify the system again. Before you do so, turn the computer off and make sure all optional devices are connected properly and turned on. Then, turn the computer on and run the test again. If the test fails a second time, you have demonstrated that you can reproduce the problem and it's time to contact a trained technician.

## Other Circumstances

The computer normally beeps at the conclusion of a successful system verification. If the system speaker is set to Disabled, this beep will not occur.

If the speaker is turned on (enabled) and the system verification completes but you don't hear a beep, the speaker may be faulty. Though this does not affect the computer's operation, you may wish to contact your dealer and have it repaired.

If the system verification is successful but the operating system won't load, refer to "Problems When You Turn the Computer On" on page 328. If all seems correct, treat this as a hardware error and contact your dealer.



## Where Do I Go from Here?

If you determined that you have a problem with a specific device, the following sections list problems related to specific devices and offer some solutions.

Memory Card Problems .....	342
Power and the Batteries .....	343
The Keyboard .....	344
The AccuPoint .....	345
The Display .....	346
The Disk Drives .....	347
The Internal Modem .....	349
CD-ROM Drives .....	350
Sound System .....	351
Optional Devices .....	352
PC Cards .....	352
Printers .....	357

## Memory Card Problems

Incorrectly connected or faulty memory cards may cause errors that seem to be device-related. So it's worthwhile checking for these first:

**1 Click Start, then click Shut Down.**

Windows 95 displays the Shut Down Windows dialog box.

**2 Click the button next to Shut down the computer, then click Yes.**

Windows 95 shuts down and turns the computer off automatically.

**3 Remove the memory card.**

**4 Reinstall the memory card, following the instructions in “Adding Memory (Optional)” on page 19 and making sure it's seated properly.**

**5 Replace the memory expansion slot cover.**

**6 Check for the error again.**

**7 If the error reoccurs, remove the memory card entirely and check for the error again.**

If removing the memory card eliminates the error, the memory card may be faulty. If the error reoccurs without the memory card installed, the error is not caused by the memory card.

## Power and the Batteries

Your computer receives its power through the built-in power supply and power cord or from the system batteries (main battery, real-time clock (RTC) battery and backup battery). Power problems are interrelated. For example, a faulty power cord will neither power the computer nor recharge the batteries.

Here are some typical problems and how to solve them:

**The AC power light doesn't come on when you plug in the AC adapter.**

Make sure the AC adapter is firmly plugged into both the power cord and the computer, and that the power cord is plugged into a working wall outlet.

If the AC power light still doesn't come on, check that the wall outlet is working properly by plugging in a lamp or other appliance.

**The power cord and AC adapter work correctly, but the battery won't charge.**

The main battery may not be inserted correctly in the computer. Turn off the computer, remove the battery and confirm that its contacts are clean. If they are dirty, clean the contacts with a soft, dry cloth and replace the battery.

The battery may be too hot or too cold to charge properly. Its temperature needs to be in the range 50-88F (10-30C). If you think this is the probable cause, let the battery reach room temperature and try again.

If the battery has completely discharged, it will not begin charging immediately. Leave the AC adapter connected, wait 20 minutes and see whether the battery is charging.

If the battery icon is glowing after 20 minutes, leave the computer to continue charging the battery for at least another 20 minutes before you turn the computer on.

If the battery icon doesn't glow after 20 minutes, the battery may have reached the end of its useful life. Try replacing it.

### **The battery appears not to power the computer for as long as it usually does.**

If you frequently recharge a partially charged battery, it may not charge fully. Let the battery discharge completely, then try charging it again.

Check the power-saving features in the MaxTime Control Panel or TSETUP. Have you added a device, such as a PC Card or memory module, that takes its power from the battery? Is your software using the hard disk more? Is the display power set to turn off automatically? Is the battery fully charged to begin with? All these conditions affect how long the charge lasts.

For more information on maximizing battery power, refer to "Looking After Your Battery" on page 160 and "Conserving Power" on page 154.

## **The Keyboard**

If, when you type, strange things happen or nothing happens, the problem may be related to the keyboard itself.

### **The keyboard produces unexpected characters.**

A keypad overlay may be on. If the numeric keypad or cursor control light is on, press Fn + F10 to turn off the cursor control light or Fn + F11 to turn off the numeric keypad light.

If the problem occurs when both the keypad overlays are off, make sure the software you are using is not remapping the keyboard. Refer to the software's documentation and check that the program does not assign different meanings to any of the keys.

**You've connected an external keyboard and Windows 95 displays one or more keyboard error messages.**

The keyboard you connected may be defective or incompatible with the computer. Try using a different make of keyboard.

**Nothing happens when you press the keys on the external keyboard.**

You may have plugged the external PS/2 keyboard in while the computer was turned on. Click Start, Shut Down and Restart the computer using the AccuPoint on the internal keyboard. The computer will restart and recognize the device.

**The keyboard locks and the computer will not restart.**

Make sure the power is on and press the reset button.

## The AccuPoint

Some of the keyboard conditions listed above may also affect the AccuPoint.

**Your finger easily slides off the AccuPoint.**

The AccuPoint cap may be greasy. Remove the cap and clean it with a cotton swab dipped in rubbing alcohol.

Or the cap may have become worn. Replace the cap with one of the spares that came with your computer. Follow these steps:

**1 Remove the AccuPoint cap by grasping it firmly and pulling it straight up.**

The AccuPoint spindle is now visible.

**2 Position the new cap on the spindle and press it into place.**

## The Display

Here are some typical display problems and their solutions:

### **The display is blank.**

Display Auto Off may have gone into effect. Press any key to activate the screen.

You may have activated the instant security feature by pressing Fn + F1. Enter your password if you have registered one, or press Enter to return to work.

If you are using the built-in screen, try changing the display priority to make sure it is not set for an external monitor. To do this, press Fn + F5.

If you are using an external monitor:

- ❖ Check that the monitor is turned on
- ❖ Check that the monitor's power cord is firmly plugged in to a working power outlet
- ❖ Check that the cable connecting the external monitor to the computer is firmly attached
- ❖ Try adjusting the contrast and brightness controls on the external monitor
- ❖ Press Fn + F5 to make sure that the display priority is not set for the built-in LCD screen

### **The display doesn't look right.**

See "Changing the Display Mode" on page 308 to adjust your screen resolution or color settings.

### **The built-in screen flickers.**

Some flickering is a normal result of the way the screen produces colors. To reduce the amount of flickering, try using fewer colors.

---

**Windows 95 displays a message that there is a problem with your display settings and that the adapter type is incorrect or the current settings don't work with your hardware.**

Reduce the size of the color palette to one that is supported by the computer's internal display. See "Changing the Display Mode" on page 308 for instructions.

**The display is set to Simultaneous and the external display device doesn't work.**

Make sure the device is capable of displaying at resolutions of 1024 x 768 or higher. Low-resolution devices will only work in Internal/External mode.

## The Disk Drives

Problems with the hard disk or with a diskette drive usually show up as an inability to access the disk or as sector errors. Sometimes a disk problem may cause one or more files to appear to have garbage in them. Typical disk problems are:

**You are having trouble accessing a disk, or some of the data appears to be missing.**

Make sure you're identifying the drive by its correct name (A or C).

Run ScanDisk, which analyzes the directories, files and File Allocation Table (FAT) on the disk and repairs any damage it finds. To run ScanDisk, follow these steps:

- 1 Click Start, then point to Programs.**
- 2 Point to Accessories, then point to System Tools.**
- 3 Click ScanDisk.**

Windows 95 opens the ScanDisk window.

**Your hard disk seems very slow.**

If you have been using your computer for some time, your files may have become fragmented. Run Disk Defragmenter. Click Start/Programs/Accessories/System Tools/Disk Defragmenter.

**Your data files are damaged or corrupted.**

Refer to your software documentation for file recovery procedures. Many software packages automatically create backup files.

You may also be able to recover lost data by using utility software, which is available from your dealer.

**Some programs run correctly but others do not.**

This is probably a configuration problem. Where a program doesn't run properly, refer to its documentation and check that the hardware configuration meets its needs.

**A diskette won't go into the diskette drive.**

You may already have a diskette in the drive. Make sure the drive is empty.

You may be inserting the diskette improperly. Hold the label of the diskette with the hub side facing down, and insert it so the metal head window cover goes into the drive first.

The metal cover or loose labels may be obstructing the path into the drive. Carefully inspect the diskette. If the metal cover is loose, replace the diskette. If the label is loose, replace the label and try inserting the diskette again.

**The computer displays the Non-system disk or disk error message.**

If you're starting the computer from the hard disk, make sure there's no diskette in the diskette drive.

If you're starting the computer from a diskette, the diskette in the drive doesn't have the files necessary to start the computer. Replace it with a bootable diskette.

---

**A diskette won't format properly.**

Make sure you've chosen the correct disk capacity in the Format dialog box. You can't format double-density diskettes as high-density diskettes and vice versa.

Try using a different diskette. If the computer completes the formatting of the new diskette, run ScanDisk to check the new diskette. If the drive formats properly and ScanDisk doesn't report any errors during the test, the problem is probably a faulty diskette.

**The drive can't read a diskette.**

Try another diskette. If you can access the second diskette, the first diskette (not the disk drive) is probably causing the problem. Run ScanDisk on the faulty diskette.

If you're using the diskette drive externally, unplug the cable and plug it back in to make sure the connection between the diskette drive cable and the port is secure.

If the problem occurs with each diskette you attempt to access, run the diagnostic test. Refer to "The Diagnostic Test" on page 449.

## The Internal Modem

This section lists common modem problems.

**The modem dials the line but doesn't connect, or cannot maintain the connection.**

You may be connected to a noisy telephone line. To check this, connect an ordinary telephone to the telephone line and try placing a phone call. If you hear an unusual amount of noise or static, try connecting the modem to a different telephone line or connecting at a later time.

There may be an improper setting in the communications software. Refer to the communications software documentation to customize the modem settings.



**The modem won't receive or transmit properly.**

Make sure the RJ-11 cable (the one that goes from the modem to the telephone line) is firmly connected to the modem's RJ-11 jack and the telephone line socket.

Check the serial port settings to make sure the hardware and software are referring to the same COM port.

Check the communications parameters (baud rate, parity, data length and stop bits) specified in the communications program.

**The modem is on, configured properly and still won't transmit or receive data.**

Make sure the line has a dial tone. Connect a telephone handset to the line to check this.

The other system may be busy or off-line.

## CD-ROM Drives

**You cannot access a CD in the drive.**

Make sure the drawer has closed properly. Press gently until it clicks into place.

Open the drawer and remove the CD. Make sure the drawer is clean. Any dirt or foreign object can interfere with the laser beam.

Examine the CD to see whether it is dirty. If necessary, wipe it with a clean cloth dipped in water or a neutral cleaner.

Replace the CD in the drawer. Make sure that the CD is lying flat, label side uppermost. Close the drawer carefully, making sure it has shut completely.

**You press the CD-ROM eject button, but the CD-ROM tray doesn't slide out.**

Make sure the computer is connected to a power source and turned on. The CD-ROM drive eject mechanism requires power to operate.

If you need to remove a compact disc and cannot turn the computer on (for example, if the battery is completely discharged), use a narrow object, such as a straightened paper clip to press the manual eject button. This button is in the small hole next to the CD-ROM eject button on the front of the computer.

**Some CDs run correctly but others do not.**

Check the type of CD you are using. The drive supports ISO 9660 and CD Plus data CDs, audio CDs and photo CDs.

If the problem is with a data CD, refer to the software's documentation and check that the hardware configuration meets the program's needs.

The color of the material used to make the CD can affect its reliability. Silver-colored CDs are the most reliable, followed by gold-colored CDs. Green-colored CDs are the least reliable.

**The CD will not come out of the drive when you click the eject button.**

Press the button on the CD-ROM drive itself.

## Sound System

**You don't hear any sound from the computer.**

Adjust the volume control.

If you are using an external microphone or speakers, check that they are securely connected to your computer.

In TSETUP, check that the sound function is enabled.

**The computer emits a loud, high-pitched noise.**

This is feedback between the microphone and the speakers. It occurs in any sound system when input from a microphone is fed to the speakers and the speaker volume is too loud. Adjust the volume control.

If you have changed the settings for the Record Monitor feature in the Recording Control Utility (default Off) or the Mute feature in the Mixer Utility (default Enabled) these may cause feedback. Revert to the default settings.

## Optional Devices

Optional devices can include a printer, PC Cards, an external monitor, or any other device you connect to your computer to expand its capabilities. This section begins with some general comments and continues with sections for specific devices.

For an external monitor, see “The Display” on page 346.

## PC Cards

PC Cards (PCMCIA-compatible) include many types of devices, such as a removable hard disk, additional memory, fax/modem or pager. The applications for these devices continue to grow as new products come onto the market almost daily.

Most PC Card problems occur during installation and setup of new cards. If you're having trouble getting one or more of these devices to work together, several sections in this chapter may apply.

Resource conflicts can cause problems when using PC Cards. Refer to “Resolving a Hardware Conflict” on page 335.

## Card Information Structure (CIS)

When you insert a PC Card into a slot, the computer attempts to determine the type of card and the resources it requires by reading its CIS. Sometimes the CIS contains enough information for you to use the card immediately. Other cards must be configured before you can use them.

Use the CardWorks software to configure the card.

Some card manufacturers use special software called enablers to support their cards. Enablers result in nonstandard configurations that can cause problems when installing another PC Card.

If Windows 95 doesn't have built-in drivers for your PC Card and the card didn't come with a Windows 95 driver, it may not work under Windows 95. Contact the manufacturer of the PC Card for information about operating the card under Windows 95.

### PC Card Checklist

- ❖ Make sure the card is inserted properly into the slot.  
Refer to "Little Cards that Do Big Things" on page 193 for how to insert PC Cards, and to the documentation that came with the PC Card.
- ❖ Make sure all cables are securely connected.
- ❖ Make sure the computer has only one version of Card and Socket Services loaded.
- ❖ Occasionally a defective PC Card slips through quality control. If another PCMCIA-equipped computer is available, try the card in that machine. If the card malfunctions again, it may be defective.

### Resolving PC Card Problems

Here are some common problems and their solutions:

**The slots appear to be dead. PC Cards that used to work no longer work.**

Follow these steps to view the PC Card status:

- 1 Click the My Computer icon with the secondary button, then click Properties.**

Windows 95 displays the System Properties dialog box.

- 2 Click the Device Manager tab.**

- 3 Double-click the device listed as your PC Card.**

Windows 95 displays your PC Card's Properties dialog box. This dialog box contains information about your PC Card configuration and status.

**The system doesn't seem to recognize my CardBus PC Card.**

Make sure the PC Card Controller Mode is set to 16-Bit/CardBus. To check the PC Card Controller Mode, follow these steps:

**1 Click Start, then point to Settings.**

**2 Click Control Panel.**

Windows 95 opens the Control Panel.

**3 Double-click the Toshiba System icon.**

The Toshiba System Control Panel opens.

**4 Click the Miscellaneous tab to bring it to the front.**

**5 In the PC Card Controller Mode section, select 16-Bit/ CardBus.**

**6 Click OK to exit the Toshiba System Control Panel.**

The system displays a Toshiba System Settings Change dialog box that prompts you to restart your computer.

**7 Click Yes.**

The system shuts down and restarts.

**I've inserted my Zoomed Video PC Card and installed the Zoomed Video software, but I can't play MPEG files.**

Make sure the PC Card Controller Mode is set to PCIC. To check the PC Card Controller Mode, follow these steps:

**1 Click Start, then point to Settings.**

**2 Click Control Panel.**

Windows 95 opens the Control Panel.

**3 Double-click the Toshiba System icon.**

The Toshiba System Control Panel opens.

**4 Click the Miscellaneous tab to bring it to the front.**

**5 In the PC Card Controller Mode section, select PCIC.**

**6 Click OK to exit the Toshiba System Control Panel.**

The system displays a Toshiba System Settings Change dialog box that prompts you to restart your computer.

**7 Click Yes.**

The system shuts down and restarts.

**The computer stops working (hangs) when you insert a PC Card.**

The problem may be caused by an I/O (input/output) conflict between the PCMCIA socket and another device in the system. Make sure each device has its own I/O base address.

Since all PC Cards share the same socket, each card is not required to have its own address.

**Hot swapping (removing one PC Card and inserting another without turning the computer off) fails.**

Follow this procedure each time you want to remove a PC Card:

- 1 Click the PC Card icon on the taskbar.**
- 2 Click Stop xxxx, where xxxx is the identifier for your PC Card.**

Windows 95 displays a message saying you may safely remove the card.

- 3 Remove the card from the slot.**

**The system does not recognize your PC Card or PCMCIA socket controller.**

This problem may be caused by a low backup battery.

Charge the backup battery by following these steps:

- 1 Make sure the computer isn't in Resume Mode.**
- 2 Turn the computer off.**
- 3 Connect the power cord and charge the battery to 100%.**
- 4 Keep the computer plugged in for about seven hours with the power turned off.**

The problem may also be caused by a conflict with any additional memory in your system.

If you have an extra memory module installed, make sure the computer isn't in Resume Mode, turn the computer off, and remove the card.

Windows 95 may not have built-in drivers for your PC Card. Follow these steps to install PC Card support:

**1 Click Start, then point to Settings.**

**2 Click Control Panel.**

Windows 95 opens the Control Panel.

**3 Double-click Add New Hardware.**

Windows 95 opens the Add New Hardware Wizard.

**4 Click Next.**

**5 Follow the instructions on the screen to install support for your PC Card or PCMCIA socket controller.**

**There is still a yellow exclamation point (!) over the PCMCIA controller icon in Device Manager.**

You've gone through the PCMCIA Wizard in Windows 95 as described in "Setting Up Your PC Card for Your Computer" on page 201, but the system still reports the controller with a yellow !.

Your computer may not be firmly attached to the optional NoteDock II Enhanced Port Replicator. To fix the problem:

**1 Click Start, then click Shut Down.**

Windows 95 displays the Shut Down Windows dialog box.

**2 Click the button next to Shut down the computer, then click Yes.**

Windows 95 shuts down and turns the computer off automatically.

**3 Lift the locking latch on the NoteDock II Enhanced Port Replicator.**

**4 Gently lift the computer and slide it off of the NoteDock II Enhanced Port Replicator.**

**5 Reconnect the computer and NoteDock, making sure to press them together firmly.**

Refer to “Connecting the Computer to the NoteDock II Enhanced Port Replicator” on page 253 for instructions.

**6 Turn the computer on and try setting up PC Card support again.**

**A PC Card error occurs.**

Reinsert the card to make sure it is properly connected.

If the card is attached to an external device, check that the connection is secure.

Refer to the card’s documentation which should contain a troubleshooting section.

## Printers

This section lists some of the most common printer problems.

**The printer doesn’t print.**

Check that the printer is connected to a working power outlet and is turned on.

Check that the printer has plenty of paper. Some printers won’t start printing when there are just two or three sheets of paper left in the tray.

Make sure the printer cable is firmly attached to both the computer and the printer.

If your printer is ECP- or IEEE 1284-compliant, make sure you have an IEEE 1284 printer cable.

Run the printer’s self test to check for any problem with the printer itself.

Make sure you installed the proper printer drivers, as shown in “Setting Up Windows 95 to Work with Your Printer” on page 94.



You may have connected the printer while the computer was turned on. Disable Resume Mode, turn off the computer, and turn off the printer. Turn the printer back on, make sure it's ready (on line), then turn the computer back on.

You may have selected an incorrect Printer Port Type setting. To change this option setting, refer to "The Toshiba System Control Panel" on page 417.

**The printer doesn't print what I see on the screen.**

Many programs display information on the screen differently from the way they print it. See if your program has a print preview mode. This mode lets you see your work exactly as it will print. Contact the software manufacturer for more information.

## Developing Good Computing Habits

Sometimes we're in such a hurry to use a computer that we fail to adequately prepare for the problems that may occur. This section suggests some good habits to develop so you are prepared if things go wrong.

**Save your work frequently.**

You can never predict when your computer will lock, forcing you to close a program and lose unsaved changes. Many software programs build in an automatic backup, but you shouldn't rely solely on this feature. Save your work! See "How to Save Your Work" on page 92 for instructions.

**On a regular basis, back up the information stored on your hard disk.**

Here are a few ways you can do this:

- ❖ Copy files to diskettes in Windows 95, following the steps in "How to Copy Something to a Diskette" on page 105 or "How to Back Up Your Work" on page 107.
- ❖ Connect a tape drive to the system and use specialized software to copy everything on the hard disk to a tape.

Some people use a combination of these methods, backing up all files to tape weekly and copying critical files to diskette on a daily basis.

If you've added your own software to your system, you should back up the software as well as the data. If something goes wrong that requires you to format your hard disk and start again, reloading all your software and data from a backup will save time.

**Read the manuals.**

It's very difficult to provide a fail-safe set of steps you can follow every time you experience a problem with the computer. Your ability to solve problems will improve as you learn about how the computer and its software work together.

Get familiar with all the manuals provided with your computer, as well as the manuals that come with the programs and devices you purchase.

Your local computer store or book store contains a variety of self-help books you can use to supplement the information in the manuals.

**If problem solving is taking a long time, take a break.**

If you've been fighting to solve a problem for a long period of time, you're probably frustrated by now. Stand up, take a deep breath and do something else - make some coffee, look out the window, phone a friend. Often, you can find a new solution to a problem just by stepping away from it for a few moments.

## If You Need Further Assistance

If you have followed the recommendations in this chapter and are still having problems, you may need additional technical assistance. This section contains the steps to take to ask for help.

## Before You Call

Since some problems may be related to the operating system or the program you're using, it's important to investigate other sources of assistance first. Try the following before contacting Toshiba:

- ❖ Review the troubleshooting information in your Windows 95 documentation.
- ❖ If the problem occurs while you are running a program, consult the program's documentation for troubleshooting suggestions. Contact the software company's technical support group for their assistance.
- ❖ Consult the dealer from whom you purchased your computer and/or program. Your dealer is your best source for current information.

For the number of a Toshiba dealer near you in the United States, call the Toshiba InTouch Center at 1-800-457-7777.

## Contacting Toshiba

If you still need help and suspect that the problem is hardware related, Toshiba offers a variety of resources to help you.

Start with the Automated Fax Service. Chances are you are not the only person to experience this problem. Toshiba has prepared useful information that can be faxed to you automatically. For instructions see "Toshiba's Automated Fax Service" on page 361.

Next, try one of Toshiba's on-line services. The Toshiba Forum can be accessed through CompuServe, and the Toshiba Bulletin Board Service (BBS) can be reached free of charge from any PC with a modem.

If you still can't find a solution to your problem, you can call Toshiba directly. See "Toshiba Voice Contact" on page 362 for details.

---

## Toshiba's Automated Fax Service

Toshiba's Automated Fax Service System (AUTOFAX) provides useful information about Toshiba computers and accessories. You select documents using your touch-tone telephone. Toshiba's AUTOFAX System sends the requested information to your fax machine. Follow these steps to activate the system:

- 1 Dial the Toshiba InTouch Center at (800) 457-7777.**
- 2 Follow the automated instructions provided by the system to access the AUTOFAX System.**



---

*When entering the area code for your fax number, do not include the "1" prefix.*

---

The AUTOFAX System automatically calls your fax number and sends the requested information. The process usually takes minutes, but load conditions can vary. So please allow up to 24 hours to receive the information.

If your fax machine telephone number is busy or otherwise unavailable, the system makes up to three attempts to complete a transaction.

## Toshiba's Bulletin Board Service

Toshiba's Bulletin Board Service (BBS) is available 24-hours a day, and is free of charge to anyone with a PC and a modem. From Toshiba's BBS, you can download files and obtain other useful information to keep your computer running at peak performance.

Be sure you set your modem to Toshiba's BBS protocol:

Data Bits: 8  
Parity: None  
Stop Bits: 1

You may use the following telephone number:

714-837-4408

## Accessing Toshiba On Line

You can reach Toshiba on CompuServe (CIS), or the Internet World Wide Web (WWW):

- ❖ On CompuServe, type go toshiba to access the Toshiba forum.  
Along with twenty or so dedicated “Team Toshiba” volunteers who are on line at all hours, Toshiba’s technical support staff provides interactive technical support in a “bulletin board” type of forum layout. The Toshiba forum is further augmented by a huge library of downloadable information files, product specifications, utilities, drivers, and software.
- ❖ Use any World Wide Web browser to access the World Wide Web, then type <http://www.toshiba.com/tais/csd/support/>

## Toshiba Voice Contact

To aid Toshiba, make sure you have:

- ❖ The computer and any optional devices related to the problem.
- ❖ The Microsoft Windows 95 diskettes, the Toshiba Companion disk and the rest of the master diskettes. You created Microsoft Windows 95 diskettes using Microsoft Create System Diskettes and created other diskettes using Master Disk Creator or purchased diskettes containing the Toshiba drivers/utilities directly from Toshiba.
- ❖ Name and version of the program involved in the problem along with its installation diskettes.
- ❖ Information about what you were doing when the problem occurred.
- ❖ Exact error messages and when they occurred.

In the United States, you can reach Toshiba PC Product Support at:

800-999-4273

From outside the United States, call Toshiba PC Product Support at:

714-859-4273

### Toshiba's Worldwide Offices

For additional help, contact one of these Toshiba offices:

#### **Argentina**

Smart, S.A.  
Mexico (Street) 630  
Buenos Aires, 1097  
Argentina

#### **Australia**

Toshiba (Australia) Pty. Limited  
84-92 Talavera Road  
North Ryde NSW  
2113 Sydney  
Australia

#### **Austria**

Toshiba Europe GmbH  
Geschäftsbereich  
Deutschland-Österreich  
Hammfelddamm 8  
D-41460 Neuss  
Austria

#### **Belgium**

Toshiba Information Systems  
(Belgium) S.A.N.V.  
rue Colonel Bourg- straat 123-125  
B1140 Brussels  
Belgium

#### **Brazil**

Sistema Operacional  
Rua Helena 170; 8 Andar  
V. Olimpia, CEP 04552-050  
Sao Paulo  
Brasil

#### **Canada**

Toshiba of Canada Ltd.  
191 McNabb Street  
Markham, Ontario  
L3R - 8H2  
Canada

**Czech Republic**

CHG Toshiba, spol. s.r.o.  
Sumavská 31  
612 64 Brno

**Finland**

Scribona System OY  
Sinimäentie 14  
02631 Espoo  
Finland

**Germany**

Toshiba Europe GmbH  
Geschäftsbereich  
Deutschland-Österreich  
Hammfelddamm 8  
D-41460 Neuss  
Germany

**Hungary**

Technotrade  
Irodatechnikai Kft  
Öv u. 185  
1147 Budapest  
Hungary

**Ireland**

Same as United Kingdom

**Denmark**

Scribona Denmark AS  
Naverland 27  
DK2600 Glostrup  
Denmark

**France**

Toshiba Systèmes (France) SA  
7, Rue Ampère  
92804 Puteaux Cédex  
France

**Greece**

Ideal Electronics S.A.I.  
103 Michalacopoulou St.  
115 27 Athens  
Greece

**Iceland**

HKH  
Skiopholti 50c  
105 Reykjavik  
Iceland

**Italy**

CELO S.p.A.  
Via Saronnese, 16  
1-20025 Legnano (MI)  
Italy

**Italy (continued)**

Computer 2000  
S.p.A.  
Via Gaggia, 4  
1-20139 Milano  
Italy

**Japan**

Toshiba Corporation  
International Operations-  
Personal Computers  
1-1, Shibaura 1-Chome  
Minato-Ku, Tokyo, 105  
Japan

**Mexico**

Toshiba de Mexico  
Paseo de la Reforma no. 30, 4-Piso  
Centro 06048 D.F.  
Mexico City  
Mexico

**The Netherlands**

Toshiba Information Systems  
Benelux B.V.  
Rivium Boulevard 41  
2909 LK, Capelle a/d Ijssel  
The Netherlands

**Norway**

Scribona Norge A/S  
Postboks 51/Kalbakken  
0901 Oslo 9  
Norway

**Italy (continued)**

Ingram Micro  
Via Roma, 74  
1-20060 Cassina de Pecchi (MI)  
Italy

**Luxembourg**

Same as Belgium

**Morocco**

C.B.I.  
22 Rue de Bethune  
Casablanca  
Morocco

**New Zealand**

Toshiba (New Zealand) Pty. Limited  
Level 4, 3 Ferncroft Street  
Grafton Auckland  
New Zealand

**Papua New Guinea**

Fujitsu (PNG) Pty. Ltd.  
P.O. Box 4952 Boroko  
NCD, Papua  
New Guinea



**Poland**

VIA Computer  
Poland Sp. zo.o.  
ul. Wilcza 35-41  
PL00-678  
Warszawa  
Poland

**Portugal (continued)**

NEXT DS Distribuicao e Servicos  
Quinta Grander de Alfragide  
Lote 36 B e C  
P-2700 Amadora  
Portugal

**Portugal (continued)**

HA Solucoes Informaticas Lda.  
CNAT - Centro National de Asisten-  
cia Tecnica  
Urb. Quinta Grande, Lote 6, Loja A  
Alfragide  
P-2700 Amadora  
Portugal

**Slovenia**

INEA  
Ljudljanska 80  
61230 Domzale  
Slovenia

**Sweden**

Scribona System AB  
Sundbybergsväegen 1  
171 27 Solna  
Sweden

**Portugal**

DLI Distribuicao  
Av. do Forte n.3  
Piso 4 (Ed Suecia II)  
P-2795 Linda-a-Velha  
Portugal

**Portugal (continued)**

PERCOM Lda.  
Rua Prof. Vitorino Nemesio 189A  
P-2765 Estoril  
Portugal

**Slovakia**

HTC s.r.o.  
Toshiba PC  
Kukucinova 26  
831 03 Bratislava  
Slovakia

**Spain**

Toshiba Information Systems  
Parque Empresarial San Fernando  
Edificio Europa, la planta  
Escalera A  
28831 Madrid  
Spain

**Switzerland**

Ozalid AG  
Herostrasse 7  
8048 Zürich  
Switzerland

**United Kingdom**

Toshiba Information Systems  
(U.K) Ltd.  
Toshiba Court  
Weybridge Business Park  
Addlestone Road  
Weybridge/Surrey KT15 2UL  
United Kingdom

**United States**

Toshiba America Information  
Systems, Inc.  
9740 Irvine Boulevard  
Irvine, California 92618  
United States

For the most recent list of addresses, access Toshiba's AUTOFAX system (see "Toshiba's Automated Fax Service" on page 361).

# The Hotkeys

---

Hotkeys are keys that, pressed in combination with the Fn key, turn system functions on and off. Hotkeys have a white legend on the front of the key indicating the option or feature the key controls.

## Instant Password Security

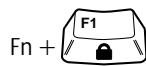

This hotkey locks the keyboard and blanks the display. You must enter your password, if registered, or press Enter to begin work again.

## Power Usage

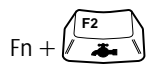

This hotkey displays the power usage pop-up window and switches among battery save modes: Full Power, Low Power, and Custom Settings. The hotkey also works in DOS mode, but doesn't display the pop-up window.

## Resume Mode

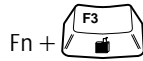

This hotkey displays the Resume Mode pop-up window and turns Resume Mode on and off. The hotkey also works in DOS mode, but doesn't display the pop-up window.

## Sound

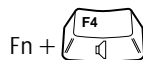

This hotkey cycles the alarm volume through off, low, medium and high. Off is always first.

## Power-on Display

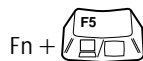

This hotkey alternates among the following power-on display options: built-in display only, external monitor only and simultaneous display.

If you're using an external monitor that can't show resolutions higher than 1024 x 768, it will not work in Simultaneous mode.

## Keyboard

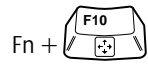

This hotkey turns the cursor control overlay on and off.

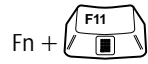

This hotkey turns the numeric overlay on and off.

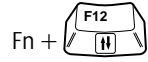

This hotkey turns the scroll lock feature on and off.

# The Toshiba Access Panel

---

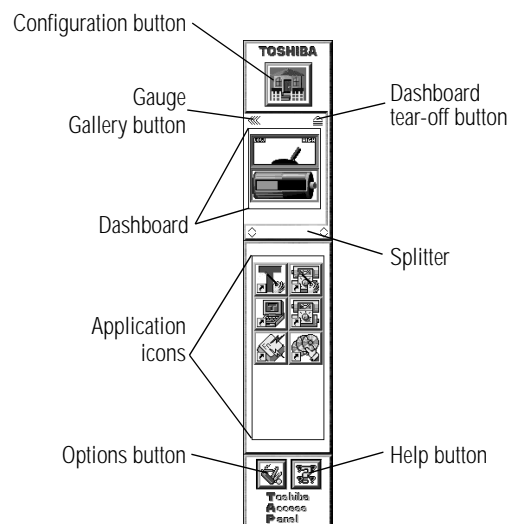

*The Toshiba Access Panel*

The previous illustration identifies the components of the Toshiba Access Panel. The following sections discuss each of the panel's components in detail, as well as the features accessible through these components.

## The Configuration Button



The icon on this button identifies which configuration you're currently using. Clicking this button with the primary AccuPoint button displays the configuration slider bar (discussed in the following section, "The Configuration Slider Bar").

Clicking the configuration button with the secondary AccuPoint button displays a shortcut menu that provides five options:

<i>Menu Option</i>	<i>Result</i>
Show Gauge Gallery	Opens the Gauge Gallery window. If the Gauge Gallery is already open, this option reads "Hide Gauge Gallery."
Undock Dashboard	Removes the dashboard section from the Toshiba Access Panel and displays the gauges in a separate Dashboard window. (See "The Dashboard Window" on page 378.)
Close Toshiba Access Panel	Closes the Toshiba Access Panel.
What's This?	Displays information about the component you clicked.
TAP Properties	Opens the Toshiba Access Panel Properties dialog box (refer to "The Toshiba Access Panel Properties Dialog Box" on page 396).

## The Configuration Slider Bar

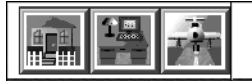

*The configuration slider bar*

This bar displays buttons for the available configurations (in this case, home, office, and travel). To change the current configuration, click the desired configuration button. The slider bar retracts after you make a selection.

## The Gauge Gallery Button



Clicking the gauge gallery button opens the Gauge Gallery, which displays the available TAP gauges and provides a description of each.

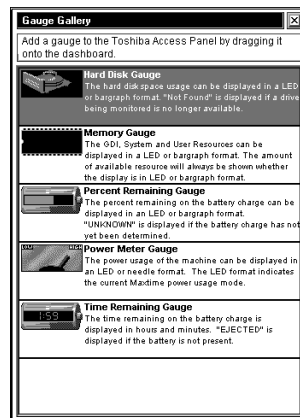

*The Gauge Gallery*

To add a gauge to the TAP, simply click it in the Gauge Gallery and drag it to the dashboard section of the Toshiba Access Panel.

To close the Gauge Gallery, click its close button.



## The Dashboard Tear-Off Button



Clicking the dashboard tear-off button removes the battery gauges from the Toshiba Access Panel and displays them in another window, called the Dashboard window.

## The Dashboard Window



*The Dashboard window*

Clicking the Options menu allows you to choose from the following options:

<i>Menu Option</i>	<i>Result</i>
Dashboard Properties	Displays the Dashboard Properties dialog box (refer to “The Dashboard Properties Dialog Box” on page 379).
Help Contents	Opens Dashboard Help.
About Dashboard	Provides some information about Dashboard.
Exit	Closes the Dashboard window and returns the TAP gauges to the dashboard section of the TAP.

If you click a gauge with the primary AccuPoint button, the properties dialog box for the gauge opens. These dialog boxes are discussed in “The Hard Disk Properties Dialog Box” on page 384, “The Memory Resource Properties Dialog Box” on page 385, “The Percent Remaining Gauge Properties Dialog Box” on page 386, “The Power Meter Properties Dialog Box” on page 387, and “The Time Remaining Gauge Properties Dialog Box” on page 388.

If you click a gauge with the secondary AccuPoint button, a menu appears with the following options:

<i>Menu Option</i>	<i>Result</i>
Gauge Properties	Displays the Properties dialog box for the gauge you clicked.
Remove from All	Removes the gauge from the Dashboard window for all configurations.
Remove from <i>current configuration</i>	Removes the gauge from the Dashboard window for the current configuration.
Show Gauge Gallery	Opens the Gauge Gallery (refer to “The Gauge Gallery Button” on page 377). If the Gauge Gallery is already open, this option reads “Hide Gauge Gallery.”
Hide Title Bar	Hides the title bar on the Dashboard window. If the title bar is already hidden, this option reads “Show Title Bar.”
Dashboard Properties	Displays the Dashboard Properties dialog box (discussed in the following section).

To close the Dashboard window, click its close button.

## The Dashboard Properties Dialog Box

This dialog box provides two pages of options, each with its own tab. To view a page, click its tab.

## The Styles Page

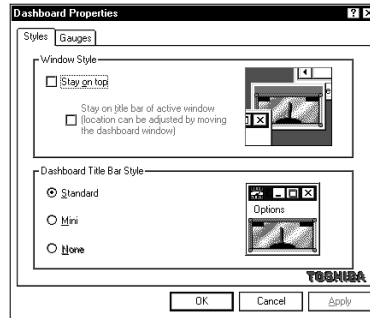

*The Styles page of the Dashboard Properties dialog box*

This page controls the appearance of the Dashboard window.

**Option: Stay on top**

*Usage:* When this option is selected, the Dashboard window displays in front of all other windows on the desktop.

**Option: Stay on title bar of active window**

*Usage:* When this option is selected the Dashboard displays on the title bar of the active window. This option is available only if you select Stay on top.

**Option: Standard**

*Usage:* Displays a standard-sized title bar on the Dashboard window.

**Option: Mini**

*Usage:* Displays a small title bar on the Dashboard window.

**Option: None**

*Usage:* Removes the title bar. This option is only available if you select “Stay on title bar of active window” as the Window Style.

**Option: OK**

*Usage:* Saves your changes and closes the dialog box.

**Option: Cancel**

*Usage:* Discards your changes and closes the dialog box.

**Option: Apply**

*Usage:* Applies your changes to the Dashboard window.

## The Gauges Page

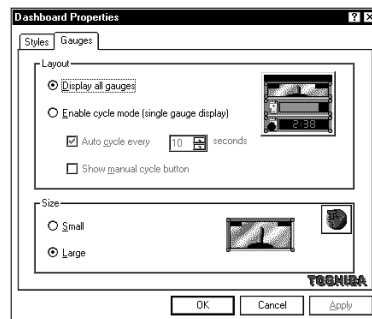

*The Gauges page of the Dashboard Properties dialog box*

This page controls how the gauges display in the Dashboard window:

**Option: Display all gauges**

*Usage:* Displays all the selected gauges at once.

**Option: Enable cycle mode**

*Usage:* Displays one dashboard gauge at a time, changing gauges periodically.

**Option: Auto cycle every xx seconds**

*Usage:* Changes the displayed dashboard gauge every xx seconds. You use the up and down arrows to set the number of seconds. This option is available only if you chose Enable cycle mode.

**Option: Show manual cycle button**

*Usage:* Displays a manual cycle button on the Dashboard window. You click this button to change the gauge displayed. This option is available only if you chose Enable cycle mode.

**Option: Small**

*Usage:* Displays small gauges in the Dashboard window.

**Option: Large**

*Usage:* Displays large gauges in the Dashboard window.

**Option: OK**

*Usage:* Saves your changes and closes the dialog box.

**Option: Cancel**

*Usage:* Discards your changes and closes the dialog box.

**Option: Apply**

*Usage:* Applies your changes to the Dashboard window.

## The Dashboard



*The dashboard section of the Toshiba Access Panel*

The dashboard contains the TAP gauges, which display the current battery charge. Clicking a gauge with the primary AccuPoint button displays a properties dialog box for that gauge. These dialog boxes are discussed in the following sections.

Clicking a gauge with the secondary AccuPoint button displays a shortcut menu that provides three options:

<i>Menu Option</i>	<i>Result</i>
Gauge Properties	Displays the Properties dialog box for the gauge you clicked.
Remove from All	Removes the selected gauge from all configurations.
Remove from <i>current configuration</i>	Removes the selected gauge from the current configuration.
Hide Gauge Gallery	Hides the Gauge Gallery window. If the Gauge Gallery isn't open, this option reads "Show Gauge Gallery."
Undock Dashboard	Removes the gauges from the Toshiba Access Panel and displays them in a separate Dashboard window.
Close Toshiba Access Panel	Closes the Toshiba Access Panel.
What's This?	Displays information about the item you clicked.
TAP Properties	Opens the Toshiba Access Panel Properties dialog box (refer to "The Toshiba Access Panel Properties Dialog Box" on page 396).

## The Hard Disk Properties Dialog Box

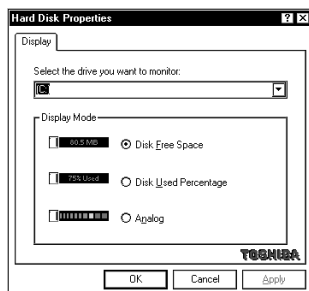

*The Hard Disk Properties dialog box*

This dialog box lets you choose how the Hard Disk Gauge displays:

**Option: Select the drive you want to monitor**

*Usage:* Lets you select which drive you want the Hard Disk Gauge to monitor.

**Option: Disk free space**

*Usage:* When this option is selected, the Hard Disk Gauge displays the amount of free space on the disk.

**Option: Disk used percentage**

*Usage:* When this option is selected, the Hard Disk Gauge displays the percentage of disk space used.

**Option: Analog**

*Usage:* When this option is selected, the Hard Disk Gauge displays the hard disk space in analog format.

**Option: OK**

*Usage:* Saves your changes and closes the dialog box.

**Option: Cancel**

*Usage:* Discards your changes and closes the dialog box.

**Option: Apply**

*Usage:* Applies your changes to the Toshiba Access Panel.

## The Memory Resource Properties Dialog Box

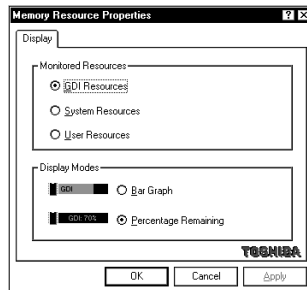

*The Memory Resource Properties dialog box*

This dialog box lets you choose how the Memory Resource Gauge displays:

**Option: GDI Resources**

*Usage:* When this option is selected, the Memory Resource Gauge displays the current status of the GDI resources.

**Option: System Resources**

*Usage:* When this option is selected, the Memory Resource Gauge displays the current status of the system resources.

**Option: User Resources**

*Usage:* When this option is selected, the Memory Resource Gauge displays the current status of the user resources.

**Option: Bar Graph**

*Usage:* When this option is selected, the Memory Resource Gauge displays the current resource status in a bar graph format.



**Option: Percentage Remaining**

*Usage:* When this option is selected, the Memory Resource Gauge displays the percentage of resources remaining.

**Option: OK**

*Usage:* Saves your changes and closes the dialog box.

**Option: Cancel**

*Usage:* Discards your changes and closes the dialog box.

**Option: Apply**

*Usage:* Applies your changes to the Toshiba Access Panel.

## The Percent Remaining Gauge Properties Dialog Box

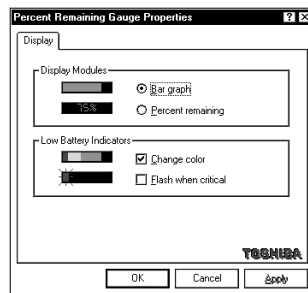

*The Percent Remaining Gauge Properties dialog box*

This dialog box lets you choose how the Percent Remaining Gauge displays.

**Option: Bar graph**

*Usage:* Displays the remaining battery charge as a bar graph.

**Option: Percent remaining**

*Usage:* Displays the percentage of total battery charge remaining.

**Option: Change color**

*Usage:* When this option is selected, the Percent Remaining Gauge changes color to indicate the battery charge: green indicates the charge has not reached either battery alarm threshold, yellow indicates the charge has passed the low battery alarm threshold, and red indicates the charge has passed the critical battery alarm threshold.

**Option: Flash when critical**

*Usage:* When this option is selected, the Percent Battery Remaining Gauge flashes when the charge has passed the critical battery alarm threshold.

**Option: OK**

*Usage:* Saves your changes and closes the dialog box.

**Option: Cancel**

*Usage:* Discards your changes and closes the dialog box.

**Option: Apply**

*Usage:* Applies your changes to the Toshiba Access Panel.

## The Power Meter Properties Dialog Box

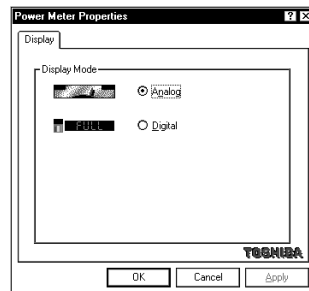

*The Power Meter Properties dialog box*

This dialog box lets you choose how the Power Meter displays.

**Option: Analog**

*Usage:* Displays the remaining battery charge in analog format.

**Option: Digital**

*Usage:* Displays the remaining battery charge in digital format.

**Option: OK**

*Usage:* Saves your changes and closes the dialog box.

**Option: Cancel**

*Usage:* Discards your changes and closes the dialog box.

**Option: Apply**

*Usage:* Applies your changes to the Toshiba Access Panel.

## The Time Remaining Gauge Properties Dialog Box

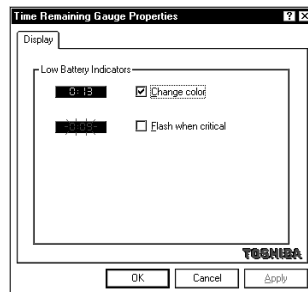

*The Time Remaining Gauge Properties dialog box*

This dialog box lets you choose how the Time Remaining Gauge displays:

**Option: Change color**

*Usage:* When this option is selected, the Time Remaining Gauge changes color to indicate the battery charge: green indicates the charge has not reached either battery alarm threshold, yellow indicates the charge has passed the low battery alarm threshold, and red indicates the charge has passed the critical battery alarm threshold.

**Option: Flash when critical**

*Usage:* When this option is selected, the Time Battery Remaining Gauge flashes when the charge has passed the critical battery alarm threshold.

**Option: OK**

*Usage:* Saves your changes and closes the dialog box.

**Option: Cancel**

*Usage:* Discards your changes and closes the dialog box.

**Option: Apply**

*Usage:* Applies your changes to the Toshiba Access Panel.

## The Splitter

This bar separates the dashboard from the application icons. You can click and drag this bar to change the sizes of the dashboard and the applications area of the panel.

## The Application Icons



*The application area of the Toshiba Access Panel*

This area provides space for the icons used to start programs. To add a program to the application area, click and drag the program icon to the application area.

To rearrange the icons in the application area, click and drag the icons to the desired new locations.

Clicking an application icon with the primary AccuPoint button starts the associated program. Clicking an application icon with the secondary AccuPoint button displays a shortcut menu that provides six options:

<i>Menu Option</i>	<i>Result</i>
Open	Starts the application you clicked.
Remove from All	Removes the selected application icon from all configurations.
Remove from <i>current configuration</i>	Removes the selected application icon from the current configuration.
Close Toshiba Access Panel	Closes the Toshiba Access Panel.
What's This?	Provides information about the icon you clicked.
TAP Properties	Opens the Toshiba Access Panel Properties dialog box (refer to "The Toshiba Access Panel Properties Dialog Box" on page 396).

## The Options Button



Clicking the options button displays the options slider bar.

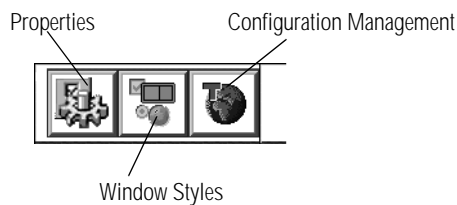

*The options slider bar*

This bar provides access to the panel's customization options. The following table summarizes the functions of the three options buttons.

<i>Button</i>	<i>Function</i>
Properties	Displays the Toshiba Access Panel Properties dialog box (refer to “The Toshiba Access Panel Properties Dialog Box” on page 396).
Window styles	Displays the TAP Windows Styles dialog box (refer to “The TAP Windows Styles Dialog Box” on page 400).
Configuration Management	Displays the Configuration Management dialog box (refer to “The Configuration Management Dialog Box” on page 391).

## The Configuration Management Dialog Box

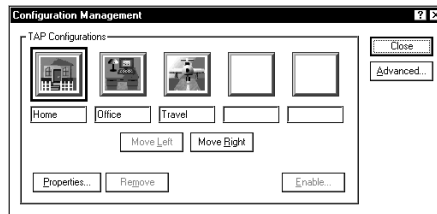

*The Configuration Management dialog box*

You use the Configuration Management dialog box to change the properties of a configuration, create a new configuration, or remove an existing configuration. It provides the following options:

**Option: Move Left**

*Usage:* Moves the selected configuration button on the configuration slider bar one position to the left.

**Option: Move Right**

*Usage:* Moves the selected configuration button on the configuration slider bar one position to the right.

**Option: Properties**

*Usage:* Displays the Configuration Properties dialog box for the selected configuration (refer to “The Configuration Properties Dialog Box” on page 392).

**Option: Remove**

*Usage:* Removes the selected configuration from the system. You cannot remove the currently active configuration.

**Option: Enable**

*Usage:* Displays the Enable Configuration dialog box when an inactive configuration button is selected, allowing you to create a new Toshiba Access Panel configuration (refer to “The Enable Configuration Dialog Box” on page 394).

**Option: Close**

*Usage:* Saves your changes and closes the dialog box.

**Option: Advanced**

*Usage:* Displays the Advanced Configuration Management dialog box for the selected configuration (refer to “The Advanced Configuration Management Dialog Box” on page 395).

## The Configuration Properties Dialog Box

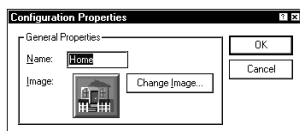

*The Configuration Properties dialog box*

This dialog box displays the properties of the selected configuration. It provides the following options:

**Option: Name**

*Usage:* Provides a place to type in a new name for the configuration.

**Option: Change Image**

*Usage:* Displays the Change Configuration Image dialog box (discussed in the following section).

**Option: OK**

*Usage:* Saves the new properties and closes the dialog box.

**Option: Cancel**

*Usage:* Discards the changes and closes the dialog box.

## The Change Configuration Image Dialog Box

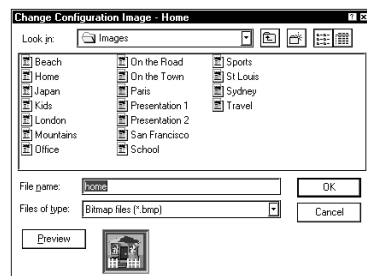

*The Change Configuration Image dialog box*

This dialog box lets you select an image to display on the button for a new or existing configuration. It works similarly to the Windows Open File dialog box.

Select the folder in which the image is located from the Look in list box, then narrow down the search using the File name and Files of type boxes. To view an image you've selected, click Preview.

Once you've chosen an image, click OK to exit the dialog box. To exit the dialog box without choosing a new image, click Cancel.



## The Enable Configuration Dialog Box

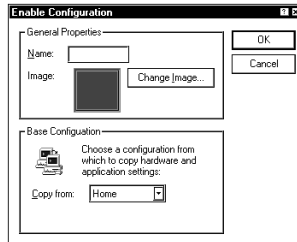

*The Enable Configuration dialog box*

This dialog box appears when you select an unused configuration button from the Configuration Management dialog box and click Enable.

It provides the following options:

**Option: Name**

*Usage:* Provides a place to type in a name for the new configuration.

**Option: Change Image**

*Usage:* Displays the Change Configuration Image dialog box (refer to “The Change Configuration Image Dialog Box” on page 393).

**Option: Copy from**

*Usage:* Lets you select an existing configuration on which to base the new configuration.

**Option: OK**

*Usage:* Saves the new properties and closes the dialog box.

**Option: Cancel**

*Usage:* Discards the changes and closes the dialog box.

## The Advanced Configuration Management Dialog Box

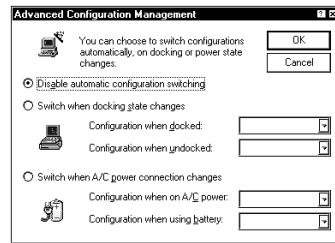

*The Advanced Configuration Management dialog box*

This dialog box determines when the system automatically switches configurations. It provides the following options:

**Option: Disable automatic configuration switching**

*Usage:* Disables all automatic switching. The system changes configurations only when you select a new configuration from the configuration slider bar (refer to “The Configuration Slider Bar” on page 377).

**Option: Switch when docking state changes**

*Usage:* Enables the system to switch configurations when you connect (dock) or disconnect (undock) your computer from the optional NoteDock Enhanced Port Replicator. Selecting this option lets you select the docked configuration name and the undocked configuration name from the two drop-down list boxes.

**Option: Switch when A/C power connection changes**

*Usage:* Enables the system to switch configurations when you change the computer’s power source from A/C to battery, or vice versa. Selecting this option lets you select the A/C power configuration name and the battery power configuration name from the two drop-down list boxes.

**Option: Switch configuration based on hardware profile**

*Usage:* Enables the system to select the configuration based on the current Windows 95 hardware profile.

This option appears only if you have multiple Windows 95 hardware profiles on your computer.

Selecting this option enables the Hardware Profile and TAP Configuration drop-down list boxes. Select a hardware profile, then select the TAP configuration with which you want to associate it.

**Option: OK**

*Usage:* Saves your changes and closes the dialog box.

**Option: Cancel**

*Usage:* Discards your changes and closes the dialog box.

## The Toshiba Access Panel Properties Dialog Box

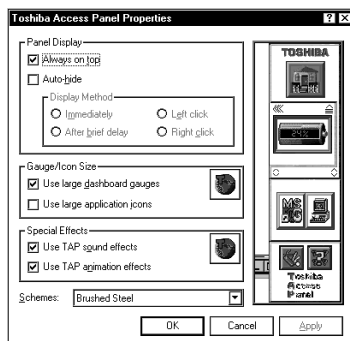

*The Toshiba Access Panel Properties dialog box*

This dialog box lets you define the characteristics of the Toshiba Access Panel itself. It provides the following options:

**Option: Always on top**

*Usage:* When this check box is selected, the TAP displays on top of all other windows. When this check box is cleared, the panel can be covered by other windows.

**Option: Auto-hide**

*Usage:* When this check box is selected, the panel recedes into the edge of the desktop when it's not being used. The options in the Display Method section of this dialog box control when the panel reappears.

**Option: Immediately**

*Usage:* Causes the panel to reappear as soon as you place the cursor at the edge of the screen where the panel displays. This option is available only if you selected Auto-hide.

**Option: After brief delay**

*Usage:* Causes the panel to reappear two seconds after you place the cursor at the edge of the screen where the panel displays. This option is available only if you selected Auto-hide.

**Option: Left click**

*Usage:* Causes the panel to reappear when you position the cursor at the edge of the screen where the panel displays and click the primary AccuPoint button. This option is available only if you selected Auto-hide.

**Option: Right click**

*Usage:* Causes the panel to reappear when you position the cursor at the edge of the screen where the panel displays and click the secondary AccuPoint button. This option is available only if you selected Auto-hide.

**Option: Use large dashboard gauges**

*Usage:* Displays the TAP gauges in a large format.

**Option: Use large application icons**

*Usage:* Displays the application icons on the panel in a large format.

**Option: Configuration button (in Gauge/Icon Size section)**

*Usage:* Opens the Gauge/Icon Size dialog box (refer to “The Gauge/Icon Size Dialog Box” on page 399) and lets you assign different gauge and icon sizes to each configuration.

**Option: Use TAP sound effects**

*Usage:* When this check box is selected, TAP automatically associates sound effects with the following events:

- Bar reappear (from auto-hide)
- Sliderbar slideout
- Dashboard undock
- Dashboard redock

**Option: Use TAP animation effects**

*Usage:* When this check box is selected, TAP automatically animates actions for the following system events:

- Bar auto-hide
- Bar reappear (from auto-hide)
- Sliderbar slideout
- Sliderbar retract
- Dashboard undock
- Dashboard redock

**Option: Configuration button (in Special Effects section)**

*Usage:* Opens the Special Effects dialog box (refer to “The Special Effects Dialog Box” on page 399) and lets you assign different Special Effect settings to each configuration.

**Option: Schemes**

*Usage:* Displays the current scheme for how the TAP displays. To change the scheme, select a new scheme from the drop-down list box.

**Option: OK**

*Usage:* Saves your changes and closes the dialog box.

**Option: Cancel**

*Usage:* Discards your changes and closes the dialog box.

**Option: Apply**

*Usage:* Applies your changes to the TAP.

### The Gauge/Icon Size Dialog Box

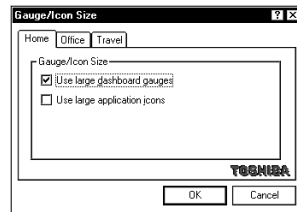

*The Gauge/Icon Size dialog box*

This dialog box lets you assign different gauge/icon sizes to each TAP configuration. The options are the same as the Toshiba Access Panel Properties dialog box (refer to “The Toshiba Access Panel Properties Dialog Box” on page 396).

### The Special Effects Dialog Box

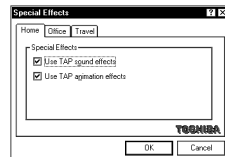

*The Special Effects dialog box*

This dialog box lets you assign different special effects to each TAP configuration. The options are the same as the Toshiba Access Panel Properties dialog box (refer to “The Toshiba Access Panel Properties Dialog Box” on page 396).

## The TAP Windows Styles Dialog Box

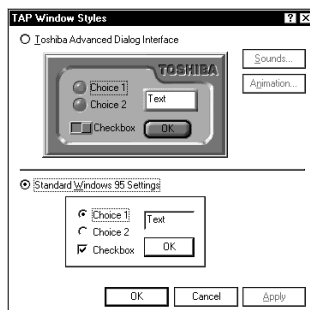

*The TAP Windows Styles dialog box*

This dialog box allows you to select how the TAP system components display—in the Toshiba Advanced Dialog Interface or the Windows 95 window style.



NOTE

*The images in the TAP Window Styles dialog box are examples of the two windows styles from which you can choose. They do not contain active controls.*

---

If you try to access this dialog box and your computer's display is set to 256 colors or lower, the system displays an error message. To change your system's color display, follow the instructions in the error message.

This dialog box provides the following options:

**Option: Toshiba Advanced Dialog Interface**

*Usage:* When this option is selected, the TAP components display with the Toshiba Advanced Dialog Interface graphic styles, sounds and animation.

**Option: Sounds**

*Usage:* Displays the Sounds dialog box (refer to “The Sounds Dialog Box” on page 401).

**Option: Animation**

*Usage:* Displays the Animation dialog box (refer to “The Animation Dialog Box” on page 405).

**Option: Standard Windows 95 Settings**

*Usage:* Displays TAP components in the Normal Windows 95 style.

**Option: OK**

*Usage:* Saves your changes and closes the dialog box.

**Option: Cancel**

*Usage:* Discards your changes and closes the dialog box.

**Option: Apply**

*Usage:* Applies your changes to the TAP.

## The Sounds Dialog Box

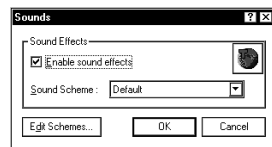

*The Sounds dialog box*

This dialog box allows you to select a sound scheme to use with the Toshiba Advanced Dialog Interface. It provides the following options:

**Option: Enable sound effects**

*Usage:* When this option is selected, sounds defined by the chosen sound scheme are enabled.

**Option: Sound Scheme**

*Usage:* Lets you select a sound scheme from the drop-down list box.



**Option: Configuration button**

*Usage:* Displays the Sound Effects dialog box (refer to “The Sound Effects Dialog Box” on page 402) and allows you to set different sound effects for each configuration.

**Option: Edit Schemes**

*Usage:* Displays the Edit Sound Schemes dialog box (refer to “The Edit Sound Schemes Dialog Box” on page 403).

**Option: OK**

*Usage:* Saves your changes and closes the dialog box.

**Option: Cancel**

*Usage:* Discards your changes and closes the dialog box.

## The Sound Effects Dialog Box

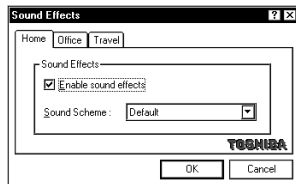

*The Sound Effects dialog box*

This dialog box lets you assign specific sound effects to each of your configurations. The options are the same as the Sounds dialog box (refer to “The Sounds Dialog Box” on page 401).

## The Edit Sound Schemes Dialog Box

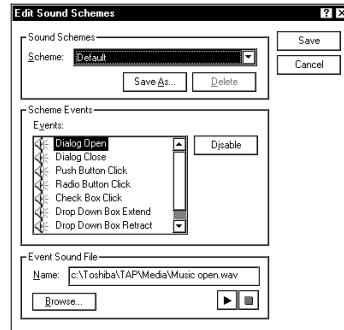

*The Edit Sound Schemes dialog box*

This dialog box allows you to change the sound properties of any Toshiba Advanced Dialog Interface sound scheme present on the system, to create new schemes or remove any scheme other than “Default.” It provides the following options:

**Option: Scheme**

*Usage:* Displays the currently selected scheme. You can select another scheme from the drop-down list box.

**Option: Save As**

*Usage:* Lets you save the selected scheme with a new name.

**Option: Delete**

*Usage:* Removes the selected scheme from the system. You cannot delete “Default.” The sound files are not deleted from the system.

**Option: Events**

*Usage:* Displays all possible sound events in the selected scheme. A loud-speaker icon indicates an event is currently enabled.

**Option: Disable/Enable**

*Usage:* Changes the state of the event. If the selected event is enabled, this button has the caption “Disable.” If the even is disabled, this button has the caption “Enable.”

**Option: Name**

*Usage:* Shows the current sound file name. You can edit the file name in this text box.

**Option: Browse**

*Usage:* Displays the Browse for Event Sound dialog box (refer to “The Browse for Event Sound Dialog Box” on page 405).

**Option: Play button (triangle)**

*Usage:* Plays the sound file currently listed in the Name box.

**Option: Stop button (square)**

*Usage:* Stops playing the sound file.

**Option: Save**

*Usage:* Saves your changes and closes the dialog box.

**Option: Cancel**

*Usage:* Discards your changes and closes the dialog box.

## The Browse for Event Sound Dialog Box

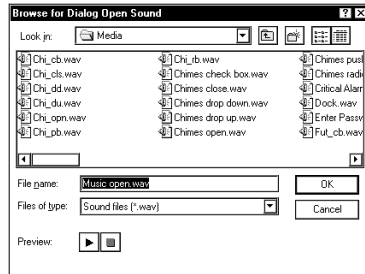

*The Browse for Event Sound dialog box*

Use this dialog box as you would the Windows 95 Open File dialog box. Specify the folder in which the file is located in the Look in box, then narrow the search further using the Files of type and File name boxes.

To play a selected sound file, click the play button (the triangle). To stop a sound file when its playing, click the stop button (the square).

Once you've chosen a sound file for the event, click OK to save your changes and close the dialog box. Click Cancel to discard your changes and close the dialog box.

## The Animation Dialog Box

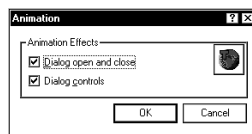

*The Animation dialog box*

This dialog box controls the animation sequences that are part of the Toshiba Advanced Dialog Interface.

It provides the following options:

**Option: Dialog open and close**

*Usage:* When this option is selected, dialog boxes accessed through the TAP animate when opened and closed.

**Option: Dialog controls**

*Usage:* When this option is selected, the dialog controls are animated.

**Option: Configuration button**

*Usage:* Displays the Animation Effects dialog box (refer to “The Animation Effects Dialog Box” on page 406), which allows you to set unique animation effects for each TAP configuration.

**Option: OK**

*Usage:* Saves your changes and closes the dialog box.

**Option: Cancel**

*Usage:* Discards your changes and closes the dialog box.

## The Animation Effects Dialog Box

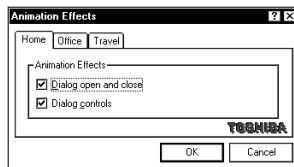

*The Animation Effects dialog box*

This dialog box lets you assign Toshiba Advanced Dialog Interface effects to specific configurations. The options are the same as the Animation dialog box (refer to “The Animation Dialog Box” on page 405).

## The Help Button



Clicking the help button displays the help slider bar. This bar provides access to TAP on-line help.

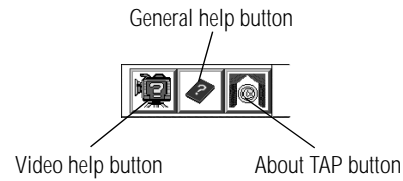

*The help slider bar*

The following table summarizes the functions of the three buttons on this bar:

<i>Button</i>	<i>Function</i>
Video Help	Displays the Video Help dialog box, allowing you to view a few videos that demonstrate how to use the Toshiba Access Panel.
General Help	Displays a standard Windows 95 Help dialog box.
About TAP	Displays information about the Toshiba Access Panel program.

# The MaxTime Control Panel

---

You can use the MaxTime Wizard or the MaxTime Control Panel to customize the Tecra 740CDT power saving features.



To use the MaxTime Wizard, click its button on the Toshiba Access Panel and follow the instructions on the screen.

To enter your power settings using the MaxTime Control Panel, follow these steps:

- 1 Click Start, then point to Settings.**
- 2 Click Control Panel.**

Windows 95 opens the Control Panel.



MaxTime

- 3 Double-click the MaxTime icon.**

The MaxTime Control Panel opens.

The MaxTime Control Panel provides three pages of configuration options, arranged like a stack of file folders. Each page of options has its own tab.

To view or change these options, click the corresponding tab.

## 410 The MaxTime Control Panel *The Power Settings Page*

---

The four buttons at the bottom of the MaxTime Control Panel perform the following functions:

*Button    Function*

OK        Saves current settings and exits the MaxTime Control Panel.

Cancel    Ignores current settings and exits the MaxTime Control Panel.

Apply     Applies the settings to the current session.

Help      Opens on-line help.

## The Power Settings Page

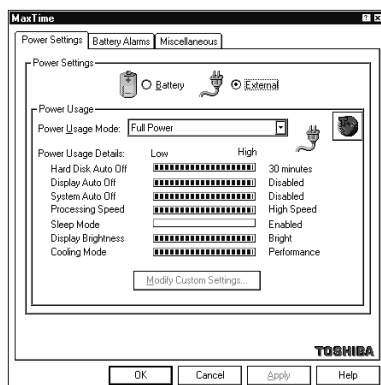

*The Power Settings page*

This page controls the power usage mode and the custom settings for both battery and external power usage.

**Option:** Power Settings

**Settings:** Battery  
External

**Usage:** Lets you choose the power source for which you are selecting power usage settings.

*Part II: Technical Reference*



**Option: Power Usage Mode**

*Settings:* Full Power (default)  
Low Power  
Custom Settings

*Usage:* Allows you to select a preset battery save mode or customize the battery save options. For more information about choosing a power usage mode, see “The Easy Way—Choosing a Power Usage Mode” on page 155.

**Option: Hard Disk Auto Off**

*Settings:* 1 Min.  
3 Min. (Low Power default)  
5 Min.  
10 Min.  
15 Min.  
20 Min.  
30 Min. (Full Power default)

*Usage:* Turns the hard disk drive off if it is not used for the time selected. For more information, see “Hard Disk Auto Off (HDD Auto Off)” on page 158.

**Option: Display Auto Off**

*Settings:* 1 Min.  
3 Min. (Low Power default)  
5 Min.  
10 Min.  
15 Min.  
20 Min.  
30 Min. (Full Power default)  
Disabled

*Usage:* Turns the display off if it is not used for the time selected. For more information, see “Display Auto Off” on page 158.

**Option: System Auto Off**

*Settings:* 10 Min.  
20 Min.  
30 Min. (Low Power default if computer is in Resume Mode)  
40 Min.  
50 Min.  
60 Min.  
Disabled (Full and Low Power default)

*Usage:* Turns the system off if you haven't used the computer for the time selected. For more information, see “System Auto Off” on page 158.

**Option: Processing Speed**

*Settings:* High (Full Power default)  
Low (Low Power default)

*Usage:* Sets the speed at which the Central Processing Unit (CPU) processes information. For more information, see “Processing Speed” on page 159.

**Option: Sleep Mode**

*Settings:* Enabled (Full and Low Power default)  
Disabled

*Usage:* When enabled, temporarily shuts down the processor when there are no processing requests, such as keyboard input or pointing device movement. For more information, see “Sleep Mode (CPU Sleep Mode)” on page 159.

**Option: Display Brightness**

*Settings:* Super-Bright (Full Power default—External Power)  
Bright (Full Power default—Battery Power, Low Power default—External Power)  
Semi-Bright (Low Power default—Battery Power)

*Usage:* Sets the brightness of the display. For more information, see “Display Brightness (LCD Brightness)” on page 159.

**Option: Cooling Mode**

*Settings:* Performance (Full Power default)  
Quiet (Low Power default)

*Usage:* Determines the method used to cool the computer's processor chip. For more information see "Cooling Mode (Cooling Method)" on page 160.

## The Battery Alarms Page

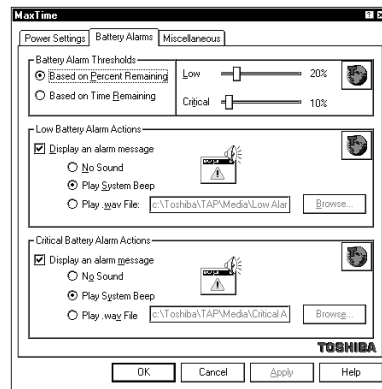

*The Battery Alarms page*

This page controls the settings for the Low Battery Alarm and the Critical Battery Alarm.

**Option: Battery Alarm Thresholds**

*Settings:* Based on Percent Remaining  
Based on Time Remaining

*Usage:* Triggers the alarm based on either the Percent Remaining or Time Remaining Threshold. Sliders to the right of this option let you set the thresholds for the Low and Critical Battery Alarms.

The lower half of the Battery Alarms page controls how the system displays the battery alarm messages. These options are identical for both the Low Battery Alarm and the Critical Battery Alarm.

**Option: Display an alarm message**

*Settings:* Enabled (check)  
Disabled (no check)

*Usage:* Enables and disables the battery alarm message. If you enable the alarm message, you can choose the sound that occurs when the alarm message appears: No Sound, Play System Beep, or Play .wav file.

For more information about setting the battery alarms, refer to “Setting the Alarms” on page 147.

## The Miscellaneous Page

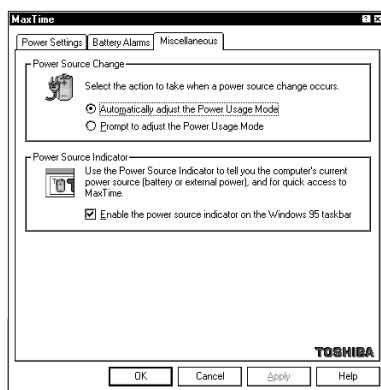

*The Miscellaneous page*

This page controls the following options:

**Option: Power Source Change**

*Settings:* Automatically adjust the Power Usage Mode  
Prompt to adjust the Power Usage Mode

*Usage:* Controls how the system behaves when you change the computer from battery power to AC power, or vice versa.

**Option:** Enable the power source indicator on the Windows 95 taskbar

*Settings:* Enabled (check)  
Disabled (no check)

*Usage:* Turns the Toshiba power source indicator on the taskbar on and off.

# The Toshiba System Control Panel

---

To open the Toshiba System Control Panel, follow these steps:

**1 Click Start, then point to Settings.**

**2 Click Control Panel.**

Windows 95 opens the Control Panel.



**3 Double-click the Toshiba System icon.**

The Toshiba System Control Panel opens.

The Toshiba System Control Panel provides four pages of configuration options, arranged like a stack of file folders. Each page of options has its own tab.

To view or change these options, click the corresponding tab.

The four buttons at the bottom of the Toshiba System Control Panel perform the following functions:

<i>Button</i>	<i>Function</i>
OK	Saves current settings and exits the Toshiba System Control Panel.
Cancel	Ignores current settings and exits the Toshiba System Control Panel.
Apply	Applies the settings to the current session.
Defaults	Returns the settings to their default values.

## The Start Up Options Page

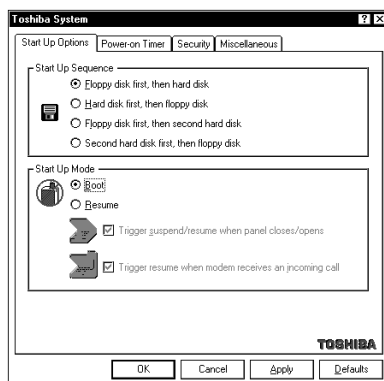

*The Start Up Options page*

The options on this page control how the system starts.

### **Option: Start Up Sequence**

*Settings:* Floppy disk first, then hard disk  
Hard disk first, then floppy disk  
Floppy disk first, then second hard disk  
Second hard disk first, then floppy disk

*Usage:* Determines whether the system looks for the operating system first when you turn the computer on: on the built-in hard disk, the diskette drive, or the second hard disk in the optional Desk Station V Plus. This option is equivalent to the Boot Priority option in TSETUP.

**Option: Start Up Mode**

*Settings:* Boot  
Resume

*Usage:* Alternates between Resume Mode and Boot Mode. This option is equivalent to the Power-up Mode option in TSETUP.

**Option: Trigger suspend/resume when panel closes/opens**

*Settings:* Enabled (check)  
Disabled (no check)

*Usage:* Turns the computer on or off when you open or close its display panel. This option is available only when Resume Mode is turned on. This option is equivalent to the Panel Power On/Off option in TSETUP.



## The Power-On Timer Page

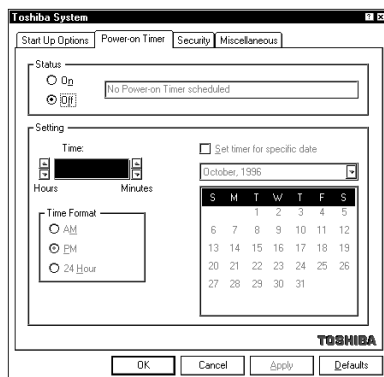

*The Power-On Timer page*

This page lets you set the system to turn on automatically at a time and date you specify.

**Option: Status**

*Settings:* On  
Off

*Usage:* Turns the computer on at a given time. If you choose On, a message to the right of the option displays the scheduled start up time. This option is equivalent to the Alarm Power On option in TSETUP.

**Option: Time**

*Settings:* xx:xx

*Usage:* Lets you specify the time at which the system turns on. Click the up and down arrows to change the time displayed in the box.

**Option: Time Format**

*Settings:* AM  
PM  
24 Hour

*Usage:* Lets you set the format in which the time displays.

**Option: Set time for specific date**

*Settings:* Enabled (check)  
Disabled (no check)

*Usage:* Enabling this option lets you specify the date on which the system turns on automatically. Choose a date from the calendar below the option.

## The Security Page

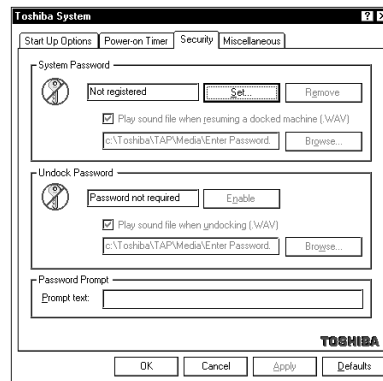

*The Security page*

This page allows you to protect your system from unauthorized use by setting a System Password.

**Option: System Password**

*Settings:* Registered  
Not Registered

*Usage:* Shows whether you've set a system password. For information about using a system password, refer to "Using a Password" on page 259.

**Option: Play sound file when resuming a docked machine**

*Settings:* Enabled (check)  
Disabled (no check)

*Usage:* When enabled, this option lets you assign a sound file to play when you resume a computer that is connected to the Desk Station V Plus.



*It is very important to enable a sound if you're using a password with the Desk Station V Plus, since this is the only prompt you will receive to enter your password when resuming a docked computer.*

---

**Option: Undock Password**

*Settings:* Password not required  
Password required

*Usage:* Shows whether you've set an undock password. For information about using an undock password, refer to "Using an Undock (Eject) Password" on page 274.

**Option: Play sound file when undocking**

*Settings:* Enabled (check)  
Disabled (no check)

*Usage:* When enabled, this option lets you assign a sound file to play when you undock your computer from the Desk Station V Plus.

**Option: Password Prompt**

*Usage:* This option lets you type in the text you wish the system to display when it starts and prompts you for your password. The text you enter here appears on the line before the "Password=" prompt. For example, you might use "Enter your personal password please..."

## The Miscellaneous Page

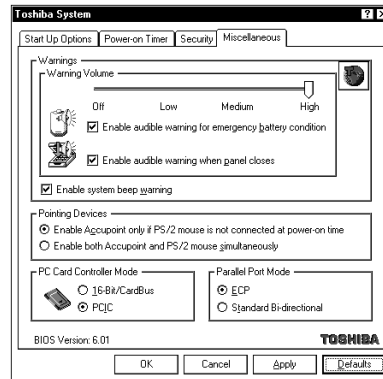

*The Miscellaneous page*

This page controls options related to the system's warnings, pointing devices, and parallel port.

### **Option: Warning Volume**

*Settings:* Off  
Low  
Medium  
High

*Usage:* Sets the volume at which the low battery alarm and other system alarms beep. This also affects sounds generated by any PC Card modem installed. This option is equivalent to the Alarm Volume option in TSETUP.

### **Option: Enable audible warning for emergency battery condition**

*Settings:* Enabled (check)  
Disabled (no check)

*Usage:* Enables and disables the system's built-in audible battery alarm. This option is equivalent to the Low Battery Alarm option in TSETUP.

**Option: Enable audible warning when panel closes**

*Settings:* Enabled (check)  
Disabled (no check)

*Usage:* Enables and disables the alarm that sounds when you close the display panel while the computer is on. For more information, see “How and When to Turn the Computer Off” on page 120. This option is equivalent to the Panel Close Alarm option in TSETUP.

**Option: Enable system beep warning**

*Settings:* Enabled (check)  
Disabled (check)

*Usage:* Enables and disables your software’s use of the system speaker. This affects alarms and system beeps, but not the sound system. This option is equivalent to the System Beep option in TSETUP.

**Option: Pointing Devices**

*Settings:* Enable AccuPoint only if PS/2 mouse is not connected at power-on time  
Enable both AccuPoint and PS/2 mouse simultaneously

*Usage:* Selects whether an external pointing device disables the AccuPoint. This option is equivalent to the Pointing Devices option in TSETUP. This option does not affect serial pointing devices.

**Option: PC Card Controller Mode**

*Settings:* PCIC  
16-Bit/CardBus (default)

*Usage:* Sets up the PC Card controller. This option affects all PC Card slots in the system, including any installed in an optional Desk Station V Plus or NoteDock II Enhanced Port Replicator. Set this option to 16-Bit/CardBus only if you are using a PC Card that is CardBus compatible.

*Restart:* Y

**Option: Parallel Port Mode**

*Settings:* ECP (default)  
Standard Bi-directional

*Usage:* Lets you choose the parallel port mode. Set this option to Standard Bi-directional if the documentation for your parallel device instructs you to do so, or if you are having problems with your printer or other parallel device.

# TSETUP

---

---



NOTE

*TSETUP only runs outside of Windows 95, at a system prompt.*

---

To open TSETUP, follow these steps:

**1 From Windows 95, Click Start, then click Shut Down.**

Windows 95 displays the Shut Down Windows dialog box.

**2 Click Restart the computer in MS-DOS mode, then click Yes.**

Windows 95 shuts down the computer, then restarts it in MS-DOS mode and displays a system prompt.

**3 At the system prompt, type `c:\dos\tsetup` and press Enter.**

TSETUP displays the first page of the System Setup screen.

The TSETUP options are arranged on two pages. The following sections describe how to make changes in TSETUP and list the setup options on each page.

## Making Changes in TSETUP

This table lists the keys to use in TSETUP.

<i>Key(s)</i>	<i>Result</i>
← and →	Moves between the two columns.
↑ and ↓	Moves between items in a column.
Spacebar and BkSp	Changes the selected item.
PgDn and PgUp	Switch between the first and second pages.
Esc	Quits TSETUP without saving changes.
End	Saves your changes and quits TSETUP, restarting the computer if necessary.
Home	Resets each option to its factory preset value.



*When you're making changes in TSETUP, it's possible to create a resource conflict (for example, you might set both the serial port and sound to IRQ7). If this occurs, TSETUP displays a message notifying you of the conflict. Change the settings to resolve the conflict before saving your changes and exiting TSETUP.*

---

## Closing TSETUP

To close TSETUP and keep your changes, press End. When TSETUP asks you to confirm your action, press Y. TSETUP closes with your changes in effect and restarts the computer or returns you to the system prompt, depending on the changes you made.

To close TSETUP without saving your changes, press Esc, then Y. TSETUP returns you to the system prompt.



If you attempt to close TSETUP with one or more resource conflicts resulting from your changes, TSETUP will display an error message. You may choose to exit anyway, or return to TSETUP and resolve the conflict.

## The First Page

```

                                SYSTEM SETUP (1/2)                                BIOS version = x.xx
----- MEMORY -----
Total                               = 16384KB

----- DISPLAY -----
Display Adaptor                       = VGA compatible
LCD Display Colors                     = 256K Colors
Power On Display                       = Internal/External
LCD Display Stretch                    = Disabled

----- PASSWORD -----
Not Registered

----- HARD DISK -----
Built-in HDD                           = Enhanced IDE (Normal)

----- BATTERY -----
Battery Save Mode                     = Full Power

----- OTHERS -----
Power-up Mode                         = Boot
CPU Cache                             = Enabled
Level2 Cache                          = Enabled
Auto Power On                         = Disabled
Alarm Volume                          = High
System Beep                           = Enabled

Ext. Keyboard "Fn"                   = Disabled
Boot Priority                          = FDD->Built-In HDD
Pointing Devices                      = Auto-Selected
PC Card Controller Mode               = PCIC Compatible

↑↓←→: Select items   Space, Bksp: Change values   PgDn, PgUp: Change pages
Esc: Exit without saving   Home: Set default values   End: Save changes and Exit
    
```

*The first page of the System Setup screen*

## The MEMORY Section

This section shows how much memory the computer has installed.

*Memory Type*      *Description*

Total              displays the total amount of memory installed in the computer.

This value is calculated by the system and cannot be changed.

## The DISPLAY Section

This section configures the Liquid Crystal Display (LCD) and video port output.

**Option:** Display Adaptor

*Settings:* VGA Compatible (default)  
Not Used

*Usage:* Turns the computer's internal display adapter on or off.

*Restart:* Y

**Option: LCD Display Colors**

*Settings:* 256K Colors

*Usage:* Displays the number of colors available to the display.

*Restart:* N/A

**Option: Power On Display**

*Settings:* Internal/External (default)  
Simultaneous

*Usage:* Controls whether the system sends output to the internal display, the external display, or both when you turn the computer on in boot mode.

*Restart:* Y

**Option: LCD Display Stretch**

*Settings:* Enabled  
Disabled (default)

*Usage:* The screen has a height of 768 pixels. When you're running a program which uses 400 pixels (such as many DOS games and DOS word processing programs), this leaves a blank space above and below the text on the screen. Enabling this mode stretches the text or graphics to fill more of the screen. This mode only has an effect when you run the computer in DOS mode, or when you're using Windows with a VGA monitor.

*Restart:* N

---

## The PASSWORD Section

This section lets you set or reset the system password. See “Using a Password” on page 259 for complete information on your computer’s password features.

<i>Settings</i>	<i>Restart</i>
Registered	N
Not Registered (default)	

## The HARD DISK Section

This section lets you set the hard drive mode. There will always be an option for Built-In HDD. This is the computer’s built-in hard disk.

If you’ve installed a hard disk module in the computer’s SelectBay, there will also be settings for Int. Selectable Bay HDD. If you’ve installed a hard disk module in the optional Desk Station V Plus’ SelectBay, its settings will be under DS Selectable Bay HDD. If you’ve installed an additional hard disk in the Desk Station V Plus’ 5-inch drive bay, its settings will be under DS 5" Drive Bay HDD.



NOTE

*If you change the mode for one hard drive, the mode for the other hard drive (if one is installed) will also change.*

---

### Option: Mode

*Settings:* Enhanced IDE (Normal) (default)  
Standard IDE

*Usage:* Use Enhanced for MS-DOS or Windows or OS/2. Use Standard for Novell Netware, or Unix environments that do not recognize hard disks larger than 540MB.

*Restart:* Y

## The BATTERY Section

The options in this section lets you set the computer's power-saving options.

### **Option: Battery Save Mode**

*Settings:* Full Power (default)  
Low Power  
User Settings

*Usage:* Allows you to select a preset battery save mode or customize the battery save options. For more information about choosing a battery save mode, see “The Easy Way—Choosing a Power Usage Mode” on page 155.

*Restart:* N

When you select the Battery Save Mode, a drop-down box appears with the battery save options. You can change these option settings only if you chose User Settings for the Battery Save Mode.

### **Option: Processing Speed**

*Settings:* High (Full Power default)  
Low (Low Power default)

*Usage:* Sets the speed at which the Central Processing Unit (CPU) processes information. High runs at 166MHz. Low adds pauses, effectively reducing processing speed.

*Restart:* N

### **Option: CPU Sleep Mode**

*Settings:* Enabled (Full and Low Power default)  
Disabled

*Usage:* When enabled, temporarily shuts down the processor when there are no processing requests, such as keyboard input or pointing device movement. For more information, see “Sleep Mode (CPU Sleep Mode)” on page 159.

*Restart:* N

**Option: Display Auto Off**

*Settings:* 01 Min.  
03 Min. (Low Power default)  
05 Min.  
10 Min.  
15 Min.  
20 Min.  
30 Min. (Full Power default)  
Disabled

*Usage:* Turns the display off if it is not used for the time set. For more information, see “Display Auto Off” on page 158.

*Restart:* N

**Option: HDD Auto Off**

*Settings:* 01 Min.  
03 Min. (Low Power default)  
05 Min.  
10 Min.  
15 Min.  
20 Min.  
30 Min. (Full Power default)

*Usage:* Turns the hard disk drive off if it is not used for the time set.

*Restart:* N

**Option: System Auto Off**

*Settings:* 10 Min.  
20 Min.  
30 Min. (Low Power default)  
40 Min.  
50 Min.  
60 Min.  
Disabled (Full Power default)

*Usage:* Turns the system off if you haven't used the computer for the time set. This option is available only if Resume Mode is on. For more information, see "System Auto Off" on page 158.

*Restart:* N

**Option: LCD Brightness**

*Settings:* Super-Bright (Full Power default—External Power)  
Bright (Full Power default—Battery Power, Low Power default—External Power)  
Semi-Bright (Low Power default—Battery Power)

*Usage:* Sets the brightness of the display. For more information, see "Display Brightness (LCD Brightness)" on page 159.

*Restart:* N

**Option: Cooling Method**

*Settings:* Performance (Full Power default)  
Quiet (Low Power default)

*Usage:* Sets the cooling method.

Performance mode uses the fan to cool the processor chip, maintaining maximum system performance.

Quiet mode cools the system by temporarily reducing processing speed instead of using the fan, conserving battery life.

*Restart:* N

---

## The OTHERS Section

This section allows you to set many other configuration options. Whether or not you need to use these options depends primarily on the software and devices you use.

### **Option: Power-up Mode**

*Settings:* Resume  
Boot (default)

*Usage:* Alternates between Resume Mode and Boot Mode.

*Restart:* N

### **Option: CPU Cache**

*Settings:* Enabled (default)  
Disabled

*Usage:* Improves system performance when enabled. Disable this option only if your programs and/or optional devices require you to do so.

*Restart:* Y

If you set the CPU Cache option to Enabled, a drop-down box lets you set the Write Policy option.

### **Option: Write Policy**

*Settings:* Write-back (default)  
Write-through

*Usage:* Write-back provides maximum performance. Write-through reduces performance to offer compatibility with older programs that may not run on a fast system.

*Restart:* Y

### **Option: Level2 Cache**

*Settings:* Enabled (default)  
Disabled

*Usage:* Improves performance when enabled. This option only appears if the CPU Cache option is Enabled. Disable this option only if your programs and/or optional devices require you to do so.

*Restart:* Y

**Option: Auto Power On**

*Settings:* Enabled  
Disabled (default)

*Usage:* Turns the computer on at a time and date you set. When you enable this option, a box appears, allowing you to set the Alarm Time, Alarm Date, and Ring Indicator options. For more information about Auto Power On, see “Different Ways to Turn the Computer On” on page 306.

*Restart:* N

**Option: Alarm Time**

*Settings:* 00:00:00  
Disabled (default)

*Usage:* Lets you set a time (in hours and minutes) at which the computer will turn on automatically. This option is only available if you set the Auto Power On option to Enabled.

*Restart:* N

**Option: Alarm Date**

*Settings:* Disabled  
01-01

*Usage:* Lets you set a date (month and day) on which the computer will turn on automatically. This option is only available if you set an Alarm Time.

*Restart:* N

**Option: Ring Indicator**

*Settings:* Disabled  
Enabled



*Usage:* Turns the computer on automatically when the modem detects an incoming call. This option is only available when Resume Mode is turned on.

*Restart:* N

**Option: Alarm Volume**

*Settings:* Off  
Low  
Medium  
High (default)

*Usage:* Sets the volume at which the system's alarms beep (such as the low battery alarm). This also affects sounds generated by any PC Card modem installed.

*Restart:* N

When you highlight the Alarm Volume option, a box appears that lets you set Low Battery Alarm and Panel Close Alarm.

**Option: Low Battery Alarm**

*Settings:* Enabled (default)  
Disabled

*Usage:* Enables and disables the system's built-in audible battery alarm.

*Restart:* N

**Option: Panel Close Alarm**

*Settings:* Enabled (default)  
Disabled

*Usage:* Enables and disables the alarm that sounds when you close the display panel while the computer is on. For more information, see "How and When to Turn the Computer Off" on page 120.

*Restart:* N

**Option: System Beep**

*Settings:* Enabled (default)  
Disabled

*Usage:* Enables and disables your software's use of the system speaker. This affects alarms and system beeps, not the sound system.

*Restart:* N

**Option: Panel Power On/Off**

*Settings:* Enabled  
Disabled (default)

*Usage:* Turns the computer on/off when you open/close the computer's display panel. This option is only available when Resume Mode is selected. For more information, see "Different Ways to Turn the Computer On" on page 306.

*Restart:* N

**Option: Ext. Keyboard "Fn" Key Equivalent**

*Settings:* Disabled (default)  
Left-Ctrl + Left-Alt  
Right-Ctrl + Right-Alt  
Left-Alt + Left-Shift  
Right-Alt + Right-Shift  
Left-Alt + CapsLock

*Usage:* Allows you to use the selected key combination to emulate the computer's Fn key on an external keyboard. For more information, see "Making Your External Keyboard Pretend it Has the Fn Key" on page 241.

*Restart:* N

**Option: Boot Priority**

*Settings:* FDD→Built-in HDD (default)  
Built-in HDD→FDD  
FDD→Second HDD  
Second HDD→FDD

*Usage:* Determines where the system looks for the operating system first when you turn the computer on: on the built-in hard disk (Built-in HDD), the diskette drive (FDD), or the second hard disk (Second HDD) in the optional Desk Station V Plus.

*Restart:* N

**Option: Pointing Devices**

*Settings:* Auto-selected (default)  
Simultaneous

*Usage:* Sets which pointing device is active when you connect an external PS/2 pointing device to the computer.

(This option does not affect serial pointing devices.)

*Restart:* Y

**Option: PC Card Controller Mode**

*Settings:* PCIC Compatible  
CardBus/16bit (default)

*Usage:* Sets up the PC Card controller. This option affects all PC Card slots in the system, including any installed in an optional Desk Station V Plus or NoteDock II Enhanced Port Replicator. Set this option to CardBus/16bit only if you are using a PC Card that is CardBus compatible.

*Restart:* Y

## The Second Page

```

                                SYSTEM SETUP (2/2)                                BIOS version = x.xx
----- DISPLAY -----
VGA Segment Address = E400H-EFFFH

----- I/O PORTS -----
Serial                = COM1 (3F8H/IRQ4)
Built-in Modem       = COM2 (2F8H/IRQ3)
Parallel             = LPT1 (378H/IRQ7/CH3)
Sound                = Enabled

----- PCI BUS -----
PCI BUS              = IRQ Not Used

----- DRIVES I/O -----
Built-in HDD
= Primary IDE (1F0H/IRQ14)

----- FLOPPY DISK I/O -----
Floppy Disk = (3F2H/IRQ6/CH2)

↑↓←→: Select items   Space, Bksp: Change values   PgDn, PgUp: Change pages
Esc: Exit without saving   Home: Set default values   End: Save changes and Exit
```

*The second page of the System Setup screen*

### The DISPLAY Section

This section sets the memory address used by the display.

#### Option: VGA Segment Address

- Settings:* C000H-CBFFH  
E000H-EBFFH  
E000H-EFFFH  
E400H-EFFFH (default)

*Usage:* Lets you set the memory location for video BIOS. The default of E400 - EFFF uses 48KB of UMB (upper memory block) memory.

If your application is having video problems, try using the E000-EFFF setting.

*Restart:* Y

## The I/O PORTS Section

This section allows you to configure communications port settings for the serial and parallel ports.

### Option: Serial

*Settings:* COM1 (3F8H/IRQ4) (default)  
COM2 (2F8H/IRQ3)  
COM3 (3E8H/IRQ4)  
COM3 (3E8H/IRQ5)  
COM3 (3E8H/IRQ7)  
COM4 (2E8H/IRQ3)  
COM4 (2E8H/IRQ5)  
COM4 (2E8H/IRQ7)  
Not Used

*Usage:* Sets the serial port name through which your communications software sends output to the serial port. If your new setting conflicts with the setting for the modem, the port name for the conflicting port is changed to Not Used.

*Restart:* Y

### Option: Built-in Modem

*Settings:* COM1 (3F8H/IRQ4)  
COM2 (2F8H/IRQ3) (default)  
COM3 (3E8H/IRQ4)  
COM3 (3E8H/IRQ5)  
COM3 (3E8H/IRQ7)  
COM4 (2E8H/IRQ3)  
COM4 (2E8H/IRQ5)  
COM4 (2E8H/IRQ7)  
Not Used

*Usage:* Sets the COM port name your modem/fax and telephony software uses to send and receive information. If your new setting conflicts with the Serial Port setting, the conflicting port name is changed to Not Used.

*Restart:* Y

**Option: Parallel**

*Settings:* LPT1 (378H/IRQ7/CH3) (default)  
LPT2 (278H/IRQ5/CH3)  
LPT3 (3BCH/IRQ7/CH3)  
Not Used

*Usage:* Sets the parallel port name, address, interrupt and DMA channel through which the computer communicates with the parallel port.

*Restart:* Y

If you set the Parallel Port to anything other than Not Used, a drop-down list box appears offering a choice between ECP and Std. Bi-directional. If you choose ECP, you may also set the DMA channel. Set this to Std. Bi-directional if the documentation for your parallel device instructs you to do so, or you are having problems with your printer or other parallel device.

**Option: Sound**

*Settings:* Enabled (default)  
Not Used

*Usage:* Lets you turn the sound system on or off.

*Restart:* Y

The following sound system options are in a drop -down list box that appears when you highlight Enabled for the Sound System option.

**Option: WSS I/O Address**

*Settings:* 534H (default)  
608H  
E84H  
F44H

*Usage:* Lets you set a unique I/O address for the sound system when you are using it as Windows Sound System compatible.

*Restart:* Y

**Option: SBPro I/O Address**

*Settings:* 220H (default)  
240H

*Usage:* Lets you set a unique I/O address for the sound system when you are using it as SoundBlaster Pro compatible.

*Restart:* Y

**Option: Synthesizer I/O Address**

*Settings:* 388H  
Others (318H)

*Usage:* Displays the address used by the synthesizer.

*Restart:* N/A

**Option: WSS & SBPro IRQ Level**

*Settings:* IRQ5 (default)  
IRQ7  
IRQ9  
IRQ11  
IRQ15

*Usage:* Lets you set an IRQ level for the Windows Sound System/SoundBlaster Pro compatible mode of the sound system.

*Restart:* Y

**Option: WSS & SBPro DMA Playback**

*Settings:* Channel 0  
Channel 1 (default)  
Channel 3

*Usage:* Lets you set a DMA channel used for playback of the Windows Sound System/SoundBlaster Pro compatible sound file.

*Restart:* Y

**Option: WSS & SBPro DMA Record**

*Settings:* Channel 0 (default)  
Channel 1  
Channel 3

*Usage:* Lets you set a DMA channel used for recording of the Windows Sound System/SoundBlaster Pro compatible sound file.

*Restart:* Y

---



*If you set the WSS & SBPro Playback and WSS & SBPro Record options to the same channel, the Record option will display its setting as "same as playback," and full duplex will not be supported for speakerphone operation.*

---

**Option: Control I/O Address**

*Settings:* 120H

*Usage:* Displays the address used to control the sound device.

*Restart:* N/A

**Option: MPU401 (MIDI I/F)**

*Settings:* Not Used (default)  
330H/IRQ9  
330H/IRQ11  
330H/IRQ15  
330H/IRQ5  
330H/IRQ7

*Usage:* Enables the joystick port (on the NoteDock II Enhanced Port Replicator or Desk Station V Plus) to function with an external MIDI device.

This option is only visible when the computer is docked.

*Restart:* Y



---

## The PCI BUS Section

This section shows the interrupt level used by the optional Desk Station V Plus, when connected.

**Option: PCI BUS**

*Settings:* IRQ Not Used  
IRQ11 (typical)

*Usage:* This setting automatically defaults to IRQ11 under the following circumstances: 1) The computer is connected to an optional Desk Station V Plus. If IRQ11 is being used by an expansion card in the Desk Station V Plus, this IRQ level changes according to current resource availability. 2) The PC Card Controller Mode option is set to CardBus/16-bit.

If the computer isn't connected to a Desk Station V Plus, and the PC Card Controller Mode is set to PCIC Compatible, this option is set to IRQ Not Used.

*Restart:* N/A

## The DRIVES I/O Section

This section sets the memory range and interrupt level used by the system's hard disk and CD-ROM drives. Internal HDD refers to the built-in hard disk. Drives in the SelectBay are affected by the Int Selectable Bay option. The DS Selectable Bay option effects drives installed in the optional Desk Station V Plus SelectBay. The Selectable Bay options appear only if there is a drive installed in the SelectBay.

**Option: Built-in HDD**

*Settings:* Primary IDE (1F0H/IRQ14) (default)  
Not Used  
No Drive

*Usage:* Sets the I/O address and interrupt for the drive. Setting this option to Not Used disables the drive. If a drive is not installed, this option is automatically set to No Drive.

*Restart:* Y

**Option: Int Selectable Bay**

*Settings:* Secondary IDE (170H/IRQ15) (default)  
Not Used  
No Drive  
Others (1E8H/IRQ11)  
Others (168H/IRQ10)

*Usage:* Sets the I/O address and interrupt for a drive in the SelectBay. Setting this option to Not Used disables the drive. If a drive is not installed, this option is automatically set to No Drive.

*Restart:* Y

**Option: DS Selectable Bay**

*Settings:* Secondary IDE (190H/IRQ5) (default)  
Not Used  
No Drive  
Others (190H/IRQ10)

*Usage:* Sets the I/O address and interrupt for a drive in the Desk Station SelectBay. Setting this option to Not Used disables the drive. If a drive is not installed, this option is automatically set to No Drive.

*Restart:* Y

## The FLOPPY DISK I/O Section

This section sets the memory range and interrupt level used by the system's diskette drive.

**Option: Floppy Disk**

*Settings:* 3F2H/IRQ6/CH2 (default)  
No Drive

*Usage:* Displays diskette drive resource assignments. If the diskette drive is not connected to the system, this option is automatically set to No Drive.

*Restart:* N/A

# The Diagnostic Test

---

This chapter explains how to use the diagnostic test program TDIAGS.EXE to determine if your system components are working properly.

Use the diagnostic test if you have a problem you could not identify with the tips listed in the chapter “If Something Goes Wrong”. The test verifies that the following system components (hardware) are in working order:

- ❖ System (the computer's internal hardware)
- ❖ Memory
- ❖ Video
- ❖ Diskette drive
- ❖ Hard disk drive
- ❖ Printer (if you have one attached)

This chapter explains each of these tests in detail.

## Starting the Diagnostic Test

To test hardware, it's important to start the diagnostic test without optional features or programs (for example, without memory-resident programs). To do so, you should run TDIAGS from the Toshiba Companion Diskette using the Toshiba Companion Utility (even though the TDIAGS program is on the hard disk).

Before you start the test, check all cables for loose connections. If any errors occur during the test, check all cable connections again.

To run the diagnostic test, follow these steps:

**1 If you're using the diskette drive externally, make sure it's connected to the computer.**

**2 Put the Toshiba Companion Diskette in drive A and press Ctrl + Alt + Del.**

**3 From Windows 95, click Start, then click Shut Down.**

Windows 95 displays the Shut Down Windows dialog box.

**4 Click Restart the computer, then click Yes.**

Windows 95 shuts down the computer, then restarts it and displays a Welcome screen.

**5 Press Enter.**

The Toshiba Companion Utility loads the diagnostic test and displays its main menu:

Main Menu

Install Utilities and Files

View README Documents

Setup Your Computer

Run Diagnostics

Exit to DOS

- 6 Use the arrow keys to select **Run Diagnostics** and press Enter.

TDIAGS asks you to confirm that you want to run the diagnostic test.

- 7 To run the diagnostic test, press **Y (for yes)**, and press Enter.

The following sections explain the diagnostic test options.

## Choosing Test Options

Before the test begins, the program asks several questions about which components you wish to test.

- 1 The first question asks if you want to test the diskette drive(s). The computer displays:

Test the FDD (Y/N)?

- 2 To test the diskette drive(s), type **Y** and press Enter. To bypass the test, type **N** and press Enter.

The FDD (floppy disk drive) test tests the computer's diskette drive.

If you have installed the CD-ROM drive module in the Select-Bay, make sure you attach the diskette drive before performing this test.



*The test writes test patterns on any disk in the drive. These patterns destroy all information on the disk(s). Make sure there is no information you want to keep on the disk(s) you use.*

If you choose the FDD test, you must format and write enable these disks before the test. For 3 1/2-inch disks, move the write-protect tab to cover the square hole.

The next prompt asks if you want to test the hard disk drive:

Test the HDD (Y/N)?

- 3 To test the hard disk, type Y and press Enter. Otherwise, type N and press Enter.**



*The hard disk test overwrites a portion of the information stored on the disk. Back up any important files before you test the hard disk.*

---

The following prompt appears:

Test the printer (Y/N)?

- 4 Type Y to test the printer, or N to skip the test, and press Enter.**

Before beginning the test, make sure the printer is connected to the computer, the power is turned on, and the printer is on line.

If you chose to test the printer, the prompt displays:

Compatible with IBM printer (Y/N)?

- 5 To test an IBM® or an IBM-compatible printer, type Y and press Enter. To test a non-IBM-compatible printer, type N and press Enter.**

If you choose an IBM printer when your printer is not an IBM or IBM-compatible printer, the test output will be unintelligible and may cause the printer to eject multiple blank pages. If you're not sure about your printer's compatibility, type N for a non-IBM-compatible printer.

---

## Test Sequence

The diagnostic test checks the computer's components and printer in a predefined sequence as follows:

- ❖ System test
- ❖ Memory test
- ❖ Display test
- ❖ FDD (floppy disk drive or external diskette drive) test
- ❖ HDD (hard disk drive) test
- ❖ Printer test

While a test is in progress, the program displays:

```
IN PROGRESS TSSDSS
```

where *T* indicates the test number, the first *SS* indicates the subtest number, *D* indicates the drive (if tested), and the second *SS* indicates the hardware status. This message may remain on the screen for a moment. The following sections describe each subtest.

### System Functions and Memory

The system functions and the memory tests run together for approximately five seconds. The system functions test doesn't display any messages. The memory test displays the following message:

```
PROGRESS xxxxxx
```

where *xxxxxx* is the current memory location being tested. The memory test includes conventional and extended memory.

If either test aborts:

- 1 Write down everything that appears on the screen.**
- 2 Press Ctrl + Pause to return to the diagnostics menu.**
- 3 Consult your dealer.**



## Character Attributes

When the memory test completes, the diagnostic test displays the following screen:

```
CHARACTER ATTRIBUTES
NEXT LINE SHOWS NORMAL DISPLAY.
NNNNNNNNNNNNNNNNNNNNNNNNNNNNNN
NEXT LINE SHOWS INTENSIFIED DISPLAY.
IIIIIIIIIIIIIIIIIIIIIIIIIIIIII
NEXT LINE SHOWS REVERSE DISPLAY.
RRRRRRRRRRRRRRRRRRRRRRRRRRRRR
NEXT LINE SHOWS BLINKING DISPLAY.
BBBBBBBBBBBBBBBBBBBBBBBBBBBBBB

```

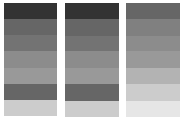

BLUE  
RED  
MAGENTA  
GREEN  
CYAN  
YELLOW  
WHITE

Press [Enter] key

*Character attributes test screen*

Look under the message NEXT LINE SHOWS BLINKING DISPLAY to make sure the line is actually blinking.

If your screen doesn't match the diagnostic test display, write down the differences and contact your dealer. If your screen matches the display, press Enter to go to the next test.

## 320 X 200 Graphic Display

The next test is the 320 x 200 GRAPHIC DISPLAY (13) test. The test screen displays 16 colored horizontal bars with the name of the color.

Go to the next test by pressing Enter.

## Character Sets

The next two tests are character set tests. The first checks that the screen can display characters in a 40 column by 25 row format (the characters are wider than normal).



## Graphics Capabilities

The next subtests check the screen's graphic capabilities for each of the computer's graphics modes.

During the test, the resolution and mode number appear above an image representing the mode's capabilities. The number inside the brackets is the mode number.

The next illustration shows the test image for one of the 320 x 200 graphics modes (mode 4).

**320\*200 GRAPHICS DISPLAY : [ 4 ]**



**PRESS [ENTER] KEY**

*Graphics capabilities test screen*

A similar screen appears for each of the computer's graphics modes.

Press Enter to proceed with the next screens, which differ primarily in resolution. Make a note of any screen which doesn't appear correct and contact your dealer. Press Enter to go to the next test.

## Testing the Diskette Drive

If you selected the diskette drive test, you see a prompt that asks you to insert a disk into each drive you want to test.

---

Insert a formatted, write-enabled diskette into each drive(s).

---



*This test may destroy all information on the diskettes. Make sure there is no information you want to keep on the diskettes you use.*

---

To skip this test and return to the diagnostics menu, press Ctrl + Pause.

After you insert the diskette(s) in the drive(s), press Enter. The test begins and displays this message:

FLOPPY DISK IN PROGRESS 503000

If an error occurs, the test displays the ABORTED message. Write down the highlighted numbers and return to the main menu by pressing Ctrl + Pause.

If a diskette drive fails the test, check the following:

- ❖ Does the drive contain a diskette?
- ❖ Is the diskette properly formatted?
- ❖ Is the diskette write-enabled?
- ❖ Is the diskette undamaged?

Repeat the test with another diskette. If the test displays the ABORTED message again, see your dealer.

If the test completes successfully, and you selected the hard disk test, the diagnostic test begins checking the hard disk. If you did not select the hard disk or printer test, the diskette drive test concludes by displaying the TDIAGS screen. To exit TDIAGS, go to “Exiting the Diagnostic Menus” on page 460.

## Testing the Hard Disk

If the diskette drive(s) test is successful and you selected the hard disk drive test, the hard disk test briefly displays this message:

HARD DISK TEST IN PROGRESS 805100

If an error occurs, the test displays the ABORTED message. Write down all messages and highlighted numbers and consult your dealer. Your computer or your drive may need service. To return to the main menu, press Enter.



*The hard disk test does not destroy all of the information stored on the hard disk. However, this test overwrites a small portion of the disk. Back up any important files before you test the hard disk.*

---

If the test completes successfully, and you selected the printer test, the diagnostic test begins the printer test. If you did not select the printer test, the hard disk test concludes by displaying the TDIAGS screen. To exit TDIAGS, go to “Exiting the Diagnostic Menu” on page 460.

## Testing the Printer

If the hard disk drive tests successfully and you selected to test the printer, the printer test displays this message:

PRINTER TEST IN PROGRESS 60xxxx



Run the test. If the test displays the ABORTED message again, or your printout doesn't match the output shown in the illustrations, consult your dealer to have the printer and the cable serviced.

If the printer tests successfully, the test displays the COMPLETED message. Press Enter to return to the TDIAGS screen. To exit TDIAGS, continue with the next section.

## Exiting the Diagnostic Menus

To exit the diagnostic menu, follow these steps:

- 1 When TDIAGS completes system components testing, type N and press Enter.**

TDIAGS returns you to the Main menu.

- 2 Remove the Toshiba Companion Diskette from the diskette drive and press Ctrl + Alt + Del or the reset button to restart the computer.**

The computer restarts.





# Features and Specifications

---

This appendix lists the features of the computer and summarizes its specifications.

## Built-in Features

This section lists the computer's features.

### Technology and Processor

Microprocessor	166MHz, 2.5V/3.3V Intel Pentium processor with MMX and internal math coprocessor
LSI and CMOS	Large scale integrated and complementary metal-oxide semiconductor technology, providing minimum size and weight, low power usage and high reliability
L2 cache	256KB external write-through level two cache 1Mbit Pipelined Burst Synchronous SRAM (32K x 32bit, 3.3V) x 2, 8ns access time (15ns cycle time w/ 66MHz speed)

PCI Bus	High performance PCI system bus supports external PCI docking capability
Zoomed Video support	Supports Zoomed Video (ZV) PC Cards, allowing advanced multimedia capabilities, such as video conferencing, on-screen television and video play-back. ZV PC Cards require CardWorks Card and Socket Services software, which is provided on your computer
CardBus support	Supports CardBus PC Cards, enabling connection to high-speed peripherals used for multimedia communications and fast Ethernet
Memory	3.3-volt 64 bit bus, EDO (Extended Data Output) DRAM (Dynamic Random Access Memory), delivers high performance with a 60 nanosecond (ns) access time
Video Graphics Controller	Chips and Technologies B65554 SVGA display controller with 32bit PCI local bus, VESA Extended VGA BIOS (including VBE/PM/DPMS), supports high-resolution, high-color video modes listed in Appendix D “Video Modes” on page 487
ECP	The parallel port is an IEEE P1248 8-bit Enhanced Capability Port (ECP-compliant port), providing increased performance when you’re using an ECP-compatible parallel device

### Power

Computer	40 watt AC power adapter, 100-240V universal input voltage, 50/60Hz frequency, 15V, 2.7 amp maximum output voltage
Main Battery	Removable, rechargeable 3.6V x 2,800mAh Li-Ion battery pack

---

Backup Battery	7.2v x 30mAh Nickel-metal hydride (NiMH) battery provides power for special memory features, such as Resume Mode
RTC battery	3.6v x 30mAh NiMH battery provides power for the internal real time clock and calendar
Intelligent power supply	Detects low battery charge and displays the battery charge remaining
Automatic power off	Saves battery power by automatically turning off the display and hard disk when either have not been accessed for a set length of time

### Storage Capacity

3.5-inch diskette drive module	Accommodates both 1.44MB, high density (2HD) and 720KB, double-density (2DD) diskettes
CD-ROM drive module	5.25-inch 10X* speed, MPC-compliant, photo-CD capable CD-ROM drive module lets you run programs from CD-ROMs (compact discs)
Hard disk	2.5-inch integrated drive and controller provides non-volatile storage for 2.1 billion bytes (2.02GB)

\*10X average

### Ports

Modem/fax (RJ-11) port	RJ-11 jack lets you connect the internal modem directly to a telephone line
Parallel	Selectable, ECP-compatible parallel port that provides a Centronics-compatible connection to a printer or other parallel output or bi-directional device

Serial	9-pin, RS-232-C-compatible, high speed, buffered serial port lets you connect an external modem, mouse, serial printer or other serial device
Monitor	15-pin, analog VGA port lets you connect an external SVGA monitor (color or monochrome)
PS/2 mouse/keyboard	PS/2-compatible port allows you to connect a PS/2 keyboard or mouse
Expansion port	240-pin port lets you connect an optional Desk Station V Plus or NoteDock II Enhanced Port Replicator
External diskette drive port	Lets you connect the external 3 1/2-inch diskette drive, if you've removed it to install the CD-ROM drive module
Infrared port	Infrared Data Association (IrDA)-compliant serial infrared port enables 115.2 Kbps cableless data transfer with IrDA 1.1 compatible external devices
Microphone jack	3.5 mm stereo jack lets you connect an external monaural microphone or other audio input device
Headphone jack	3.5 mm stereo jack lets you connect stereo headphones or other audio output device, such as external speakers
Line-in jack	3.5 mm mini line-in stereo jack lets you connect an external stereo device for audio input
Line-out jack	3.5 mm mini line-out stereo jack lets you connect an external stereo device for audio output

---

## Standard Hardware

Memory	16MB, 3.3 volt, 64 bit bus EDO DRAM
Display	The Tecra 740CDT has an 13.3-inch (measured diagonally) active matrix Thin Film Transistor (TFT) color LCD that displays up to 64K colors simultaneously at 1024 x 768 resolution
Telecommunications	<p>Integrated 28.8 Kbps V.34 data/v.17 modem/fax</p> <p>Integrated speaker phone and answering machine capabilities through Multimedia Connect software</p> <p>The modem supports the V.80 protocol, which allows you to use the Noteworthy Business Video Phone with Intel ProShare Technology (provided with your computer).</p> <p>The data modem supports the following protocols: Bell-103/212A; CCITT-V.21/V.22, V.23, V.22bis protocols with data from 300 to 2400 bps; CCITT-V.32 protocols with data rates of 4800 and 9600 bps; CCITT=V.21bis protocols with data rates of 4800, 7200, 9600, 12000, and 14400 bps; CCITT-V.32 terbo protocols with data rates of 16800 and 19200 bps; CCITT-V.34 protocols with data rates from 2400 bps to 28800 bps; Error correction via MicroCom Network Protocol classes 1-4; MNP class 5 for up to 2x data compression; CCITT-V.42bis for up to 4x data compression</p> <p>The fax modem supports the following protocols: V.21 ch2 - 300 bps send/receive; V.27ter - 2400/4800 bps send receive; V.29 - 7200/9600 bps send/receive; V.17 = 12000/14400 bps send/receive; Fax Class 1; Class 1 ECM (High Speed HDLC, ECM capability)</p>

## 470 Features and Specifications

*Built-in Features*

---

Keyboard	Enhanced 82-key (84-key in Europe) keyboard emulates the IBM PS/2 keyboard and includes embedded numeric and cursor control overlays and dedicated cursor control keys
Sound	Crystal Semiconductor CS4232, Yamaha OPL3 (YMF262), and Yamaha D/A converter (YAC512) compatible with Windows Sound System and SoundBlaster Pro
AccuPoint and buttons	Provides the complete function of a mouse or other pointing device from within the keyboard
Earclips	Koss SportClip earclips let you experience your computer's sound capabilities without disturbing those near you
Noteworthy Business Video Phone with Intel ProShare Technology	Video conferencing kit includes: Noteworthy Color Camera, camera stand, mounting clip, video cable, AC power adapter, and the Noteworthy Video Conferencing CardBus Card

### Standard Software

Operating System	Windows 95 (default)
Configuration Programs	The MaxTime Control Panel, Toshiba System Control Panel and TSETUP let you change configuration options and set preferences
Power	APM and the MaxTime Control Panel monitor the battery charge and provide access to the power-saving features

---

Telephony	Multimedia Connect provides speaker phone, fax, and voice mail capabilities in Windows 95 and Windows 3.11
Video Conferencing	Noteworthy® Business Video Phone with Intel® ProShare® Technology

## Special Features

Resume Mode	Electronic bookmark that records what you're doing when you turn the computer off and returns you to the same place when you turn the power back on
Advanced Power Management	Lets you set power consumption levels through the MaxTime Control Panel or TSETUP
Security	Instant, power-on and hard disk passwords help protect your files

## Documentation

User's Guide	Explains how to set up the computer, gives instructions for basic computing tasks and documents all system components and features
Electronic Guide	Provides the <i>User's Guide</i> in hypertext form Load this guide into memory and refer to it when you have questions about the computer
Microsoft Windows 95 documentation	Documents the Windows 95 operating system

## Optional Accessories and Devices

This section lists the options available for the computer.

### Power Devices

Battery charger	Charges extra battery packs
Additional battery packs	Use as spare or replacement packs to extend the time you can operate the computer away from a live wall outlet

### Memory Modules

8MB	Expands the computer's memory to 24MB
16MB	Expands the computer's memory to 32MB
32MB	Expands the computer's memory to 48MB
64MB	Expands the computer's memory to 80MB
128MB	Expands the computer's memory to 144MB

### Expansion Capability

PC Card slot	Lets you install one Type III or up to two Type I or Type II PC cards. These slots support Zoomed Video Card and CardBus cards. Maximum slot thickness: 10.5 mm
--------------	--



---

Desk Station V Plus	Optional docking station that provides access to the following: built-in AMD SCSI controller, internal IDE connector, two Type III PC Card slots, slots for ISA or PCI expansion cards, drive bay for an extra half-height 5 1/4" drive, SelectBay for diskette drive, CD-ROM drive module or hard drive module, headphone jack, microphone jack, PS/2 mouse port, PS/2 keyboard port, audio line-in jack, audio line-out jack, serial port, video port, parallel port, MIDI/joystick port, AC in and security lock slot
NoteDock II Enhanced Port Replicator	Optional docking station that provides access to the following: two Type II PC Card slots, serial port, parallel port, video port, PS/2 mouse port, PS/2 keyboard port, microphone jack, headphone jack, audio line-in jack, audio line-out jack, MIDI/joystick port, AC in and security lock slot

## Others

Carrying case	Sturdy fabric or leather carrying case protects the computer while traveling
---------------	--

## Security

Cable	Noteworthy Computer Lock cable to deter computer theft
-------	--

## Specifications

### Physical Dimensions

Weight	8.45 lbs (3.9kg) with diskette drive module 8.7 lbs (4.1kg) with CD-ROM drive module
Size	<i>width x depth x height</i> 11.95 inches x 9.41 inches x 2.40 inches (303.6mm x 239mm x 61mm)

### Environmental Conditions

	<i>Operating</i>	<i>Non-operating</i>
<i>Temperature</i>	5°C (41°F) to 35°C (95°F)	-20°C (-4°F) to 65°C (149°F)
<i>Relative Humidity</i>	20% to 80% non-condensing	10% to 90% non-condensing
<i>Altitude (relative to sea level)</i>	-60 to 3,000 m	-60 to 10,000 m
<i>Shock</i>	10G; 1.5G with CD-ROM drive installed	60G; 50G with CD-ROM drive installed
<i>Vibration</i>	0.5G; 0.25G with CD-ROM drive installed	1G; 1G with CD-ROM drive installed



# Power Cord Connectors

---

The computer features a universal power supply you can use worldwide. This appendix shows the shapes of the typical AC power cord connectors for various parts of the world.

## USA and Canada

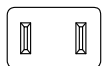

UL approved  
CSA approved

## United Kingdom



BS approved

## Australia



AS approved

## Europe



VDA approved  
NEMKO approved

# System Resources

---

This appendix lists the IRQ levels, DMA channels and I/O port addresses.

## IRQ Level Assignments

The direct line to the CPU is called an Interrupt ReQuest (IRQ) level or channel. You'll hear both terms used by technical experts. They mean the same thing. The following table lists the default IRQ level assignments for the computer:

<i>IRQ</i>	<i>Use</i>	<i>Notes</i>
0	Timer	
1	Keyboard	
2	PIC #2	
3	Modem	Choice for main hard disk, CD-ROM, secondary hard disk, COM port, serial infrared port, PC Card, modem, FIR

<i>IRQ</i>	<i>Use</i>	<i>Notes</i>
4	COM	Choice for main hard disk, CD-ROM, secondary hard disk, COM port, serial infrared port, PC Card, modem, FIR
5	Sound System	Choice for main hard disk, CD-ROM, secondary hard disk, COM port, serial infrared port, printer, PC Card, modem, ECP, FIR, MPU*
6	3 1/2-inch diskette drive	
7	LPT1	Choice for main hard disk, CD-ROM, secondary hard disk, COM port, serial infrared port, PC Card, modem, ECP, sound system, FIR, MPU*
8	Real-time clock	
9	Available	Choice for main hard disk, CD-ROM, secondary hard disk, COM port, serial infrared port, sound system, PC Card, FIR, MPU*
10	Available	Choice for main hard disk, CD-ROM, secondary hard disk, COM port, serial infrared port, PC Card, FIR
11	External PCI Bus	Choice for main hard disk, CD-ROM, secondary hard disk, COM port, serial infrared port, PC Card, sound system, FIR, MPU*
12	PS/2 Mouse	
13	Math Coprocessor	

---

<i>IRQ</i>	<i>Use</i>	<i>Notes</i>
14	Hard disk	Choice for CD-ROM, secondary hard disk, COM port, serial infrared port, PC Card, FIR
15	CD-ROM	Choice for main hard disk, secondary hard disk, COM port, serial infrared port, PC Card, sound system, FIR, MPU*

\*MPU401 in Desk Station V Plus, if available.

## DMA Channel Assignments

Direct Memory Access (DMA) allows some devices to transfer data to and from memory at high speeds, without using the CPU. Such devices are each assigned a unique DMA channel. The computer has two DMA controllers with four channels on each controller, a total of eight DMA channels.

The following table lists the computer's DMA channel assignments.

<i>DMA</i>	<i>Use</i>	<i>Notes</i>
0	Sound System	Choice for Sound System
1	Sound System	Choice for ECP
2	3 1/2-inch diskette drive	Choice for ECP
3	ECP	Choice for Sound System
4	Cascade from DMAC 1	
5	Reserved	FIR
6	Reserved	FIR
7	Reserved	FIR

## Input/Output Port Address Assignments

The CPU accesses input/output devices, such as modems, by reading from them or writing to them. Each command to read or write must specify the address (in memory) for the port. Each device that communicates with the CPU must have a unique I/O port address.

The following table lists the device names and their assigned I/O port addresses for the computer.

<i>Port address(h)</i>	<i>Device/function</i>	<i>Notes</i>
000-01F	82C37: DMA Controller 1	
020-03F	82C59: PIC 1	
040-05F	82C54: Timer	
060-06F	Keyboard Controller	060 and 064 are KBC 061 is system status port
070	NMI mask register	
070-07F	Real Time Clock	
080-09F	DMA page register	
0A0-0BF	82C59: PIC 2	
0C0-0DF	82C37: DMA Controller 2	
0E0-0E1	PCI Bus	
0F0-0F7	Math Coprocessor	
100-1EF	VGA	
170-177	CD-ROM (Secondary IDE Controller)	



---

<i>Port address(h)</i>	<i>Device/function</i>	<i>Notes</i>
1F0-1FF	Hard Disk Controller (Primary IDE Controller)	
200	Joy Stick	
202-21F	Not used	
220-22F	Not used	SoundBlaster Pro
240-24F	Not used	Available for Sound System
260-277	Not used	
278-27F	Parallel PRT 2	
280-2E7	Not used	
2E8-2EF	Serial Port, Infrared Port, or Built-In Modem (COM4)	
2F0-2F7	Not used	
2F8-2FF	Serial Port, Infrared Port, or Built-In Modem (COM2)	
300-33F	Not used	
340-35F	Not used	
360-375	Not used	
376-377	Not used	Secondary IDE Controller
378-37F	Parallel PRT 1	
380-387	Not used	
388-38B	Sound System OPL3 (MIDI)	
38C-38F	Not used	

## 484 System Resources

### *Input/Output Port Address Assignments*

---

<i>Port address(h)</i>	<i>Device/function</i>	<i>Notes</i>
390-39F	Not used	
3A0-3AF	Bisynchronous 1	
3BC-3BE	Parallel PRT 3	
3C0-3DF	CGA, EGA, VGA	
3E2-3E3	Secondary PCMCIA Controller when docked (only in PCIC mode)	
3E8-3EF	Serial Port, Infrared Port, or Built-In Modem (COM3)	
3F0-3F7	3 1/2-inch diskette drive controller	I/O ports 3F6 and 3F7 are used for the HDC also
3F8-3FF	Serial Port, Infrared Port, or Built-In Modem (COM1)	
400-47F	Not used	
480-49F	DMA High-Page Register	
530-537	Windows Sound System	
604-60B	Not used	Available for Windows Sound System
E80-E87	Not used	Available for Windows Sound System
F44-F47	Not used	Available for Windows Sound System



# Video Modes

---

This appendix lists the video modes supported by the display adapter, and identifies the characteristics of each mode.

The columns of the following tables are defined as follows:

*Mode* is the mode number in hexadecimal, and is generally used by programmers to specify video modes in programs.

*Type* identifies the display adapter that first supported the mode, and specifies whether the mode is text or graphics.

*Resolution* is the measure of the screen's dimensions in terms of horizontal and vertical pixels (in graphics modes), or rows and columns of characters (in text modes).

*Grid* is the default number of pels per character.

*LCD Colors* is the maximum number of simultaneous colors, or shades of gray, that the mode can display on the built-in screen.

*CRT Colors* is the maximum number of simultaneous colors, or shades of gray, that the mode can display on an external monitor.

*Scan Freq hor/vert* is the horizontal and vertical scanning frequency in Hertz. This is for external monitors only.

# 488 Video Modes

This table lists the video modes for the Tecra 740CDT computer:

Mode (hex)	Type	Resolution	Internal LCD		External Monitor		Scan Freq hor/vert
			Grid (pelxpel)	Colors	Grid (pelxpel)	Colors	
0, 1	VGA Text	40 x 25 char	8 x 8	16/256K	8 x 8	16/256K	31.5KHz/70Hz
2, 3	VGA Text	80 x 25 char	8 x 8	16/256K	8 x 8	16/256K	31.5KHz/70Hz
0*, 1*	VGA Text	40 x 25 char	8 x 14	16/256K	8 x 14	16/256K	31.5KHz/70Hz
2*, 3*	VGA Text	80 x 25 char	8 x 14	16/256K	8 x 14	16/256K	31.5KHz/70Hz
0+, 1+	VGA Text	40 x 25 char	8 x 16	16/256K	9 x 16	16/256K	31.5KHz/70Hz
2+, 3+	VGA Text	80 x 25 char	8d x 16	16/256K	9 x 16	16/256K	31.5KHz/70Hz
4, 5	VGA Graph	320 x 200 pels	8 x 8	4/256K	8 x 8	4/256K	31.5KHz/70Hz
6	VGA Graph	640 x 200 pels	8 x 8	2/256K	8 x 8	2/256K	31.5KHz/70Hz
7	VGA Text	80 x 25 char	8 x 14	Mono	9 x 14	Mono	31.5KHz/70Hz
7+	VGA Text	80 x 25 char	8 x 16	Mono	9 x 16	Mono	31.5KHz/70Hz
D	VGA Graph	320 x 200 pels	8 x 8	16/256K	8 x 8	16/256K	31.5KHz/70Hz
E	VGA Graph	640 x 200 pels	8 x 8	16/256K	8 x 8	16/256K	31.5KHz/70Hz
F	VGA Graph	640 x 350 pels	8 x 14	Mono	8 x 14	Mono	31.5KHz/70Hz
10	VGA Graph	640 x 350 pels	8 x 14	16/256K	8 x 14	16/256K	31.5KHz/70Hz
11	VGA Graph	640 x 480 pels	8 x 16	2/256K	8 x 16	2/256K	31.5KHz/60Hz
12	VGA Graph	640 x 480 pels	8 x 16	16/256K	8 x 16	16/256K	31.5KHz/60Hz
13	VGA Graph	320 x 200 pels	8 x 8	256/256K	8 x 8	256/256K	31.5KHz/70Hz
20	SVGA Graph	640 x 480 pels	8 x 16	16/256K	8 x 16	16/256K	31.5KHz/60Hz 37.6KHz/75Hz 43.2KHz/85Hz
22	SVGA Graph	800 x 600 pels	8 x 8	16/256K	8 x 8	16/256K	37.9KHz/60Hz 46.9KHz/75Hz 53.7KHz/85Hz
24	SVGA Graph	1024 x 768 pels	8 x 16	16/256K	8 x 16	16/256K	35.5KHz/ 87Hz* 48.5KHz/60Hz 60.0KHz/75Hz 68.8KHz/85Hz
28	SVGA Graph	1280 x 1024 pels	8 x 16	16/256K (virtual)	8 x 16	16/256K	35.5KHz/ 87Hz* 35.5KHz/60Hz
30	SVGA Graph	640 x 480 pels	8 x 16	256/256K	8 x 16	256/256K	31.5KHz/60Hz 37.6KHz/75Hz 43.2KHz/85Hz

Mode (hex)	Type	Resolution	Internal LCD		External Monitor		Scan Freq hor/vert
			Grid (pelxpel)	Colors	Grid (pelxpel)	Colors	
32	SVGA Graph	800 x 600 pels	8 x 16	256/256K	8 x 16	256/256K	37.9KHz/60Hz 46.9KHz/75Hz 53.7KHz/85Hz
34	SVGA Graph	1024 x 768 pels	8 x 16	256/256K	8 x 16	256/256K	35.5KHz/ 87Hz* 48.5KHz/60Hz 60.0KHz/75Hz 68.8KHz/85Hz
38	SVGA Graph	1280 x 1024 pels	8 x 16	256/256K (virtual)	8 x 16	256/256K	35.5KHz/ 87Hz* 35.5KHz/60Hz
40	SVGA Graph	640 x 480 pels	8 x 16	32K/32K	8 x 16	32K/32K	31.5KHz/60Hz 37.6KHz/75Hz 43.2KHz/85Hz
41	SVGA Graph	640 x 480 pels	8 x 16	64K/64K	8 x 16	64K/64K	31.5KHz/60Hz 37.6KHz/75Hz 43.2KHz/85Hz
42	SVGA Graph	800 x 600 pels	8 x 16	32K/32K	8 x 16	32K/32K	37.9KHz/60Hz 46.9KHz/75Hz 53.7KHz/85Hz
43	SVGA Graph	800 x 600 pels	8 x 16	64K/64K	8 x 16	64K/64K	37.9KHz/60Hz 46.9KHz/75Hz 53.7KHz/85Hz
44	SVGA Graph	1024 x 768 pels	8 x 16	32K/32K	8 x 16	32K/32K	48.5KHz/60Hz
45	SVGA Graph	1024 x 768 pels	8 x 16	64K/64K	8 x 16	64K/64K	48.5KHz/60Hz
50	SVGA Graph	640 x 480 pels	8 x 16	N/A	8 x 16	16M/16M	31.5KHz/60Hz
52	SVGA Graph	800 x 600 pels	8 x 16	N/A	8 x 16	16M/16M	37.9KHz/60Hz

\* These modes are interlaced. All others are non-interlaced.

# Using Windows for Workgroups

---

If you selected Windows for Workgroups when you first started your computer, you may be wondering how much of this guide is relevant to you. In fact, many of the instructions for Windows 95 procedures are very similar to those you use in Windows for Workgroups.

This appendix tells you how to carry out the procedures described in this guide if you're using Windows for Workgroups.

## Introducing Windows for Workgroups

This section gives a brief introduction to Windows for Workgroups. For more information, click Help, then click Contents to access the on-line help.

## Starting Windows for Workgroups

When you turn your computer on it loads the MS-DOS operating system and displays the command prompt (for example, C:\>). To start Windows for Workgroups, type c:\windows\win and press Enter.

Windows for Workgroups loads and displays the Program Manager window.

## What's on the Screen?

Program Manager is the gateway to your programs and all the other features of Windows for Workgroups. This section describes the features of Program Manager. Many of these features, such as the menu bar and minimize button, are also present in other programs you run under Windows for Workgroups.

When you start Windows for Workgroups, you see a screen similar to the following:

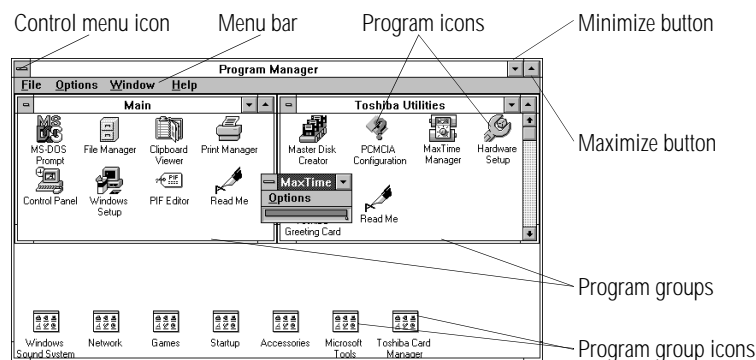

*The Program Manager window*

- ❖ Clicking the **control menu icon** opens the control menu. This menu lets you set features such as the size and shape of the current window. Double-clicking this icon closes the current window.
- ❖ Clicking one of the words on the **menu bar** opens a list of related activities.



- ❖ Clicking the **minimize button** reduces the current window to an icon. The program in the window is still running—it has just moved out of the way to make room for other windows.
- ❖ Clicking the **maximize button** expands the current window to take up the entire screen. When a program is maximized, the maximize button changes to a double arrow called the restore button. Click the restore button to return the window to its original size.
- ❖ Double-clicking a **program icon** starts the program represented by the icon.
- ❖ **Program groups** contain one or more icons representing related programs. For example, the Toshiba Utilities program group contains Toshiba programs, such as MaxTime and Hardware Setup.
- ❖ Double-clicking a **program group icon** opens the program group represented by the icon.

There is no close button in Windows for Workgroups.

## Starting Programs

To start a program in Windows for Workgroups, double-click its icon in Program Manager.

If the program doesn't have a Program Manager icon, you have the following two choices:

- ❖ In Program Manager, click File, then click Run. Type in the name of your program file or click Browse to locate the program file, then click OK.
- ❖ In File Manager, double-click the icon for the program file. See the next section for information about File Manager.

## Working with Files

You use File Manager to copy and move files, and to perform other file operations in Windows for Workgroups. To start File Manager, double-click the File Manager icon in Program Manager's Main program group.

For information about using File Manager, click Help, then click Contents. Type in the subject you wish to explore, or browse through the list of topics provided.

## Running Programs Described in the Guide

This guide describes a number of programs that come with your computer. Using these programs under Windows for Workgroups is almost the same as using them under Windows 95. This section lists each of the programs, describes the differences between the Windows 95 and Windows for Workgroups versions and points to the instructions for using them.

### Master Disk Creator

Master Disk Creator works as described in "Running Master Disk Creator" on page 39, with the following exceptions:

- ❖ Master Disk Creator also creates program disks for Windows for Workgroups. There is no Windows for Workgroups equivalent for Microsoft's Windows 95 Create System Disks program.
- ❖ To start Master Disk Creator, go into Program Manager and double-click the Master Disk Creator icon in the Toshiba Utilities program group.

---

## MaxTime

MaxTime opens automatically each time you start Windows for Workgroups. If MaxTime is not already open, go into Program Manager and double-click the MaxTime icon in the Toshiba Utilities program group.

MaxTime controls your system's power-saving options. These options are also available through TSETUP. For information about what each option does, read "TSETUP" on page 427.

## Hardware Setup

To start Hardware Setup, go into Program Manager and double-click the Hardware Setup icon in the Toshiba Utilities program group.

Use Hardware Setup to control your hardware configuration. These options are also available through TSETUP. For information about what each option does, read "TSETUP" on page 427.

## The TSETUP Program

To open TSETUP, follow these steps:

- 1 Close any programs you are running and exit Windows, if it's open.**



*Run TSETUP outside of Windows, at a system prompt. If you run TSETUP from an MS-DOS session under Windows by clicking the MS-DOS prompt icon, results can be unpredictable.*

---

- 2 At the system prompt, type `c:\dos\tsetup` and press Enter.**

Once you've opened TSETUP, it operates as described in "TSETUP" on page 427.

## Fn-esse

To open Fn-esse, go into Program Manager and double-click the Fn-esse icon in the Toshiba Utilities program group. Once you've opened Fn-esse, it operates as described in "Starting Programs Faster with Fn-esse" on page 292.

## Turning the Power Off

This section describes how to turn the computer off correctly.

## Using Resume Mode in Windows for Workgroups

This guide describes two ways you can turn the computer off and return to the same place in your work when you turn it on again: the Suspend Command and Resume Mode. The Suspend Command is a feature of Windows 95. With Windows for Workgroups you must use Resume mode instead. You can turn Resume Mode using MaxTime, a hotkey or TSETUP.

## Turning the Computer Off

When you're ready to turn the computer off, assuming Resume Mode isn't turned on, follow these steps:

- 1 Save your files and close any programs you're using.**
- 2 In Program Manager, press Alt + F4 to exit Windows.**
- 3 Wait for MS-DOS to display the command prompt.**



*Always wait until you see the command prompt before you turn the computer off. You may get unpredictable results the next time you start Windows if you don't let it shut down completely.*

---

- 4 Turn the computer off.**

---

## Using Optional Devices in Windows for Workgroups

Windows for Workgroups does not support the plug-and-play standard described for Windows 95. This means that when you connect an optional device, such as a PC Card, you'll have to set it up yourself. This section provides information you'll need for using optional devices with Windows for Workgroups.

### Using PC Cards

The CardSoft Card and Socket Services programs that came pre-installed on your computer provide PC Card support in Windows for Workgroups. See the CardSoft documentation for instructions for setting up PC Card support.



*The CardSoft programs were specifically designed for your Toshiba computer. Even if your PC Card comes with its own Card and Socket Services programs, try CardSoft first.*

---

### Setting Up PC Card Support in Windows for Workgroups

Your Tecra 740CDT came with the PC Card Controller Mode option set to CardBus/16bit. Before you can use PC Cards in Windows for Workgroups, you'll need to set this mode (in TSETUP or Hardware Setup) to PCIC Compatible. To change the PC Card Controller Mode and start using your PC Cards, follow these steps:

- 1 Exit any programs you are running and close Windows.**
- 2 At the system prompt, type `c:\dos\tsetup` and press Enter.**  
TSETUP displays the first page of the System Setup screen.
- 3 Use the cursor keys to move the cursor to the PC Card Controller Mode option.**

- 4 Press the spacebar to change the option setting to PCIC Compatible.**
- 5 Press End to save your change and exit TSETUP.**  
The system shuts down and restarts.
- 6 Type win and press Enter to start Windows for Workgroups.**
- 7 Insert your PC Card into one of the computer's PC Card slots, following the instructions in "Inserting PC Cards" on page 198.**  
CardSoft detects your card automatically and displays a wizard screen.
- 8 Follow the instructions on the screen to configure the card.**

### Using CardBus Cards

Windows for Workgroups and CardSoft do not support CardBus PC Cards. Before you can use a CardBus PC Card, you'll need to:

- ❖ Install an additional driver (called an enabler). Refer to the documentation provided with your PC Card for instructions.
- ❖ Change the PC Card Controller Mode to CardBus/16bit. To do this, complete steps 1 through 6 in the previous section, "Setting Up PC Card Support in Windows for Workgroups," selecting CardBus/16bit as the PC Card Controller Mode (instead of PCIC Compatible).



NOTE

*The Video Conferencing CardBus Card and Intel ProShare software, provided with your computer, are specifically designed to work with Windows 95. You cannot use the video conferencing package in Windows for Workgroups.*

---

## Resolving Resource Conflicts

If you add a device that uses the resources already assigned to another device, your system stops working and you must resolve the resource conflict.

Make a list of all the resources used by your optional devices. The documentation for each device will tell you how to determine these.

Once your list is complete, check it against the lists in “System Resources” on page 479. Make sure that none of your optional devices conflicts with the preset system assignments.

If you can't locate the source of the conflict, remove all optional devices and add them one at a time. Each time you add a device check to see if the conflict reappears.

## Getting Help with Windows for Workgroups

Your computer comes with an electronic book that documents Windows for Workgroups. It is called *Windows QuickStart 3.11 Edition*. To open this book, follow these steps:

- 1 Open the Toshiba Utilities program group.**
- 2 Double-click the Windows QuickStart 3.11 Edition icon.**

Windows opens the book at the table of contents.

## Reading a Selected Topic

To read a section of the *Windows QuickStart 3.11 Edition*:

- ❖ Select a part of the book, click its index tab or click Contents and select the section from the list displayed.
- ❖ To move to the beginning of the table of contents, click Contents.
- ❖ To move up or down in a section, click and drag the scroll box or click the up and down arrows at the right side of the screen.

- ❖ To move forward or backward one section at a time, click the left and right arrow icons at the bottom of the screen.
- ❖ To use the alphabetical index, click Index and click on a topic name.
- ❖ To get help, choose Help Contents from the Help menu or press F1.

## Placing Bookmarks

Just as you would with a printed book, you can mark your place with a bookmark.

### Defining a New Bookmark

To define (or create) a bookmark, follow these steps:

- 1 Position the pointer at the beginning of the text you want to find again.**
- 2 Choose Define from the Bookmark menu, or click the yellow bookmark icon in the lower-right corner of the screen.**

The dialog box automatically shows the current chapter in the Bookmark Name field as the default name, and displays a list of currently defined bookmarks.

- 3 Type in a name for your bookmark and click OK.**

If you click OK without typing a name, the current chapter name becomes the bookmark.

If the name is already assigned to another bookmark, the program displays a message. Type in a new bookmark name and click OK.



The electronic book program creates a consecutively numbered bookmark and places it in the text at the upper edge of the “book.”

To view a marked section, click its assigned bookmark and the program switches to the corresponding text location.

## Removing a Bookmark

To remove a previously defined bookmark, follow these steps:

- 1 Choose Define from the Bookmark menu or click the yellow bookmark icon in the lower-right corner of the screen.**

The program displays the Define Bookmark dialog box, which includes the list of currently defined bookmarks.

- 2 Select the name of the bookmark name you wish to delete.**
- 3 Click Delete then click OK.**

## Viewing Cross-References

Cross-references, which display as underlined text, allow you to move quickly to sections containing information related to the material in the current section. For example, from the batteries section you can go directly to the MaxTime discussion by clicking the cross reference.

To view a cross-reference, follow these steps:

- 1 Position the pointer over the cross-reference.**

The pointer changes to a pointing hand symbol.

- 2 Click the cross-reference.**

The program displays the section containing the information that relates to the cross-reference you selected.

When you have finished reading the cross-referenced material, clicking Go Back returns you to the original topic.

## Searching for a Topic

The QuickStart book has a full-text search feature, which can locate every topic that contains a word or phrase you are looking for. To use the full-text search feature, follow these steps:

**1 Choose Search and type the word or phrase in the Search Word field.**

To find all the forms of a word, you can substitute an asterisk (\*) for the last characters in the word. For example, typing bat\*, would find “batch,” “battery,” “batteries,” “battery-powered” and “battery-save.”

**2 Click OK to start the search.**

The program displays the list of topics that contain the text.

**3 Select the topic to view and click Go To.**

The program displays the topic with the word or phrase highlighted.

To exit the Search Results dialog box, click Cancel.

To start a new search, click To Search.

## Reinstalling On-line Documentation

To restore a deleted or damaged electronic book, use the master program diskette that contains the electronic book files. For more information about master program diskettes, see “Create Master Diskettes or Purchase the CD-ROM” on page 37.

Follow these steps to reinstall the *Windows QuickStart 3.11 Edition*:

**1 Be sure your diskette drive is connected to the diskette drive port. For more information about connecting the diskette drive, see “Connecting the External Diskette Drive” on page 24.**

- 2 Choose Run from the File menu and type the command line a:\install.**

Windows for Workgroups displays the Run dialog box.

- 3 In the Run dialog box, click OK to accept the default directory and follow the instructions on the screen to define the location of the files.**

If the directory does not exist, the installation program creates it for you.