



StreetPilot[®] c330

owner's manual



© Copyright 2005 Garmin Ltd. or its subsidiaries

Garmin International, Inc.
1200 East 151st Street,
Olathe, Kansas 66062, U.S.A.
Tel. 913/397.8200 or 800/800.1020
Fax 913/397.8282

Garmin (Europe) Ltd.
Unit 5, The Quadrangle,
Abbey Park Industrial Estate,
Romsey, SO51 9DL, U.K.
Tel. 44/0870.8501241
Fax 44/0870.8501251

Garmin Corporation
No. 68, Jangshu 2nd Road,
Shijr, Taipei County, Taiwan
Tel. 886/2.2642.9199
Fax 886/2.2642.9099

All rights reserved. Except as expressly provided herein, no part of this manual may be reproduced, copied, transmitted, disseminated, downloaded or stored in any storage medium, for any purpose without the express prior written consent of Garmin. Garmin hereby grants permission to download a single copy of this manual onto a hard drive or other electronic storage medium to be viewed and to print one copy of this manual or of any revision hereto, provided that such electronic or printed copy of this manual must contain the complete text of this copyright notice and provided further that any unauthorized commercial distribution of this manual or any revision hereto is strictly prohibited.

Information in this document is subject to change without notice. Garmin reserves the right to change or improve its products and to make changes in the content without obligation to notify any person or organization of such changes or improvements. Visit the Garmin Web site (www.garmin.com) for current updates and supplemental information concerning the use and operation of this and other Garmin products.



Garmin[®], StreetPilot[®], and MapSource[®] are registered trademarks of Garmin Ltd. or its subsidiaries and may not be used without the express permission of Garmin.

PREFACE

Congratulations on purchasing the Garmin® StreetPilot® c330. To get the most out of your new navigation system, take the time to go through this owner's manual and learn how to use your unit.

Serial Number

Record the serial number (8-digit number on the back of the unit) in case your c330 needs service or you want to buy more maps.

Serial Number: _____

Contact Garmin

Contact Garmin if you have any questions or if you should encounter any difficulty while using your StreetPilot c330.

In the U.S.A, contact Garmin Product Support by phone at 913/397.8200 or 800/800.1020, Monday–Friday, 8 AM–5 PM Central Time; or by e-mail at sales@garmin.com.

In Europe, contact Garmin (Europe) Ltd. at 44/0870.8501241.

Quick Links

- To find an address, see [page 4](#).
- To understand information on the Map page, see [page 11](#).
- To adjust the backlight brightness, see [page 15](#).
- To clean and protect your unit, see [pages 25–26](#).
- To use the practice mode, see [page 18](#).
- To understand safe mode, see [page 18](#).

Preface	i	Setting a Home Location.....	9	Appendix	23
Serial Number.....	i	Going Home.....	9	Mounting the c330 on Your	
Contact Garmin	i	Changing Your Home Location ...	9	Dashboard.....	23
Find It and Go!	1	Finding Recently Found Places	10	Caring for Your c330	25
Finding Your Destination	1	Deleting Recently Found Places	10	Using an SD Card	27
Following Your Route.....	2	Viewing the Map		Using the USB Drivers	
Where To?  Where to?	3	and Other Pages	11	and Cable.....	27
Finding a Place by Spelling		Viewing the Map Page	11	Updating the c330 Software	
the Name	3	Trip Information Page.....	12	and Map Data	28
The Where To? Menu.....	3	Current Route Page.....	13	Resetting Your c330	28
Finding an Address	4	Next Turn Page		Technical Specifications	29
Finding a Place Using the Map	5	and Voice Directions.....	13	Battery Information	29
Browse Map Tips	5	Adding a Detour to a Route..	14	Changing the Fuse.....	29
Expanding Your Search.....	6	Stopping Your Route	14	Charging the c330	29
My Locations 	7	Customizing the c330	15	Software License Agreement	30
Saving Places You Find	7	Adjusting the Brightness.....	15	Index	31
Finding Saved Places.....	7	Changing the c330's Settings	16		
Understanding My Locations...	7	Changing Map Settings.....	17		
Editing Saved Places	8	Changing System Settings	18		
Changing the Name	8	Changing Time	19		
Changing the Map Symbol	8	Changing the Color Mode	20		
Deleting Saved Places	8	Changing Navigation	21		
		Changing Language	22		

FIND IT AND GO!

Use the Garmin StreetPilot c330 to find your destination and go to it!

Finding Your Destination

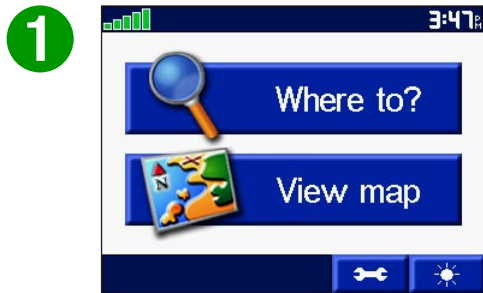

Touch **Where to?**



Select a category.



Select a destination.



Touch **Go!**

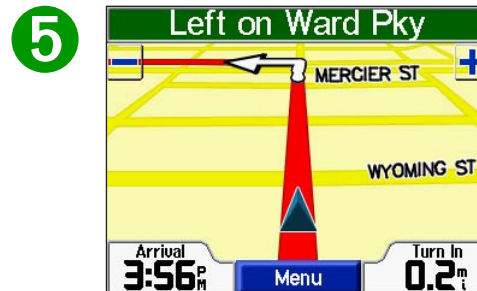

Enjoy the route!

Following Your Route

Follow the route to your destination using the Map page. As you travel, your c330 guides you to your destination with vocal prompts, turn arrows on the map, and directions at the top of the Map page. If you depart from the original route, your c330 voice announces that you are off-route and then provides new route instructions.

Read the driving instructions at the top of the page.

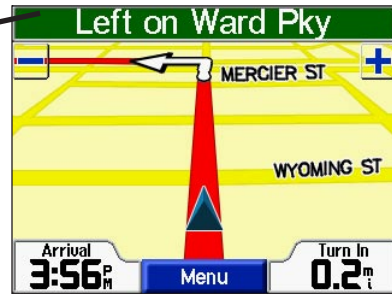

Your route is marked with a red line.

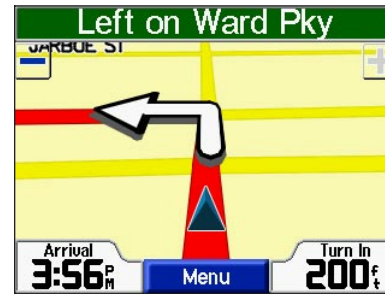

Follow the arrows as you take turns.



A checkered flag marks your destination.

For more information about using the Map page, see pages [11–14](#).

WHERE TO?



Finding a Place by Spelling the Name



To enter the name of the place you are looking for, open the Menu page. Touch **Where to?** > **Spell Name**.

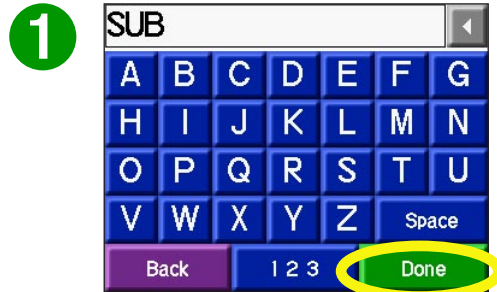

Enter a place using the on-screen keyboard. Then touch **Done**.

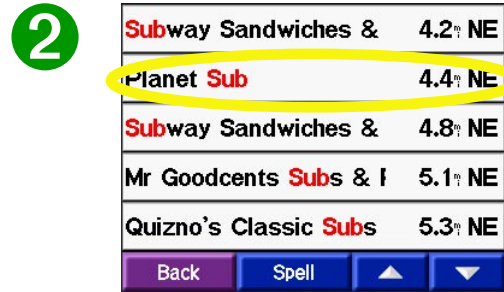

Select the place you want to visit.

You can also spell the item's name to narrow your search results list. Touch the **Spell** button at the bottom of the list. Enter the item's name to narrow the results list.

The Where To? Menu

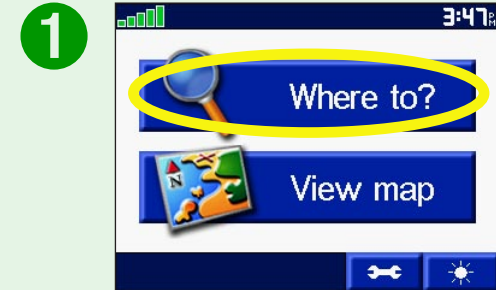

Touch **Where to?**



Select a category. Touch the arrows to see more categories.

Finding an Address



To find an address, touch **Where to?** from the Menu page. Touch **Address**.



Select a state.

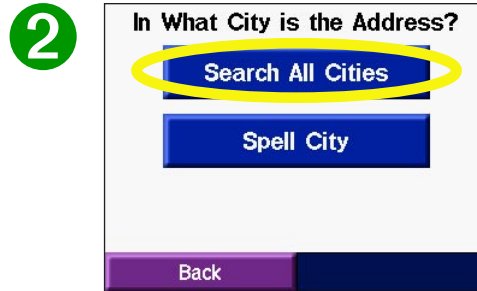

Touch **Search All Cities**.



Type the number of the address and touch **Done**.



Type the street name until a list of streets appears or touch **Done**. Select the street.



If necessary, touch the address. Touch **Go!**.



Finding an intersection is very similar to finding an address; touch **Intersection** and enter the two street names.

Finding a Place Using the Map



Use the Browse Map page to view different parts of the map. Touch **Where to? > Browse Map**.



1 Touch any object on the map and select **Info**.

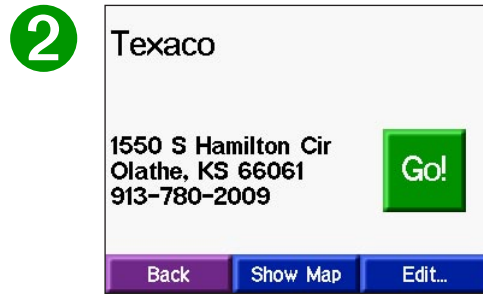

2 Touch **Go!**.

Viewing Places on the Map

You can view a place you have found on the Browse Map page.

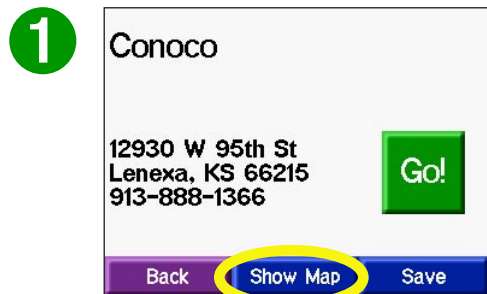

1 Touch **Show Map**.

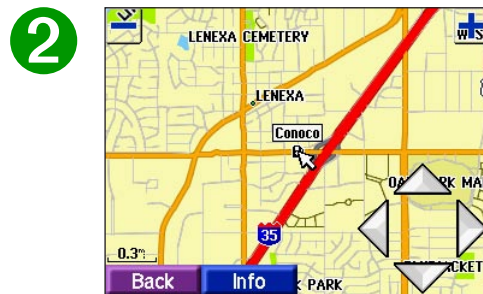

2 Touch **Back** when you are done.

Browse Map Tips

- Touch the arrows to move the map around.
- Use the and icons to zoom in and out.
- Touch the item you are looking for. An arrow appears pointing at the object you selected.
- Touch **Back** to return to the previous screen.

Expanding Your Search



From the Main Menu, touch **Where To?** Then touch the **Near** button.



Select one of the search options. Touch **OK**.

Where I Am Now—searches for places near your current location. Your unit automatically uses this option.

A Different City—searches for places near the city you enter. For example, enter “Denver” to search for places near Denver.

My Current Route—searches for places along the route you are currently navigating.

My Destination—searches for places near the end of the route you are currently navigating.

Tip

Your c330 automatically searches for places near your current location.

My LOCATIONS

Saving Places You Find



After you have found a place, touch **Save**.



Touch **OK** to close the pop-up window.

Finding Saved Places

From the Menu page, touch **Where to? > My Locations**.

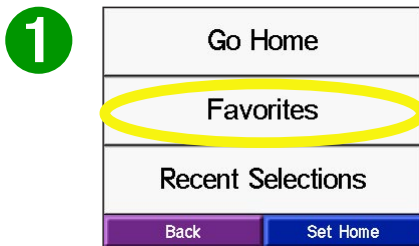

Touch **Favorites**.



Select the place you want to visit.

Understanding My Locations

Think of My Locations as a container that stores all of your favorite places. You can set your Home location in My Locations. You can also find places that you have recently found.

Editing Saved Places

After you save a place, you can change the name of the place and its symbol on the map. From the Menu page, touch **Where to?** > **My Locations**.

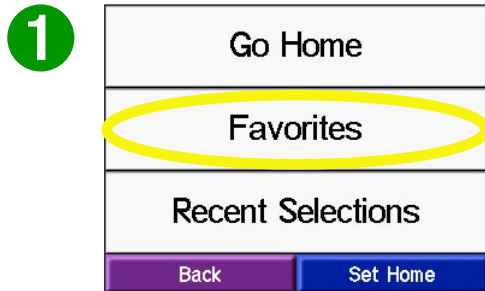

Touch **Favorites**.



Select the place you want to edit.



Touch the **Edit** button. The Edit window opens.

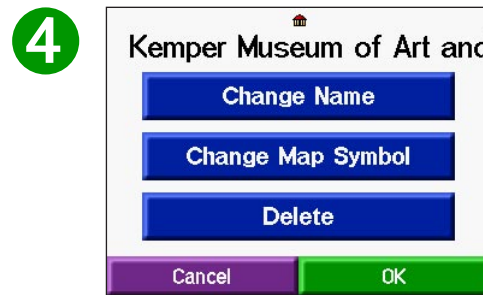

Touch a button to change the name or the map symbol, or to delete the item.

Changing the Name

To change the name of the saved place, touch **Change Name**. Enter the new name using the on-screen keyboard that appears. Touch **Done**.

Changing the Map Symbol

To change the symbol of this place used on the map, touch **Change Map Symbol**. Select a symbol from the list that appears.

Deleting Saved Places

To delete this saved place, touch **Delete**. Then touch **Yes**.

Setting a Home Location

You can set a Home location for the place you return to most often. After you have set your Home, you can easily **Go Home**.



Touch **Where To?** >
My Locations.

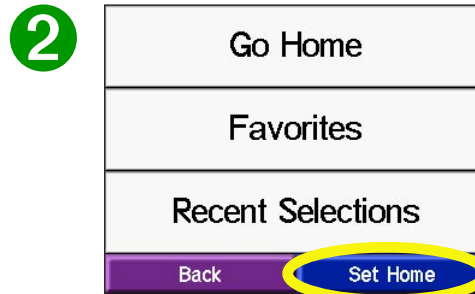

Touch **Set Home**.

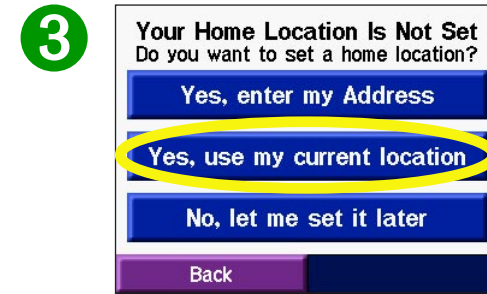

Touch **Yes, use my current location**.

Going Home

Once your Home location is set, you can route to it at any time by touching **My Locations** and then **Go Home**.

Changing Your Home Location

Change your Home location by repeating the steps you took to set it.

Finding Recently Found Places

Your c330 stores the last 50 of your recent finds in Recent Selections. The most recently viewed places appear at the top of the list. From the Main Menu, touch **Where to? > My Locations** to view your recently found items.



Touch **My Locations > Recent Selections**.



Select an item from the list.

Deleting Recently Found Places

To remove all places from the Recent Selections list, touch **Clear**. Then touch **Yes**.

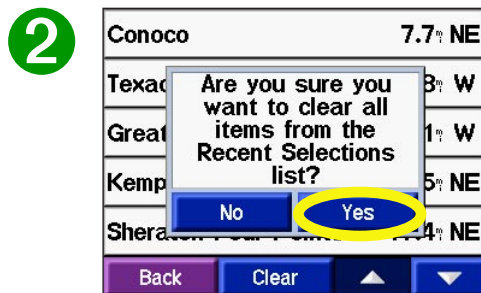
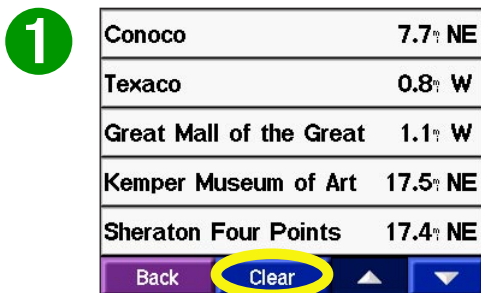

NOTE: When you touch **Clear**, all items from the list are removed. It does not delete the actual place from your unit's system.

VIEWING THE MAP AND OTHER PAGES

Viewing the Map Page



From the Menu page, touch **View map** to open the Map page. The position icon ▲ shows your current location. Touch buttons on the Map page to see additional information.

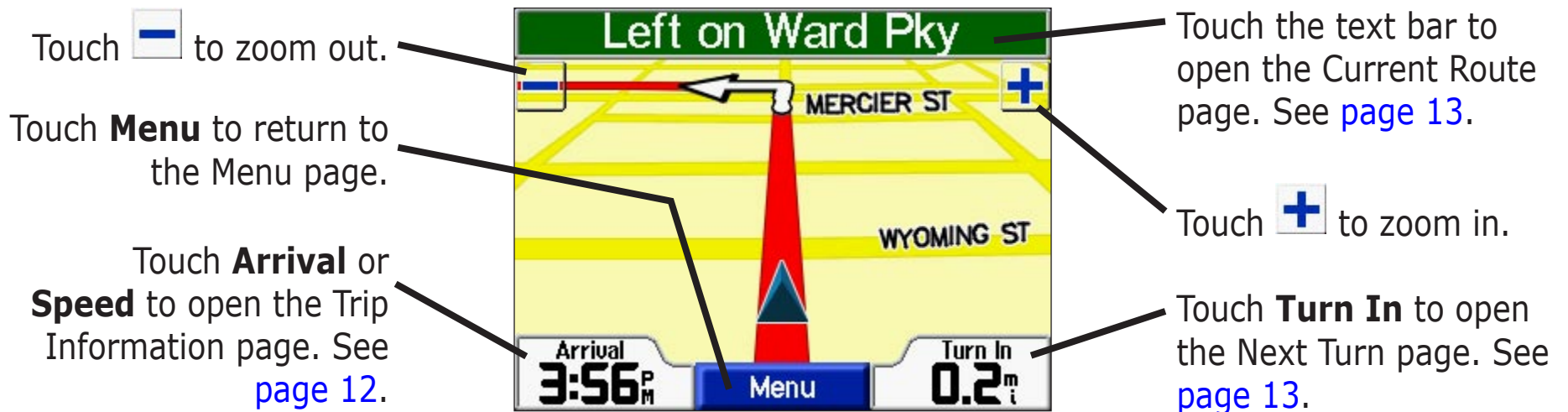

Map Page while Navigating a Route

Trip Information Page

The Trip Information page indicates your current speed and provides helpful statistics about your trip. To view the Trip Information page, select **Speed** or **Arrival** on the Map page.

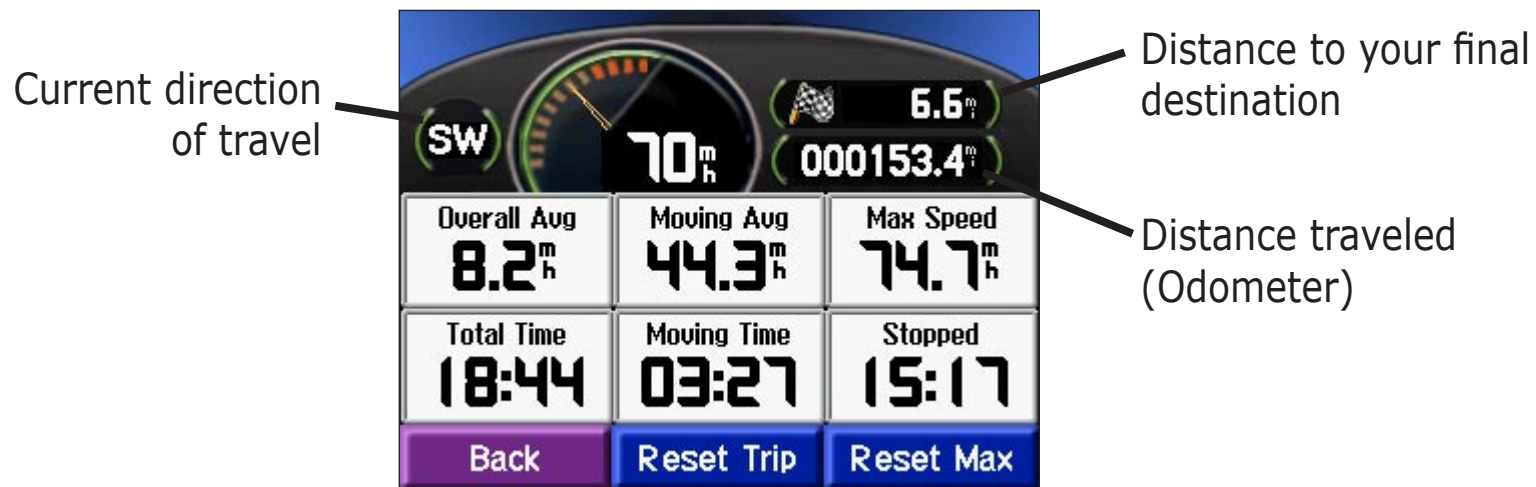

Trip Information Page

Resetting Trip Information

If you want accurate trip information, reset the trip information before beginning a trip. If you make frequent stops, leave the c330 turned on so it can accurately measure elapsed time during the trip.

Select **Reset Trip** to reset the information on the Trip Information page. Select **Reset Max** to reset the Maximum Speed.

Current Route Page

The Current Route page displays turn-by-turn instructions for your entire route. Touch the green text bar on the top of the Map page to open the Current Route page. This page displays all turns in the route and the distance between turns. Select a turn on the list to view the Next Turn page for that turn.

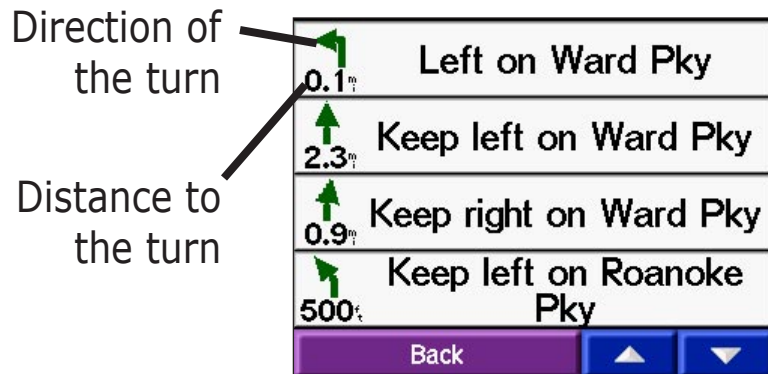

Current Route Page

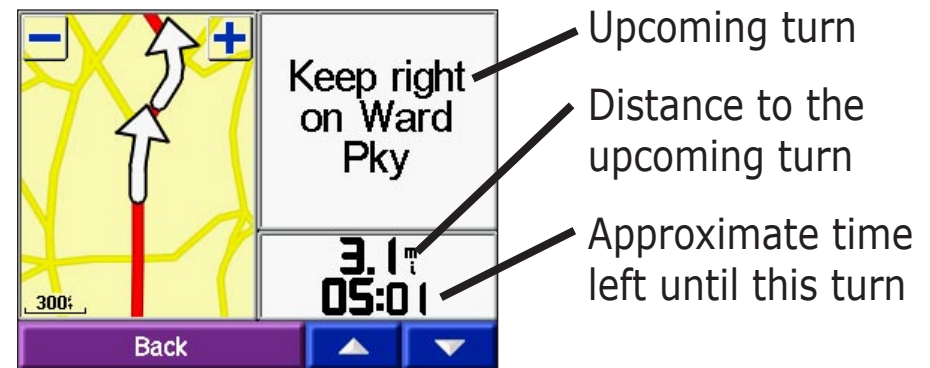

Next Turn Page

Next Turn Page and Voice Directions

The Next Turn page shows the turn on the map and the distance and time left before you reach the turn. To view an upcoming turn on the map, select **Turn In** on the Map page, or select any turn from the Current Route page.

Use the up and down arrows to view other turns in the route. When you are finished viewing the Next Turn page, select **Back**.

Adding a Detour to a Route

If you need to take a detour from your current route, select **Detour** from the Menu page of the c330. The unit calculates a new route and provides you with new instructions. The c330 attempts to get you back on your original route as soon as possible.

On some routes, the route you are currently taking might be the only reasonable option. In this case, you cannot take a detour.

Stopping Your Route

If you want to stop your current route, return to the Menu page and select **Stop**.

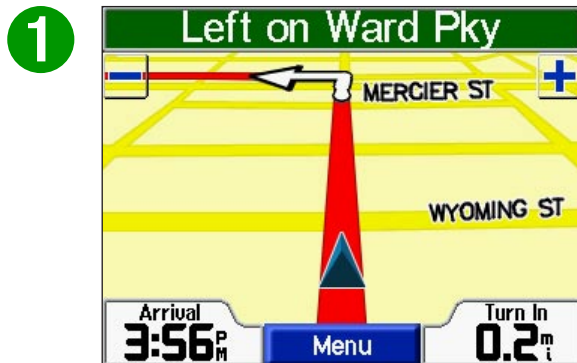

Select **Menu** to return to the Menu page.

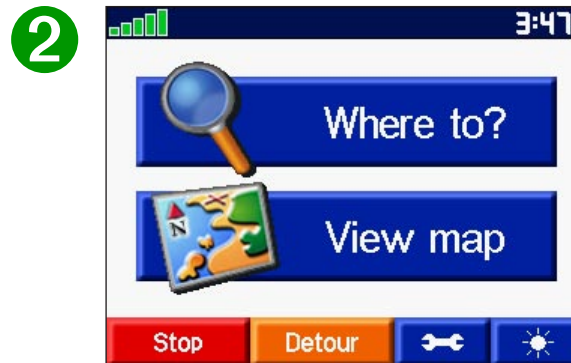

Select **Stop** to end navigation. Select **Detour** and your unit creates a new route if possible.

CUSTOMIZING THE c330

Adjusting the Brightness

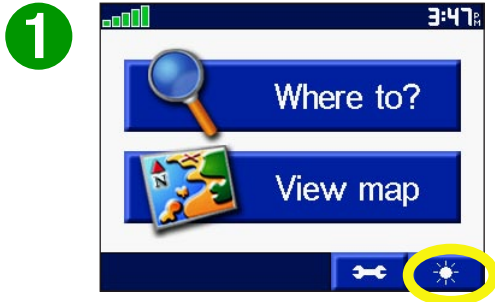

Touch the  button



Touch the minus and plus signs to adjust the backlight. Touch **OK**.

Changing the c330's Settings

To change c330 settings, touch  from the Menu page. See the following pages for more information.

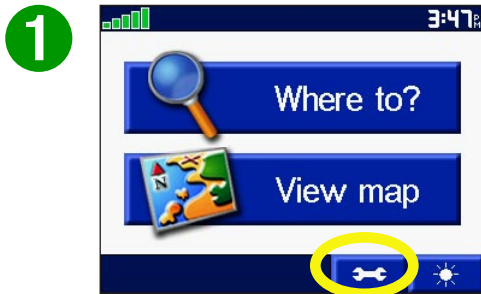

Select the  button to display the Settings page.



Select the setting you want to change.

Restoring Settings

To restore all settings you have changed, press the **Restore Settings** button, as shown below.



To restore settings for an individual category, such as Map, touch the Restore Settings button on that particular page.

Changing Map Settings

Map Detail—adjust the amount of detail shown on the map. Displaying more detail causes the map to redraw slowly.

Map View—change the perspective of the Map page.

- **Track Up**—display the map in 2 dimensions (2-D) with your direction of travel at the top.
- **North Up**—display the map in 2-D with North at the top.
- **3 Dimensional**—display the map in 3 dimensions (3-D), Track Up orientation. This is the default map view.

Map Info—list the maps loaded on your c330. Refer to this when you are ready to update your map software.

Restore—restore the original map settings.

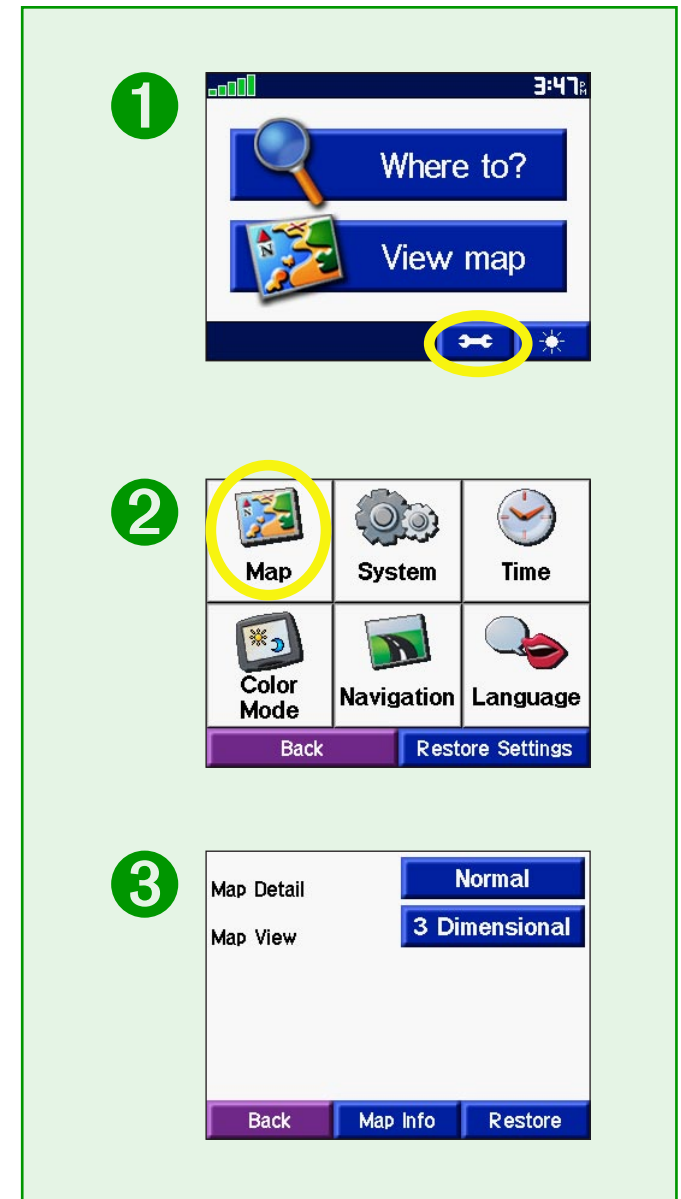

Changing System Settings

GPS Mode—set the unit’s GPS receiver. Select **WAAS** to enable the WAAS system. Select **GPS Off** if you want to simulate routes indoors (“practice mode”) with your c330.

Units—change units of measure to kilometers (Metric) or miles (Statute).

Safe Mode—enable or disable the Safe Mode feature to improve driver safety. When your vehicle is moving, Safe Mode disables all unit functions that require significant operator attention and could become a distraction while driving.

About—display your c330’s software version number, unit ID number, and audio version number.

Restore—restore the original system settings.

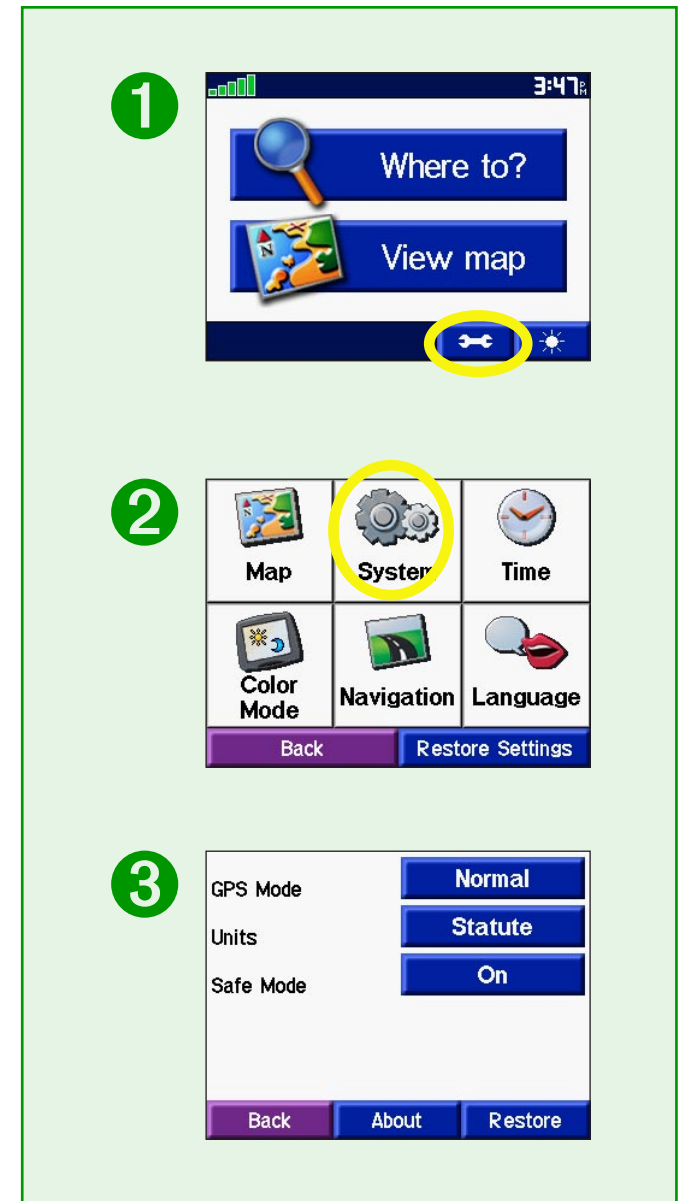

Changing Time

Time Format—choose a 12- or 24-hour time format or UTC time.

Time Zone—set the c330 to one of the U.S. time zones or choose from a list of cities all over the world.

Daylight Savings—set to On, Off, or Auto if it is available.

Restore Settings—restore the original time settings.

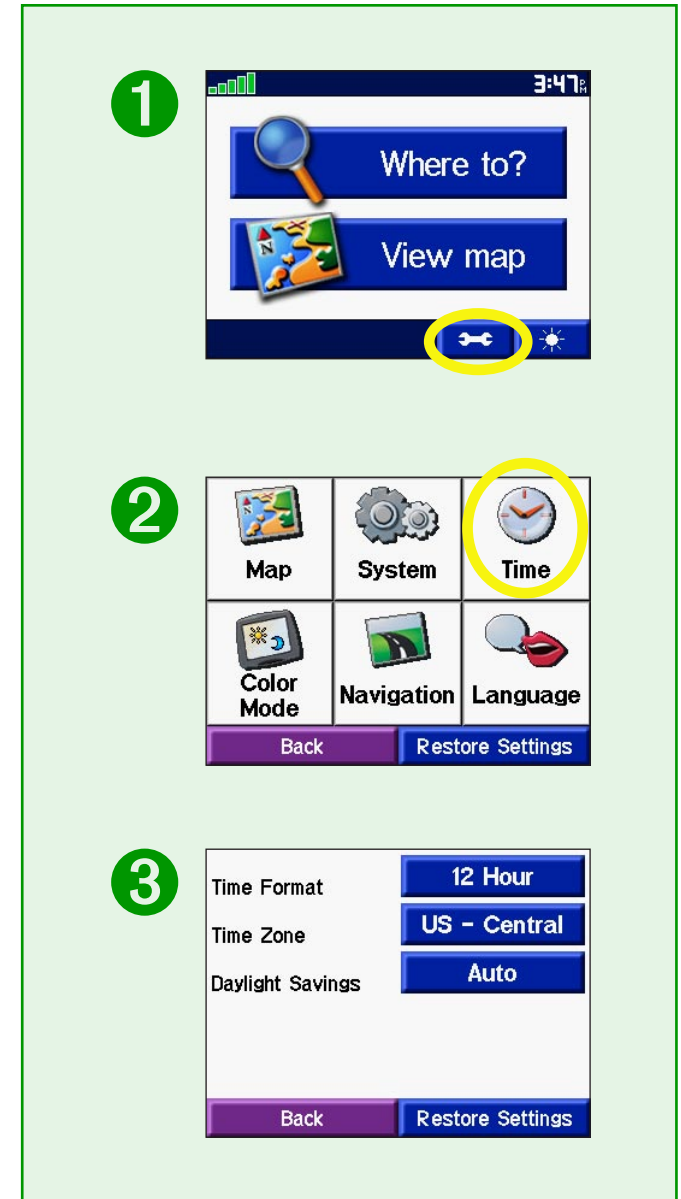

Changing the Color Mode

Color Mode—select one of the following options:

Daytime—light background.

Nighttime—black background.

Auto—automatically switch between the two at sunrise and sunset.

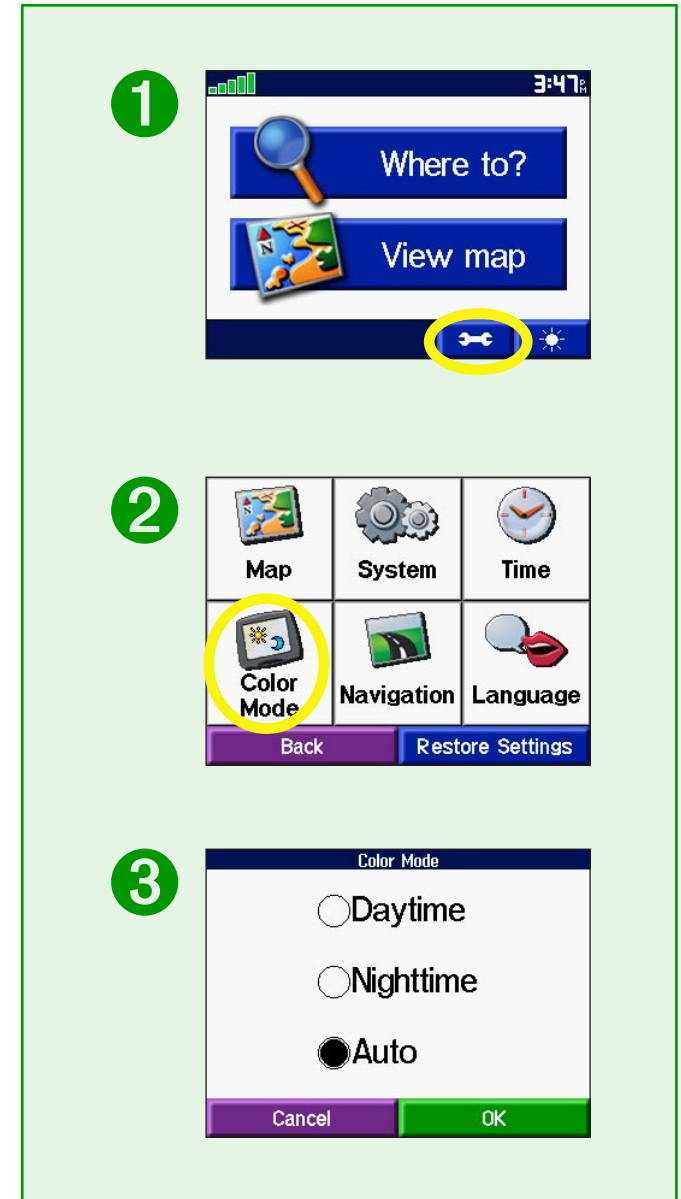

Changing Navigation

Route Preference—select a preference for calculating your route. Select **Faster Time** to calculate routes that are faster to drive but can be longer in distance. Select **Shorter Distance** to calculate routes that are shorter in distance but can take more time to drive.

Vehicle—specify your vehicle type to optimize routes.

Avoidances—select the **Enabled** button to access the road types. Select the road types you want to avoid on your routes. The c330 uses these road types only if alternative routes take you too far out of your way or if no other roads are available.



Attention Tone—turn the chime before voice prompts on and off.

Restore Settings—restore the original navigation settings.

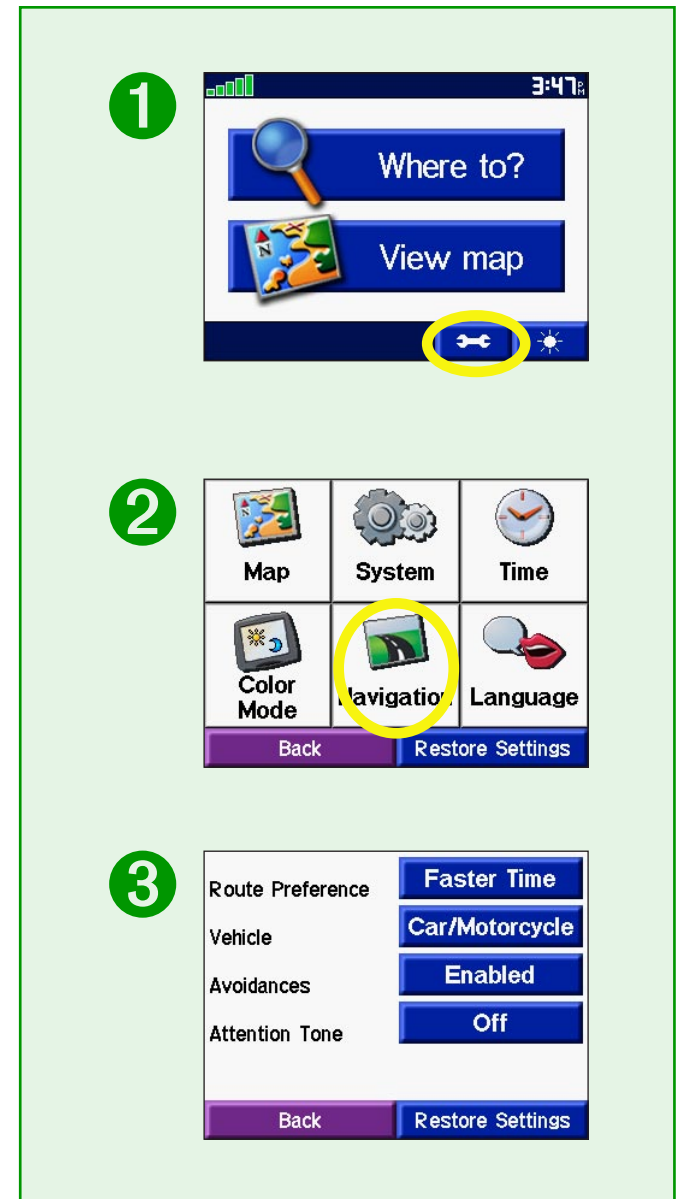

Changing Language

Text Language—change all on-screen text to the selected language. Changing the Text Language does not change the language of map data, such as street names and places or user-entered data.

Voice Language—change the language for all voice prompts and messages to the selected language.

Restore Settings—restore the original language settings.

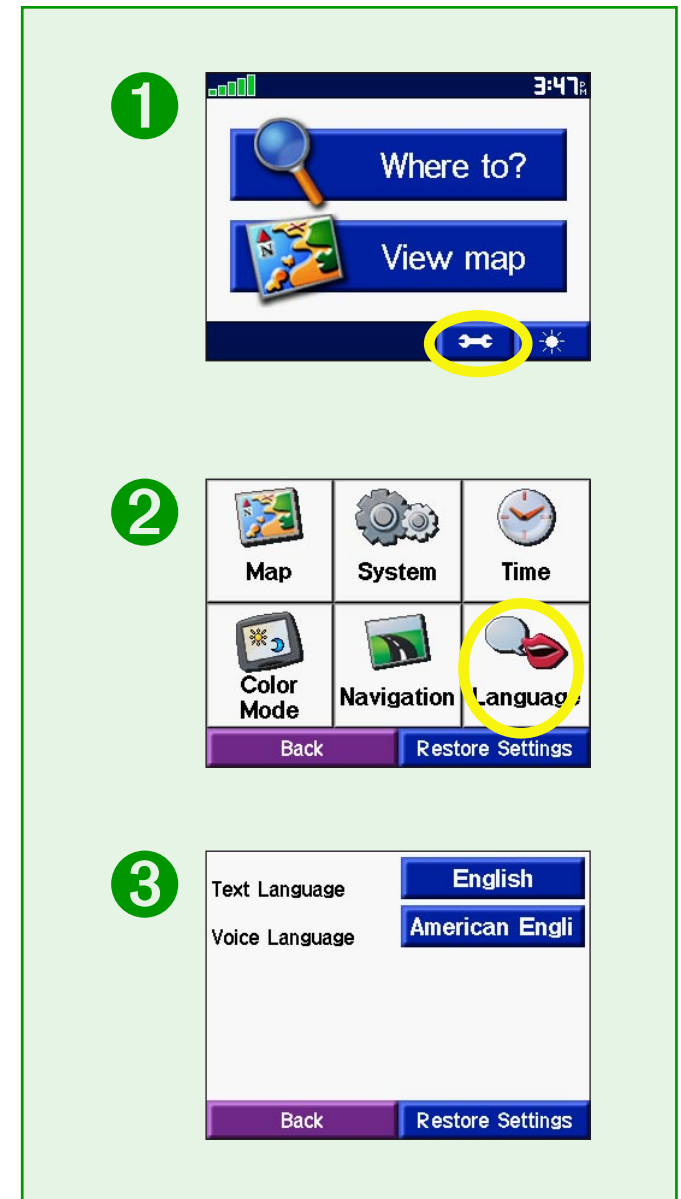

APPENDIX

Mounting the c330 on Your Dashboard

Use the enclosed mounting disk to mount your unit to the dashboard. California drivers, use the enclosed disk to comply with California regulations: see the *c-series Product Information Sheet* that came in the box for more information.

Important: The **permanent** mounting adhesive is extremely difficult to remove after it is installed.

To install the mounting disk:

1. Clean and dry the dashboard where you will place the disk.
2. Remove the backing from the permanent mounting adhesive on the bottom of the disk and place the disk on the dashboard.
3. Place the c330 (still mounted to the suction cup mount) on top of the disk. Flip the suction lever to secure the suction cup mount to the disk.

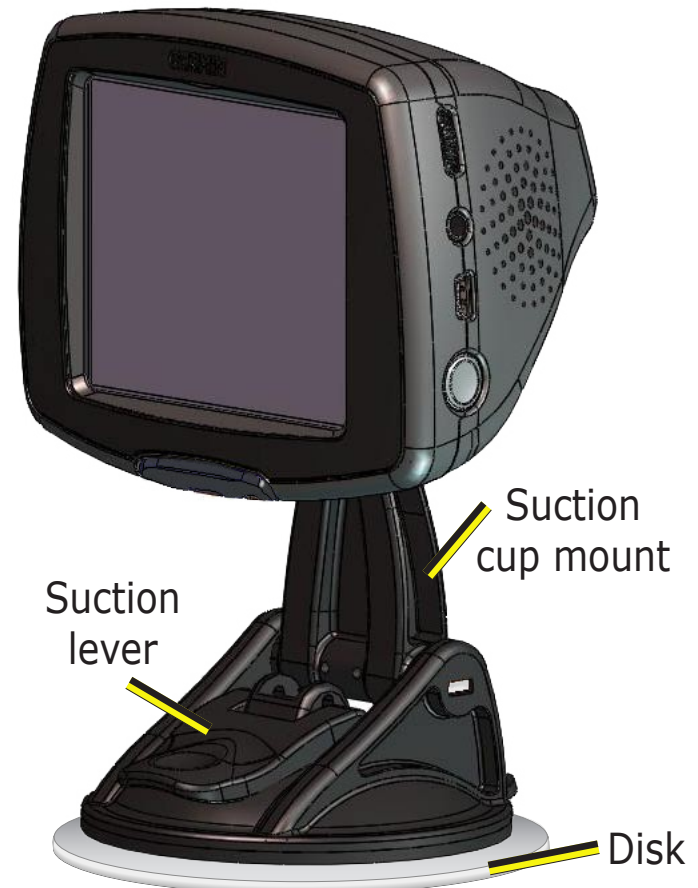

Removing the Unit and the Mount

To remove the unit from the mount, press the indentation on the back of the unit. Then, lift the unit off of the mount.

To remove the suction cup from the windshield, flip the lever toward you and pull the tab on the suction cup toward you.

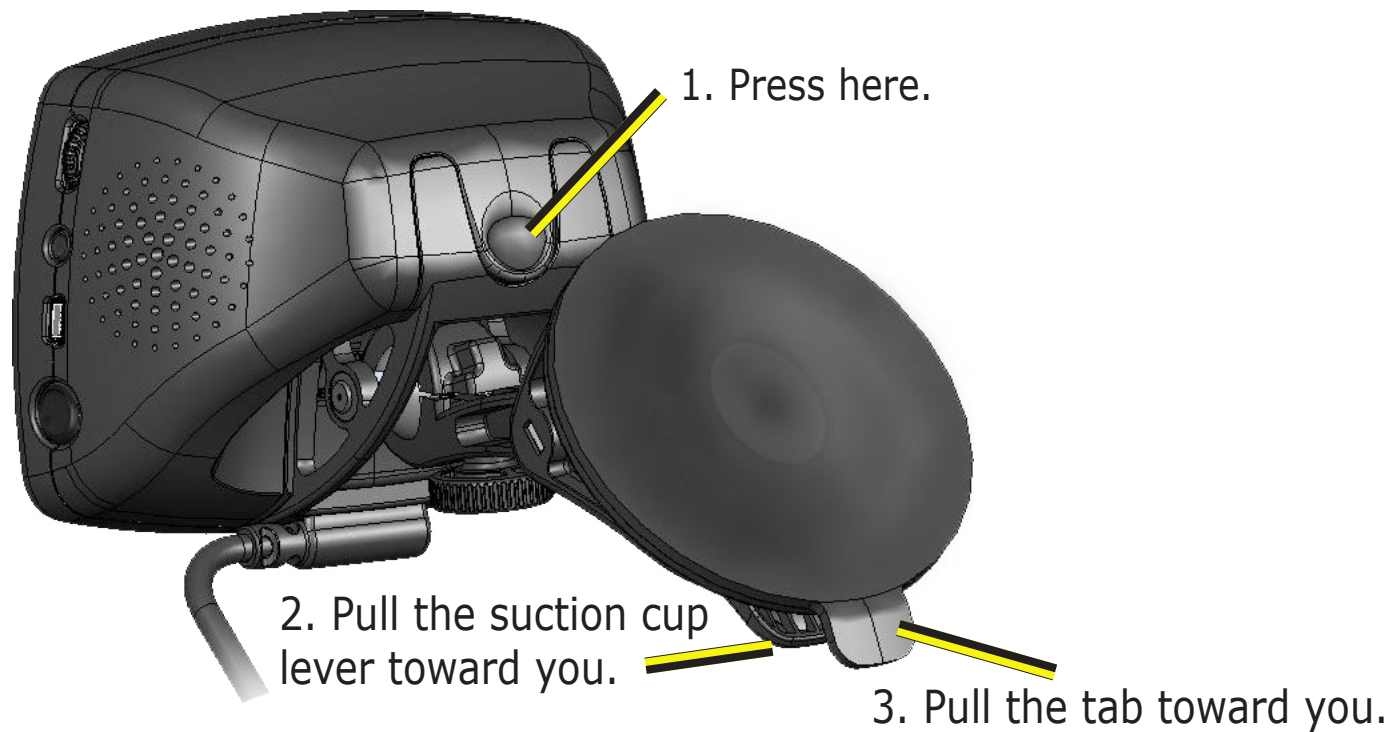

Caring for Your c330

Your c330 contains sensitive electronic components that can be permanently damaged if exposed to excessive shock or vibration. To minimize the risk of damage to your c330, avoid dropping your unit and operating it in high shock/vibration environments.

Cleaning the Unit

The c330 is constructed of high quality materials and does not require user maintenance other than cleaning. Clean the unit's outer casing (except for the touch screen) using a cloth dampened with a mild detergent solution and then wipe dry. Avoid chemical cleaners and solvents that can damage plastic components.

Cleaning the Touch Screen

The touch screen is intended primarily to be operated with a finger. Though a PDA stylus can also be used to operate the touch screen, never attempt this while operating a vehicle. Never use a hard or sharp object to operate the touch screen or damage may result. The touch screen should be cleaned using a soft, clean, lint-free cloth. Water, isopropyl alcohol, or eyeglass cleaner can be used if needed. If these are used, apply the liquid to the cloth and then gently wipe the touch screen.

Calibrating the Touch Screen

If you think the touch screen is not responding properly, press and hold the **Power** button until the Calibration screen appears. Follow the on-screen instructions.

Protecting Your c330

Follow the cautions below to protect your c330 from damage:

- Do not store the c330 where prolonged exposure to extreme temperatures can occur (such as in the trunk of a car), as permanent damage may result.
- Do not expose the c330 to water. Contact with water can cause this unit to malfunction.
- Do not leave your c330 in plain sight when you leave your vehicle. Take your unit with you or remove it from view to avoid theft.

Using the c330 Responsibly

Your unit is equipped with a “Safe Mode” feature to improve driver safety. Safe Mode disables certain functions that can distract you while driving. See [page 18](#) for more information.

Using the c330 Indoors

You can set your c330 to indoor use, which stops satellite reception. Use this setting when you are practicing using the unit. To turn off satellite reception, set the unit to **GPS Off**. See [page 18](#).

Using a Remote Antenna

You can use an optional external remote antenna (Garmin GA 27C). This is very helpful when operating the unit in a vehicle with a coated windshield or an in-screen (in the window) heating system, which can block GPS signals. Connect the antenna to the connector located on the back of the c330. To purchase, go to the Garmin Web site at <http://www.garmin.com/products/sp330> and select the **Accessories** link.

Using an SD Card

You can use an SD memory card for additional maps.

Inserting an SD Card

The SD card slot is located on the side of the c330. To insert or remove the card, press it in until it clicks.



Purchasing Additional MapSource Maps

You can purchase additional MapSource map data from Garmin and download the maps to your SD card. The original maps that came installed on your c330 are protected from overwriting; you cannot accidentally delete them.

Follow the instructions that came with the new map data to properly install the maps to your computer and c330.

In order to enable additional maps, you need your unit ID (see [page 18](#)) and serial number (see [page i](#)).

Using the USB Drivers and Cable

Use the enclosed CD-ROM to install the USB drivers onto your computer. These drivers must be installed before you connect the USB cable to your computer.

Use the Garmin USB cable provided to connect your c330 to your computer. This is necessary when updating your map data, updating the c330 software, or loading additional maps.

Plug the small end of the USB cable into the connector above the power button. Plug the other end of the cable into an available USB connector on your computer.

Updating the c330 Software and Map Data

Garmin periodically updates its software and map data. If you register your unit, you will receive notification of software and map updates.

Check the Garmin Web site at <http://www.garmin.com/unlock/update.jsp> to see if an update for your map software is available. Also check <http://www.garmin.com/products/sp330/> and select the **Software Updates** link to see if an update to the c330's internal software is available.

See [page 17](#) for instructions on how to find your current MapSource software and version number.

Resetting Your c330

If your unit locks up, press the **Power** button to turn off the unit, then press again to turn the unit back on. If this does not help, reset your c330.

To reset the c330:

1. Place your thumb nail in the groove located under the Garmin logo on the face plate.
2. Gently pull off the face plate.
3. Press the **Reset** button.
4. Turn the unit back on; it will operate normally.

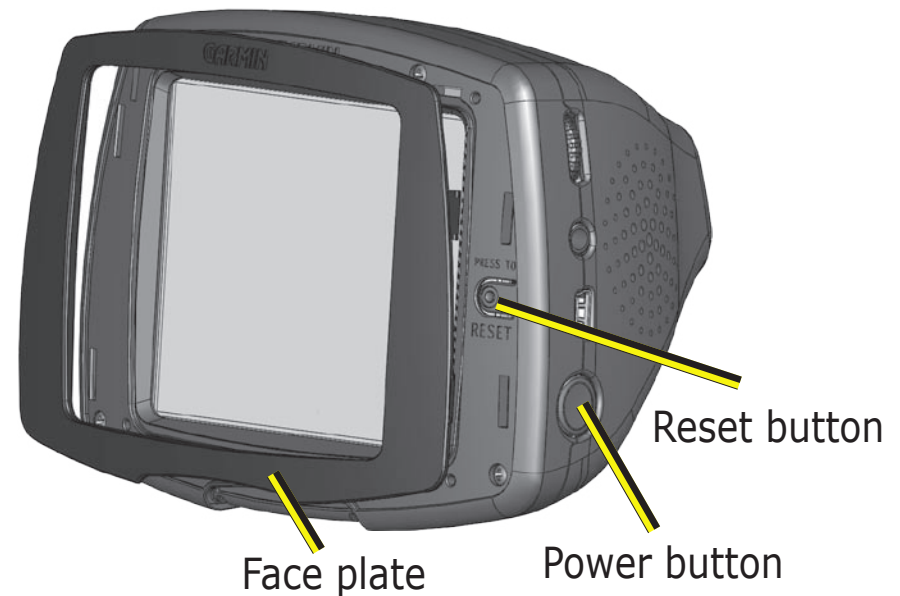

Technical Specifications

Size: 4.4" W x 3.2" H x 2.8" D

Weight: 9.45 ounces

Display: QVGA transfective TFT; 64K colors; bright white LED backlight, and touch screen

Map Storage: Internal non-removable memory and an optional removable SD memory card

Temperature: 32°F to 122°F (0°C to 50°C)

Power Supply: AGC/3AG 2 Amp fuse

Charge Time: Approximately three hours to charge

For a complete list of specifications, visit the Garmin Web site at <http://www.garmin.com/products/sp330/spec.html>.

Battery Information

Your unit contains an internal lithium-ion battery. To maximize battery life, limit your c330's prolonged exposure to excessive heat and direct sunlight. Contact your local waste disposal department for information on properly disposing of the unit.

Changing the Fuse

An AGC/3AG 2 Amp, high-breaking capacity, 1500 A-rated fuse is located at the tip of the vehicle adapter. Periodically, you may need to change the fuse. Unscrew the black, round end piece and replace the fuse.

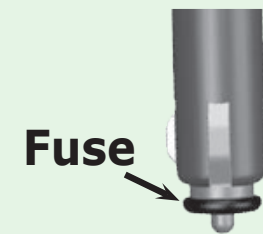

Charging the c330

You can charge the c330 using USB cable (see [page 27](#)) or the car adapter that is connected to the suction mount.

Software License Agreement

BY USING THE c330, YOU AGREE TO BE BOUND BY THE TERMS AND CONDITIONS OF THE FOLLOWING SOFTWARE LICENSE AGREEMENT. PLEASE READ THIS AGREEMENT CAREFULLY.

Garmin grants you a limited license to use the software embedded in this device (the “Software”) in binary executable form in the normal operation of the product. Title, ownership rights, and intellectual property rights in and to the Software remain in Garmin.

You acknowledge that the Software is the property of Garmin and is protected under the United States of America copyright laws and international copyright treaties. You further acknowledge that the structure, organization, and code of the Software are valuable trade secrets of Garmin and that the Software in source code form remains a valuable trade secret of Garmin. You agree not to decompile, disassemble, modify, reverse assemble, reverse engineer, or reduce to human readable form the Software or any part thereof or create any derivative works based on the Software. You agree not to export or re-export the Software to any country in violation of the export control laws of the United States of America.

 **NOTE:** *The Garmin c330 has no user-serviceable parts. Should you ever encounter a problem with your unit, take it to an authorized Garmin dealer for repairs.*

 **NOTE:** *The c330 is fastened shut with screws. Any attempt to open the case to change or modify the unit in any way voids your warranty and may result in permanent damage to the equipment.*

INDEX

Symbols

- 2 Dimensional 17
- 3 Dimensional 17

A

- About button 18
- Audio version 18
- Avoiding water damage 26
- Avoid road types/items 21

B

- Backlight brightness 15
- Battery information 29
- Browse Map Page 5

C

- Calibrating the touch screen 25
- Caring for your c330 25
- Cleaning 25
- Color mode 20
- Contact Garmin i
- Current location 11
- Current Route Page 13

- Customizing the c330 15
 - color mode 20
 - language 22
 - map 17
 - navigation 21
 - system setup 18
 - time 19

D

- Daylight Savings 19
- Deleting saved places 8
- Detour, adding 14
- Driving directions 13

E

- Editing saved places (My Locations) 8
- Expanding your search 6

F

- Favorites 7, 8
- Finding places
 - address 4
 - by name 3
 - intersection 4
 - item on the map 5
 - near another place 6
 - recent selection 10
 - saved item 7

- Following your route 2
- Fuse 29

G

- Go Home 9
- GPS
 - issues maintaining a fix 26
 - mode 18
 - turn off 26

H

- Home Location 9
 - change home 9
 - go home 9
 - set home 9

I

- Info button 5
- Items to avoid 21

K

- Keyboard 3

L

- Language 22
- License Agreement 30

M

- Map 5, 11
 - browse 5
 - customize 17
 - zoom 11
- MapSource 27, 28
- Map Info button 17
- Map software
 - update 28
 - version 17
- Map symbol 8
- Map view 17
- Metric units 18
- Mounting the c330 23
- My Locations 7
 - Favorites 7, 8
 - Go Home 9
 - Recent Selections 10

N

- Narrow your results list 3
- Navigation settings and preferences 21
- Near button 6
- Next Turn Page 13
- North Up 17

O

On-screen keyboard 3

P

Position icon 11

Practice mode 18

R

Recently Found places

delete 10

find 10

Resetting your c330 28

Reset Max Speed 12

Reset Trip 12

Road types to avoid 21

Route

detour 14

following 2

preferences 21

stop 14

S

Safe Mode 18, 26

Saved Places

change the map symbol 8

change the name 8

delete 8

edit 8

Saving Places you Find 7

SD Card 27, 29

Serial Number i

Software License Agreement 30

Software version 18

Spelling the name 3

Stopping Route Navigation 14

Storing the c330 26

System Setup, customizing 18

T

Theft, avoiding 26

Time 19

customize 19

Touch screen

calibrate 25

clean 25

Track Up 17

Trip Information Page 12

Turn-by-turn directions 13

U

Units 18

Unit ID 18

USB 27

Using responsibly 26

V

Vehicle type 21

Viewing places on the map 5

Viewing the map 11

Voice directions 13

Z

Zoom 5, 11

For the latest free software updates (excluding map data) throughout the life of your Garmin products, visit the Garmin Web site at www.garmin.com.



© Copyright 2005 Garmin Ltd. or its subsidiaries

Garmin International, Inc.

1200 East 151st Street, Olathe, Kansas 66062, U.S.A.

Garmin (Europe) Ltd.

Unit 5, The Quadrangle, Abbey Park Industrial Estate, Romsey, SO51 9DL, U.K.

Garmin Corporation

No. 68, Jangshu 2nd Road, Shijr, Taipei County, Taiwan

www.garmin.com

Part Number 190-00436-00 Rev. D