

# DataHand Personal User's Guide

Version 1.7.8  
October 9, 2003



DataHand® Systems

---

© Copyright 1997, DataHand® Systems, Inc.  
3032 North 33<sup>rd</sup> Avenue  
Phoenix, AZ 85017

All rights are reserved. No part of this publication may be reproduced, stored in a retrieval system or transmitted in any form or by any means, mechanical, photocopying, recording or otherwise, without the prior written permission of DataHand® Systems, Inc.

DataHand® Systems is a registered trademark of DataHand® Systems, Inc. Apple is a registered trademark of Apple Computer, Inc. IBM is a registered trademark of IBM Corporation. Microsoft and Windows are registered trademarks of Microsoft Corporation.

Neither DataHand® Systems, Inc. nor its affiliates shall be liable to the purchaser of this product or third parties for damages, losses, costs or expenses incurred by purchaser or third parties as a result of: accident, misuse or abuse of this product or unauthorized modifications, repairs or alterations to this product.

DataHand® Systems, Inc. and its affiliates shall not be liable for any damages or problems arising from the use of any options or any consumable products other than those designated as original DataHand® Systems, Inc. products or DataHand® Systems, Inc. approved products.

# ***Congratulations!***

***For choosing the world's finest  
User-to-computer interface.***

You are now on the leading edge of interface technology. Your DataHand® System is a new and advantageous way to work with your computer. Learning to use the system requires commitment, patience and persistence, which will be well rewarded by increased comfort, reduced exposure to injury and long-term productivity increases.

**Although this DataHand® System was designed with the goal of reducing injury exposure, the prolonged use of any manually operated data entry device (including this DataHand® System) may result in repetitive stress injury or related injury.**

If pain, discomfort, numbness or tingling in the hands or arms is experienced during or as a result of use, consult an appropriate medical professional and reduce usage until discomfort is eliminated. *Avoid other activities that may aggravate your condition, such as using other less ergonomic keyboards.* To reduce your risk of repetitive stress injury, please see the ergonomic guidelines in the *Ergonomic Suggestions* section of this user manual.

Take frequent breaks from typing and maintain good health habits.

# CONTENTS

## SECTION 1

<b>WHAT IS THE DATAHAND<sup>®</sup> SYSTEM?</b>	<b>1</b>
<b>Advantages Of The DataHand<sup>®</sup> System</b>	<b>3</b>
<b>Be Comfortable While Working</b>	<b>3</b>
<b>Type With Only Slight Finger Movements</b>	<b>3</b>
<b>Increase Your Efficiency</b>	<b>3</b>
<b>Hardware Compatibility</b>	<b>4</b>
<b>Software Compatibility</b>	<b>4</b>
<b>Care and Maintenance</b>	<b>4</b>

## SECTION 2

<b>GETTING STARTED</b>	<b>5</b>
<b>Checking the Parts in Your Shipment</b>	<b>6</b>
<b>Identifying the Components of the Hand Units</b>	<b>7</b>
<b>Positioning the DataHand Ergonomic Keyboard</b>	<b>8</b>
<b>Connecting the Equipment</b>	<b>8</b>

## SECTION 3

<b>POSITIONING YOURSELF</b>	<b>12</b>
<b>Ergonomic Suggestions</b>	<b>13</b>
<b>Using The LapLander<sup>™</sup></b>	<b>13</b>

SECTION 4		
	<b>TRAINING AIDS</b>	<b>16</b>
	Using the Training Aids	17
SECTION 5		
	<b>LEARNING TO USE THE HAND UNITS</b>	<b>19</b>
	Learning a New Skill	20
	Setting Reasonable Performance Expectations	20
	Moving Your Fingers to Press the Keys	21
	Moving Your Thumbs to Press the Keys	22
SECTION 6		
	<b>THREE MODES OF OPERATION</b>	<b>23</b>
	Accessing Different Modes	24
	Using Protected Mode Keys	25
	Keys Available in Several Modes	25
	Normal Mode	26
	Keys Available in Normal Mode	26
	Accessing Normal Mode	26
	Layout of Keys in Normal Mode	28
	NAS Mode	29
	Keys Available in NAS Mode	29
	Accessing NAS Mode	29
	Layout of Keys in NAS Mode	29
	10-Key Pad	31
	Keys Available in 10-Key Pad Configuration	31
	Accessing the 10-Key Pad	32
	Layout of 10 Key Pad	32
	Mouse Function Mode	33
	Keys Available in Mouse Function Mode	33
	Accessing Mouse Function Mode	33
	Layout of Keys in Mouse Function Mode	34
	Mouse Click Lock	34
SECTION 7		
	<b>USING THE FINGER MOUSE AND ARROW KEYS</b>	<b>37</b>
	Activating the Mouse or the Arrow Keys	38
	Moving the Mouse Pointer	38
	Moving Slowly	38
	Moving Quickly	38
	Moving at High Speed	38
	Moving Diagonally	38
	Changing Mouse Speed Settings	39

Clicking the Mouse Buttons	39
Using the Arrow Keys to Move the Cursor	39
Moving the Cursor	39
Switching Back to the Finger Mouse	40
Mouse Click Lock	40
MOUSE Click Lock:	40
WINDOWS EXAMPLES:	40

## SECTION 8

<b>SPECIAL KEYS</b>	<b>41</b>
Switching Left and Right Function for Duplicate Keys: The L/R <i>Modf</i> Key	42
Changing DataHand <sup>®</sup> System Settings: Program Selection Keys	43
<b>SPECIAL KEYS, FEATURES AND OPTIONS</b>	<b>45</b>
Windows Keys ... 104 Keyboard	45
Cursor Keys	45
Mouse Nudge	45
Swap Alt and CTL Keys:	45
L/R ALT and CTL KEYS:	45
SwapThumb 'UP' Keys:	45
Foot Pedal Support:	46
PS/2 Mouse Enable:	46
DH-200 MODEL COMPATIBILITY:	46
Macintosh Users:	46

## SECTION 9

<b>COMMON QUESTIONS</b>	<b>48</b>
Questions and Answers	49

## SECTION 10

<b>WINDOWS NOTES &amp; SHORTCUT KEYS</b>	<b>53</b>
Shortcut Keys using EXCEL with DataHand	54
Shortcut Keys using Windows with DataHand	55
Shortcut Keys using WORD with DataHand	56
<b>GETTING MORE HELP</b>	<b>57</b>

## SECTION 1

# WHAT IS THE DATAHAND<sup>®</sup> SYSTEM?

The DataHand<sup>®</sup> System features a special pair of input devices called hand units. What makes the hand units so unique is that they combine and replace the functions of a flat keyboard and mouse, while maximizing your comfort and efficiency.



Figure 1. The Hand Units

The hand units were designed around the hands' most natural position. They do not force the hand to adapt to the device. Instead of making your fingers move to the keys, they bring the keys to your fingers.



## Advantages Of The DataHand® System

Using the hand units instead of a flat keyboard for computer input has many advantages. Here are some of them.

### Be Comfortable While Working

To increase your working comfort you can:

Reduce unnatural arm and elbow bends by tilting the hand units and spreading them comfortably apart.

Lean back in your chair while working by using the LapLander™ to place the hand units on your lap.

Adjust the arch of your fingers, relative to your hand, by moving the finger board up, down, forward or backward.

Rest your hands on the palm supports. The supports come in two sizes: large and small. They support your hands in a relaxed position and eliminate wrist motions.

See the *Ergonomic Suggestions* section for more details and an illustration.

### Type With Only Slight Finger Movements

To type on the hand units, you move the fingers only slightly in one of 5 directions: north, south, east, west and straight down. You move the thumbs in 4 directions: east, west, straight down and up. This reduces the repetitive downward pecking motions of fingers required to operate a flat keyboard and therefore reduces repetitive stress exposure.

### Increase Your Efficiency

You can easily touch-type all the keys on the hand units. Minuscule finger movements access all the standard keys, the function keys and the mouse, so blind reaches are eliminated. This reduces finger workload and can also boost your productivity.

## Hardware Compatibility

The DataHand<sup>®</sup> System plugs into all personal computers (ATs and newer) and compatibles, without the need for additional hardware or software. The following computers are also supported:

- Apple Macintosh, with an adapter for the Apple Desktop Bus (ADB) or Universal Serial Bus (USB)
- Hewlett Packard X-Terminal
- IBM PS/2
- IBM RS6000
- IBM 3270 mainframes
- NCD 101 X-Terminal
- Silicon Graphics' Indy and Indigo II (currently being tested)
- SUN (usable type-5 keyboard using SUN's interface converter)

If you have a computer that is not on this list, and it has a keyboard that you can unplug, DataHand<sup>®</sup> Systems, Inc. can set up a custom adaptation of the DataHand<sup>®</sup> System to your machine. To discuss customization services, contact DataHand<sup>®</sup> Systems, Inc. by using the reference in the *Getting More Help* section of this manual.

Note: The right hand unit contains firmware that allows the hand units to be connected to your particular computer. Utilizing optional adapters the hand units can be connected to different types of computers, such as Macintosh or Sun Systems.
--

## Software Compatibility

Any software that runs on your computer will be compatible with the DataHand<sup>®</sup> System. By pressing the appropriate keys or key combinations on the hand units, you can perform the same functions you performed using a flat keyboard.

If you have a question about how your software is behaving with the hand units, first read the manual for your software and the *Using the Hand Units* and the *Common Questions* sections in this manual. If you still have a question, contact DataHand<sup>®</sup> Systems, Inc. using the reference in the *Getting More Help* section.

## Care and Maintenance

The DataHand Ergonomic Keyboard requires cleanliness as does all electric/electronic devices. Foreign material and dust can cause the keys to not function or stick open causing multiple characters. Periodically cleaning with canned air (found in most computer supply stores) will clear the key gaps of foreign material and maintain normal operations.

The Palm pads may be removed and washed in a dishwasher.

## SECTION 2

# GETTING STARTED

This section identifies and describes the parts of the Professional II™. It instructs the user how to connect the hand units to your computer and presents outlined diagrams of the hand units. This section also explains the warranty that correlates with the DataHand® System purchase. With the information in this section, the user has enough information to acquaint themselves with the hand units to successfully begin using the DataHand System.

## Checking the Parts in Your Shipment

The checklist below describes the parts in your shipment. If any parts are missing or damaged or to order replacement parts, contact DataHand® Systems, Inc. customer service using the reference in the *Getting More Help* section of this manual. The parts will be sent as soon as possible.

Note: The DataHand® System does not contain a separate mouse. The mouse function is included in the keys operated by the index fingers on the hand units.

PARTS CHECKLIST		
Part Name	Description	Order Number
<input checked="" type="checkbox"/> <b>Hand units:</b> Left and right	The hand units are contoured for each hand and contain finger wells with keys for each finger. The serial number of your system is on the underside of each hand unit. <i>See Figure 2 for a diagram of the right hand unit.</i>	Left hand unit = A240L Right hand unit = A240R
<input checked="" type="checkbox"/> <b>Palm Supports:</b> Left and right	The palm supports are removable parts of the hand units. They come in one of 2 sizes: large (L) or small (S). <i>See Figure 2 for a diagram of the right hand unit.</i>	Left support (L) = 247LL Right support (L) = 247RL Left support (S) = 247LS Right support (S) = 247RS
<input checked="" type="checkbox"/> <b>LapLander™:</b> Use is optional	The LapLander™ is a foam-lined board to which you can bolt the hand units. <i>See Ergonomic Suggestions page 13 for details.</i> <b>WARNING: DO NOT REMOVE THE FOAM PADS AND REATTACH TO THE LAPLANDER --- THE SCREWS WILL BREAK THROUGH THE PLASTIC TOP.</b>	B70000001
<input checked="" type="checkbox"/> Foam Wedges: Two	The foam wedges can be used to tilt the hand units when they are bolted to the LapLander™. <i>See Ergonomic Suggestions page 13 for details.</i>	F70000002
<input checked="" type="checkbox"/> DataHand System User Guide	The manual you are reading is the user manual. It explains how to install the DataHand® System.	U-200M
<input checked="" type="checkbox"/> DataHand System Training Guide	The Training Guide provides step by step instructions with practice drills.	U-300M

## Identifying the Components of the Hand Units

The following diagram labels the parts of the right hand unit. The left-hand unit mirrors the right hand unit, except it does not have parts 9, 10 and 13.

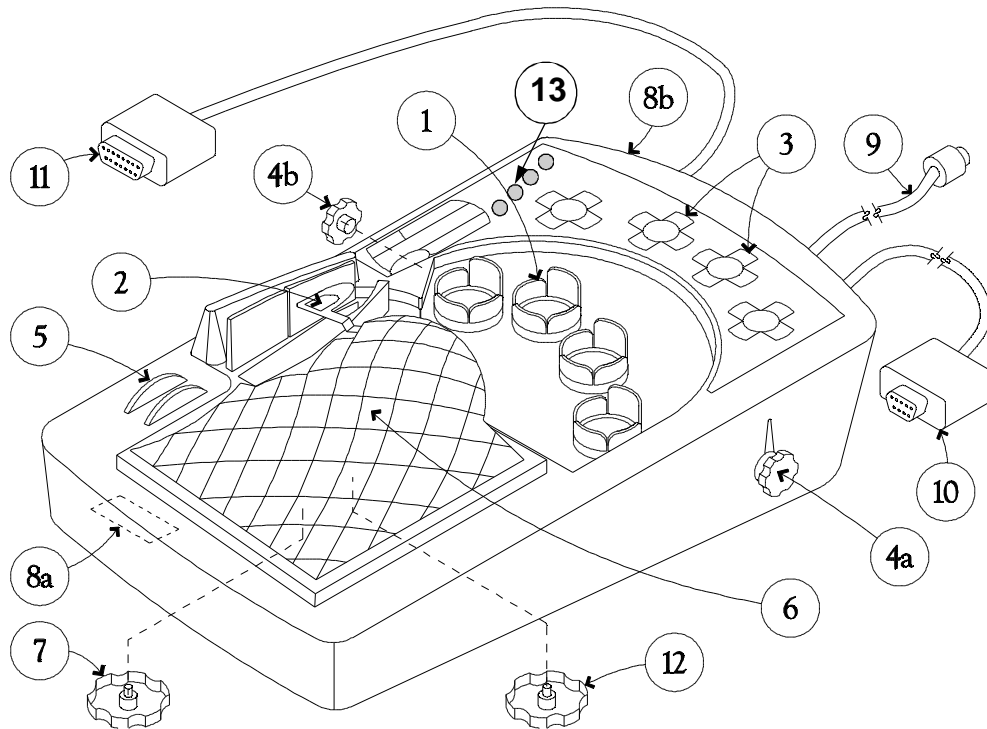

**Figure 2. Diagram of the Right Hand Unit**

- (1) Finger well surrounded by keys.
- (2) The direct access key above the thumb.
- (3) Template of key names color-coded by mode.
- (4a,b) Nuts for raising or lowering the internal finger board, one on each side of the hand unit.
- (5) Dials for moving the left and right sides of the finger board, forward or backward.
- (6) Ribbed rubber palm support, removable and available in two sizes: Large and small.
- (7) Bolt that attaches the hand unit to the optional LapLander™.
- (8a,b) Tilt feet on the underside of the hand unit.
- (9) Keyboard-to-computer cable. This is the 6-pin mini din connector.
- (10) Mouse cable. This is the serial cable with a 9-prong female terminator. (If PS/2 mouse version, cable has a 6-pin round terminator like part #9).
- (11) Cable that connects the right and left hand units to each other.
- (12) Bolt that attaches the palm support to the hand unit.
- (13) Four mode indicator lights.

The serial number for your system is on the bottom of both hand units.

## Positioning the DataHand Ergonomic Keyboard

The DataHand System operates with infrared devices. For stable operation:

- 1) Keep the units out of direct sunlight: such as near office windows;
- 2) Place work or desk lamps at least 3 feet away from the units; and
- 3) If work or desk lamps are within three feet, do not aim the light directly at the units.

## Connecting the Equipment

To connect the DataHand® System to your computer, remove the old input devices and replace them with the hand units, but you must follow the instructions below to connect the equipment properly.

### Step 1. Preparing the computer.

Power down your computer. This is an important step because the mouse might not work if you connect the equipment before you shut off the computer.

### Step 2. Preparing the hand units and using the LapLander™.

The DataHand Ergonomic Keyboard is shipped mounted to the LapLander. **NOTE:** If the unit is removed from the LapLander, **do not reinstall the bolts (#12 in Figure 2, #4 in Figure 3) because the threaded stud is too long and will damage your unit.**

Make sure that the cable that attaches the two hand units to each other is securely in place.

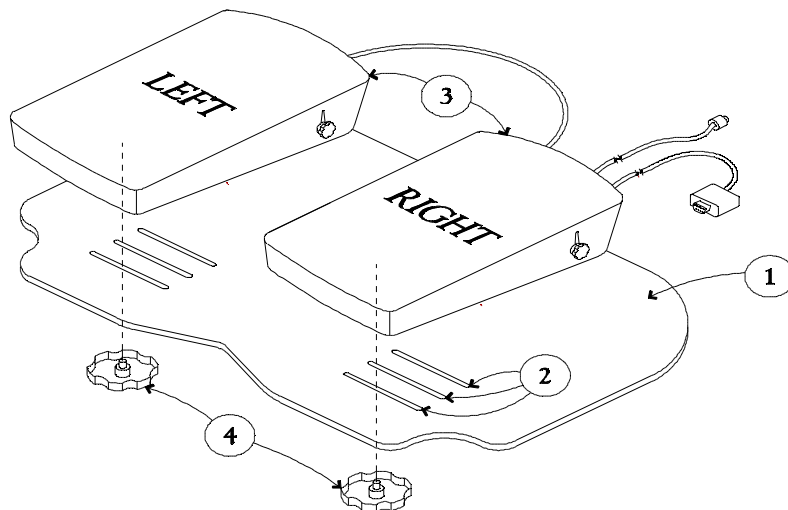

Figure 3. Bolting the Hand Units to the LapLander™

- (1) LapLander™
- (2) 1 Slot
- (3) Schematic left and right hand units
- (4) Bolts that attach the hand units to the LapLander™
- (5) Foam Pads

**Step 3. Removing your old keyboard and mouse.**

With your computer turned off, unplug your old keyboard and mouse, if you had one, from the back of the computer making note of which ports you used.

**Step 4. Identifying the keyboard-to-computer and mouse cables.**

Identify the following two cables that emerge from the right hand unit:

The keyboard-to-computer cable (#9 in Figure 2) has a 6-prong round terminator.

The mouse cable (#10 in Figure 2) has either a 9-prong female terminator or a 6-prong round terminator, depending on whether you have a serial or PS/2 mouse.

**Step 5. Connecting the keyboard-to-computer cable.**

Plug the cable with the 6-prong terminator into the computer port from which you removed your keyboard in Step 3.

**NOTE: Some notebook computers such as the IBM Thinkpad, require a “Y-Connector” to connect an external keyboard such as the DataHand Ergonomic Keyboard to a common single dual port for the mouse and keyboard connection.**

**Step 6. Connecting the mouse cable.**

If you had a serial mouse, your cable has a 9-prong terminator. Plug it into the computer port from which you removed your mouse in Step 3. This will be one of the serial ports, COM 1 through COM 4.

If you had a PS/2 mouse, your cable has a 6-prong round terminator. Connect the cable to the PS/2 mouse port.

**Step 7. Starting your computer.**

Turn on your computer.

*The green light on the right hand unit should go on indicating you are in Normal mode.*

<p>Note: The right hand unit contains firmware that allows the hand units to be connected to a IBM PC computer. To connect the keyboard to other computers such as Macintosh or Sun, you will need an appropriate converter ... contact us for available adapters.</p>
--



### **Attention**

Your DataHand® System has been tested and found to comply with the limits for a Class B digital device, pursuant to Part 15 of the FCC Rules. These limits are designed to provide reasonable protection against harmful interference when equipment is operated in a commercial environment. This device generates, uses, and can radiate radio frequency and, if not installed and used in accordance with this instruction manual, may cause harmful interference to radio communications. However, there is no guarantee that interference will not occur in a particular installation. If this device does cause harmful interference to radio or television reception, which can be determined by turning the device off and on, you are encouraged to try to correct the interference by one of more of the following measures:

- Reorient or relocate the receiving antenna.
- Increase the separation between the equipment and receiver.
- Connect the equipment into an outlet on a circuit different from that to which the receiver is connected.
- Consult the dealer or an experienced radio/TV technician for help

## SECTION 3

# POSITIONING YOURSELF

This section present the proper positioning of the units to maximize correct ergonomic style as well as attain the most efficient results. Four steps are provided in order to increase your working comfort. Together with your chair and armrests or LapLander™, you can obtain proper hand, arm and upper body support.

## Ergonomic Suggestions

The following suggestions are meant to increase your working comfort. Remember that frequent rest breaks and exercises are advised after a period of typing on any keyboard.

### Using The LapLander™

Your Professional II™ comes attached to an optional LapLander™. The LapLander™ is designed for the user to position the hand units on the lap as opposed to placing them on the desk. The LapLander™ is made of a flat-surfaced board with foam attached on the bottom in order to provide cushion while resting the Professional II™ on your lap. If you choose to use the Professional II™ without the optional LapLander, the hand units should be removed from the LapLander™ and placed on the desk.

**WARNING: DO NOT REMOVE THE FOAM PADS AND REATTACH TO THE LAPLANDER --- THE SCREWS WILL BREAK THROUGH THE PLASTIC TOP.**

#### Step 1. Positioning your chair, arms and legs.

Your hands and wrists should be in line with each other. Your wrists should not be twisted or bent. Arm rests on the sides of your chair can help to support your arms and increase your comfort.

*If you use the optional LapLander™:*

You can lean back in your chair as you type, but remember to position yourself so that your wrists are straight.

*If you do not use the optional LapLander™:*

Place the hand units on the table in front of you. Adjust your chair so that when you sit you will have angles of 90 degrees or more at your knees, hips-to-thighs and elbows. If your chair has arm rests, you may find you are now able to use them to help support your arms and upper body while you are using the DataHand® System.

### Warning

**Although this DataHand® System was designed with the goal of reducing injury exposure, the prolonged use of any manually-operated data entry device (including this DataHand® System) may result in repetitive stress injury or related injury.**

If pain, discomfort, numbness or tingling in the hands or arms is experienced during or as a result of use, consult an appropriate medical professional and reduce usage until discomfort is eliminated. *Avoid other activities that may aggravate your condition, such as using other less ergonomic keyboards.* To reduce your risk of repetitive stress injury, please see the ergonomic guidelines in the *Ergonomic Suggestions* section of this user manual.

Take frequent breaks from typing and maintain good health habits.

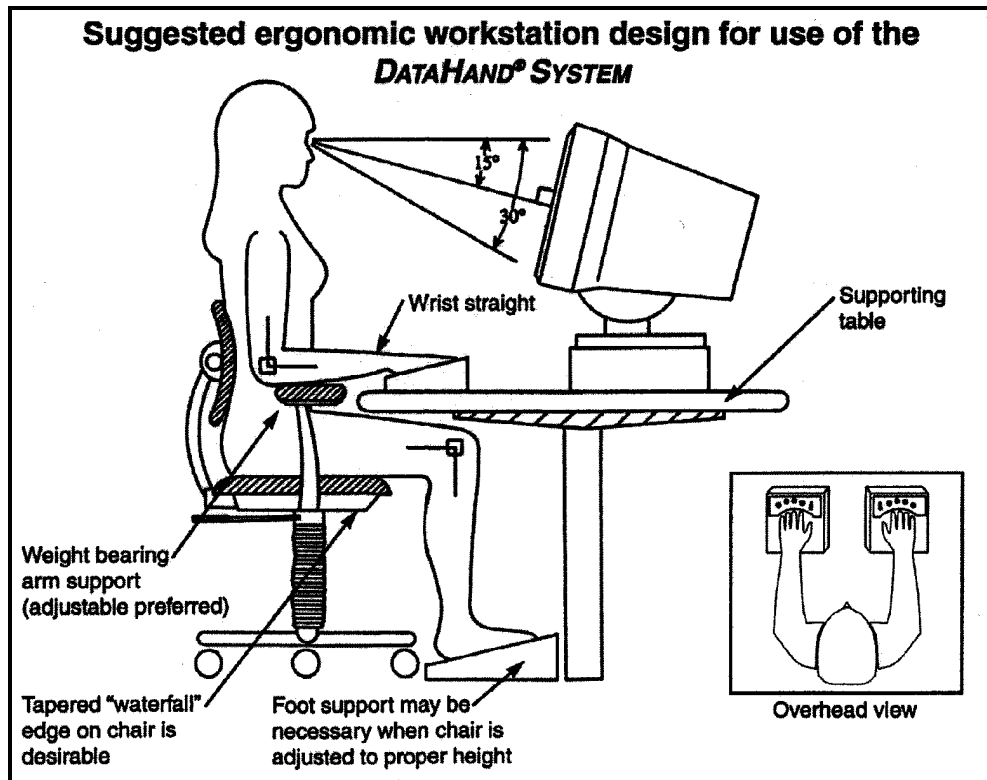

Figure 4. Ergonomic Suggestions

**Step 2. Finding a comfortable position for the hand units.**

*If you use the optional LapLander™:*

The hand units are in a lower position than they would be if they were on the table in front of you. Consequently, they will be closer together than shoulder-width. You can slide the hand units through the slits in the LapLander™ as close as or as far apart as you want. You can also swivel the hand units.

*If you do not use the optional LapLander™*

Although you might be accustomed to keeping your hands close together when typing at a keyboard, in the long run placing the hand units shoulder-width apart will increase your comfort. It will maintain the forearms at a comfortable angle to the shoulders and will prevent unnatural curving of the hands and arms around the body that occurs when using a flat keyboard.

### Step 3. Adjusting the internal fingerboard.

Everyone's fingers are different. You can raise, lower or tilt the finger board to adjust the arch of your fingers relative to your hand:

- a) Loosen the nuts (#4a and #4b in Figure 2) on the sides of each hand unit.
- b) Rest one hand on its hand unit.
- c) With your other hand, slide the finger board around until it barely touches the finger tips of your stationary hand.
- d) Use the dials on the hand unit (#5 in Figure 2) to move the right and left sides of the finger board forward or backward.
- e) Tighten the nuts.
- f) Repeat steps a) through e) for the other hand.



Figure 5. View of the Tilt Feet

### Step 4. Using the foam wedges or tilt feet to tilt the hand units.

You might be more comfortable elevating the thumb side of each hand unit.

*If you use the optional LapLander™:*

Insert the foam wedges between the hand units and the LapLander™ on the thumb sides of the hand units.

*If you do not use the optional LapLander™:*

Raise the tilt feet (#8a and #8b in Figure 2) under the thumb sides of the hand units. The feet have 2 positions. You cannot do this if the hand units are attached to the LapLander™.

## SECTION 4

# TRAINING AIDS

Several training aids were shipped with the DataHand® System, and if you wish, you can make copies of these aids.

## Using the Training Aids

The training aids have four parts:

Instructions on how to install the DataHand<sup>®</sup> System to your computer.

A fold-out explaining the parts of the DataHand<sup>®</sup> System.

Set of templates to use while learning the DataHand<sup>®</sup> System.

Series of lessons to help you to learn how to use the mouse/function mode, numeric mode (NAS), alpha mode (NORMAL) and 10-key mode.





## SECTION 5

# LEARNING TO USE THE HAND UNITS

Learning to use the hand units can be exciting and rewarding. This section teaches you how to be efficient while learning to adapt a new skill and how to set reasonable performance expectations. It also teaches you how to move your fingers when operating the different keys. Keep in mind that practice is essential to master any new skill.

## Learning a New Skill

You can learn to use the hand units most easily by:

Setting reasonable performance expectations.

Using the DataHand® System Training Aids shipped with the DataHand® System if you have Microsoft Windows®.

Positioning yourself comfortably and taking frequent breaks (see the section *Ergonomic Suggestions* for recommendations on positioning yourself).

Avoiding switching back and forth between a flat keyboard and the hand units if you find switching to be confusing.

If this is your first experience typing, or if you want to practice typing using the hand units, you can install a program such as Typing Tutor V™ (Simon and Schuster) or Dvorak on Typing™ (Interplay). These commercially available typing programs work well with the DataHand® System. They provide practice exercises and feedback on accuracy and speed. They can be purchased from any office supply store at a moderate price and run on a variety of computers.

If you are converting from a flat keyboard to the hand units, it might be best to not switch between the two types of keyboards more than necessary. Frequent switching might be confusing while you are first learning. In addition, if you are recovering from a hand injury using a flat keyboard might prolong healing or cause more injury.

Whether you are converting from a flat keyboard or learning to type for the first time, your comfort level with the DataHand® System will continually improve with use. You can gain considerable proficiency over time. Over a period of time, almost every DataHand® System user finds it to be faster and more comfortable than any other keyboard.

## Setting Reasonable Performance Expectations

Many new users wonder why they are not able to attain their previous typing speeds on the hand units in just a few hours. Becoming proficient in any new skill takes commitment and practice. Eventually your typing speeds on the hand units can *exceed* those attained on a flat keyboard.

Finding time to learn and practice is essential. Uninterrupted training time will yield the best results. Studies show that 20 or 30 minute learning segments are most beneficial, but you can gradually increase these times as your

comfort level increases. A total of 2 hours per day for 2 weeks is recommended. Most users report that it takes a total of 15 to 50 hours of practice to become well versed with the system.

You can also use some of your practice time to play games on the computer that allow you to become accustomed to the sensitivity of the hand units' keys and finger mouse.

## Moving Your Fingers to Press the Keys

When you place your hands on the hand units, each finger should be able to move freely in 5 directions: north, south, east, west and straight down. The keys that you activate by pressing straight down are called the well keys.

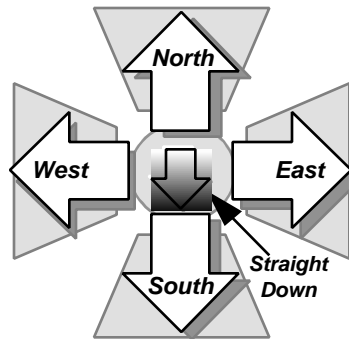

Figure 6. Finger Motions

Note: In the following sections, names of keys are bolded. For example, "On the left thumb, light pressure activates **SHIFT**."

## Moving Your Thumbs to Press the Keys

Your right thumb should be able to move freely east, west, southwest, and straight down to its well key and up to its direct access key. Your left thumb should be able to move freely east, southeast, west, straight down to its well key and up to its direct access key.

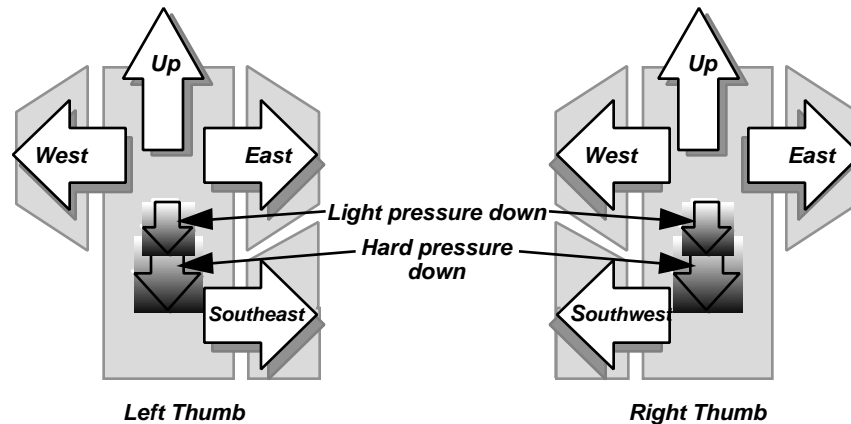

Figure 7. Thumb Motions

The well keys directly beneath the thumbs actually have two positions:

Pressing the left thumb lightly activates **SHIFT**. Hard down pressure activates the second position, **CAP LOCK**, and the lock light over the left thumb goes on; the next cycle of hard down pressure will deactivate **CAP LOCK** and the lock light will go out.

Pressing the right thumb lightly activates **NAS SHIFT**. Hard down pressure activates the second position, **NAS LOCK**, and the lock light over the right thumb goes on; the next cycle of hard down pressure will deactivate **NAS LOCK** and the lock light will go out.

The keys above the thumbs are called the direct access keys. You activate these keys by lifting up the thumbs. The use of these keys is explained in the next section *Three Modes of Operation*.

## SECTION 6

# THREE MODES OF OPERATION

In section 5 you were introduced to the various finger movements in relation to the keys. In this section you will learn how to use the Professional II™ to access all of the keys and functions of the traditional flat keyboard. The Professional II has 4 different operating modes. You will explore these modes in order to discover the Professional II's™ greatest potential.

## Accessing Different Modes



The hand units operate in three modes as indicated on the right hand unit:

1. NAS (Numbers and Symbols) mode
2. Normal mode
3.  F (Mouse Function) mode

In addition, there is a fourth label on the right hand unit: 10-Key. This stands for 10-Key pad, which is really a subset of NAS mode. You know you are in a particular mode when the appropriate indicator light is on. All the modes and the 10-Key pad are explained in detail in the following sections.

Each mode enables you to access a group of keys. If you want to access a key that is not available in the mode you are in, you must switch to the mode in which the key is available. Together, the modes of operation allow you to access all the keys and functions of a standard flat keyboard without lifting your hands from the hand units.

The templates on the hand units indicate in which modes the keys are available by using a color code. The chart below lists the modes, their associated color codes and the available keys.

DataHand® System Modes		
Mode	Color Code	Keys
NAS	Blue Keys (Orange mode light)	Numbers <b>0 – 9</b> The following punctuation marks and symbols: <b>&amp; ^ : x' ( ) ; . ? ! ~ @ # &lt; &gt; % \$ - + = / *</b> <b>NUM LOCK, 10-K ON, 10-K OFF</b>
Normal	Green Keys (Green mode light)	Letters <b>a - z</b> and <b>A - Z</b> The following punctuation marks: <b>, ' : . ; ?   " ` { } [ ] \ /</b>
 Function	Yellow Keys (Yellow mode light)	Function keys <b>f1 - f12</b> Arrow and mouse key toggles  and  The arrow keys <b>← → ↑ ↓</b> The finger mouse arrows <b>← → ↑ ↓</b> The following function keys: <b>HOME, END, PAGE UP, PAGE DN, PAUSE, INS, HELP, PRINT, m.b.1, m.b.2, m.b.3, L/R MODF, OPT/CT, NUM LOCK and SCROLL LOCK.</b>
10-Key (a subset of NAS)	Pink keys (Orange and red mode lights)	Numbers of the 10-Key pad <b>00</b> and <b>0 - 9</b> The following operators: <b>= - * / + ( ) ' \$ . &amp;</b>

## Using Protected Mode Keys

**FUNCTION KEY PROTECTION:** The FUNCTION keys may only be accessed by holding the Function direct access key (right thumb key – up) and pressing F1 through F12. F13 through F24 keys are accessed by holding down SHIFT and at the same time operating F1 through F12 respectively. Any function key accompanied by a modifier (i.e. ALT, CTL or SHIFT) is automatically sent along with the modifier.

**TURNING OFF FUNCTION KEY PROTECTION:** The user may toggle between protected and unprotected function keys. Go to Program Mode (see User Guide, page #44) and press letter 'I' as your Program Selection key. This disables the protection until the user toggles the command again. The REV message will now show a 'f' in the last position if the protection is enabled.

**MISCELLANEOUS KEYS PROTECTED:** The PRINT SCREEN, NUMLOCK, TEN-OFF, TEN-ON and LEFT/RIGHT MODIFIER keys are protected by default on power up. If the KEY is available in FUNCTION mode then the FUNCTION ACCESS key unlocks that key. If the key is found in the NAS mode, the NAS LOCK (direct access) key unlocks the key and completes the necessary task.

**TURNING OFF PROTECTION:** The user may toggle between protected and unprotected miscellaneous keys. Go to Program Mode (see User Guide, page #44) and press letter 'K' as your Program Selection key. This disables the protection until the user toggles the command again. The Rev message does not show the state of this protection mode.

## Keys Available in Several Modes

All the keys operated by the thumbs, as well as **ENTER**, **DELETE** and **ESCAPE**, are available in all modes. The functions and the positions of these keys stay the same in all modes.

The keys available in all modes are indicated in white on the template.

The **ESCAPE** key (**ESC**) is one of the keys available in all three modes. When this key is activated simultaneously with the **CONTROL** key (left thumb lower right), the combination emulates the Microsoft Windows® direct access key now available on some keyboards. A WINDOWS compatible key layout (104 keyboard) may be selected (see User Guide, page #44). In the **NORM** and **FUNC** modes the **WINDOWS** key will be in place of the extra **ENTER** key (Right Ring East) and the **APPLICATIONS** Key will be found in the **NAS** mode.

Note: As described in the section, *Moving Your Thumbs to Press the Keys*, the

thumbs can access two keys each in the down position. You activate one key by applying light pressure and the other key by applying a harder pressure.

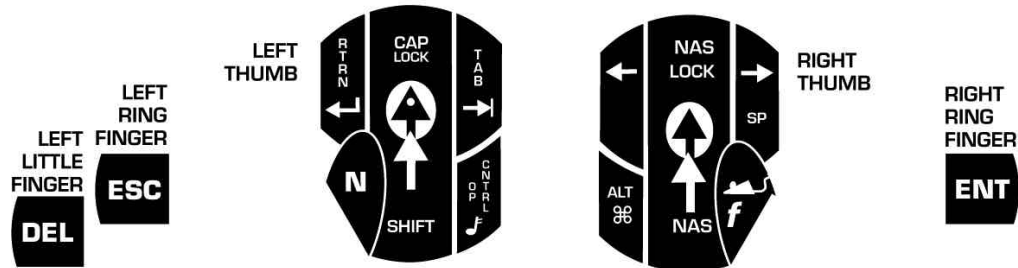

Figure 8. Keys Available in all Modes

Some keys are available in two modes. The punctuation keys, such as the colon and the semi-colon, occur in Normal and NAS modes. Their locations are the same in both modes.

Other keys that occur in two modes have different locations in each mode, such as the operator keys in the NAS and 10-Key modes.

The illustrations on the following pages show the template for all three modes. Each mode is illustrated and described in detail in the sections that follow.

## Normal Mode

When you turn on your computer, the system comes up in Normal mode.

### Keys Available in Normal Mode

This is the mode to type the letters of the alphabet. This is also the mode to access the punctuation symbols that usually occur on the middle three rows of a standard flat keyboard, such as the apostrophe <'>, quotation marks <">, comma, period and colon.

### Accessing Normal Mode

To enter Normal mode from any other mode, lift the direct access key above the left thumb. The green indicator light on the right hand unit should go on.

Figures 9 and 11 show all the letters and symbols each finger can



type in Normal mode. The letters and symbols that are accessed in Normal mode are indicated in green on the template above the finger wells.

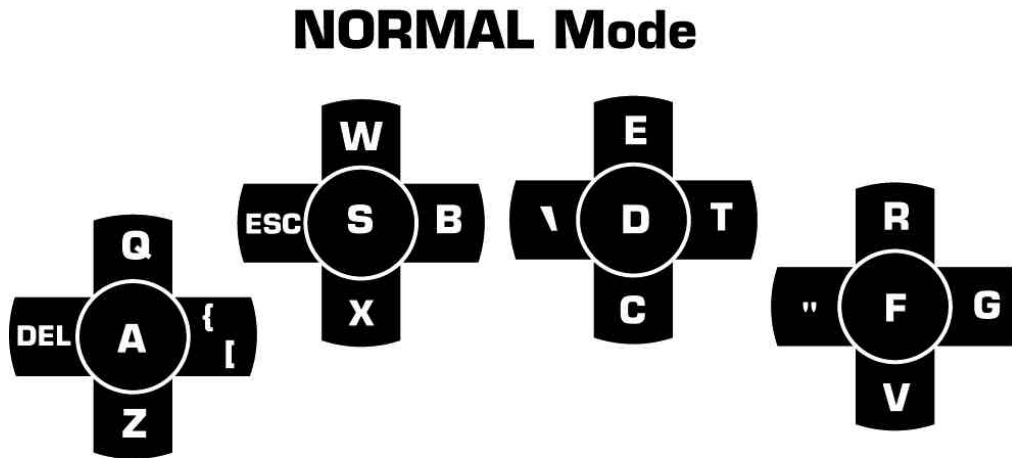

Figure 9. Left Hand in Normal Mode

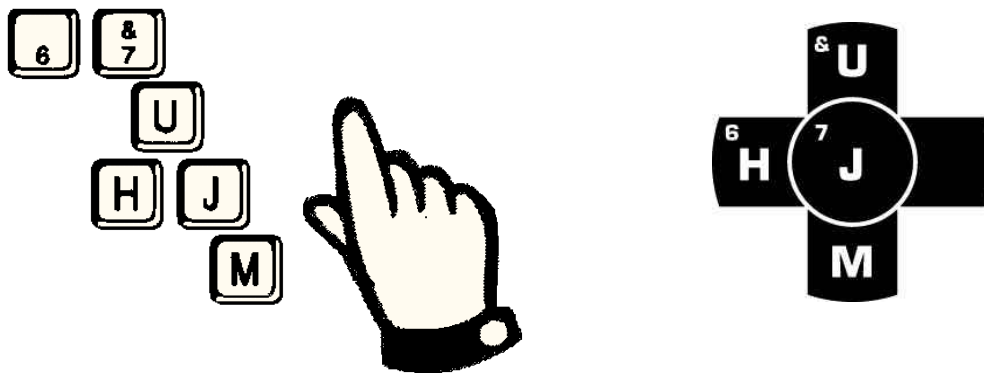

Figure 10. Layout of Right Index Finger Keys on a Flat Keyboard and on a DataHand® Keyboard

### Layout of Keys in Normal Mode

The layout of keys on a standard flat keyboard is called QWERTY, for the sequence of letters in the third row of the left hand. If you are converting from a standard flat keyboard to the hand units, you will find the mapping of keys to be similar. For example, on a standard flat keyboard the right index finger types the letters U, J, M and H. Using the hand units, the right index finger types the letters U, J, M, H and the apostrophe ('). On the hand units, each finger accesses the same letters of the alphabet as it does on a standard flat keyboard, except for the letters B, T, N and Y.

Figure 10 compares the letters on the standard keyboard and the DataHand® Systems keyboard typed by the right index finger.

## NORMAL Mode

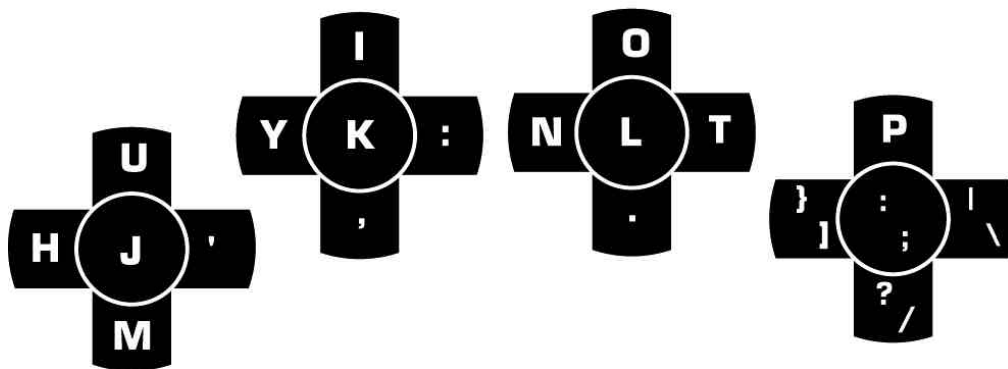

Figure 11. Right Hand in Normal Mode

## **NAS Mode**

NAS (Numbers and Symbols) mode contains commonly used numbers and symbols, including those of the 10-Key pad.

### **Keys Available in NAS Mode**

NAS mode is the mode in which you type the numbers zero through nine, and the symbols that are found at the top row of a standard flat keyboard: such as the exclamation point (!), dollar sign (\$) and ampersand (&).

NAS mode is also the mode from which you access the 10-Key pad. You use the **10 K&P ON** and **10 K&P OFF** keys on the east and west of the right pinky finger to switch between NAS mode and the 10-Key pad. See the next section for more details on the 10-Key pad.

### **Accessing NAS Mode**

To lock into NAS mode, press **NAS LOCK** (*right thumb, hard pressure, well key*). The NAS Lock light under the right thumb goes on. To exit NAS mode activate either DA key (RT or LT thumb up). To type just a few characters, instead of locking into NAS mode, you can shift into NAS mode. To shift, press NAS (*right thumb, light pressure, well key*). Continue to hold this key with light pressure until you finish typing the NAS mode characters.

If you have activated the 10-Key pad and then switch to Normal or Mouse Function mode, when you return to NAS mode, the 10-Key pad is automatically switched on. To access the keys available in NAS mode, you must turn off the 10-Key pad.

The orange right hand NAS light is on when in NAS mode.

### **Layout of Keys in NAS Mode**

Figures 12 and 13 show all the keys available in NAS mode. The names of keys available in NAS mode are indicated in blue on the template above your fingers.

## NAS Mode

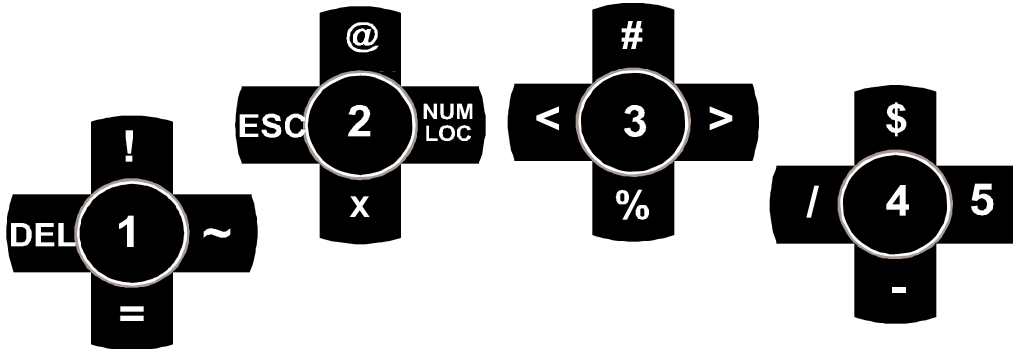

Figure 12. Left Hand in NAS Mode

## NAS Mode

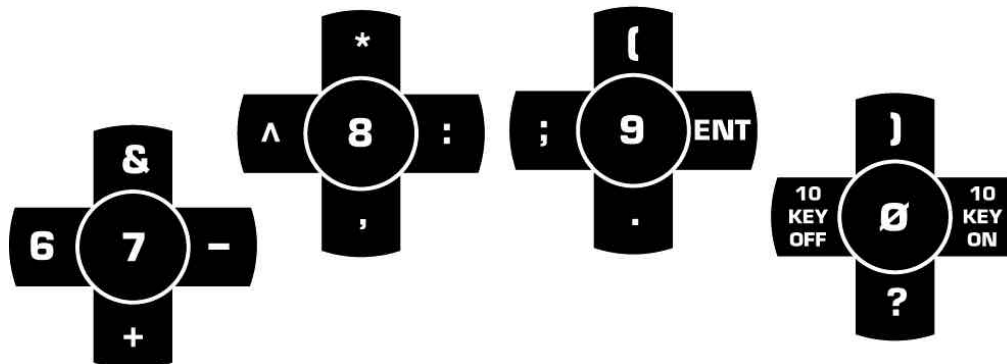

Figure 13. Right Hand in NAS Mode

## 10-Key Pad

Because you must access the 10-Key pad from NAS mode, the 10-Key pad is considered a subset of NAS mode.

### Keys Available in 10-Key Pad Configuration

Although the numbers may appear to be the same, some special applications distinguish between the numbers on the 10-Key pad and the numbers on the top row of the main part of a flat keyboard. When you use the numbers in NAS mode, it's like using the numbers on the top row of a flat keyboard. The same is true when you use the 10-Key pad numbers. However, if you turn on **NUM LOCK**, these number keys will send the 10-Key pad keys.

The keys available on the 10-Key pad are the numbers (**00** and **0 - 9**) and the operators of addition (+), subtraction (-), multiplication (\*), division (/), equals (=), parentheses, dollar sign (\$), period and ampersand (&).

In addition, the arrow keys on the left index finger are available for navigation.

Note: Some keys (such as @, !, #, <, > and %) are not shown in pink here and in the other guides as on the actual display of the left hand unit but are shown in NAS mode blue. The rule for the left hand is: When in 10-Key mode where a character or symbol is not shown in pink, the character or symbol shown in blue will be accessed.

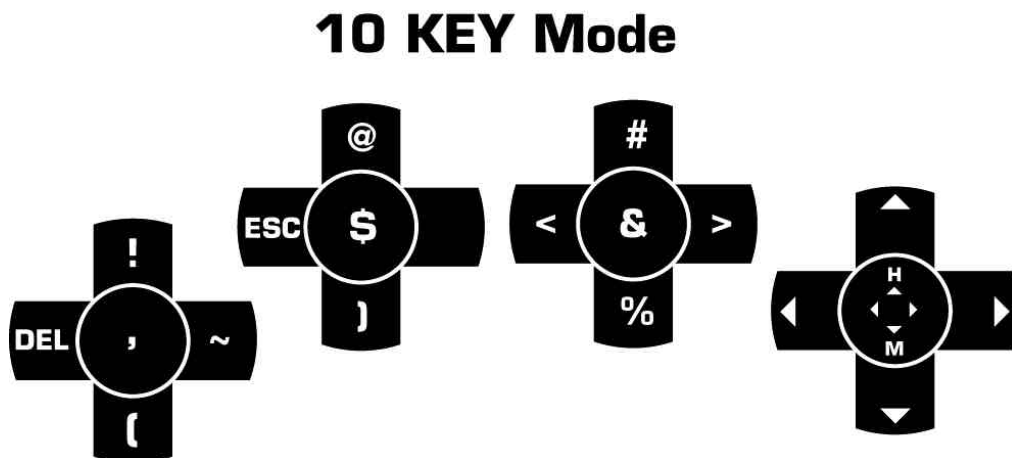

Figure 14. Left Hand in 10-Key Configuration

### Accessing the 10-Key Pad

To access the 10-Key pad, press the **10-Key ON** key (*right pinky, east*) in NAS mode. You stay in 10-Key configuration, in this and future work sessions, until you press the **10-Key OFF** key (*right pinky, west*) to return to NAS mode. This means that if you do not press the **10-Key OFF** key and you go to another mode, such as Mouse Function mode or Normal mode, when you return to NAS mode, you will automatically be in 10-Key configuration.

You are in 10-Key configuration when the red 10-K&P light and the orange NAS indicator light on the right hand unit are on at the same time.

Technical Note: If **NUM LOCK** is on, the number keys in 10-Key mode send scan codes of the numeric keypad normally found on the right side of a flat keyboard. If **NUM LOCK** is off, the keys send scan codes of the numeric keys at the top row of a flat keyboard. However, you get numbers whether **NUM LOCK is on or off**. You can engage **NUM LOCK** in either Mouse Function or NAS mode, and the Num Lock light under the left ring finger will go on, and the DataHand® System sends a **NUM LOCK** code to the computer (required by some program for special features).

### Layout of 10 Key Pad

Figures 14 and 15 show all the keys available in the 10-Key pad. The names of keys available in 10-Key pad configuration are indicated in pink on the template above your fingers. (If a 10 Key (pink) symbol is not shown, the NAS (blue) symbol applies.)

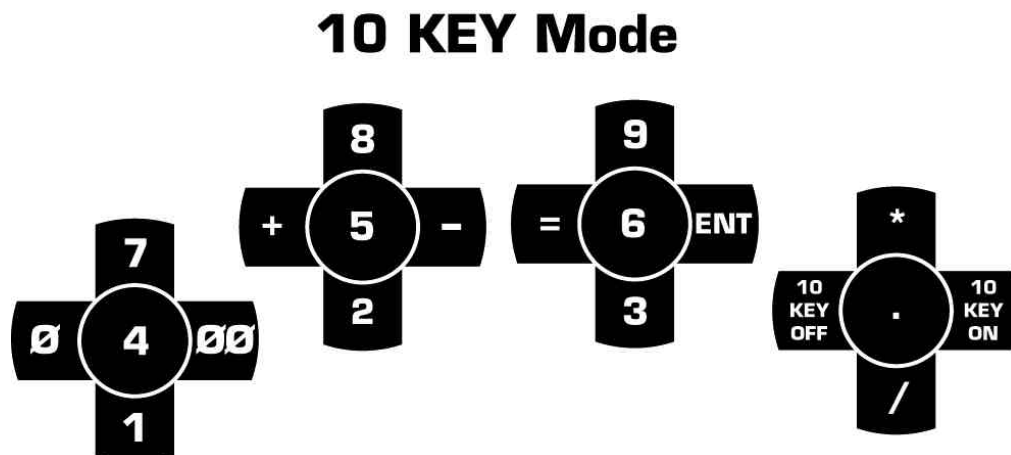

Figure 15. Right Hand in 10-Key Configuration

## Mouse Function Mode

Use this mode to access the navigation and special function keys. For more about the Mouse and Cursor functions see Section 7, *Activating the Mouse or the Arrow Keys*, pg. # 38.

### Keys Available in Mouse Function Mode

In Mouse Function mode, you can access the DataHand® System finger mouse and the directional arrow keys. These keys allow you to navigate the mouse pointer or cursor on the screen. The three mouse buttons, **mb1**, **mb2**, **mb3**, are also available.

In addition, you can access function keys f1 through **f12**.

You can also access **HOME**, **END**, **PAGE UP**, **PAGE DN**, **PAUSE**, **INS**, **HELP**, **PRINT**, **L/R MODF**, **OPT/CT**, **SCROLL LOCK** and **NUM LOCK**.

Note: HOME is only available with the Arrow Keys activated (see Section 7).

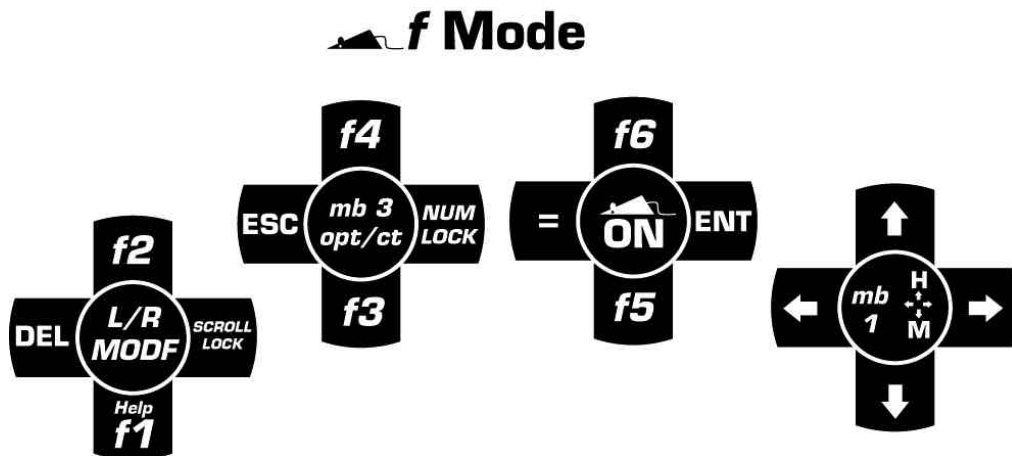

Figure 16. Left Hand in Mouse Function Mode

### Accessing Mouse Function Mode

To enter Mouse Function mode from any other mode, lift the direct access key above the right thumb.

You are in Mouse Function mode when the yellow indicator light on the right hand unit is on.

**Layout of Keys in Mouse Function Mode**

Figures 16 and 17 show all the keys each finger can use in Mouse Function mode. The names of keys available in Mouse Function mode are indicated in yellow on the template above your fingers.

The PRINT key requires a double strike to send the key to the PC. This helps protect from accidental print commands.

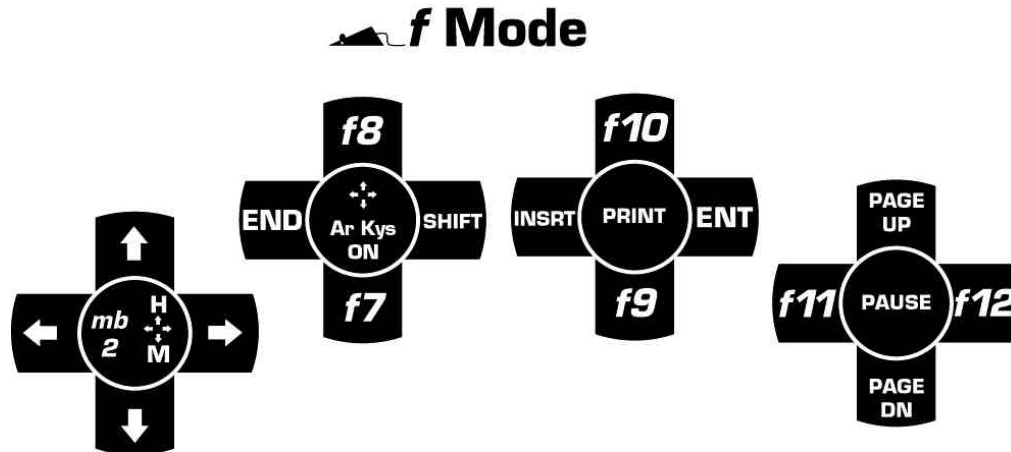

Figure 17. Right Hand in Mouse Function Mode

**Mouse Click Lock**

**MOUSE Click Lock ("Sticky" Mouse Buttons):** Hold the Function Mode direct access key up and press either the right or left mouse buttons. To release hit either right or left mouse button or any other key that is not a mouse movement key like ALT, SHIFT or CTL. Examples:

**To block text:** Enables the click lock for Left Button. Move mouse to hi-light the text.

**To delete text:** Press the delete key. The delete will release the mouse button and delete the text. Try this with CTL X for CUT or CTL C for COPY.

**To move text:** The user may also move the highlighted text by using click lock again. Now as you move the mouse the box of text is moved and can be dropped at a new location with by releasing as described above.

**Limitations:** The CTL key can not be used with the drag to duplicate an object selected because the button is released upon action from the CTL key. To copy, use the right mouse click-lock to move and duplicate the text, choose copy when the menu pops up.

**Using Key Combinations**

If you are using an application that requires you to use key combinations, such as the function keys in combination with **CNTRL**, **ALT** or **SHIFT**, apply



the keys in the same combination using the DataHand® System. Since these keys are available in all modes, applying these keys in combination should not present a problem.

For example, suppose an application requires you to press **CNTRL + F8** at the same time. To press these keys using the DataHand® System, first enter Mouse Function mode, then press **CNTRL** (*left thumb, southeast*) and **F8** (*right middle finger, north*) at the same time.

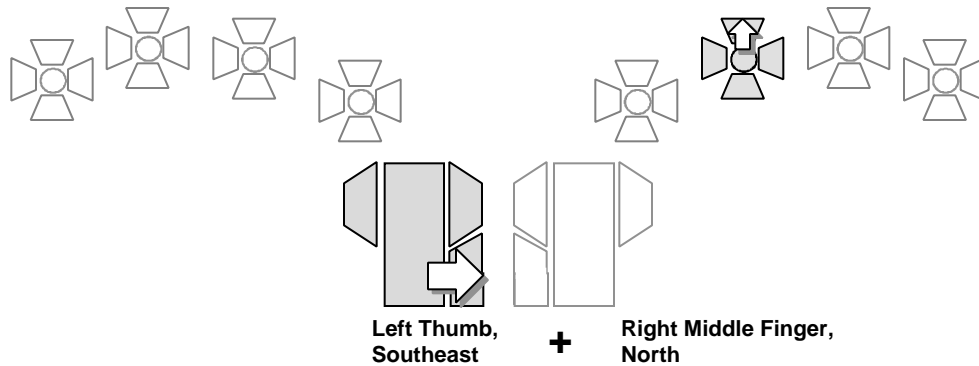

Figure 18. Key Combinations

If you must use a combination of keys that are not in the same mode or that are difficult to reach at the same time, define a macro to do this for you. See the section *Shortcut Keys: Creating Macros*, PG #**Error! Bookmark not defined.** for instructions.

For more about the Mouse and Cursor functions see Section 7, *Activating the Mouse or the Arrow Keys*, pg. # 38.



## SECTION 7

# USING THE FINGER MOUSE AND ARROW KEYS

While using the Professional II™, you have the option of navigating around your screen by using either the finger mouse or the arrow keys. This section will describe the operating capacities of these two functions.

## Activating the Mouse or the Arrow Keys

When the computer is first turned on, the mouse is automatically activated when in Mouse Function mode and is indicated by the yellow mouse light in the middle of the template for the left middle finger.

To switch to arrow key function, enter Mouse Function mode and press the arrow toggle  (right middle finger, well key). The yellow mouse light on the template for the left middle finger goes off. Note: The HOME key is available with the LT or RT Index Finger Down keys.

To switch back to mouse function, enter Mouse Function mode and press the mouse key  (left middle finger, well key). The yellow mouse light on the template for the left middle finger goes back on.

Note: The DataHand® System is not shipped with a mouse driver; it is intended to work with your existing mouse driver. Make sure that one of the following mouse drivers is installed on your computer: an IBM PS/2 or Microsoft-compatible driver for Microsoft Windows® and/or a DOS driver. The newer LOGITEC mouse drivers allow more than one mouse to be used at one time, ie. PS/2 and serial mouse at the same time.

## Moving the Mouse Pointer

Make sure your computer supports the use of a mouse and that you attached the appropriate mouse cable to the back of your computer. See *Connecting the Equipment* if you have any questions. You can then use the mouse.

### Moving Slowly

Move the mouse pointer slowly around the screen by pressing the north, south, east and west keys with your *right index* finger.

### Moving Quickly

Move the mouse pointer quickly around the screen by pressing the north, south, east and west keys with your *left index* finger.

### Moving at High Speed

Move the mouse pointer at high speed around the screen by pressing the north, south, east and west keys with *both index* fingers at the same time.

### Moving Diagonally

You can move the mouse pointer diagonally by pressing two adjacent directional keys simultaneously. For example, move northwest by pressing the north and west keys together with one of your index fingers.

### Changing Mouse Speed Settings

See Program <J> in the table in the section *Changing DataHand® System Settings: The Program Selection Keys, pg.43*, for instructions on fine tuning mouse speeds using the DataHand® System.

Your existing software might have a facility to adjust the range of mouse speeds. For example, in Microsoft Windows®, the mouse control panel has a slide button for this purpose. However, if you find that the slide button does not give you the range of control you need, you may increase the sensitivity of that slide button by editing the MOUSE.INI file. You do so using a DOS editor. For help with this, contact DataHand® Systems, Inc. using the reference in the *Getting More Help* section.

### Clicking the Mouse Buttons

To click the left mouse button, press the **mb1** key (*left index finger, well key*).

To click the right mouse button, press the **mb2** key (*right index finger, well key*).

If your computer supports a 3-button mouse, you can click the equivalent of the middle mouse button by pressing the **mb3** key (*left ring finger, well key*). You must have first activated the middle mouse button. See Program <M> in the table in the section *Changing DataHand® System Settings: The Program Selection Keys, pg.44*, for instructions on activating the middle mouse button.

## Using the Arrow Keys to Move the Cursor

To use the arrow keys in Mouse Function mode, you must first turn on the arrow keys and turn off the mouse. To do this, enter Mouse Function mode and press the arrow key toggle  (*right middle finger, well key*). The yellow mouse light on the template for the left middle finger should go off. These keys are the *Grey Arrow Keys* on the standard keyboard. Note: The HOME key is only available in this condition and activated with the LT or RT Index Finger Down keys.

If you are in 10-Key pad configuration, you do not have to turn on the arrow keys; they are automatically activated on the left index finger.

### Moving the Cursor

Move the cursor around the screen by pressing the north, south, east and west keys with *either index finger*.

### Switching Back to the Finger Mouse

To change from arrow key function back to mouse function, first enter Mouse Function mode. Then press the mouse key  (left middle finger, well key). The orange mouse light on the template for the left middle finger should go on.

Note for IBM computers and compatibles only: Most applications do not distinguish between the directional arrow keys on the right and left hands, so either hand can move the cursor. However, if your application does make a distinction, then the left hand arrow keys will behave like the arrow keys on the extended keyboard of a flat keyboard (between the 10-Key pad and the main part of the keyboard). The right hand arrow keys will behave like the arrow keys on the 10-Key pad. If you are working with such an application, the arrow keys on only one index finger will work. To switch the set that is operating, see the section *Switching Left and Right Function for Duplicate Keys: The L/R Modf Key*. Page # 42.

### Mouse Click Lock

#### MOUSE Click Lock:

Hold the Function Mode direct access key up and press either the right or left mouse buttons. To release hit either right or left mouse button or any other key that is not a mouse movement key like ALT, SHIFT or CTL. Examples:

#### WINDOWS EXAMPLES:

**To block text:** Enables the click lock for Left Button. Move mouse to highlight the text.

**To delete text:** Press the delete key. The delete will release the mouse button and delete the text. Try this with CTL X for CUT or CTL C for COPY.

**To move text:** The user may also move the highlighted text by using click lock again. Now as you move the mouse the box of text is moved and can be dropped at a new location with by releasing as described above.

**Limitations:** The CTL key can not be used with the drag to duplicate an object selected because the button is released upon action from the CTL key. To copy, use the right mouse click-lock to move and duplicate the text, choose copy when the menu pops up.

## SECTION 8

# SPECIAL KEYS

This section describes keys that you might use under special circumstances or with special applications. It directs you through all the necessary steps when changing functions.

## Switching Left and Right Function for Duplicate Keys: The L/R Modf Key

A few software applications differentiate between keys that are apparently duplicated on the left and right sides of a standard flat keyboard and use the different scan codes sent by the keyboard for the right and left positions...each key position is unique and has its own scan codes assigned. Some applications may even require that you use the keys in one or the other of these locations, although most applications allow you to use the keys on either side, for the same purpose.

The default mode for the duplicated keys is to send the “left” key scan code. . When these keys are pressed, they send codes to the computer that then identifies them as the “left” key. To change the **L/R Modf**, hold up the FUNC Mode key and at same time press the **L/R Modf** (*left little finger, well key...light on the right hand will flash to verify entry into right side*). To change a key back to left function, repeat the procedure. Alternatively the ALT and CNTR keys can toggle to RT by double clicking either key.

When the computer is turned off and on again, the keys revert to the default “left” key mode. To permanently change the default, use program key <A>, as described in the table in *Changing DataHand® System Settings: The Program Selection Keys, pg. 44*.

Keys Affected by the L/R Modf Key	
Keys	Mode
<b>ALT, CNTRL, SHIFT, DELETE</b>	All modes <div style="border: 1px solid black; padding: 2px;">           Note: The extra <b>SHIFT</b> key (<i>right hand, middle finger, east</i>) in Mouse Function mode acts opposite to the <b>SHIFT</b> key under the right thumb, which is available in all modes.         </div>
<b>INS, PAGE UP, PAGE DN, END</b>	Mouse /Function mode
<b>+ * - /</b>	NAS mode
<b>/</b>	Normal mode
<b>WINDOWS</b>	Normal and Function modes.

Some keys differentiate between left and right function, but are not affected by the **L/R Modf**. They are:

- The **Home** keys
- **ENTER**
- keys in the 10-Key pad configuration



The DataHand® System has two **HOME keys** that are available in Mouse Function mode. The **HOME** keys are only in the ARROW condition (mouse light off) the down keys of the left and right index fingers and have left and right function, respectively. The **L/R Modf** key does not affect these keys. Some applications require the left only or the right only key. If you are using an application that requires you to use one or the other of these keys, only one of them will work.

The **RETURN** key (*left thumb*, northwest) has left function. The **ENTER** key (*right ring finger*, east) has 10-Key pad Enter. In the 101-keyboard mode, the L/R Modf affects neither key. Both keys are available in all modes.

In the 104-keyboard mode (WINDOWS), the **ENTER** key (RT Ring East—**WINDOWS** key) can be switched by the **L/R Modf** in the Normal and Function Modes.

As stated in the 10-Key Configuration section, if **NUM LOCK** is on, the numbers and operators available in 10-Key configuration send the same scan codes as the keys of the 10-Key pad on the right side of a flat keyboard. If **NUM LOCK** is off, the keys send the same scan codes as the keys in the main part of a flat keyboard. The **L/R Modf** key does not affect the keys available in 10-Key configuration.

## Changing DataHand® System Settings: Program Selection Keys

Special program keys allow you to change settings of the DataHand® System. The new settings will remain in place until you change them again or perform a full reset.

To make the setting changes, **engage these two keys:**

- first the direct access key for Normal mode (*left thumb*, up), then at the same time
- press and release the Reset button at the back of the left hand unit

Note: To prevent errors, release the Reset button first and then the Normal Direct Access key.

After you release these keys, the red 10-Key indicator light on the right hand unit flashes. It continues to flash until you enter one of the Program Selection keys indicated in the following table.

If the system change takes effect after you press the Program Selection key, the three mode lights on the right hand unit flash three times in acknowledgement. If the three mode lights continue to flash, you must take further action, as specified in the following table.

## SECTION 8 SPECIAL KEYS

Changing Default Settings	
Key	Effect and any further actions necessary
A	Toggles all special keys from left function to right or vice versa and save these new settings as the defaults. See <i>Switching Left and Right Function for Duplicate Keys: The L/R Modf Key</i> , pg. 42 for information about temporarily switching individual key functions.
ENTER (Rt. Ring East)	Toggles to Windows (104) Key Mode – <b>APPLICATION</b> Key on this key in <b>NAS and RT WINDOWS</b> key in <b>NORM</b> and <b>FUNC</b> Modes. <b>ENTER</b> in the <b>TEN KEY</b> Mode (no change). <b>L/R Modf</b> Toggles between LT/RT WINDOWS key.
G	Toggles Mouse “nudge” feature off/on. For more information see <b>Mouse Nudge</b> , pg. 45.
I	Toggle protection OFF/ON for FUNCTION keys.
J	Allows mouse speed adjustment. Choose one of the following options: R to increase left mouse speed V to decrease left mouse speed U to increase right mouse speed M to decrease right mouse speed H to decrease mouse acceleration ' to increase mouse acceleration J to exit mouse speed adjustment.
K	To toggle off or on the <i>Protection Mode for PRINT SCREEN, NUMLOCK, TEN KEY OFF, TEN KEY ON and L/R MODF</i> . For more information see Pg. 25.
M	Activates the middle button of a Logitech® 3-button mouse. If the middle button is already active, this action returns the mouse to 2-button format.
N	Swap the <b>CTL</b> and <b>ALT</b> keys.
O	Swap <b>FUNCTION</b> and <b>NORMAL</b> Direct Access keys.
P ;	Toggles to emulate the model DH200 with (5) Thumb Keys. After toggle P --- toggles to model DH200 using thumb down chording (up keys not needed).
S	A speed typist option to force the SHIFT break when typing shifted keys: e.g.,! @#\$%^&*().
Q	Changes from IBM PS2 to RS6000 keyboard emulation.
R	Displays “Rev x.xx MM 2 or 3” (for Microsoft) or Rev x.xx P (for PS/2 mouse) on the computer screen, where x.xx is the revision number of the DataHand® System you are using, and 2 or 3 is the number of mouse buttons that are enabled. L or R indicates left or right key modifier.
Z	Switches the Mouse Function and NAS access keys: <b>NAS SHIFT</b> ( <i>right thumb</i> , light pressure, down) becomes <b>Mouse Function Shift</b> . <b>NAS LOCK</b> ( <i>right thumb</i> , hard pressure, down) becomes <b>Mouse Function Lock</b> . The Mouse Function mode direct access key ( <i>right thumb</i> , up) becomes the NAS Lock direct access key. <div style="border: 1px solid black; padding: 5px; margin: 10px 0;">Note: When NAS Shift is lost, Mouse Function Shift is gained. The Mouse Function Shift might be more useful when you require a lot of cursor and mouse movement in another mode.</div> To switch the keys back to their original functions, repeat these steps.
Normal direct access and \ key (held together)	Resets all permanent memory to default values. In other words, the system reverts to all original settings, such as the original mouse speeds and the original settings for the NAS and Mouse Function access keys. All desired non-default program modes must be re-set.

## SPECIAL KEYS, FEATURES AND OPTIONS

### Windows Keys ... 104 Keyboard

The 104 keyboard is toggled with Program Mode <ENTER> (Rt. Middle Finger East). If the 104 keyboard is selected then the Right Ring Finger east becomes:

- APPLICATION Key in NAS;
- Right WINDOWS key in NORM and FUNC modes; and
- ENTER in Ten Key Mode.

The L/R Modf toggles between LT/RT WINDOWS key.

(See Changing Default Settings , page 44).

### Cursor Keys

Cursor keys are found in the FUNCTION Mode on either the Right or Left Index Finger when Mouse LED is OFF ... Rt. Middle Finger Down turns the Mouse LED off. The Ten Key Pad arrows are on the left-hand index finger.

### Mouse Nudge

The mouse has a “nudge” feature that allows fine movement by delaying full speed. A few computers may find the delay excessive. In this case the “nudge” feature may be cancelled using Program Mode “G” (See Changing Default Settings , page 44).

### Swap Alt and CTL Keys:

The position of these two keys can be changed. From Program Mode (see User Guide, page 44) set the SWAP CTL & ALT keys with option ‘N’.

### L/R ALT and CTL KEYS:

**L/R Modf** will switch the scan code output of the **ALT** and **CTL** keys. Alternatively a double strike of the either key will temporarily change to the alternate scan code output.

### SwapThumb ‘UP’ Keys:

From Program Mode (see User Guide, page 44) set the SWAP THUMB ‘up’ keys option ‘O’.

### Foot Pedal Support:

The Foot pedals become shifted accesses switches for FUNCTION and NORMAL Mode direct access key. Call DataHand Systems to add the foot pedal option.

### PS/2 Mouse Enable:

Any hand mouse if hot plugged (not recommended), will power up as enabled. The DEK PS/2 mouse also powers up as enabled if reconnected (not recommended).

### DH-200 MODEL COMPATIBILITY:

**This section for former DH200 users only.**

From Program Mode, set the DH-200 command option '**P**'. This new mode still allows the use of the direct access switches but creates the chorded NAS and FUNCTION Mode shifting that was used with the DH-200. The DH-200 keyboards came originally changed mode using a chorded key scheme. There was no up thumb key. To select this option, press ';' (semi colon) while in Program Mode. An additional addendum is available for former DH-200 users to explain the DH-200 compatibility.

### Macintosh Users:

The MAC's **COMMAND**, **CONTROL** and **POWER -ON** Keys can be programmed as follows:

#### MAC USB ADAPTER SETUP:

The DataHand must first be set up as a 104 key keyboard so the **WINDOWS** and **APPLICATION** Keys are available to the MAC Adapter. See Changing Default Settings , page 44.

- Hold Left Thumb up and at the same time press the Square RESET Button behind the left unit;
- Release the RESET Button first and the Left Thumb Up--- the Red LED on the right unit will be blinking;
- Press the Rt. ENTER key (Right Ring East) --- the Green NAS light will light.

With the MAC USB Adapter connected hold down **<ESC>** and at the same time press the **<W>** key. Now the MAC Adapter will send the following commands:

- Press and hold the **<ESC>** key and at the same time press the letter **<W>** key. Now the MAC Adapter sends:
- **<COMMAND>** Key when the RT **<ENTER>** Key is pressed in either NORMAL or FUNCTION Modes.
- **<OPTION>** is sent when the RT **<ALT>** key is pressed (L/R *Modf* key toggled) or Double Strike the **<ALT>** Key.
- POWER ON is sent with the **<SCROLL LOC>** key.

### ADB ADAPTER:

- If KINESIS P/N-AC016PM (W) --- keys operate as the USB set up above.
- If other adapter is used usually **<CTRL>** is the MAC's **<COMMAND>** and **<ALT>** is the MAC's **<OPTION>** Key.

## SECTION 9

# COMMON QUESTIONS

This section covers the most common questions that DataHand® System users ask, as well as the answers to these questions. If you have questions that cannot be answered by reading this manual, contact DataHand® Systems, Inc. customer service, using the reference in *Getting More Help* at the end of this section.

## Questions and Answers

**1. Q.** How do I activate the mouse?

**A.** First make sure that your computer supports the use of a mouse. You must also have attached the necessary mouse cable. See the *Getting Started* section if you have questions about connecting the mouse cable.

After you make the necessary cable connections, turn on your computer. When you enter Mouse Function mode, the orange mouse light on the template for the left middle finger should be on and the mouse should be activated. If not, in Mouse Function mode press the mouse key  (left middle finger, well key). The mouse light should go on. See the *Using the Finger Mouse and Arrow Keys*, page 37 for more details.

**2. Q.** The mouse driver is installed, the mouse cable is connected and I've turned on the mouse. Why doesn't the mouse work?

**A.** If you are using Microsoft Windows® on a PC, sometimes the default settings in Microsoft Windows® must be changed to reflect the correct mouse driver. To check that the default setting is correct, select [Windows Setup] [Options] [Change System Settings] [Mouse] and make sure the setting is "Microsoft IBM PS/2 or compatible." If the mouse still does not work, you might have to modify the AUTOEXEC.BAT file to reflect the correct driver designation.

If you have a PS/2 mouse driver, make sure you power down your system before connecting the parts of the DataHand System to get a functioning mouse.

You should also determine if you have a bus mouse. If you do, you must disable the mouse, either through the software or by removing the card. Contact DataHand® Systems, Inc. using the reference in *Getting More Help*, page 57, at the end of this section.

**3. Q.** How do I activate the arrow keys?

**A.** In 10-Key configuration, the arrow keys on the left hand index finger are automatically activated.

The only other mode in which you can use the arrow keys is Mouse Function mode. In this mode, make sure the orange mouse light on the template for the left middle finger is off. If it is on, press the arrow toggle key  $\updownarrow$  (*right middle finger, well key*). The mouse light should go off. See *Using the Finger Mouse and Arrow Keys*, page 37 for more information.

4. **Q.** Sometimes I get keys that I shouldn't (e.g., a <1> when I push the END key or <.> when I push the DEL key) or I don't get shifted keys when I should (e.g., <?>)?
- A.** The L/R *Modf* key is in the Right mode and should be toggled again to reset to the Left position. See *Switching Left and Right Function for Duplicate Keys*, page 42.
5. **Q.** Where is the 10-Key pad?
- A.** The numbers on the 10-Key pad, as well as the arithmetic operators, are available through NAS mode. See the *10-Key Pad* section, page 31 for details and an illustration.
6. **Q.** I used the 10-Key pad, but now I need NAS mode. How do I get out of the 10-Key pad and back to NAS mode?
- A.** If you enter NAS mode and the 10-Key pad is activated, you must while holding **NAS** key to 2<sup>nd</sup> position (all the down) press **10-Key OFF** (*right pinky, west*) to return to NAS mode. Otherwise, every time you enter NAS mode, you will access the 10-Key pad instead of the NAS mode characters.
7. **Q.** My computer is frozen. What can I do?
- A.** Check the connections on each of the cables to make sure that they are secure. Disconnect and then reconnect the hand unit cables.

If the computer is still frozen, press the Reset button on the rear of the left hand unit or press **CNTRL + ALT + DELETE** together to reboot the system (warm boot). The DataHand®



System should return you to Normal mode.

If this does not work, try a cold boot. Turn off the computer, disconnect and reconnect the cables again and turn the computer back on. If you have persistent problems, contact DataHand® Systems, Inc. using the reference in *Getting More Help* at the end of this section.

- 8. Q.** Why am I having trouble switching modes?
- A.** Check to see if any key caps are open or stuck. If so, there may dust or other foreign material holding the key open. To clean the switches, open the keys and blow out with canned air (found in any computer supply store).
- 11. Q.** How can I reset to the as shipped Default Settings??
- A.** Enter Program Mode <\>. See *Changing Default Settings*, page 44.
- 12. Q.** How can I display the version number of my DataHand® System?
- A.** You can display the version number of your DataHand® System by using the program key <R>. The number of active mouse buttons is also displayed. See *Changing Default Settings*, page 44.
- 13. Q.** Where do I find the serial number of my DataHand® System?
- A.** The serial number is on the underside of both hand units.
- 14. Q.** How do I get the Function Keys to work?
- A.** The Function Keys are “Protected Keys” and require holding the function Access Key (Rt Thumb Up) at the same time activating the desired Function Key. For more on *Protected Keys* see *Using Protected Mode Keys*, page 25.

15. **Q.** How can I use the APPLICATION and WINDOWS keys found on a 104 key keyboard?
- A.** The 104 key keyboard mode is awith Program Mode <ENTER>. See *Changing Default Settings* , page 44.
16. **Q.** I can only find one connector to connect the DataHand Ergonomic Keyboard and Mouse.
- A.** Some notebook computers such as the IBM Thinkpad, require a “Y-Connector” to connect an external keyboard such as the DataHand Ergonomic Keyboard to the common single dual port.
17. **Q.** What does the **Print Screen** key do?
- A.** When activating the **Print Screen** key, Windows loads a copy of the screen graphics to the clipboard. The clipboard contents then can be pasted to a graphics program such as Paint (found in [Start] [Programs] [Accessories]). If multiple Windows are open, **Ctl-Print Screen** will copy the open window contents only. In DOS the **Print Screen** key will print the screen text to the printer.

## SECTION 10

# **WINDOWS NOTES & SHORTCUT KEYS**

This section covers the shortcut keys useful with DataHand to speed up your Excel, Windows and Word usage by reducing mouse movement.

## Windows Notes & Shortcut Keys:

### Shortcut Keys using EXCEL with DataHand

CTL + ESC - Start menu  
ALT + TAB- Switch between tasks  
CTL + F4 - Close current file  
ALT + F5- Close Excel  
CTL + S- Save file

#### **Numeric Entry / Basic Entry Modes:**

Lock into FUNCTION mode (up):  
Shift to NAS to enter numbers.  
Cursor to next Cell for entry.

OR

Swap Function and NAS mode usage via program mode.  
Lock into NAS mode (up):  
Enter numbers  
Shift to Function (down) & use cursor to move from cell to cell.

#### **Movement to Cell:**

ARROW - To move one at a time or let repeat occur.  
CTRL + HOME - Move to 1<sup>st</sup> cell.  
CTRL + END - Move to last cell.  
CTRL + ARROW - Move to last active cell on Row or Column.  
F5 or CTRL + G - Move to Cell xx  
(may type cell # or TAB and cursor to prev cell location).  
ALT + PGDN - Move cursor right a full screen.  
ALT + PGUP - Move cursor left a full screen.  
PGUP - Move cursor up a full screen.  
PGDN - Move cursor down full screen.

#### **Mark Cells:**

SHIFT + ARROW- Mark the next cell.  
SHIFT + CTRL+END-Mark from cursor to END.  
SHIFT +CTRL+HOME-Mark from cursor to cell A1.  
SHIFT + CTRL + ARROW – Marks row or column.  
(has various affects depending on cursor location).  
CTRL + Z - Undo  
CTRL + C - Copy  
CTRL + X - Cut  
CTRL + V - Paste

**Miscellaneous:**

Shift F3 -	Open Function Wizard
Shift F4 -	Go to next empty cell in row
DBL Left Click -	Edit on cell
CTRL + F9 -	Minimize current open file
CTRL + F10 -	Toggle between small and large screen

Note: The main limitation using cursors is being unable to edit at the cell location without deleting the cell data, unless you double click mouse on cell, or click on edit window, or use f2.

## Shortcut Keys using Windows with DataHand

CTL + ESC -	Start Menu
ALT + TAB -	Switch between tasks
ALT SPACE N -	Minimize application screen (do not need to chord)
SNGL RT CLICK TOP BAR + N -	Minimize application screen
DBL LT CLICK TOP BAR -	Toggle between full screen and small screen

**Program Tools:**

ALT + F4 -	Close current program window
CTL + F4 -	Close current file
CTL + O -	Open selection in file
CTRL + Z -	Undo last

**Selecting Files:**

CTRL + A -	Selects all items
SHIFT + ARROW -	Include all items to the cursor as selected
SPACE -	Select item at cursor
CTRL + ARROW -	Move cursor without changing selection
CTRL + SPACE -	Add item at cursor to selection
F2 -	Rename selected object
F5 -	Refreshes current window

**Button Selection:**

ENTER -	Equivalent to clicking the Select button
ESC -	Equivalent to clicking the Cancel button

**Miscellaneous:**

CTRL DRAG - Copy object to new location (problem with using CTRL)  
SHIFT + F10 - Application key / sometimes right mouse click  
PRNTSCRN - Copies screen image to clipboard  
ALT + PRNTSCRN - Copies image of active window to clipboard

## **Shortcut Keys using WORD with DataHand**

CTRL B - Toggle BOLD on/off  
CTRL U - Toggle UNDERLINE on/off  
SHIFT + ARROW - Mark characters during cursor movement  
SHIFT+CTRL+ARROW- Mark words during cursor movement  
SHIFT + END - Mark from cursor to end of line  
DELETE - Deletes marked text  
HOME - Moves cursor to beginning of line  
END - Moves cursor to end of line  
CTRL + ARROW - Moves cursor a word at a time  
CTRL + HOME - Moves cursor to top of document  
CTRL + END - Moves cursor to end of document  
CTRL + Z - Undo last  
CTRL + C - Copy to clipboard  
CTRL + X - Cuts to clipboard  
CTRL + V - Paste from clipboard

## GETTING MORE HELP

DataHand® System's customer service can be reached at **(800) 875-7171** or **(602) 233-6000**. Please be prepared to give the customer service support representative the serial number and the version number of your DataHand® System, the type of computer, and operating system you have.

You can also mail, fax or email your questions to:

DataHand® Systems, Inc.  
3032 N. 33rd Ave.  
Phoenix, AZ 85017-5201  
Attn: Customer Service Support

Fax: (602) 233-3434

E-Mail: [techsupport@datahand.com](mailto:techsupport@datahand.com)

Website: <http://www.datahand.com>