

IBM ThinkPad 365X/365XD

S76H-7579-00

User's Guide

IBM

IBM ThinkPad 365X/365XD

S76H-7579-00

User's Guide

Note

Before using this information and the product it supports, be sure to read the general information in Appendix E, Product Warranties and Notices. You should also read the safety guidelines on page xii.

First Edition, April 1996

The following paragraph does not apply to the United Kingdom or any country where such provisions are inconsistent with local law: INTERNATIONAL BUSINESS MACHINES CORPORATION PROVIDES THIS PUBLICATION "AS IS" WITHOUT ANY WARRANTY OF ANY KIND, EITHER EXPRESS OR IMPLIED, INCLUDING, BUT NOT LIMITED TO, THE LIMITED WARRANTIES OF MERCHANTABILITY OR FITNESS FOR A PARTICULAR PURPOSE. Some states do not allow disclaimer, or express or implied warranties in certain transactions; therefore, this statement may not apply to you.

This publication could include technical inaccuracies or typographical errors. Changes are periodically made to the information herein; these changes will be incorporated in new editions of the publication. IBM may make improvements or changes in the products or the programs described in this publication at any time.

It is possible that this publication may contain reference to, or information about, IBM products (machines and programs), programming, or services that are not announced in your country. Such references or information must not be construed to mean that IBM intends to announce such IBM products, programming, or services in your country.

Requests for technical information about IBM products should be made to your IBM Authorized Dealer or your IBM Marketing Representative.

IBM may have patents or pending patent applications covering the subject matter in this document. The furnishing of this document does not give you any license to these patents. You can send license inquiries, in writing, to the IBM Director of Licensing, IBM Corporation, 500 Columbus Avenue, Thornwood, NY 10594, USA.

Copyright International Business Machines Corporation 1996. All rights reserved.

Note to U.S. Government Users – Documentation related to restricted rights – Use, duplication or disclosure is subject to restrictions set forth in GSA ADP Schedule Contract with IBM Corp.

Thank You for Selecting an IBM ThinkPad 365X or 365XD Computer

The IBM ThinkPad 365X/365XD computer is one of the most advanced notebook computers available today.

You will find many uses for its powerful features: fast processing power, a built-in quad-speed CD-ROM, a brilliant, colorful DSTN or TFT LCD display, audio capabilities, and infrared communication.



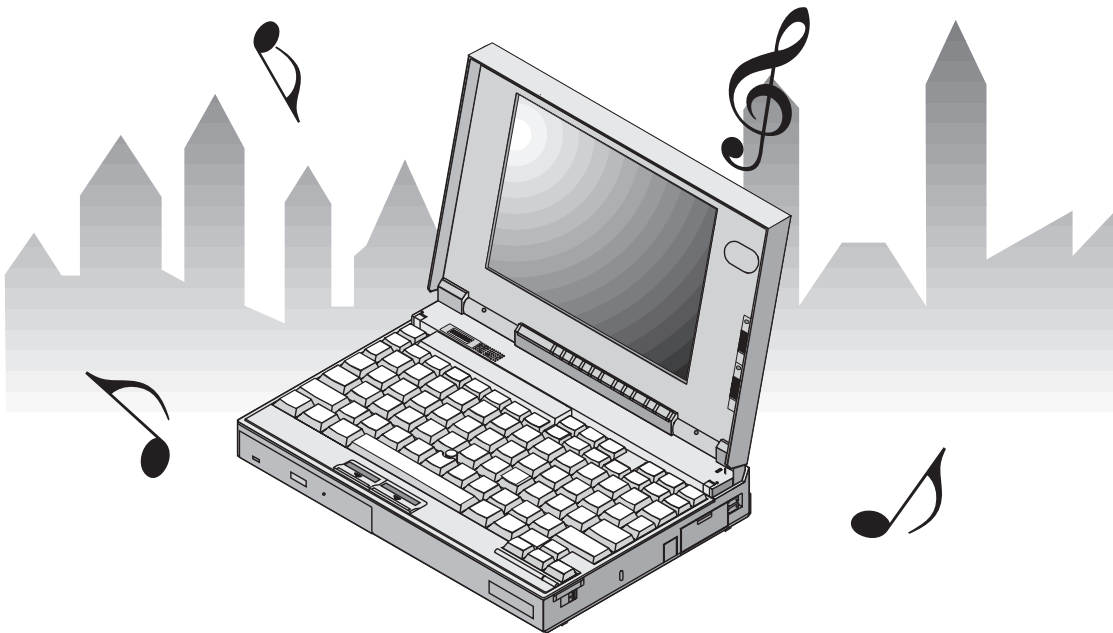



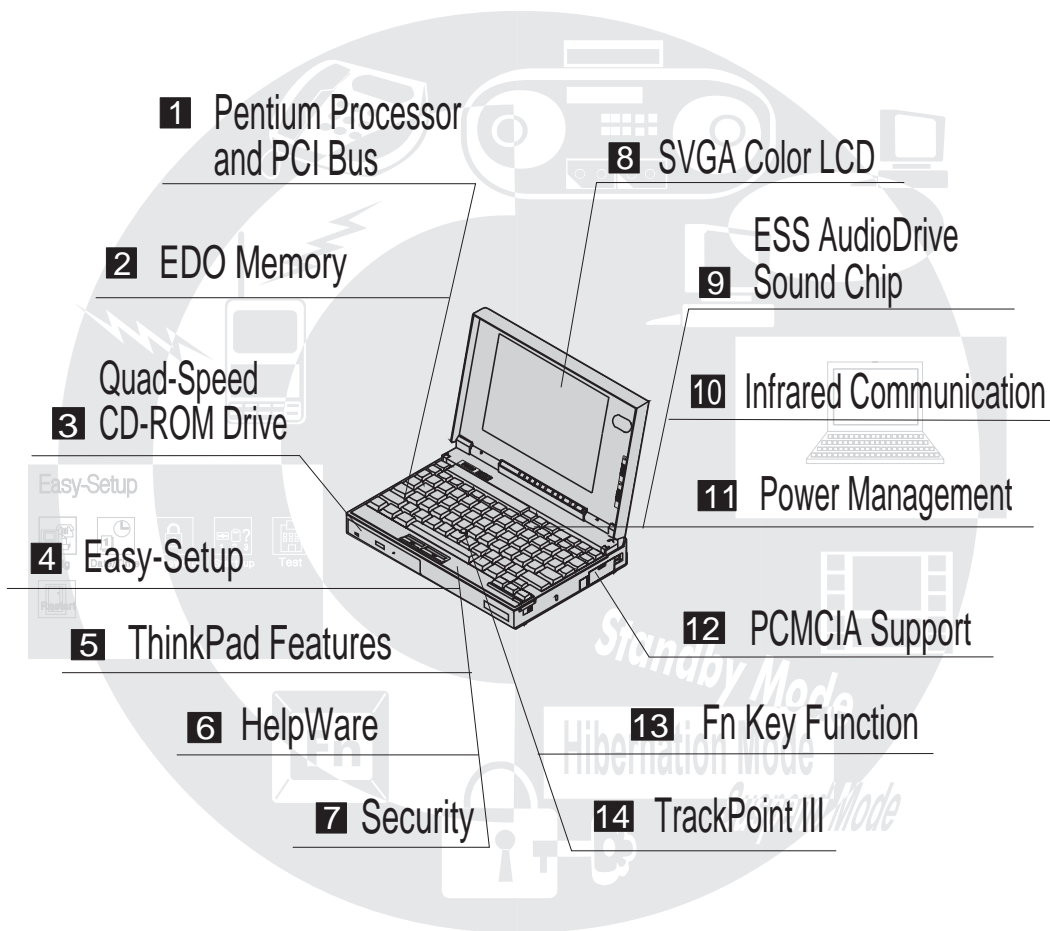



We are happy to offer the IBM ThinkPad 365X/365XD to help meet all your mobile computing needs.



Here are the distinctive system features of your IBM ThinkPad 365X/365XD computer:



- 1 **Pentium Processor and PCI Bus.**
The fast Intel** Pentium** processor and PCI bus combine to give your computer optimal speed and performance.
- 2 **EDO Memory.**
The built-in extended data out (EDO) memory chip enhances performance with fast memory access.
- 3 **4X CD-ROM Drive:**  Page 58.
The built-in quad-speed CD-ROM model affords access to large databases and multimedia applications. It can even play your favorite music CDs.

- 4 **Easy-Setup:**  Page 37.
The built-in system programs in Easy-Setup let you set the basic configuration of your computer.
- 5 **ThinkPad Features Program:**  Page 33.
The ThinkPad Features program allows you to set various parameters by using a graphical user interface or commands.
- 6 **HelpWare:**  Page 216.
Comprehensive service and support packages for your IBM ThinkPad 365X/365XD computer are available in most countries.
- 7 **Security Features:**  Page 39.
The computer provides security passwords for the computer. Locking capability is provided for internal devices. Personalization is also provided to make it easy to identify your computer.
- 8 **SVGA Color LCD**  Page 48.
The DSTN (dual-scan super-twisted nematic) display models offer 256 colors at 800-by-600 SVGA resolution.
The thin-film transistor (TFT) display models offer 65,536 colors at 800-by-600 resolution.
- 9 **Audio Features:**  Page 56.
The system-integrated ESS** AudioDrive** Sound Chip provides stereo business audio (8 bit to 16 bit) with Sound Blaster** Pro compatibility.
- 1 **Infrared Communication:**  Page 54.
Wireless serial communication with one infrared port is supplied with your computer.
- 11 **Power Management:**  Page 70.
Power Management sets the computer to different modes to save battery power when you are not using the full power of your computer. It also provides a resume function, which quickly returns you to where you left off.
- 12 **PCMCIA** Support:**  Page 49.
The computer provides two Personal Computer Memory Card International Association (PCMCIA) slots. PCMCIA software also is provided so that you can use PC Cards more easily and conveniently.
- 13 **Fn Key Functions:**  Page 26.
The combination of this Fn key with a function key is used to control display modes and battery power-saving modes.
- 14 **TrackPoint III:**  Page 23.
Pointing, selecting, and dragging all become part of a single process with no need to lift your hands from the keyboard with the TrackPoint III.

About This Book

This book contains information that will help you operate the IBM ThinkPad 365X/365XD computer.

Chapter 1, “Getting Started,” provides information about unpacking your IBM ThinkPad 365X/365XD and describes how to set up your computer.

Chapter 2, “Getting Familiar with Your Computer,” acquaints you with the features of your computer.

Chapter 3, “Operating Your Computer,” provides information on using your computer with its different features.

Chapter 4, “Using Battery Power,” provides battery information and describes how to operate your computer with the battery pack.

Chapter 5, “Protecting Your Computer,” provides information for protecting your computer and internal devices against unauthorized use.

Chapter 6, “Installing and Removing Options,” describes how to install or remove IBM options. For optional memory module (DIMM) installation instructions, see page 119.

Chapter 7, “Installing Software,” provides procedures for installing operating systems and device drivers in your computer.

Chapter 8, “Solving Computer Problems,” describes what to do when you have a computer problem.

Appendix A, “Avoiding Hardware Conflicts,” describes what to do to avoid device address setting problems.

Appendix B, “Advanced Information for PC Cards,” provides additional information when using PC Cards.

Appendix C, “Using PS2 Commands,” describes PS/2 commands that you can use to alter computer settings.

Appendix D, “Features and Specifications,” describes the features and specifications associated with your computer.

Appendix E, “Product Warranties and Notices,” contains the warranty statements for your computer and notices for this book.

See the **Glossary** for the meaning of terms and acronyms used in this book.

An **Index** is also included.

Viewing the Online Book

Note:
The online book is not available in all countries.

You can view this book online to retrieve information about the computer. The *online book* provides an easy way to get needed information when you are traveling.

To start the online book, click on the **Online Book** icon in OS/2 Warp, Microsoft Windows Version 3.11, or Microsoft Windows 95.

Information Notices

This book contains notices that relate to specific information or text.

Note

Provides important hints, tips, guidance, or advice.

Attention

Indicates possible damage to programs, devices, system, or data. It appears next to the related instruction or situation in which possible damage could occur.

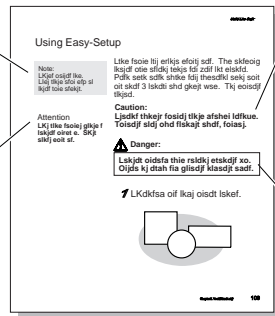

Caution

Indicates situations that are potentially hazardous to you. It appears in text before the instruction or situation that could be hazardous.

Danger

Indicates situations that are potentially lethal or extremely hazardous to you. It is indicated

by the symbol  and appears in text before the instruction or situation that could be dangerous.

Treatment of Icons

This book contains the following icons (symbols):

For procedures or information unique to the operating system installed in your computer:



Information for IBM Operating System/2 (OS/2) users.



Information for IBM DOS users.



Information for Microsoft Windows Version 3.11 users.



Information for Microsoft Windows 95 users.

For procedures or information unique to your computer model or type:



Information only for 365X models.



Information only for 365XD models.

For information referred to:



Where to go for more information.

Ergonomics Information

Notebook computers have made the **virtual office** a reality. The fact that you can use your ThinkPad virtually anywhere is a big plus in today's business world. Read this important information before using your ThinkPad computer in the virtual office.

Working in the virtual office may mean adapting to frequent changes in your environment. Following some simple “rules of the road” will make things easier and bring you the maximum benefits of your ThinkPad computer. Keeping in mind such basics as good lighting and proper seating, for example, can go a long way in helping you enhance your performance and achieve greater comfort wherever you are.

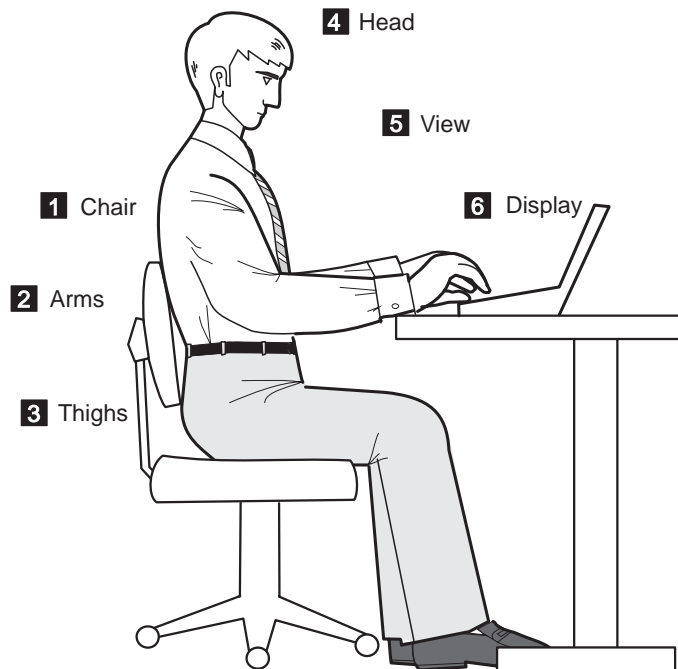

Note: *The example shown here is of someone in a traditional office setting. Even when not in such a setting, you can follow many of these tips. Develop good habits and they will serve you well.*

- 1 **Chair**
Use a chair that gives you good back support.
- 2 **Arms**
Keep your forearms, wrists, and hands in a relaxed and neutral position. Don't pound the keys; type with a soft touch.
- 3 **Thighs**
Keep your thighs parallel to the floor and your feet flat on the floor or on a footrest.
- 4 **Head**
Keep your head in a comfortable and vertical position.
- 5 **View**
Maintain a comfortable viewing distance of 20–30 inches.
- 6 **Display**
Position the display to avoid glare or reflections from overhead lighting or outside sources of light.

Keep the display screen clean and set the contrast and brightness to levels that allow you to see the screen clearly.

What if I am traveling?

It may not be possible to observe the best ergonomic practices when you are using the ThinkPad computer while on the move or in a “casual” setting, such as the seashore or on a mountaintop. Sometimes, your lap may be the only “desk” around. Regardless of the setting, try to observe as many of the tips for proper usage as possible. Sitting properly and using adequate lighting, for example, will help you maintain desirable comfort and performance levels.

Questions about vision?

IBM's visual display screens are designed to meet the highest standards and to provide you with clear, crisp images and large, bright displays that are easy to see, yet easy on the eyes. Of course, any concentrated and sustained visual activity can be tiring. If you have questions on eye fatigue or visual discomfort, consult a vision care specialist for advice.

Safety Notice



Do not disassemble, incinerate, or short-circuit the rechargeable battery pack. Do not put it in trash that is disposed of in landfills. Dispose of it as required by local ordinances or regulations. In the United States, call IBM at 1-800-IBM-4333 for information on disposal.

CAUTION:

The nickel metal hydride rechargeable battery can only be replaced by your dealer or an IBM service representative. Do not disassemble, incinerate, or short-circuit it. The battery can cause burns or release toxic chemicals. Do not put it in trash that is disposed of in landfills. Dispose of it as required by local ordinances and regulations.

CAUTION:

The fluorescent lamp in the liquid crystal display (LCD) contains mercury. Do not put it in trash that is disposed of in landfills. Dispose of it as required by local ordinances or regulations.

The LCD is made of glass, and rough handling or dropping the computer can cause the LCD to break. If the LCD breaks and the internal fluid gets into your eyes or on your hands, immediately wash the affected areas with water for at least 15 minutes; then get medical care if any symptoms are present after washing.

Laser Compliance Statement

The CD-ROM drive in the 365XD models of the IBM ThinkPad 365X/365XD is a laser product. The CD-ROM drive's classification label (shown below) is located on the top of the drive.

CLASS 1 LASER PRODUCT
LASER KLASSE 1
LUOKAN 1 LASERLAITE
APPAREIL A LASER DE CLASSE 1
KLASS 1 LASER APPARAT

The CD-ROM drive is certified in the U.S. to conform to the requirements of the Department of Health and Human Services 21 Code of Federal Regulations (DHHS 21 CFR) Subchapter J for Class I laser products.

In other countries, the drive is certified to conform to the requirements of EN60825.



Caution:

Do not open the drive; no user adjustments or serviceable parts are inside.

Use of controls, adjustments or the performance of procedures other than those specified may result in hazardous radiation exposure.

Class I (1) laser products are not considered to be hazardous. The CD-ROM drive has an internal, Class I (1), 0.5-milliwatt, aluminum gallium-arsenide laser that operates at a wavelength of 760 to 810 nanometers. The design of the laser system and the CD-ROM drive ensures that there is no exposure to laser radiation above a Class I (1) level during normal operation, user maintenance, or servicing conditions.

Contents

About This Book	vii
Viewing the Online Book	viii
Information Notices	viii
Treatment of Icons	ix
Ergonomics Information	x
Safety Notice	xii
Laser Compliance Statement	xiii
Chapter 1. Getting Started	1
Overall Setup Procedures	2
Checking Your Items	4
Setting Up Your Computer	6
Chapter 2. Getting Familiar with Your Computer	13
Locations	14
System Status Indicators	19
Providing Power	21
Operating with the TrackPoint III	23
Cleaning the Cap	25
Using the Fn Key Function	26
Operating the Numeric Keypad	28
Keeping the Computer from Being Damaged	29
Carrying the Computer	30
Chapter 3. Operating Your Computer	31
What Happens When Power Is Turned On?	32
Using the ThinkPad Features Program	33
Starting the ThinkPad Features Program	34
Using Easy-Setup	37
Starting Easy-Setup	37
Using the Selectable Drive-Startup Sequence	41
Using the Computer LCD or the External Monitor	43
Display Output Type	43
Points to Consider When Using the DOS Screen on the LCD	44
Attaching a Monitor	45
Using SVGA Video Mode	48
Using PC Cards	49
PC Card Limitations under Suspend Mode	49
Using the PC Card Director Program	50
Starting PC Card Director for OS/2 or Windows	51
Starting PC Card Director for DOS	53
Using the Infrared Communication Feature	54
Points to Consider for Infrared Communication	54
Audio Features	56
Using the External Diskette Drive	57
Using the CD-ROM Drive	58

Handling Compact Discs	59
Chapter 4. Using Battery Power	61
Charging the Battery Pack	62
Charging with the AC Adapter	62
Battery Pack Maintenance	64
Replacing the Battery Pack	65
Monitoring the Battery-Power Status	67
Using the Battery-Power Status Indicator	67
Using the Fuel-Gauge Program	68
Preserving Battery-Pack Life	70
Maximizing Battery-Powered Operation	70
Using Advanced Power Management	70
Decreasing LCD Brightness	73
Using the Battery Power-Management Function	73
Chapter 5. Protecting Your Computer	83
Using Passwords	84
Power-On Password	84
Hard Disk Password	89
Supervisor Password	94
Using the Personalization Feature	98
Entering the Personal Information	99
Deleting a Personalized Screen	101
Using Locks	102
Using Locking Devices	102
Affixing a Nameplate	103
Chapter 6. Installing and Removing Options	105
Upgrading the Hard Disk Drive	106
Upgrading a ThinkPad 365XD with an Internal CD-ROM Drive	106
Upgrading a ThinkPad 365X with an Internal Diskette Drive	111
Installing PC Cards	115
Removing PC Cards	118
Increasing Memory Capacity	119
Installing a DIMM	119
Removing a DIMM	123
Attaching an External Numeric Keypad or a Mouse	125
Using the Mouse and Other Pointing Devices	126
Attaching an External Keyboard	127
Attaching a Printer	128
IBM ThinkPad 365 Port Replicator	129
Installing the Port Replicator (Option A)	130
Charging the Battery Pack	131
Removing the Port Replicator	132

Installing the Port Replicator (Option B)	133
Inserting or Changing a CD or Floppy Diskette	135
Removing the ThinkPad	136
Chapter 7. Installing Software	137
What You Need for Your Computer	138
Installing the Operating System and Device Drivers	139
Installing Software for OS/2 Warp	140
Installing IBM OS/2 Warp Version 3	141
Installing the CD-ROM Device Driver for OS/2 Warp (for the 365XD Only)	147
Installing the ThinkPad Features Program for OS/2 Warp	149
Installing the PCI-IDE Bus Master Driver for OS/2 Warp	150
Installing the PC Card Director for OS/2 Warp	151
Installing the ESS AudioDrive Support Software for OS/2 Warp	152
Installing the Infrared Device Driver for OS/2 Warp	153
Installing the ThinkPad Display Device Driver for OS/2 Warp	155
Installing Software for DOS	156
Installing IBM PC DOS Version 7.0	157
Installing the CD-ROM Device Driver for DOS (for the 365XD Only)	158
Installing the ThinkPad Features Program for DOS	161
Installing the PC Card Director for DOS	162
Installing Software for Microsoft Windows 3.11	163
Installing Windows 3.11	165
Installing the ThinkPad Features Program for Windows 3.11	169
Installing the PC Card Director for Windows 3.11	170
Installing the AudioDrive Support Software for Windows 3.11	171
Installing the Infrared Device Driver for Windows 3.11	172
Installing the ThinkPad Display Driver for Windows 3.11	173
Installing Software for Microsoft Windows 95	174
Installing Windows 95	175
Installing the ThinkPad Display Driver for Windows 95	177
Installing the ThinkPad Features Program for Windows 95	178
Installing the PCI-IDE Bus Master Driver for Windows 95	179
Installing the PC Card Director for Windows 95	180
Installing the AudioDrive Support Software for Windows 95	184
Installing the Infrared Device Driver for Windows 95	186
Points to Consider When Using Windows 95	187
Chapter 8. Solving Computer Problems	189
Common Problems and Frequently Asked Questions	190
Common Problems and Actions	190
Frequently Asked Questions and Answers	192
Testing the Computer	193

Troubleshooting Charts	195
Error Codes	195
LCD Blank or Power-On Problems	198
Screen Messages	200
Other General Problems	201
What If Testing Cannot Find the Problem?	203
Battery Power Problems	203
CD-ROM Drive Problems	204
Diskette Drive Problems	205
Port Replicator Problems	205
External Monitor Problems	206
Hibernation Problems	207
Infrared Communication Problems	207
Keyboard, External Numeric Keypad, and Pointing Device Problems	208
Option Problems	209
PC Card Problems	210
Printer Problems	211
Software Problems	212
Getting Service	213
Listing Installed Options	213
Recording Identification Numbers	214
Getting Help, Service, and Information	215
Using the HelpWare Support Family	216
Purchasing Additional HelpWare Services	220
Custom Services	222
Obtaining IBM Operating System Updates	223
About Your Warranty	223
Service outside North America	224
Appendix A. Avoiding Hardware Conflicts	231
Avoiding System Resource Conflicts	231
Avoiding Conflicts When Using PC Cards	232
List of System Resources	236
Appendix B. Advanced Information for PC Cards	239
Auto Configurator for PC Card Director	239
Starting the Auto Configurator Utility for OS/2 or Windows	239
Adding to the CONFIG.SYS File	243
Registered Drivers and Standard Rules for OS/2	243
Registered Drivers and Standard Rules for DOS and Windows	246
Storage Card Device Driver	248
PCMCIA Storage Card Device Driver for OS/2	248
PCMCIA Storage Card Device Driver for DOS and Windows	248
Before Using PCMCIA Storage Cards	248

Using PCMCIA ATA Cards with Multiple Partitions	249
Parameters for the OS/2 PCMCIA ATA Card Device Driver	249
Parameters for DOS PCMCIA Storage Card Device Drivers	250
PCMCIA Storage Card Device Manager for OS/2	251
OS/2 PCMCIA Storage API Device Driver	252
Flash Card Memory Technology Driver	252
Checking the Allocated Resources for the PC Card	253
Avoiding PC Card Resource Conflicts	255
Virtual Card Services for OS/2	256
Appendix C. Using PS2 Commands	257
Appendix D. Features and Specifications	263
Specifications	265
Diskette Standards	266
IBM Power Cords	267
Appendix E. Product Warranties and Notices	269
Notices	272
Trademarks	272
Electronic Emission Notices	273
Glossary	275
Index	279

Chapter 1. Getting Started

Welcome to the world of ThinkPad computers!

The IBM ThinkPad 365X/365XD computer is designed to meet many multimedia and mobile computing needs. Its various features, unique to IBM products, can help your everyday work go easily and smoothly. You can use your IBM ThinkPad 365X/365XD computer in the office or at home as a desktop computer by attaching an external keyboard, display, or other external devices. And, of course, your computer can be easily carried wherever you need a computer “on the go.”

This chapter provides step-by-step instructions to help you set up your new computer.

Overall Setup Procedures	2
Checking Your Items	4
Setting Up Your Computer	6

Getting Started

Overall Setup Procedures

Before using the computer for the first time, review these overall setup procedures:

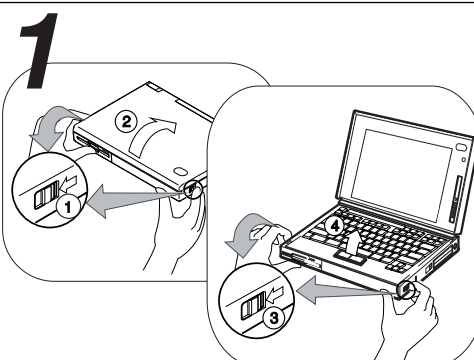
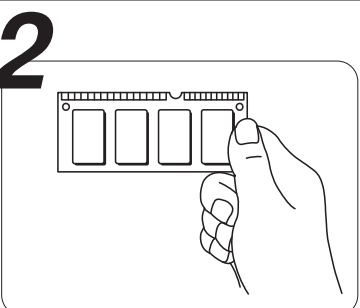
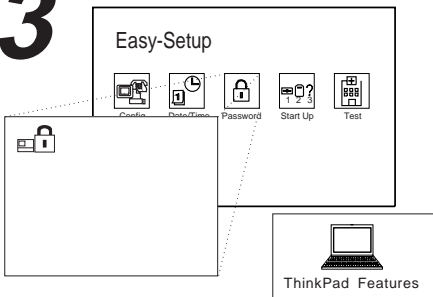
	<p>1 Set Up the Computer</p> <p>First, check whether you have all the necessary items with your computer.</p> <p>See page 4.</p> <p>Then, install the battery pack in the computer. Now you are ready to turn on the computer.</p> <p>See page 6.</p>
	<p>2 Install Options</p> <p>If you have any options, such as memory cards, install them now.</p> <p>See page 105.</p>
	<p>3 Customize Your Computer</p> <p>You can use <i>Easy-Setup</i>, a built-in system function, to set passwords to prevent your computer from unauthorized use, or use the <i>ThinkPad Features</i> program to customize your computer.</p> <p>For Easy-Setup, see page 37.</p> <p>For the ThinkPad Features program, see page 33.</p>

4

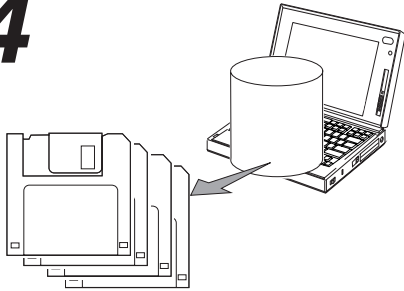

Make a Backup of Your System

Some computers come with the necessary software already installed for you to use the computer right out of the box. Or, you may have installed the operating system and software yourself. Whichever is the case for you, remember to make *a backup copy of your hard disk drive software*.

On some computers, the *Diskette Factory program* is installed so you can create backup diskettes. On other computers, you will find utility and device driver diskettes packed in the box with the computer.

If your computer did not come with the utility and device driver diskettes, make a backup copy of all necessary files using the Diskette Factory program. This way, if you ever need to reinstall the operating system, you will have all the necessary software you need to restore your computer to the way it was at the time of purchase.

Do you need more hard disk space?

If your computer did not come with the utility and device driver diskettes, and *you have already made a backup copy of all necessary software using the Diskette Factory program*, you can delete any preinstalled software you do not want to use to have more free hard disk space.

Click on the **Diskette Factory** icon; then follow the instructions on the screen.

You can also delete the demonstration program.

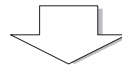
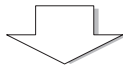

You are ready to use your computer.

If you have any application programs to install, follow the instructions in the documentation that came with those programs.

If you are reinstalling the operating system...

If you are reinstalling the operating system to customize your computer, follow the instructions in Chapter 7, "Installing Software" on page 137.



If you have any problems after you have customized your computer, refer to Chapter 8, "Solving Computer Problems" on page 189 for troubleshooting help.

Getting Started

Checking Your Items

Remove everything from the shipping box and check that all necessary items were shipped with your computer.

- 1 Match the items, one by one, with the following figures.
If any item is missing or damaged, contact your place of purchase.

 **Computer**

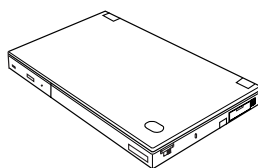

 **Battery Pack**

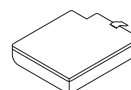

 **Power Cord**

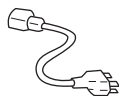

 **AC Adapter**

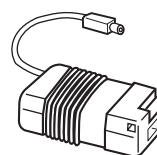

Getting Started

Diskette Drive

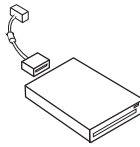

365X The *internal diskette drive* is installed in the computer.

365XD To use the *external diskette drive* and the CD-ROM drive at the same time, use the external diskette drive connector to connect the external diskette drive. You can also use the IBM Port Replicator to attach an external diskette drive.

Miscellaneous Items Envelope

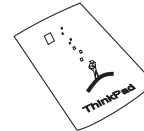

This envelope contains:

- Spare caps for TrackPoint III
- Other items

Utility Diskettes

Driver Diskettes

These diskettes contain various system programs and device drivers.

Note: In some countries, backup diskettes should be created using the Diskette Factory program when the computer power is turned on for the first time.

2 Turn the computer upside down and record the identification numbers **1** on page 214.

The machine type has a prefix of **Type**.
The serial number has a prefix of **S/N**.

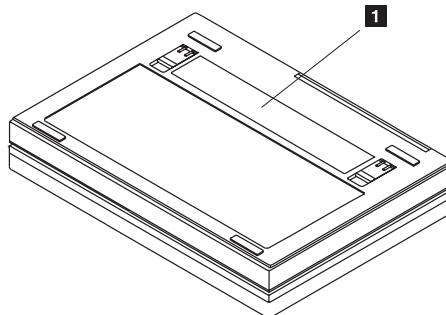

Setting Up Your Computer

You are now ready to assemble and start your computer. The steps on the next few pages guide you through the process. The following conventions are used in the steps and illustrations that appear in this book.

- 1** Indicates a main sequence of actions. This refers to the same number in the figure.
- ① Indicates a sequence of actions within a main action. An arrow accompanying a circled number shows the direction of movement.

Note

Battery packs shipped from the factory are in an almost-discharged state, so ***you must charge them fully before use.***

To install the battery pack:

- 1** Slide the latches on the sides of the computer ***halfway*** toward the front, and open the liquid crystal display (LCD).
(Do ① and ②.)
- 2** Slide the same two latches forward again all the way toward the front; then raise the keyboard.
(Do ① and ②.)
Some pressure might be needed to slide these latches if they are tight.

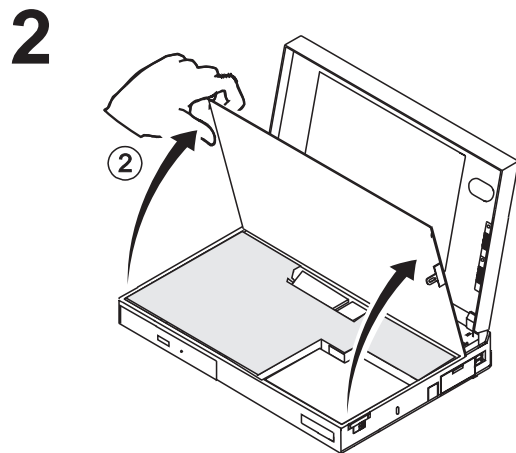
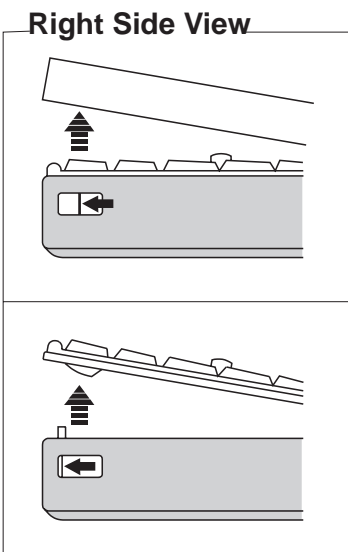
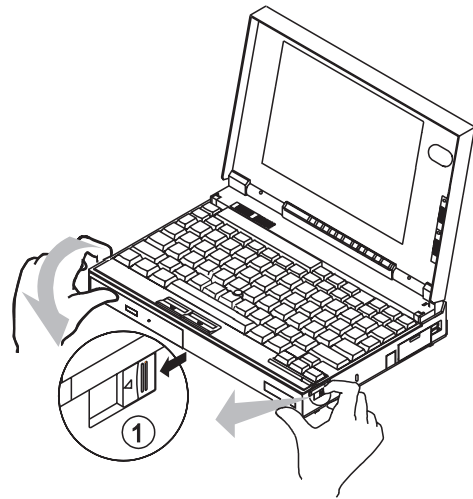
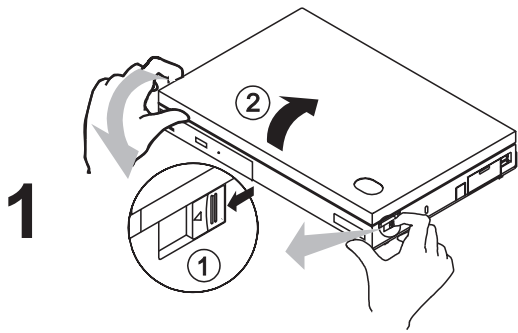

3



DANGER

The battery pack provided with your computer contains a small amount of harmful substances. To avoid possible injury:

- Keep the battery pack away from fire.
- Do not expose the battery pack to water or rain.
- Do not attempt to disassemble the battery pack.
- Avoid mechanical shocks to the battery.
- Always use battery packs recommended by IBM.
- Keep the battery pack away from children.

When disposing of the battery, comply with local ordinances or regulations or your company's safety standards.

Install the battery pack with the strap-side up and press it firmly into the connector.

(Do ① and ②.)

4 Close the keyboard by sliding the latches to the front and lowering the keyboard into place.

(Do ① and ②.)

3

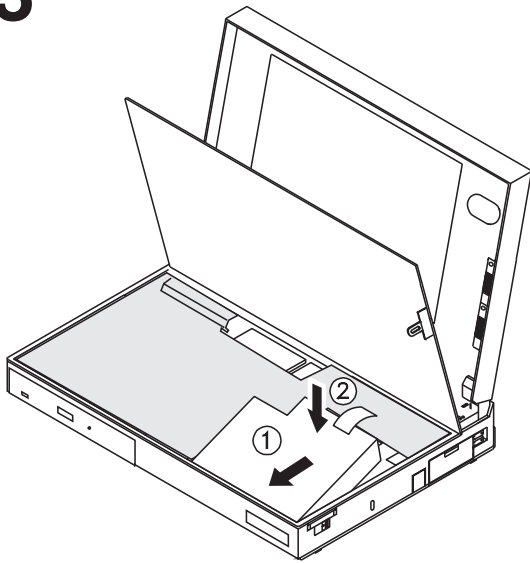

4

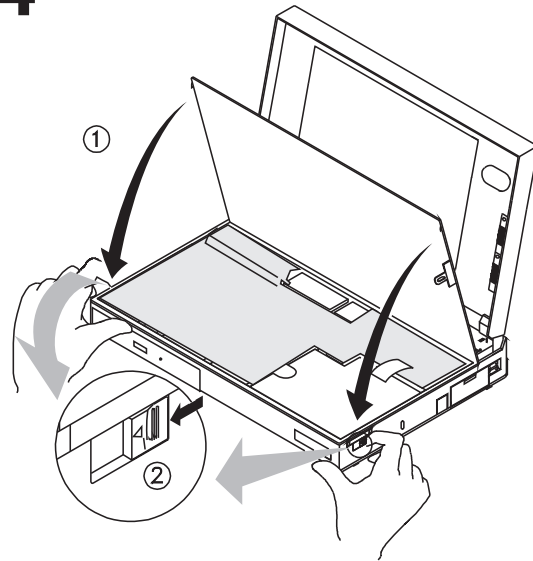

Getting Started

- 5** Slide the brightness control (☼)(①) to its upper position as shown; then set the speaker volume control to mid-position(②). (If your ThinkPad 365 model has a contrast control, adjust this control (●) ③ as well.)
(Do ①, ②, and, if appropriate, ③.)
- 6** Connect the AC Adapter as shown.
(Do ①, ②, and ③.)
- 7** Push and release the power switch to turn on the computer.
The power switch automatically returns to its original position after you push and release it.
- 8** After a single beep, one of the following screens appears, confirming that the system is operating correctly.

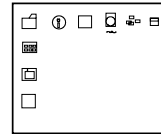
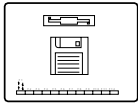

Diskette and F1 prompts.

This screen appears when no operating system is installed.

See page 137 to install all software necessary for your computer.

Date and Time menu.

This screen instructs you to set the date and time.

See page 38 to set the date and time.

Operating System Screen.

This screen appears when you have purchased a computer with an operating system installed.

(The screen shown is an example of an operating system screen. The actual screen may differ according to your operating system.)

On some computers, a demonstration program might start running.

If any other screen appears, a problem might have occurred in the computer. See Chapter 8, "Solving Computer Problems" on page 189.

Getting Started

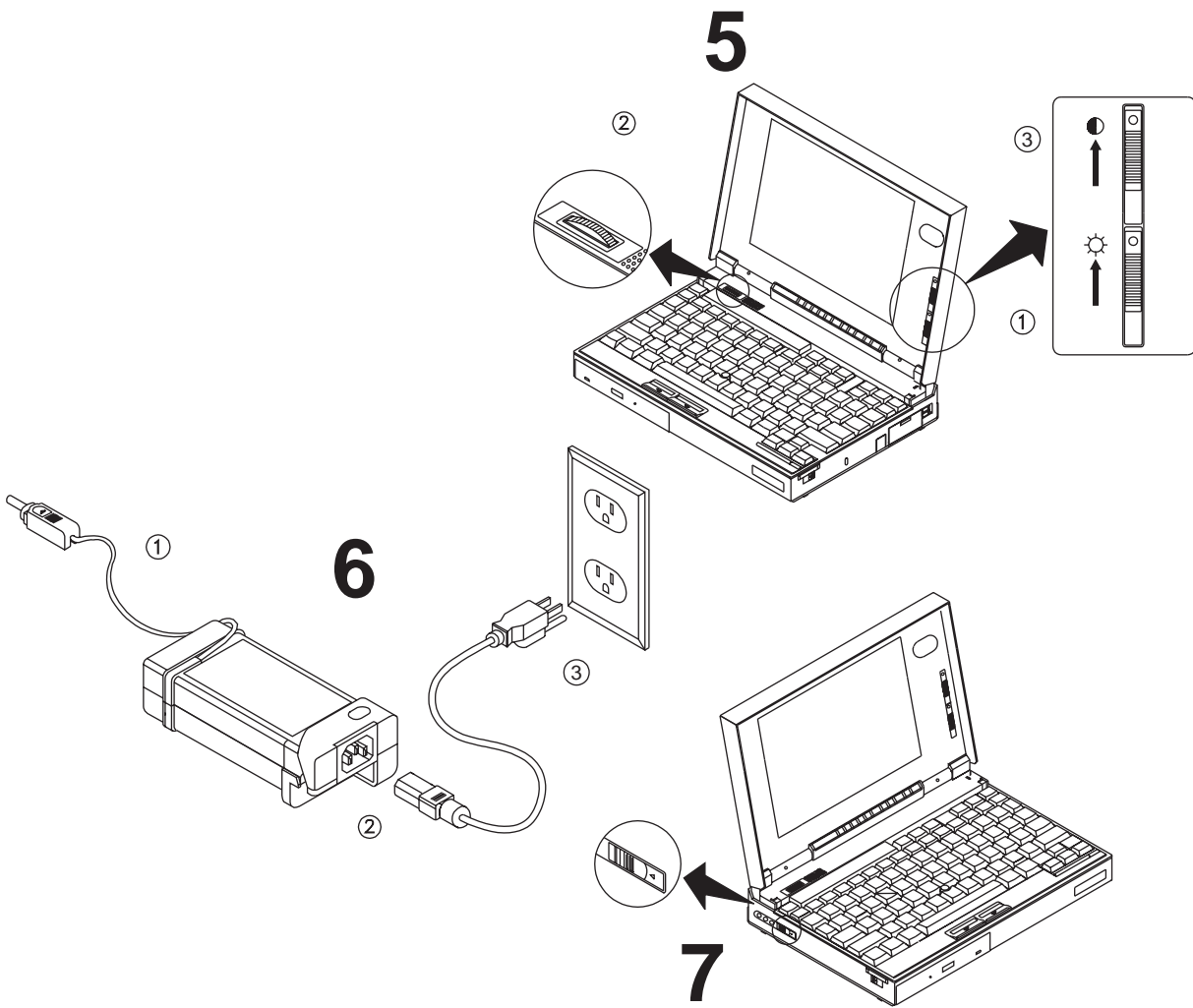

Getting Started

Congratulations! You have successfully completed the basic setup of your computer.

Important

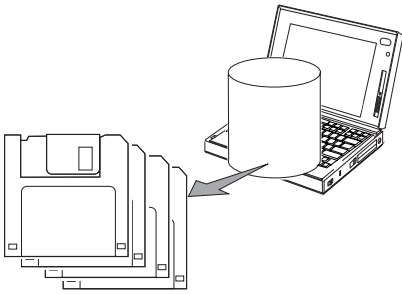

It is recommended that you make a backup copy of the files on the hard disk drive, in case you accidentally erase preinstalled software or intentionally modify the hard disk drive. You can use the backup copy to restore your computer to the way it was at the time when you made the backup copy.

In some countries, you can create the device driver diskettes you need to install all necessary software, using the Diskette Factory program. For more information on Diskette Factory, refer to Chapter 7, "Installing Software" on page 137.

Chapter 2. Getting Familiar with Your Computer

This chapter provides general information for getting acquainted with your computer.

- Locations 14
- System Status Indicators 19
- Providing Power 21
- Operating with the TrackPoint III 23
 - Cleaning the Cap 25
- Using the Fn Key Function 26
- Operating the Numeric Keypad 28
- Keeping the Computer from Being Damaged 29
- Carrying the Computer 30

Locations

Locations

8 To install PC Cards:

 Page 115.

9 To use the hardware lock:

 Page 102.

12 To use the TrackPoint III:

 Page 23.

15 To use Fn functions:

 Page 26.

This section describes additional features of your computer.

Front View

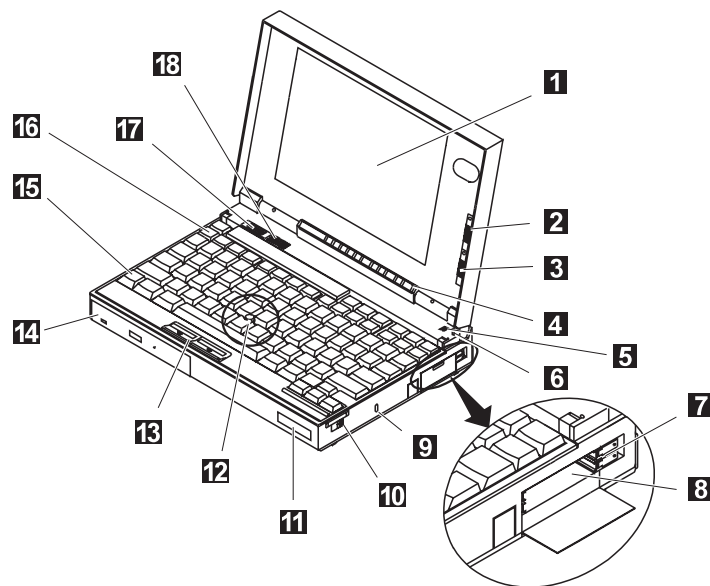

Locations

- 1 The **color LCD screen**, uses either thin-film transistor (TFT) or dual-scan super-twisted nematic crystal (DSTN) technology (depending on the model) to display computer output in 800-by-600 resolution. High-resolution display modes can be used on the LCD or with an attached external display (see page 43).
- 2 The **contrast control** (available on some models) moves up or down to adjust the display contrast level.
- 3 The **brightness control** moves up or down to adjust the brightness of the display.
- 4 The **indicator panel** consists of the system status indicators and their related symbols. These indicators show the current status of the computer.
- 5 The **built-in microphone** provides audio capturing capability when it is used with an application program capable of handling an audio function.
- 6 The **LCD suspend switch** sets the computer to enter suspend mode when the LCD is closed. **Do not manually press this switch at any time; the switch is automatically pressed when you close the LCD.**
- 7 The **PC Card eject buttons** eject the PC Card from the upper or lower PCMCIA slots.
- 8 **PC Card slots**
See "Checking Your Items" on page 4.
- 9 The **locking device keyhole** is used when securing the ThinkPad with a Kensington** MicroSaver** Security System (hereafter called the Kensington lock) or compatible lock. See page 102.
- 1 The **release latches** release the LCD screen or keyboard so they can be opened.
- 11 **Personalization nameplate** See page 103.
- 12 The **TrackPoint III** is a built-in pointing device that is as easy to use as a mouse without adding external devices to the system.
- 13 The **click buttons** are used with the TrackPoint III.
- 14 The **CD-ROM drive or diskette drive**. See "Checking Your Items" on page 4.
- 15 The **Fn key** is used with a function key to activate certain functions. See page 26.
- 16 The **function keys** can be used with or without the Fn key to activate various functions.
- 17 The **speaker volume control** adjusts the speaker volume from no sound to maximum volume.
- 18 The **speaker** provides sound for your application programs.

Locations

1 Using CD-ROMs:

 Page 58.

4 To replace the battery:

 Page 65.

5 To install an optional memory module (DIMM):

 Page 119.

6 To secure your computer:

 Page 102.

Inside View

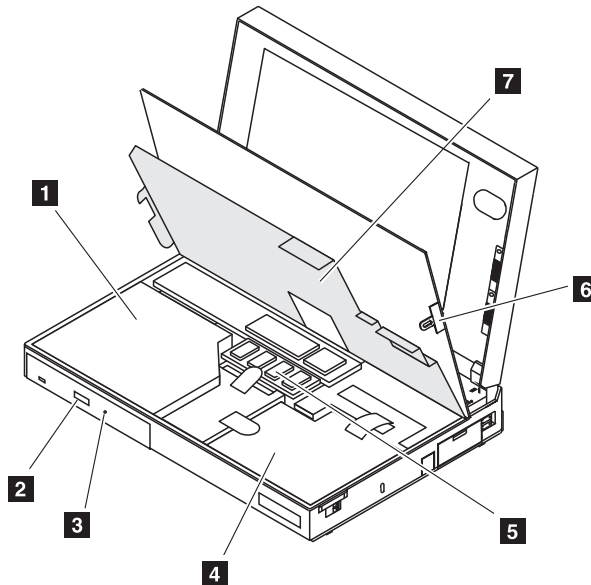

1 A **CD-ROM drive** that reads data from a 5.25-inch CD-ROM or a **diskette drive** that reads data from 3.5-inch diskettes.

2 The **CD-ROM eject button** releases the CD-ROM tray for inserting, removing, or replacing a compact disc.

3 The **mechanical CD-ROM eject** allows removal of a CD in the event of a power failure, which could disable the electronic eject button. To open the CD-ROM tray, insert a pin into this hole and push.

4 The **battery pack** allows you to operate the computer when ac power is not available.

5 The optional **dual-inline memory module (DIMM)** increases system memory capacity.

6 The **keyboard lock** prevents the keyboard from opening.

7 The **insulator sheet** covers the internal devices to protect the devices from harm.

Bottom View

- 1 The **legs** are used to adjust the keyboard angle.

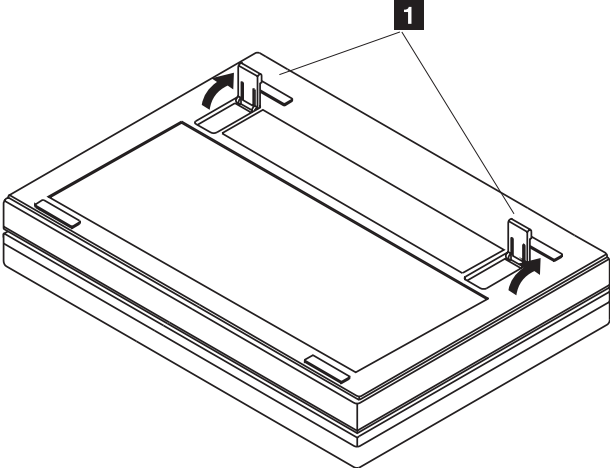

Locations

- 4 To attach an external keyboard, mouse, or numeric keypad:

 Page 125.

- 5 To attach a display:

 Page 45.

- 7 To attach a printer:

 Page 128.

- 8 To attach an external diskette drive:

 Page 57.

- 9 To connect the AC Adapter:

 Page 21.

Rear View

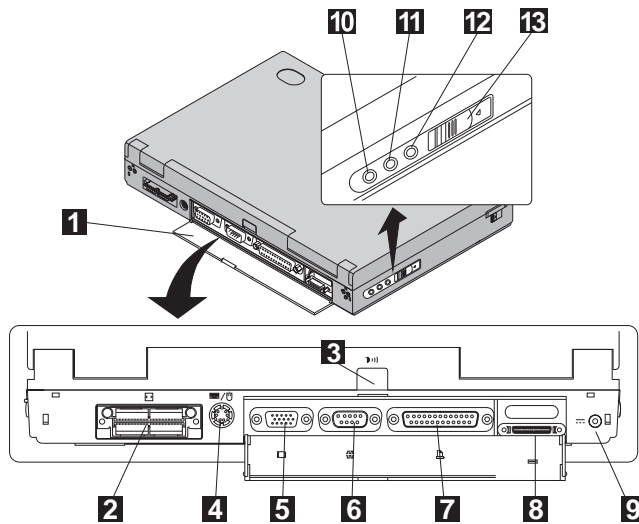

1 The **rear door** covers the connectors on the rear of the computer.

2 The **expansion connector** allows connection of the Port Replicator.

3 **Infrared (IR) port**
See page 54.

4 The **external input-device connector** is where a mouse, an external numeric keypad, or the keyboard/mouse connector is plugged in. An external keyboard can also be connected through the keyboard/mouse connector.

5 **External display connector**
See page 45.

6 **Serial connector**
See "Checking Your Items" on page 4.

7 **Parallel connector**
See page 128.

8 **External diskette drive connector**
See page 57.

9 The **power jack** is where the AC Adapter cable is connected.

10 **Line-out/headphone jack**

11 **Line-in jack**

12 **Microphone-in jack**





13 The **power switch** turns the computer on and off.

System Status Indicators

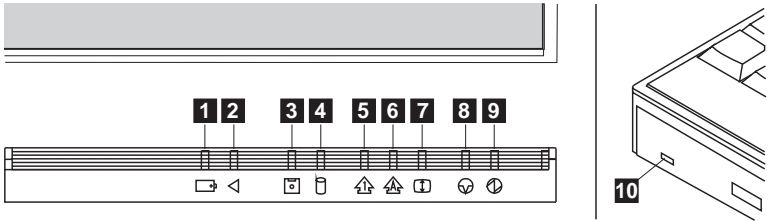



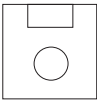

The system status indicators show the current status of your computer by their on or off states or colors (green and amber). Each indicator is identified with a symbol.

The following shows the location of each symbol and the meaning of each indicator.



Symbol	Color	Meaning
1 Battery Power Status 	Green	Indicates that sufficient power remains for operation. The battery power status cannot be determined when the battery is not installed in the computer.
	Blinking Amber	Indicates that the battery pack needs charging. When the indicator starts blinking amber, the computer beeps three times.
2 Battery Charging 	Green	Indicates that the battery pack is charging. When the indicator turns off, the battery pack is fully charged.
	Off	Indicates that the battery pack is charged (if the AC Adapter is attached).
3 Diskette Drive In Use 	Amber	Turns on when data is written to or read from the internal diskette drive.
4 Hard Disk In-Use 	Amber	Turns on when data is read from or written to the hard disk or internal CD-ROM. Do not enter suspend mode or turn off the computer when this indicator is on.
5 Numeric Lock 	Green	When on, indicates the numeric keypad on the keyboard is enabled. You enable and disable the keypad by pressing and holding the Shift key. Then press the NumLk key. For more information about the numeric keypad, see page 28.

System Status Indicators

Symbol	Color	Meaning
6 Caps Lock 	Green	When on, indicates the Caps Lock mode is enabled. All alphabetic characters (A–Z) are entered in capital letters without pressing the Shift key. You enable and disable Caps Lock mode by pressing the Caps Lock key.
7 Scroll Lock 	Green	Alternately turns on and off each time the Scroll Lock key is pressed. While this indicator is on, the Arrow keys are used as screen-scroll function keys. In this state, the cursor cannot be moved with the Arrow keys. Not all application programs support this function.
8 Suspend Mode 	Green	When on, indicates the computer is in suspend mode. For more information about suspend mode, see page 73.
	Blinking Green	Indicates that the computer is entering suspend mode or hibernation mode, or the computer is resuming normal operation.
9 Power On 	Green	Shows that the computer is operational. This indicator turns on when the computer is turned on and the computer is not in suspend mode.
1 CD-ROM Drive/Diskette Drive In Use	Amber 	Turns on when data is read from a CD in the CD-ROM drive. Do not enter suspend mode or eject the CD when this indicator is on.
	Amber 	Turns on when data is read from or written to a diskette in the internal diskette drive. Do not enter suspend mode or eject the diskette when this indicator is on.

Providing Power

You can use your computer almost anywhere: at home, in the office, or on the road. Different power sources can be used for different conditions: the AC Adapter, battery pack, or the Port Replicator. When you have access to an electrical outlet, you can use the AC Adapter for continuous power. Otherwise, you can use the battery pack.

AC Adapter

The AC Adapter is an alternating current (ac) to direct current (dc) converter that supplies power for the computer. The AC Adapter also charges the battery pack when it is installed in the computer.

Attention:

Always use the AC Adapter certified by IBM in the country where you will be using the computer. Operating the computer with an incorrect AC Adapter can cause damage to the battery pack and to the computer.

The AC Adapter is permanently sealed and cannot be repaired.

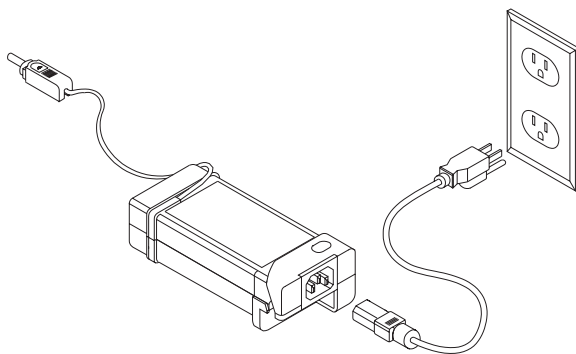

The input voltage is 100–240 V ac, 50/60 Hz. Refer to the label on your AC Adapter for the input voltage, and make sure you use the AC Adapter with the stated input voltage.

Providing Power

Note:

The optional Port Replicator can also be used to charge the batteries. When the computer is connected to the Port Replicator, the Port Replicator recharges the batteries as long as it is powered. For details, see page 131.

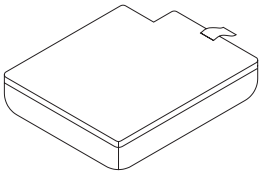

Battery Pack

The battery pack is an internal power source for the computer when no electrical outlets are available. The battery pack can be recharged with the AC Adapter.

The approximate operating time of the computer with a fully charged battery pack depends on the applications used, whether power management is used, the frequency of keystrokes, and the configuration of the system.

To ensure the longest possible battery life, in terms of both length of use per charge and number of charge and discharge cycles before wearing out, please observe these guidelines:

Battery packs shipped from the factory are in an almost-discharged state, so you *must charge* them fully before use.

When charging, always charge the battery pack fully. Even if you only need to run on battery power for a fraction of the battery's capacity, you should not try to give the battery a partial charge.

Normal charging causes the battery pack to heat up slightly. Let it cool for 15 minutes before you use it.

Do not recharge a partially drained battery; always drain the battery pack completely before recharging.

Immediately after the battery pack has been drained of power, it may be warm to the touch. This is normal. However it should be set aside to cool for 15 minutes before recharging.

Operating with the TrackPoint III

Note:
No other software is required for the TrackPoint III; it works with the PS/2 mouse driver.

The keyboard contains a unique cursor-pointing device called the TrackPoint III. Pointing, selecting, and dragging all become part of a single process, so you need not move your fingers from their normal typing position.

The TrackPoint III consists of a stick **1** on the keyboard and a pair of click buttons **2** in front of the keyboard. The motion of the cursor is controlled by pressure applied to the stick in any direction within the plane of the keyboard; the stick does *not* move. The speed at which the cursor moves corresponds to the amount of pressure on the stick. The click buttons are similar in function to those on other pointing devices; what they do depends on the software that is used.

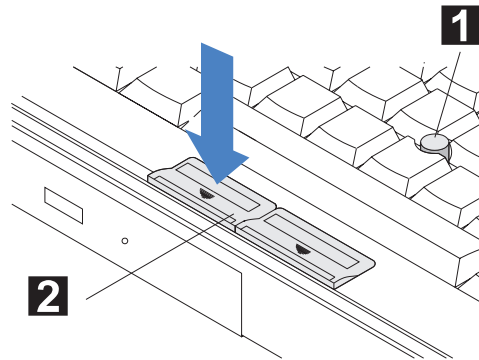

Operating with the TrackPoint III

If you are new to the TrackPoint III, these instructions will help you get started.

Note:
Remember that the stick does not move.

- 1** Place your hands in the typing position and press gently with either index finger in the direction in which you want the cursor to move.

Pressing the stick away from you moves the cursor up the screen; pressing it toward you moves the cursor down the screen.

Note:
Either thumb can be used.

- 2** Use the click buttons to select and drag as required by your software, in the same way as for any other pointing device.

You can *drag and drop* an item without having to continually hold down the click button. To do this, position the cursor over the item, press and hold the click button, then slide the button back (toward yourself) until it locks into place. Now you can drag the item without having to touch the click button. When the item is positioned where you want it, simply push the click button back in (away from yourself) to release it, and the dragged item drops into place.

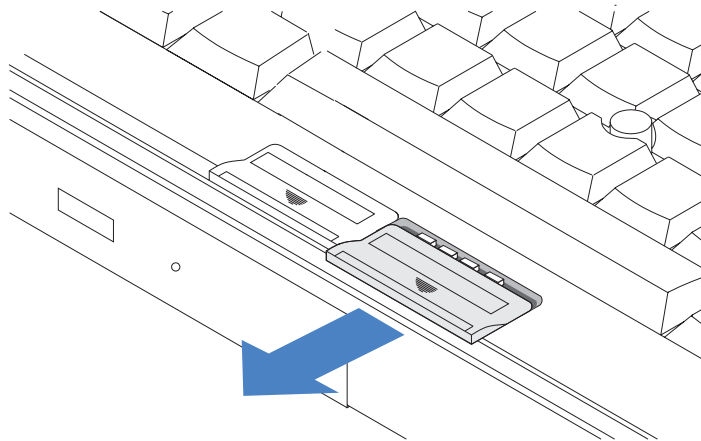

Cleaning the Cap

The cap on the end of the TrackPoint III is removable. You can replace it with one of the spares shipped with your computer when the cap is worn out.

To maintain a smooth pointing operation, occasionally clean the cap with a soft cloth moistened with a nonalkaline detergent.

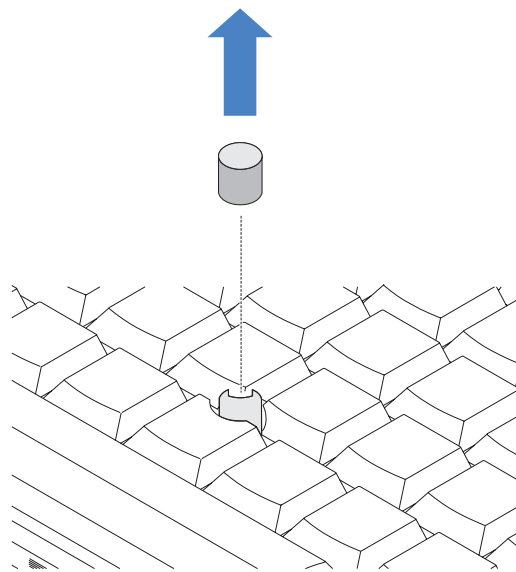

Using the Fn Key Function

Using the Fn Key Function

The **Fn** key function allows you to change operational features instantly. When you use the following functions, press and hold the **Fn** key **1**; then press the appropriate function key **2** (**F1** to **F12**; some function keys are reserved for future use.)

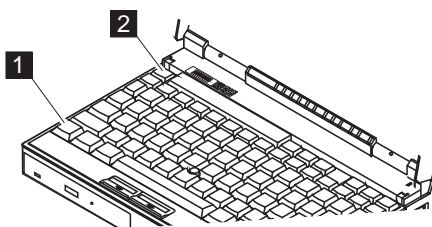

Note:























To use the Fn Key Lock function, select the **TrackPoint III** (🖱️) icon in the ThinkPad Features program window, or type `PS2 FNS E` at the command prompt.

Hints and Tips

Using the Fn Key Lock Function: You only need to press **Fn** once to get the same effect as when you press and hold the **Fn** key. After you press a function key in the top row, **Fn** returns to its normal state.

Key Combination	Feature	Meaning
+	Reserved	—
+	Fuel-Gauge display on or off 	The Fuel-Gauge program must be activated before you can use this key combination. When this key combination is pressed: For OS/2 or Windows users: The window for the battery power status appears or disappears. Parameters for power status can be set.
+	Standby mode 	Places the computer in standby mode. For more information about this mode, see page 75.
+	Suspend mode 	Places the computer in suspend mode. For more information about this mode, see page 75.

Using the Fn Key Function

Key Combination	Feature	Meaning
 + 	Reserved	—
 + 	Reserved	—
 + 	LCD/external monitor switching 	Displays the computer output in the following order when an external monitor is attached. External Both Display LCD
 + 	Reserved	—
 + 	Reserved	—
 + 	Reserved	—
 + 	Power mode switching 	When this key combination is pressed during battery-power operation, the power-management (power-saving) mode changes as follows. High Auto Customize AC mode is used when the AC Adapter is attached. The Fuel-Gauge program displays the current power option. See page 68.
 + 	Hibernation mode 	Places the computer in hibernation mode. See “Hibernation Mode” on page 79 for more information.
 + 	Reserved	—
 + 	Reserved	—

Operating the Numeric Keypad

Operating the Numeric Keypad

The keyboard has some keys that, when enabled, work as a 10-key numeric keypad.

To enable the numeric keypad, press and hold **Shift** and **NumLk**.

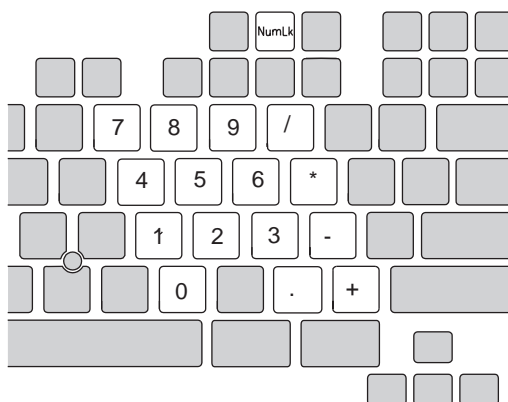

While in this mode, press and hold **Shift** to temporarily use the cursor and screen control keys.

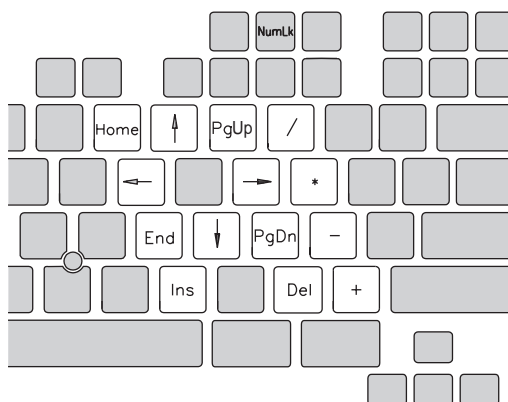

To disable the numeric keypad, press and hold **Shift**; then press **NumLk** again.

Keeping the Computer from Being Damaged

Your computer is a delicate device that requires careful handling. To keep it from being damaged, keep these precautions in mind:

Do not place anything heavy on your computer.

Do not scratch, twist, hit, or press the surface of the LCD.

Keep the computer at least 130 mm (5 in.) away from any electrical appliance that generates a strong magnetic field (for example, magnets, motors, TVs, refrigerators, or large audio speakers).

Use your computer when the temperature is from 10°C to 35°C (50°F to 95°F).

Remove the battery pack and keep it in a cool place if you do not plan to use the computer for a long period of time.

Do not disassemble the computer.

Do not leave any objects (especially metal objects) in the computer.

Do not pour liquids into the computer.

Do not drop or apply shock to your computer.

The hard disk drive, CD-ROM drive, and diskette drive are very delicate devices that need careful handling. To avoid damage, do not press on, drop, or apply any shock to them.

Do not press on the middle part of the CD-ROM drive or the diskette drive at any time.

Do not touch the lens on the CD-ROM tray.

Do not use benzene, thinners, or other cleaners to clean the lens on the CD-ROM tray. Use a CD-ROM cleaner kit.

Do not place more than one diskette label on a diskette. Two or more labels can cause a label to tear apart inside the drive and cause damage to the diskette drive.

Insert a diskette straight into the diskette drive. Inserting it at an angle can damage the front of the diskette drive.

Occasionally clean your computer as follows:

Use a soft cloth moistened with a nonalkaline detergent to wipe the exterior of the computer.

Gently wipe the LCD with a dry, soft cloth. Avoid using alcohol or detergent to clean the LCD.

Carrying the Computer

When carrying your computer, follow these instructions to prevent possible damage to your computer and data.

- 1** Remove any CD-ROM from the CD-ROM drive or any diskette from the diskette drive.
- 2** Turn off all attached devices.
- 3** Turn off the computer and close the LCD.
- 4** Unplug all external cables and cords connected to the computer.
- 5** Make sure all computer doors and covers are closed.

For Your Information

1. You should occasionally back up data from the hard disk to diskettes or tapes.
2. To use the AC Adapter outside your home country, you need an ac power cord that is certified for the country you are visiting. You can purchase one through IBM or an IBM authorized dealer in that country. For more information about power cords, see page 267.
3. A carrying case is available from IBM or an IBM authorized dealer.

Chapter 3. Operating Your Computer

This section provides information about using your computer.

What Happens When Power Is Turned On?	32
Using the ThinkPad Features Program	33
Starting the ThinkPad Features Program	34
Starting the Program for OS/2 and Windows	34
Starting the Program in DOS	36
Using Easy-Setup	37
Starting Easy-Setup	37
Using the Selectable Drive-Startup Sequence	41
Changing the Startup Sequence	42
Selecting the Network RPL Speed	42
Using the Computer LCD or the External Monitor	43
Display Output Type	43
Points to Consider When Using the DOS Screen on the LCD	44
Attaching a Monitor	45
Setting the Monitor Type and the Display Driver	46
Connecting an External Monitor to the Computer	47
Using SVGA Video Mode	48
Using PC Cards	49
PC Card Limitations under Suspend Mode	49
Using the PC Card Director Program	50
Starting PC Card Director for OS/2 or Windows	51
Starting PC Card Director for DOS	53
Using the Infrared Communication Feature	54
Points to Consider for Infrared Communication	54
Audio Features	56
Using the External Diskette Drive	57
Using the CD-ROM Drive	58
Handling Compact Discs	59

What Happens after Power-On?

What Happens When Power Is Turned On?

You see one of the following prompts when the computer is turned on:

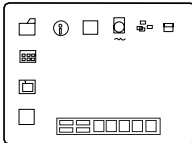
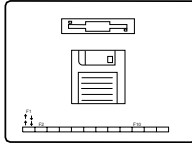
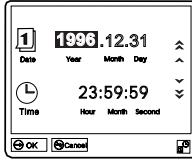
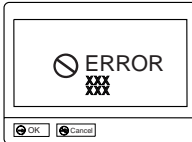
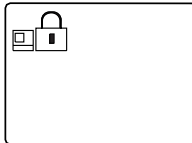
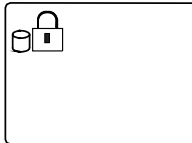
 <p>An operating system screen</p>	<p>An operating system screen appears when the computer is operating correctly. The screen you see may differ depending on your operating system.</p>
	<p>This screen appears when an operating system is not found. It instructs you to insert a self-starting diskette into the diskette drive and press F1 to start the diskette. The order in which the computer checks the drives for an operating system is set in the drive-startup sequence. See "Using the Selectable Drive-Startup Sequence" on page 41 for more information.</p>
	<p>This screen instructs you to set the date and time for the first time. Enter the date and time (see page 38); then press Enter.</p>
	<p>This screen indicates that a failure occurred during the power-on self-test (POST). See page 201 for the necessary actions.</p>
	<p>This icon appears when a power-on password is set. To start the computer, enter the correct password.</p>
	<p>This icon appears when a hard disk password is set. To unlock the hard disk drive, enter the correct password.</p>

Using the ThinkPad Features Program

Note:
When installing an operating system, you must also install the ThinkPad Features program.

To install the ThinkPad Features program:



Chapter 7.

ThinkPad Features is a control program that allows you to configure your computer. Using the ThinkPad Features program, you can easily set up and customize the built-in devices, such as the parallel port or infrared port.

It also provides the Device Configuration Management System that automatically detects a system resource (such as IRQ, DMA, I/O address, or memory) conflict, so that you can easily set up your computer configuration for the new device or software. For more detail about each device's resource, see Appendix A, "Avoiding Hardware Conflicts" on page 231.

ThinkPad Features also provides various features for your computer such as:

Power management detail settings

Screen resolution and color depth for both LCD and external monitor

Fuel-Gauge program

- Remaining power percentage
- Current power mode
- Discharge options

Fuel-Gauge program:



Page 68.

Personalization Editor program:



Page 98.

Personalization Editor

Alarm

Using the ThinkPad Features Program

Starting the ThinkPad Features Program

The way you start the ThinkPad Features program depends on the operating system.

If you are using OS/2 or Windows, you can use the ThinkPad Features program with a user-friendly graphical user interface. You can select or change any option in the ThinkPad Features program by simply clicking on the buttons on the screen with a pointing device. You can also specify features by entering the appropriate PS2 commands at the command prompt (see page 257).



Starting the Program for OS/2 and Windows

To start the ThinkPad Features program, double-click on the **ThinkPad Features** icon.

In the ThinkPad Features window, you can:

- Customize the settings for the one-touch setup buttons.

- View or set the configuration for the built-in devices. This allows you to detect or resolve system resource conflicts.







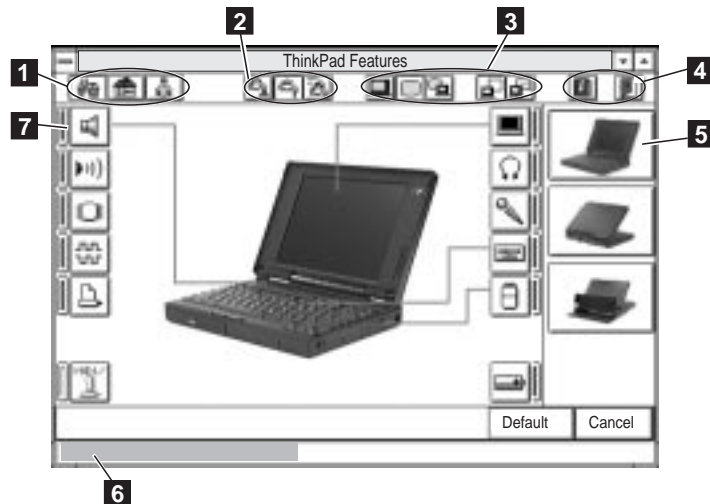



For your information

A *Help* button is available on the screen. For additional information on each menu item, click on the help button.

Note:
Any buttons on the screen that appear in gray are options that cannot be set.



Using the ThinkPad Features Program

- 1 **One-touch setup buttons.** Click on one of the buttons to set the system configuration automatically to fit your office () , or your home () , or to customize it () .
- 2 **Power mode buttons for battery operation.** Click on one of the buttons to set the power mode for battery operation to high performance mode () , automatic mode () , or customized mode () .
- 3 **Display device buttons.** Click on one of the buttons to set the display output type to the LCD () , external monitor () , or both () .
When making a presentation, you can click on the presentation button () to disable any system timers, such as turning the LCD off or entering a power-saving mode.
- 4 **Help or save button.** Click on the left button for help. Click on the right button to save the changes made and to exit the ThinkPad Features window.
- 5 **View angle buttons.** Click on the buttons representing the front, rear, or Port Replicator view to display the devices and connectors from that computer view.
- 6 **Status bar.** When you place the cursor on a device button, the device name and its status appear in this status bar.
- 7 **Device buttons.** Click on the button of your choice from the screen; then set the options for that device in the window that appears.

When the device is enabled, the red indicator next to the icon is lit. Otherwise, the device is disabled.

Click on the **Cancel** button to exit ThinkPad Features without saving the changes. Click on the **Default** button to set the default values for each option and cancel the changes you have made.

When you press the minimize button in the top-right corner () , the following Tool Bar view is displayed.

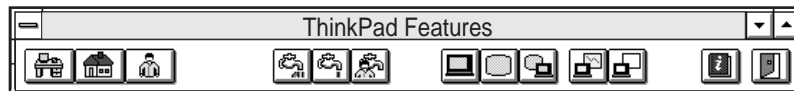

Using the ThinkPad Features Program

D O S

Starting the Program in DOS

The ThinkPad Features program for DOS is a command line interface, so you can specify features by entering appropriate commands. Type `PS2 ?` at the DOS prompt to display the ThinkPad Features online help.

Notes:

1. You can use the PS2 commands from the command prompt in OS/2.
2. This menu screen might look different on your system.

```
C:\>PS2 ?

(C) Copyright IBM Corp. 1993,1995. All rights reserved.
  US Government Users Restricted Rights - Use, duplication
  or disclosure restricted by GSA ADP Schedule Contract
  with IBM Corp.

Command Syntax: PS2 [Parameter1] [Parameter2] [Parameter3]

Following are available [Parameter1].
For the complete command syntax, type 'PS2 ? [Parameter]'.

1. Power Management related
```

You can select an item from the menu and follow the instructions on the screen to set any of the features. For details on the commands, see page 257.

You can create a batch file to set your unique operating environment quickly and easily.

The following example batch file allows you to set up an operational environment that is suitable for traveling and can result in longer battery operation time.

Note:

Refer to the manuals supplied with the operating system for more information on batch files.

```
@Echo Off

Rem SAMPLE: Set the parameters to provide maximum power utilization.
Rem =====
      PS2 PMode Auto           > Nul
      PS2 LCd 3                > Nul
      PS2 DISK 3               > Nul
      PS2 POver 5              > Nul
      PS2 SPeed Fixed MIN     > Nul
      PS2 SStandby 3          > Nul
      PS2 IR OFF               > Nul
      PS2 CARD OFF            > Nul
      PS2 SERial OFF          > Nul
```

Using Easy-Setup

The computer has a built-in system setup function called *Easy-Setup*. Easy-Setup allows you to set the date and time, passwords, and the startup sequence of the drives. It also shows hardware configurations. Easy-Setup also runs the diagnostics.

Starting Easy-Setup

To start Easy-Setup:

- 1 Turn off the computer.
- 2 Remove any diskette from the diskette drive.
- 3 Press and hold **F1**; then turn on the computer. Hold **F1** until the *Easy-Setup* menu appears.

Note:

You can change the screen color of the *Easy-Setup* menu with the key combinations of **Ctrl+PgUp** or **Ctrl+PgDn**. Use **Ctrl+Home** to restore the original screen color.

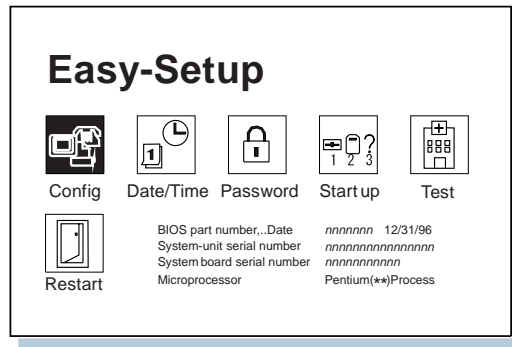

To select an item from the *Easy-Setup* menu, move the pointer with a pointing device to the item and click on the item or use the keyboard as follows:

Arrow keys (↑↓←→): Highlight the item from the menu.

Spacebar: Selects the item.

Enter key: Enters the next menu, or saves the changes and exits the menu.

Esc key: Returns to the previous menu, or cancels the changes.

Using Easy-Setup



Config contains the following:

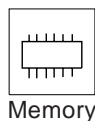
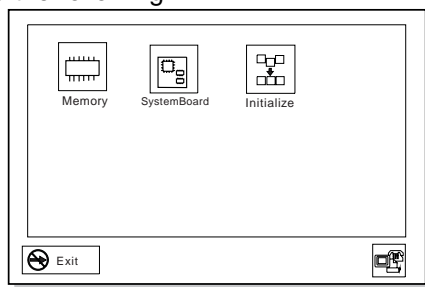

Memory shows the amount of installed memory and available memory.

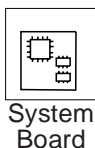

SystemBoard provides information about the installed system board.

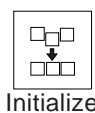

Initialize sets all items that have been changed back to their default values.

After verifying your selections, click on **OK** or press **Enter**. To cancel the selections, press **Esc**.



Date/Time is used to set the current date and time.

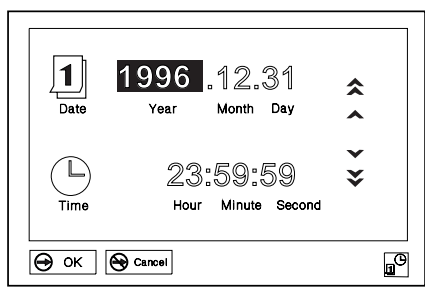

Select any field (Year, Month, Date, Hour, Minute, or Second) with the **Arrow** keys or pointing device; then type or click on the **▲** or **▼** icon to change the setting. Clicking on the **▲** or **▼** icon changes the setting more quickly.

Using Easy-Setup

After verifying the selection, click on **OK** or press **Enter**. To cancel the setting, click on **Cancel** or press **Esc**.



Password is used to set the:

- Power-on password
- Hard disk password
- Supervisor password

Attention:

When you set the hard disk password, do not forget your hard disk password.

*If you forget it, there is **no way to reset your password or recover data from the hard disk**. Neither an IBM authorized reseller nor IBM marketing representative can make the hard disk drive usable.*

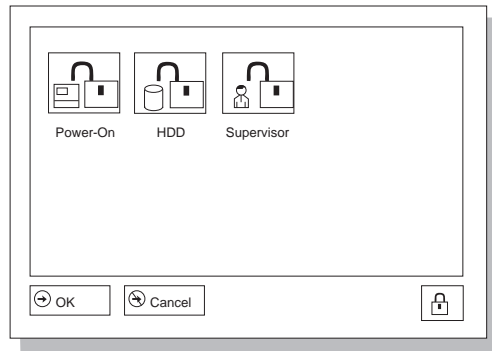

For more information about passwords, see Chapter 5.

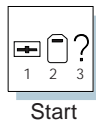

Start up is used to change the startup sequence of your computer.

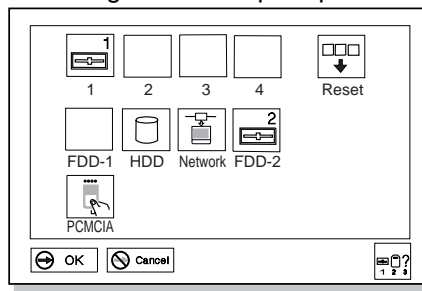

For more information about the startup sequence, see “Using the Selectable Drive-Startup Sequence” on page 41.

Using Easy-Setup



Test

Note:

The **FDD-1** icon represents the diskette drive in the computer. The **FDD-2** icon represents the externally attached diskette drive.

Select **Test** to test the computer hardware.

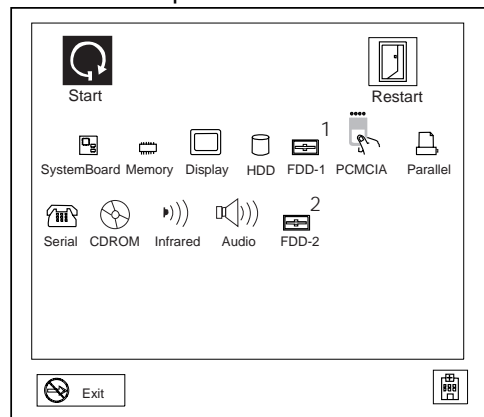

For more information, see “Testing the Computer” on page 193.



Restart

Click on **Restart** to restart the computer after you have made your selections. Then press **Enter** or click on **OK**.

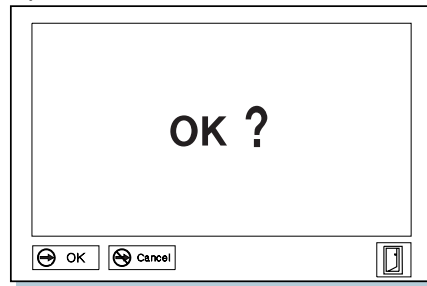

Using the Selectable Drive-Startup Sequence

Attention:

If you change your startup sequence, you must be extremely careful when you do write operations (such as copying, saving, or formatting). Your data or programs can be overwritten if you select the wrong drive.

Selectable drive startup (*selectable boot*) allows you to control the startup sequence of the drives in your computer. The order in which the computer searches the drives for your operating system is the *drive-startup sequence*. If you are working with multiple operating systems, you might want to change the drive-startup sequence to load an operating system from the hard disk or a PC Card without checking the diskette drive, or to do a remote program load (RPL).

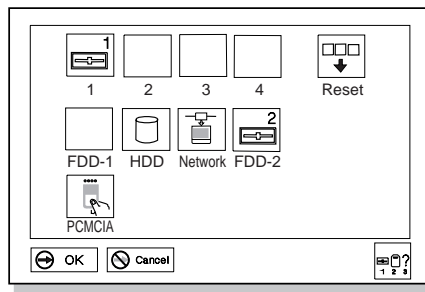

FDD-1 represents the first diskette drive found during system startup. When no diskette drive is installed in the system, and if an external diskette drive is attached, the external diskette drive will be **FDD-1**.

Using Easy-Setup

To start Easy-Setup:



Page 37.

Note:

You cannot set a hard disk drive before a *PCMCIA* card in the startup sequence.

Changing the Startup Sequence

To change the startup sequence:

- 1** Start Easy-Setup and select the **Start up** icon.
- 2** Move the cursor to the **Reset** icon; then press the **Spacebar**.
The sequence is reset, and all available device icons appear at the bottom of the screen. For the meaning of the icons, see page 39.
- 3** Move the cursor to the icon for the first device in the startup sequence; then press the **Spacebar**.
Repeat this step to set the other devices for the startup sequence. You can set up to four devices.
- 4** To save the change, click on **OK** or press **Enter**.

Selecting the Network RPL Speed

When you use a remote program load through a token-ring card or other network card, you can select the RPL speed.

- 1** Start Easy-Setup and select the **Start up** icon.
- 2** Move the cursor to the **Network** icon; then press the **Spacebar**.
The window to select the token-ring RPL speed appears.
- 3** Move the cursor to the **4** icon or the **16** icon; then press the **Spacebar** and press **Enter**.
If you are using another card, such as an Ethernet card, press **Esc** to exit this window.

Using the Computer LCD or the External Monitor

This section provides information about using the computer display and an external monitor. It also provides tips to consider when using DOS applications.

The LCD in your computer displays computer output with SVGA (800-by-600 resolution). On some models, thin-film transistor (*TFT*) technology is used, providing up to 65,536 colors. On some models, dual-scan super twisted nematic (*DSTN*) technology is used, providing up to 256 colors.

Display Output Type

To attach an external monitor:



Page 45.

When you attach an external monitor that supports higher resolution than VGA mode, you can get a maximum of 1024-by-768 video resolution.

To display your computer output on an external monitor, you need to set the appropriate *display output type* (where to display the computer output). You can select one of the following display output types:

LCD (): The computer output is displayed only on the LCD of the computer.

CRT (): The computer output is displayed only on the attached external monitor.

If no external monitor is attached to the computer and the display output type is set to *CRT*, the output is displayed on the LCD.

Both (): The computer output is displayed on both the LCD and the external monitor.

You can select where to display computer output among the LCD, the external monitor, or both by using the following commands:

Using the Fn key function: Press and hold the **Fn** key; then press the **F7** key. The output is displayed sequentially as follows:



```
External      Both
Display

LCD
```

Using the Computer LCD or the External Monitor



Using the ThinkPad Features program:

1. Start the ThinkPad Features program.
2. Click on the following icons from the tools bar:
 - The **CRT** () icon to display information on the external monitor.
 - The **LCD** () icon to display information on the LCD.
 - The **Both** () icon to display information on both the LCD and external monitor.



Entering a PS2 command from the command prompt:

- Enter `PS2 SC BOTH` to display information on both the LCD and external monitor.
- Enter `PS2 SC CRT` to display information on the external monitor.
- Enter `PS2 SC LCD` to display information on the LCD.

Points to Consider When Using the DOS Screen on the LCD

When you use a DOS application that supports only VGA mode (640-by-480 resolution) with your computer, the screen image might look slightly distorted or might appear smaller than the display size, as shown:

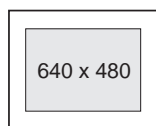

This is to maintain compatibility with DOS applications.

Attaching a Monitor

PS2 command for screen expansion:



Page 260.

ThinkPad Features program:



Page 33.

Note:

For the standard video model, when display is set to 640-by-480 resolution and 65,536 colors, screen expansion is not available.

To expand the screen image to the same size as the actual screen, you can use the *screen expansion* function. The screen expansion can be selected when you click on the **Display** button () in the ThinkPad Features program. However, the image may look slightly distorted.

Attaching a Monitor

Note:

When installing an operating system, you must install the display driver before you can use an external monitor.

Your computer supports the following color depth and resolution on an attached SVGA monitor:

Color	Resolution
256 colors	640 by 480
	800 by 600
	1024 by 768
65,536 colors	640 by 480
	800 by 600
16,777,216 colors (See note.)	640 by 480

Note:

To use 16,777,216 colors, set the display output type to

CRT ()

To install the display driver:





Chapter 7.

Attaching a Monitor

Attention:

When you select **Both**, do not attach an external monitor that supports only VGA mode (640-by-480 resolution). Otherwise, the external monitor screen will be scrambled and the output will not be displayed, or the screen might be damaged.

To attach an external monitor:

- 1 Change the display output type to **CRT** () or **Both** (). (See “Display Output Type” on page 43.)
- 2 Set your monitor type and display device driver. (See “Setting the Monitor Type and the Display Driver” on page 46.)
- 3 Attach the external monitor to the computer. (See “Connecting an External Monitor to the Computer” on page 47.)



Setting the Monitor Type and the Display Driver

Before attaching the external monitor to your computer, set the appropriate monitor type and device driver type as follows:



Note:

Refer to the specifications for your external monitor to determine its supported resolutions and refresh rates.

- 1 Start the ThinkPad Features program.
- 2 Click on the **Display** ( or ) icon.
- 3 Click on the **Advanced...** button.
You can select your display type from the monitor list, or click on a new resolution or refresh rate.
- 4 Restart the computer to make the changes effective.

Important

When you are using OS/2 Warp, do not use **System** in the System Setup folder to change the resolution or color depth. Use the ThinkPad Features program to configure the display.

Hints and Tips

When you are using OS/2 or Windows, the *virtual screen* function is available with the ThinkPad Features program. It is used to display a part of the high-resolution screen image that is produced by the computer. Other parts can be seen by moving the screen with the TrackPoint III or other pointing device.

Attaching a Monitor

Connecting an External Monitor to the Computer

Attention:

Do not disconnect the external monitor while the computer is in suspend mode or hibernation mode. If no external monitor is attached when the computer resumes, the LCD will remain blank and the output will not be displayed. This does not depend on the resolution value.

To attach an external monitor to the computer:

- 1** Turn off the computer.
- 2** Attach the external monitor to the external monitor connector () and then to the electrical outlet.
- 3** Turn on the external monitor and the computer.

Using SVGA Video Mode

Using SVGA Video Mode

Some IBM ThinkPad 365X/365XD models have an LCD screen that supports an SVGA video mode with 800x600 resolution. You can also display information in higher resolutions by attaching an external monitor to your computer that supports higher resolutions.

When installing an operating system, you must install the display driver supplied with the computer to use SVGA mode.

When using the high-resolution mode, select **CRT** in the Display Menu of the Display Driver Control program.

The table shows the various display modes available with your computer.

Display Modes	TFT (1 MB)	DSTN (1 MB)
Resolution and Color Depth (LCD only)		
640x480 (full screen)	65,536	256
800x600 (full screen)	65,536	256
800x600 (virtual screen)	65,536	256
1024x768 (virtual screen)	256	256
External Resolution and Color Depth (CRT only)		
640x480	16,777,216	16,777,216
800x600	65,536	65,536
1024x768	256	256
Simultaneous Display (LCD / CRT)		
640x480	65,536 (LCD) / 65,536 (CRT)	256 (LCD) / 256 (CRT)
800x600	65,536 / 65,536	256 / 256
1024x768	256 / 256	256 / 256

Using PC Cards

To insert a PC Card:



Page 115.

PC Card Standard:



Page 239.

PC Card Director:



Page 50.

Your computer has two slots that allow you to install 68-pin, 85.6 mm × 54.0 mm (credit-card-size) PC Cards. With a PC Card, you can send and receive faxes, communicate via a network, or store data.

The PC Card slots of the computer conform to the PCMCIA Standard Release 2.1 that is defined as the hardware layer of the PC Card standard. Your computer also comes with the following basic set of drivers:

- Socket Services
- Card Services
- PC Card Director and common enablers

The PC Card slots operate at 5V and support the following:

- Type I, Type II, and Type III* PC Cards.
- 16-bit PC Card (PCMCIA 2.0,2.1/ JEIDA 4.1,4.2)

Note that the PC Card slots do not support 8-bit or 16-bit slave DMA PC Cards. Ask IBM or an IBM authorized dealer for more information about the different types of PC Cards.

For more information about PC Cards, see Appendix B.

PC Card Limitations under Suspend Mode

Although some PC Cards can be inserted or removed without turning off the computer (refer to the instructions that came with the PC Card), you *cannot* remove or install PC Cards during suspend mode.

Using the PC Card Director Program

Using the PC Card Director Program

Note:

When installing an operating system, install the PCMCIA device driver with the PCMCIA Features Diskette to use PC Card Director.

To install the PCMCIA device driver:



Chapter 7.

Note:

The PCMCIA.CRD file does not always list the latest PC Cards. If your PC Card is not listed, try using it with PC Card Director anyway.

The **Supported PC Cards** icon:



Page 52.

Your computer comes with an advanced IBM program for PCMCIA called **PC Card Director** that makes using PC Cards with your computer easier by:

Turning on and setting up a PC Card when you insert it in a PC Card slot (common enablers).

Showing what type of PC Card is in your computer.

Notifying you with a message, sound, and icons whenever a card is inserted or removed.

Allowing you to register an application program for a particular PC Card and starting the program automatically when the card is inserted.

Some PC Cards come with their own device driver that will set them up just like PC Card Director does. However, if these cards are supported by PC Card Director, you will not need their device drivers. The PC Cards that PC Card Director supports are listed in the **PCMCIA.CRD** file.

To see the PCMCIA.CRD file, click on the **Supported PC Cards** icon in the PC Card Director window. (The PCMCIA.CRD file can be accessed from OS/2 Warp and Windows 3.11.)

If your PC Card is not supported by PC Card Director, you must install the driver that came with your card. The card driver must be compatible with the PCMCIA Card Services Standard Release 2.1. Follow the instructions in your PC Card manual to install the driver.

Using the PC Card Director Program



Starting PC Card Director for OS/2 or Windows

To start PC Card Director, select the PC Card Director folder or window; then select the **PC Card Director** icon.

For OS/2:

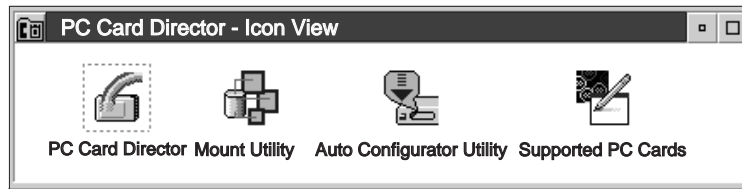

Note:
The screens shown here might look different depending on your operating system.

For Windows 3.11:

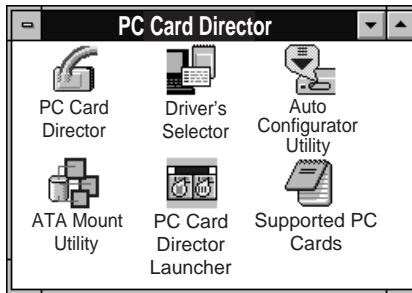

For Windows 95:



Using the PC Card Director Program

Note:

Supported icons and functions by PC Card Director are different depending on each operating system.



PC Card Director



Mount Utility



Auto Configurator

Note:

Refer to the PCMCIA.CRD file for a list of PC Cards that Auto Configurator can enable.



Supported PC Cards



Drivers Selector



PC Card Director Launcher

The PC Card Director program includes the following:

PC Card Director

The main program in the PC Card Director folder or window.

Mount Utility

This program controls the partitions in ATA PC Cards.

Auto Configurator

The Auto Configurator has prepared a script file for configuring each PC Card. These script files contain steps for enabling the PC Card and the resource information for its I/O interrupt level or memory. The Auto Configurator Utility is a utility that edits these script files, transforms them into binary data, and records them in Auto Configurator. Then Auto Configurator enables each PC Card, based on the data in the card's script file.

For more information on how to use the Auto Configurator, see Appendix B.

Supported PC Cards

This shows the PCMCIA.CRD file that lists all PC Cards supported by PC Card Director.

Drivers Selector

This program lets you modify the CONFIG.SYS file when you add or remove some PC Cards device drivers.

PC Card Director Launcher

You can register applications in this launcher (15 programs maximum).



Starting PC Card Director for DOS

To start PC Card Director for DOS:

- 1** Go to the DOS command prompt.

```
C:\>
```

- 2** Type `C:\THINKPAD\EZPLAY` at the command prompt; then press **Enter**.

Note:
C:\THINKPAD is the directory where PC Card Director is installed. If you have installed it in a different directory, type that directory name instead.

Communicating with the Infrared Port

Using the Infrared Communication Feature

To install the infrared device driver:



For OS/2: page 153.



For Windows: page 172.

Your computer is equipped with an infrared (IR) communication feature that allows point-to-point communication with other ThinkPad computers or systems equipped with an infrared port. The computer has an infrared port on the rear of the computer.

The infrared feature is designed to be compatible with IrDA** 1.0 mode at a data transfer speed of up to 115 Kbps (Kilobits per second). Your computer can communicate with a device that has a compatible infrared port, such as another ThinkPad, a Hewlett-Packard** 100LX**, 200LX**, or Omnibook** computer, or other IrDA-compliant systems.

To enable or disable the infrared port, use the ThinkPad Features program:

If you are using OS/2 or Windows, click on the

Infrared () icon in the ThinkPad Features window.

*If you are using DOS, type PS2 ? IR at the command prompt; then press **Enter** for more information.*

PS2 commands:



Page 36.

Points to Consider for Infrared Communication

Consider the following points when communicating with the infrared port:

When using the infrared port to communicate with the infrared port of another computer, the two infrared ports must face each other directly at a distance that allows for clear infrared communication (less than 1 meter apart for IrDA-compliant devices).

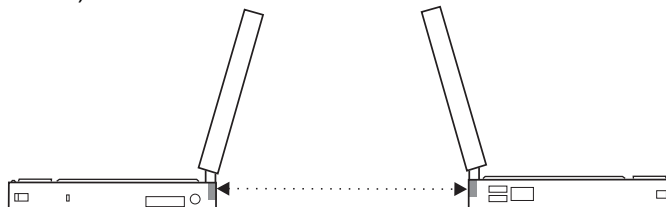

[Side view]

You need to run the same communication application on both computers to communicate between your computer and another

Communicating with the Infrared Port

computer device. Refer to the application manuals for more information.

Run only one communication application at a time that uses the infrared port.

The communicating distance might need to be closer if:

- The other system is not the same model as your computer.
- There is interference from ambient light. It is recommended that you do not use infrared communication in bright sunshine. Light from some fluorescent lamps can also interfere with infrared communication.
- The infrared port is not directly facing the other infrared port.

Cordless headphones that use infrared communication may interfere with infrared communication. When listening through the headphones and also operating the infrared port, you might hear interference or noise. Also, the headphones might cause the computer to lose communication with other devices.

Audio Features

Some models of the IBM ThinkPad 365X/365XD computer have built-in audio features that let you record and playback sound from various sources.

These features include:

- A built-in ESS AudioDrive Sound Chip on the system board, providing 16-bit stereo audio that supports OS/2 Warp, Microsoft Windows 3.1, Windows 95, Microsoft Sound System, and most programs that use the Sound Blaster/Sound Blaster Pro standard.

- The ability to perform real-time recording.

- Scalable sampling rate (from 4 to 44.1 kHz) and compression ratio that give complete control of record time to required storage ratio.

- Digitally controlled volume with muting.

- Microphone line-in jack, line-in jack, and line-out/headphone jack for maximum flexibility.

- Built-in microphone and speaker to enhance portability.

To adjust the volume of your internal speaker, speakers attached to the line-out port on the computer, or speakers attached to the line-out port on the Port Replicator, use the volume control at the lower-left corner of the LCD screen.

Using the External Diskette Drive



IBM ThinkPad 365XD models come with a built-in CD-ROM drive and an external diskette drive. This external diskette drive can be connected and used with or without the optional Port Replicator being present.

IBM ThinkPad 365X models (those without a built-in CD-ROM drive) come with the diskette drive already installed internally.

To install the external diskette drive, simply plug the diskette drive cable into the diskette drive port, located on the rear panel of the computer. The ThinkPad automatically senses the presence of the drive and configures itself accordingly.

Power to the diskette drive is provided through this connecting cable. The diskette drive does not have its own internal power source. It draws its power from the ThinkPad.

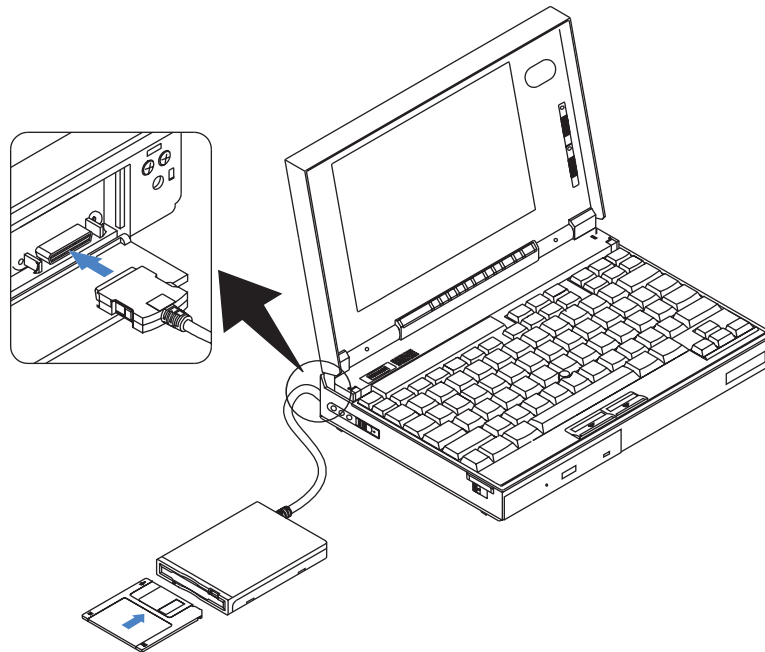

Using the CD-ROM Drive

Using the CD-ROM Drive



IBM ThinkPad 365XD models come with a built-in CD-ROM drive, so you can use compact discs (CDs).

The following CDs are supported by the computer:

- Music CDs
- Photo CDs
- CD-ROM or CD-ROM XA discs

Attention:

Hold the CD by the edges. Do not touch the surface of the CD.

To use the CD-ROM drive, do the following:

- 1** Turn on the computer.
- 2** Push the CD-ROM eject button on the front of the computer; then pull out the CD-ROM tray.
- 3** Carefully insert your CD-ROM onto the CD-ROM tray; then push the tray into the computer until it fully closes.
- 4** The way you access the data on the CD-ROM depends on what type of CD it is:
 - Music CDs can be played using the CD Player application program.
 - Data CDs can be read just like normal disks.
 - Photo CDs require specific application software.

Handling Compact Discs

Compact discs are high-density media that must be handled with care and kept clean to ensure that they remain readable. Keep in mind the following to maintain reliability:

Attention:

Wiping the compact disc in a circular direction can cause loss of data.

- 1** Hold the compact disc by the edges. Do not touch the surface of the compact disc.
- 2** To remove dust or fingerprints, wipe the compact disc from the center to the outside of the disc.
- 3** Do not write on the surface.
- 4** Do not store or place the compact disc in direct sunlight.
- 5** Do not use benzene, thinners, or other cleaners to clean the compact disc. Use a CD-ROM cleaner kit.
- 6** Do not flex or bend the compact disc.

Using the CD-ROM Drive

Chapter 4. Using Battery Power

This section describes the battery-pack operations.

Charging the Battery Pack	62
Charging with the AC Adapter	62
Battery Pack Maintenance	64
Replacing the Battery Pack	65
Monitoring the Battery-Power Status	67
Using the Battery-Power Status Indicator	67
Low-Battery Condition	68
Using the Fuel-Gauge Program	68
Fuel-Gauge Program for OS/2 or Windows	68
Preserving Battery-Pack Life	70
Maximizing Battery-Powered Operation	70
Using Advanced Power Management	70
Decreasing LCD Brightness	73
Using the Battery Power-Management Function	73
Standby Mode	75
Suspend Modes	75
Points to Consider for Suspend Mode	77
Hibernation Mode	79
Creating the Hibernation File	79
Points to Consider When Using Hibernation Mode	81

Charging the Battery Pack

Charging the Battery Pack

Note:
For more information on maintaining your battery packs, see page 64.

The battery pack can be charged with the AC Adapter. You must charge the battery pack in any of the following situations:

A new battery pack was purchased.

The battery status indicator (amber) is blinking, and the computer beeps three times.

The battery status indicator (amber) blinks for less than 1 minute; and then the suspend mode indicator turns on.

Charging with the AC Adapter

Note:
Battery packs shipped from the factory are in an almost-discharged state, so you must charge them fully before use.

The following table shows the approximate charging times for the battery pack:

Conditions	Charging Time
Operational charging	1.5 hours
Power-off charging	1.2 hours
Suspend-mode charging	1.2 hours

If the battery pack is new or has not been used for a long period of time, it does not reach full charge with only one charging. This is normal. When used regularly (at least once per week) and properly (as described on page 64), the battery pack will work its way back up to full capacity within five or six charge and discharge cycles.

Charging the Battery Pack

The following procedure describes how to recharge the battery pack with the AC Adapter when the computer is turned off.

- 1** Turn off the computer and open the keyboard.
- 2** Install the new or discharged battery pack into the computer.
- 3** Close the keyboard.
- 4** Connect the AC Adapter to the computer.

The system status indicators show the following:

Color	Meaning
On (green)	The battery pack is being charged.
Off	The battery pack is fully charged.

Charging the Battery Pack

Battery Pack Maintenance

Many users are familiar with the phenomenon known as *battery memory*, where after repeated partial charging and discharging the battery pack appears to lose some or all of its original capacity. The nickel/metal-hydrate (NiMH) battery packs used by the ThinkPad are less susceptible to memory development than are the more common nickel/cadmium (NiCd) batteries. However, to ensure the longest possible battery life, in terms of both length of use per charge and number of charge and discharge cycles before wearing out, please observe the following guidelines:

Battery packs shipped from the factory are in an almost discharged state, so ***you must charge them fully before use.***

When charging, always charge the battery pack fully. Even if you only need to run on battery power for a fraction of the battery's capacity, you should not try to give the battery a partial charge.

Normal charging causes the battery pack to heat up slightly. Let it cool for 15 minutes before you use it.

Do not recharge a partially drained battery; always use up the battery pack completely before recharging.

Immediately after the battery pack has been drained of power, it may be warm to the touch. This is normal. However, for longer battery life, it should be set aside to cool for 15 minutes before recharging.

Replacing the Battery Pack

When the AC Adapter is connected, you can replace the battery pack whenever it is low in power. Without the AC Adapter, the battery pack can be replaced when the computer power is off, or when the computer is in hibernation mode. To replace the battery pack during hibernation mode and without turning off the computer, follow these instructions.

To create the hibernation file:



Page 79.

Important

If you are using PC Cards, either connect the AC Adapter or stop the PC Card application and remove the PC Card before doing the following.

Make sure you have created the hibernation file before doing the following steps. Otherwise, you cannot enter hibernation mode. (See page 79.)

- 1** Enter hibernation mode by pressing the **Fn+F12** key combination.
Make sure the power-on indicator is *off* before you open the keyboard.
- 2** Open the LCD; then open the keyboard.
- 3** Locate the flexible tab at the rear end (nearest the LCD) of the battery; pull the tab to raise the battery out of its slot.

Replacing the Battery Pack

- 4 Lift the battery out of its slot and set it aside.

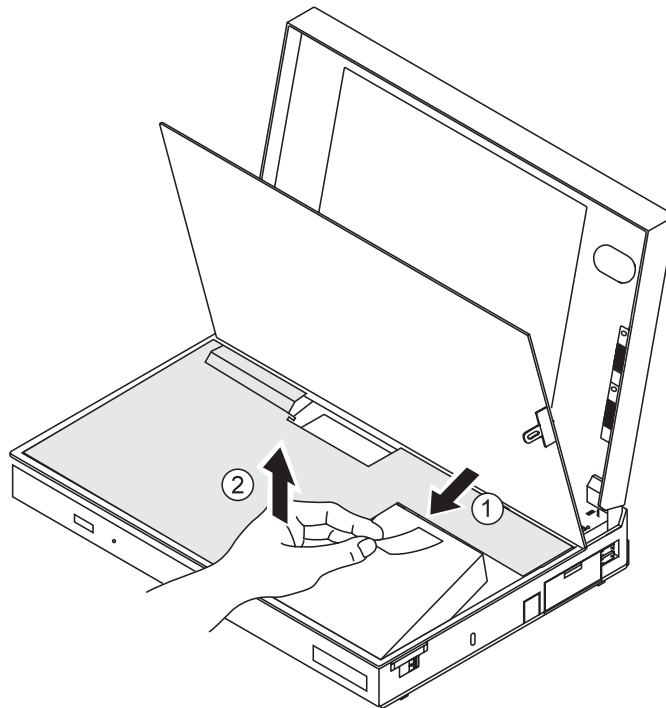

- 5 Place the fully charged battery into the slot with its forward end (away from the pull-tab) pointed down at an angle. Then press the rear end of the battery into place. The forward end of the battery should fit under, and be held in place by, a ridge on the inside of the ThinkPad case.
- 6 Close the keyboard.
- 7 Press the power switch.
The computer resumes normal operation from hibernation mode.

Monitoring the Battery-Power Status

The battery condition can be determined through the battery-power status indicator and the Fuel-Gauge program.

Using the Battery-Power Status Indicator

The battery-power status indicator shows the current status of the battery pack.

Observe the battery-power status indicator and compare it with the following status list to determine the battery condition:

Status	Condition	Action Required
Green	Fully charged or partially discharged.	Continue your work.
Blinking Amber	Approximately 5 minutes of power left. The amber indicator blinks until power fails or this low-battery condition is remedied.	Take either of the following actions within 1 minute: Connect the AC Adapter to the computer. Replace the battery pack with a fully charged spare.
Off	The battery pack is not installed, the computer is turned off, or the computer is in suspend mode.	If suspend mode is caused by a low-battery condition, data in memory can be lost. Do either of the following immediately. <i>To continue your work with the AC Adapter:</i> connect the AC Adapter to the computer and press the Fn key. <i>To continue your work with a fully charged battery pack:</i> connect the AC Adapter to the computer, replace the battery pack with a fully charged one. Then disconnect the AC Adapter from the computer.

Using the Fuel-Gauge Program

Low-Battery Condition

Attention:

Do not leave the computer in this condition for an extended period of time. Data in memory will be lost.

For necessary actions:



Page 67.

When the battery pack is low in power, the battery-power status indicator turns amber and begins to blink. At this point, you should complete all disk access operations before the battery runs out of power.

The battery pack needs to be charged immediately. If corrective actions are not taken within 1 minute, the computer enters Suspend mode.

Using the Fuel-Gauge Program

Note:

When installing an operating system, install the ThinkPad Features program by using the Utility Diskette. Then access the Fuel-Gauge program through the ThinkPad Features program.

To install the ThinkPad Features program:



Page 33.

The Fuel-Gauge program is another way you can monitor the battery-pack condition.

The Fuel-Gauge program appears on the screen with the following information about the battery pack:

- Power mode
- Battery status
- Suspend or hibernation options (for OS/2 and Windows)

Refer to the Fuel-Gauge program instructions appropriate for your operating system.



Fuel-Gauge Program for OS/2 or Windows

When you click on the **Fuel** icon in the ThinkPad Features program, the Fuel-Gauge program appears. You will see:

- The icon for the currently used power mode.
- A gauge showing the remaining battery capacity.
- The suspend button to enter suspend mode.
- The hibernation button to enter hibernation mode.

Using the Fuel-Gauge Program

The following shows how the Fuel-Gauge program appears with different power sources and when it is minimized to an icon.

Maximized Fuel-Gauge program:

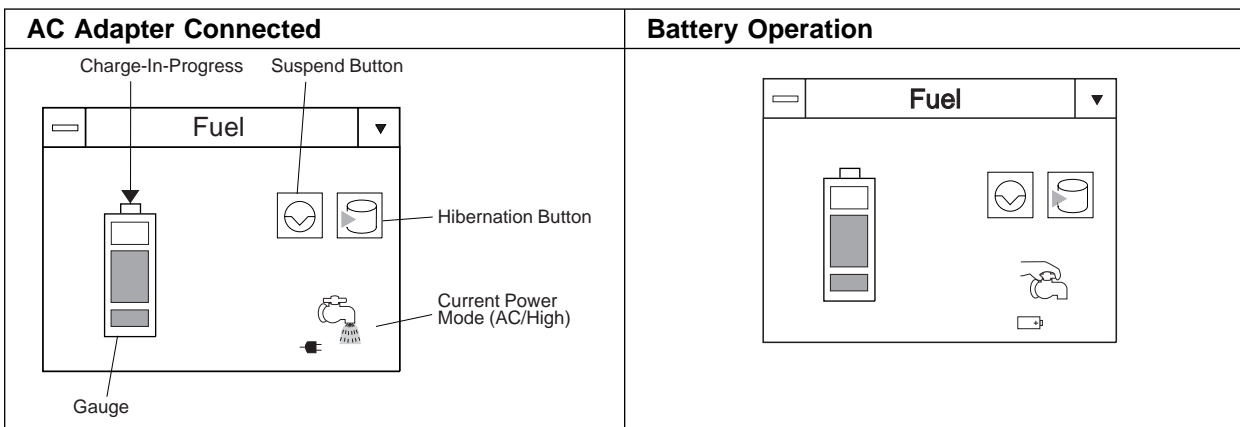

Minimized (to an icon) Fuel-Gauge program:

The power source (AC Adapter or battery) and power mode alternately appear:

Power Source

AC AC Adapter
BT Battery

Power Mode

HI High Performance
AU Automatic
CU Customized

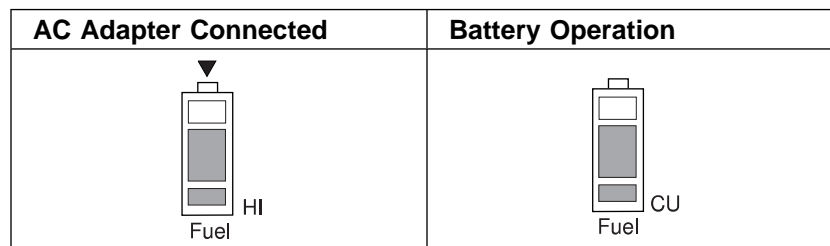

Maximizing Battery-Powered Operation

Preserving Battery-Pack Life

To preserve the life of the battery pack:

Attention:

Make sure the battery pack power is completely used before you recharge it. Recharging a battery pack that is not completely discharged can shorten battery life.

Do not charge the battery pack until all of its power is used.

Once you have started charging the battery pack, do not use it until it is fully charged.

Discharge the battery pack occasionally by using the Fuel-Gauge program.

Turn off the computer whenever it is not in use.

Maximizing Battery-Powered Operation

To save battery power:

Use Advanced Power Management (APM)

Decrease the LCD brightness

Use the Battery Power-Management function

Using Advanced Power Management

Note:

If you have purchased this computer with a preinstalled operating system, APM is already installed correctly.

The computer has power-management functions built in. No special power-management drivers have to be installed before you use the computer. However, the computer is able to conserve more power when Advanced Power Management (APM) is used.

APM allows you to reduce power consumption when your applications and devices are idle. Each operating system comes with its own APM.



If you are using OS/2, APM is automatically installed when the installation program detects that the power-management function is installed on your computer.

Maximizing Battery-Powered Operation

D O S

If you are using DOS, APM is automatically installed when the installation program detects that the power-management function is installed on your computer. To verify that the computer has APM installed correctly, type `power` at the command prompt and press **Enter**. If a screen similar to the following appears, APM is successfully installed.

```
Power Management Status
-----
Setting = ADV: REG
CPU: idle 32% of time.

AC Line Status : OFFLINE

Battery status : High
```

If not, add the following line to your CONFIG.SYS file, using a text editor such as the DOS Editor.

```
DEVICE=C:\DOS\POWER.EXE
```



If you are using Windows, follow these instructions to check and install APM for Windows:

1. Start the system. Make sure that the current directory is Windows (usually `C:\WINDOWS>`).
2. Type `SETUP` at the command prompt and press **Enter**. The following screen appears.

```
Windows Setup
=====

If your computer or network appears on the Hardware Compatibility List
with an asterisk next to it, press F1 before continuing.

System Information
Computer:      MS-DOS   System
Display:      Cyber932  8  x6   256 small font
Mouse:        Microsoft, or IBM PS/2
```

Maximizing Battery-Powered Operation

Note:

If "MS-DOS System with APM" appears for the item "Computer:", APM is already installed. Press F3 to exit the setup.

- Using the Arrow keys (↑, ↓), position the highlighted cursor on **MS-DOS System** and press **Enter**.
- Position the highlighted cursor over **MS-DOS System with APM** and press **Enter**.
- Verify that the item *Computer* has changed to **MS-DOS System with APM** on the screen. If not, return to step 3 on page 72.

```
Windows Setup
=====

If your computer or network appears on the Hardware Compatibility List
with an asterisk next to it, press F1 before continuing.

System Information
Computer:      MS-DOS System with APM
Display:      Cyber932 8 x6 256 small font
Mouse:        Microsoft, or IBM PS/2
```

- Press **Enter** to install APM.
- Restart the system to make APM effective.

Decreasing LCD Brightness

Adjust the brightness control on the LCD to the lowest level possible that allows you to comfortably view the screen. This is an effective way of conserving battery power.

Using the Battery Power-Management Function

Note:
When you install an operating system, you must install the ThinkPad Features program using the Utility Diskette.

To install the ThinkPad Features program:



Chapter 7.

Your computer has the following built-in battery power-saving functions to save power when you use the battery pack or AC Adapter:

Operation modes. The operation modes control the processor speed or set timers for saving power. For more information about the operation modes, see 2 on page 35.

Power-saving modes. The power-saving modes stop all tasks when the computer is not used for a specified time.

When resuming normal operation from one of the modes, use the **resume function** to return to where you were when you entered that mode. Because the operating system is already loaded, the resume function is faster than turning on the power.

The following are the three power-saving modes:

Standby mode You can enter standby mode for short idle times, such as when you are taking a short break from work.

Suspend mode You can enter suspend mode for somewhat longer times when you are away from your computer.

Hibernation mode
You can enter hibernation mode when you leave your office for the day.

It takes more time to return to normal operation from suspend mode than to return from standby mode, but the computer does not use as much power.

Using Power Management

The following figure shows the operations required when the computer moves from a power-off condition to operation mode, and vice versa. The battery shows the amount of battery power used in each stage.

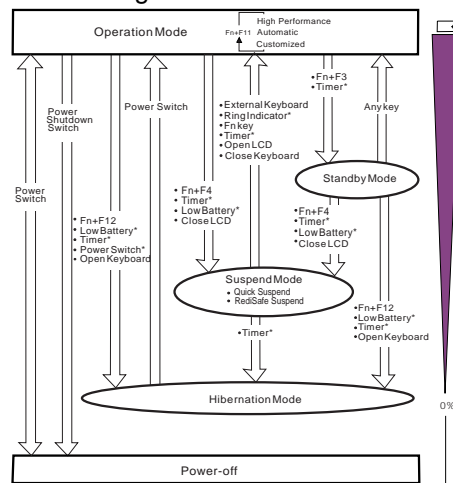

* These options are set using the ThinkPad Features program.

Using Power Management

Standby Mode



In standby mode, the hard disk drive stops and the LCD turns off. The computer immediately resumes normal operation when you press any key or use any pointing device. Also, if a power-saving monitor (Energy Star monitor) is in use when the computer enters standby mode, the computer activates the monitor's low-power mode.

Suspend Modes

The computer provides the following two types of suspend modes for you to save power:

- Suspend mode
- RediSafe suspend mode

The following indicator lamps (visible when the LCD is closed) change status when using suspend mode or RediSafe suspend mode:

Current Status	Indicator Lamps	
	 Suspend Mode	 Power-On
In suspend mode	Green	Off
Entering or resuming suspend	Blinking green	Off
Normal operation	Off	Green

Suspend mode. In suspend mode, all tasks are stopped and stored in memory to save power. When the computer resumes normal operation, the tasks are automatically restored.

RediSafe suspend mode. In this mode, all tasks are stopped, and memory data and the status of the computer are stored on the hard disk drive. This prevents accidental loss of data during suspend mode. Resuming normal operation is faster in RediSafe suspend mode than it is in hibernation mode; the computer resumes normal operation when you press the **Fn** key while in RediSafe suspend mode.

If all battery power is used and the computer turns off during RediSafe suspend mode, install a fully charged battery pack or connect the AC Adapter; then press the power switch to resume operation. All tasks are restored. *Create the hibernation file before using this mode.* (See "Creating the Hibernation File" on page 79.)

Using Power Management



Note:

You can create a hibernation file on the hard disk drive in the main hard disk drive bay.





Note:

You can create a hibernation file on the hard disk drive in the main hard disk drive bay.

To enable RediSafe suspend mode, do the following:

If you are using OS/2 or Windows:

1. Start the ThinkPad Features program.
2. Click on the **Battery**  icon; then click on the **Suspend/Hibernation/Resume options**  icon.
3. If a hibernation file has not been created, click on **Enable hibernation and create the file on the hard disk drive**.
4. Click on the check box next to **RediSafe suspend**. (A mark appears in the check box when RediSafe suspend is selected.)
5. Click on the **OK** button.

If you are using DOS:

1. Type `PS2 HFILE C` at the command prompt; then press **Enter** to create the hibernation file on drive C (type the drive letter of your choice).
2. Type `PS2 SA E` at the command prompt; then press **Enter** to enable suspend mode.

Points to Consider for Suspend Mode

Consider the following before using suspend mode:

The computer can enter suspend mode when used with the following operating systems:

- DOS Version 7.0
- OS/2 Warp Version 3
- Microsoft Windows 3.11 with DOS Version 7.0
- Microsoft Windows 95

Important

When you use Windows Version 3.11, ensure that Advanced Power Management (APM) is installed according to the instructions in "Installing Windows 3.11" on page 165.

Attached devices, such as a printer or serial device, stop running when the computer enters suspend mode. When you resume normal operation, the output might differ from what you expect, because the device might be reset or lose its configuration settings.

Sometimes you might want to use the computer with the LCD closed—for example, when an external monitor and keyboard are used. In such a case, turn on the computer with the LCD closed or set the computer to not enter suspend mode when the LCD is closed using the ThinkPad Features program.

When a power-on password is set and the computer resumes normal operation by the ThinkPad Features timer or an incoming call, only a blank screen is displayed. To display a power-on password prompt, press any key or move your pointing device.

Standby mode:



Page 75.

When the computer is powered with ac power and is using one of the following IBM PC Cards, it enters *standby mode*:

- IBM 3270 Emulation Credit Card Adapter
- IBM Token-Ring 16/4 Credit Card Adapter
- IBM Credit Card Adapter for Ethernet
- IBM 5250 Emulation Credit Card Adapter

When other PC Cards are used and the computer enters suspend mode, all application programs stop. Communication also stops for communication PC Cards not listed above. For some PC Cards, power to the PC Cards might also turn off.

Using Power Management

When the computer is powered with battery power, the computer turns power off to the PC Card, and communication stops for communication PC Cards, so the duration of suspend mode is longer.

If communication for a PC Card is not reestablished after resuming normal operation, remove and then reinstall the PC Card before restarting the system or application program. For other kinds of PC Cards, if the PC Card or computer does not operate, restart the application or computer.

When the computer is using one of the following IBM modem cards and detects an incoming call while in suspend mode, the computer automatically resumes normal operation:

- IBM 28.8/14.4 Data/FAX Modem
- IBM PCMCIA Data/FAX Modem
- IBM High Speed PCMCIA Data/FAX Modem
- IBM Microelectronics 2.4/9.6 Data/FAX Modem
- IBM Microelectronics 14.4/14.4 Data/FAX Modem
- IBM Wireless Modem for ARDIS
- IBM Wireless Modem for Mobitex
- IBM Wireless Modem for Cellular/CDPD

While a communication link is active, the computer does not enter suspend mode.

 When you use Windows 95, the Windows 95 generic CD-ROM driver accesses the internal CD-ROM drive every 3 seconds to see if a disc is inserted in the CD-ROM drive. This prevents a ThinkPad 365XD from entering suspend mode by the timer suspend function even if there is no actual system activity for a certain period.

To stop this auto-detect function and enable the timer suspend function, do the following:



1. Open **My Computer**.
2. Open **Control Panel**; then open **System**.
3. Click on the **Device Manager** tab.
4. Click on the + mark of **CD-ROM**.
5. Double-click on **TEAC** CD-40E**.
6. Click on the **Setting** tab.
7. Remove the check mark from **Auto insertion notification**.

Windows 95 will no longer detect CD-ROM insertion automatically.

Note:

You must set the **Resume on incoming call** option in the ThinkPad Features program so the computer automatically resumes normal operation.

For OS/2 or Windows:

1. Click on the **Battery** () icon.
2. Click on the **Suspend/Hibernation/Resume option** () icon; then select the **Resume on incoming call** option.

For DOS: Enter PS2 RI E

Notes:

1. Before using hibernation mode, you must create a hibernation file.
2. Using an expansion unit or a particular PC Card can disable the hibernation mode.
3. With a base memory of 8MB, it takes approximately 10 seconds to enter hibernation mode and 18 seconds to resume normal operation. (The time to enter or exit hibernation mode depends on the computer memory size.)

Hibernation Mode

In hibernation mode, all tasks are stopped and memory data and the current status of the computer are stored on the hard disk drive; *then power is turned off*. No battery power is used. When power is turned on again, the computer automatically restores the tasks and resumes normal operation. When the computer enters hibernation mode, you hear one short beep. A graphical message appears and the suspend mode indicator lamp blinks; then a short beep sounds again to inform you that the computer has entered hibernation mode.

Creating the Hibernation File

Attention:

The hibernation file must not be created in a compressed data area of the hard disk.

Note:

You can create a hibernation file on the hard disk drive in the main hard disk drive bay.

When installing an operating system or installing additional computer memory, you must create a hibernation file on the hard disk drive to use the hibernation mode. (You only need to create the hibernation file once after installing an operating system or additional memory.)

The size of the hibernation file will be greater than total memory. For example, if base memory is 8MB and you have installed an optional 8MB memory module (DIMM), the hibernation file is 17MB:



$$(8\text{MB} + 8\text{MB}) + 1\text{MB} = 17\text{MB}$$

The following describes how to create a hibernation file for your operating system.

Using Power Management



If you are using OS/2 or Windows:

- 1** Turn on the computer and start the ThinkPad Features program.
- 2** Click on the **Battery** () icon.
- 3** Click on the **Suspend/Hibernation/Resume options** () icon.
- 4** Click on the **Enable Hibernation** button in the menu.
- 5** Make sure the hard disk drive in the computer is selected; then press the **OK** button to create the hibernation file.

The computer can now enter hibernation mode.



If you are using DOS:

Type `PS2 HFILE C` at the command prompt; then press **Enter**.

The hibernation file is created on drive C.

Points to Consider When Using Hibernation Mode

Consider the following before using hibernation mode:

Do not run any tasks while the hibernation file is being created.

Create the hibernation file only on the hard disk drive installed in the computer. The hibernation file is hidden and cannot be accessed.

The computer uses battery power to enter hibernation mode. Therefore, it reserves some battery power when it is set to enter hibernation mode when a low-battery condition occurs. This can cause the battery operating time to be reduced.

 When you enter hibernation mode while playing music CDs or multisession photo CDs, you will not return to where you left off after resuming normal operation.

When the computer is powered with battery power, the computer turns power off to the PC Card when entering hibernation mode. When resuming normal operation, if the PC Card or computer does not operate, restart the application or computer.

When the computer is powered with ac power and is using one of the following IBM PC Cards, it does not enter hibernation mode:

- IBM 28.8/14.4 Data/FAX Modem
- IBM PCMCIA Data/FAX Modem
- IBM High Speed PCMCIA Data/FAX Modem
- IBM 3270 Emulation Credit Card Adapter
- IBM Token-Ring 16/4 Credit Card Adapter
- IBM Credit Card Adapter for Ethernet
- IBM 5250 Emulation Credit Card Adapter
- IBM Microelectronics 2.4/9.6 Data/FAX Modem
- IBM Microelectronics 14.4/14.4 Data/FAX Modem
- IBM Wireless Modem for ARDIS
- IBM Wireless Modem for Mobitex
- IBM Wireless Modem for Cellular/CDPD

This prevents possible problems from occurring with communication application programs after the computer returns to normal operation.

Note:

You can create a hibernation file on the hard disk drive in the main hard disk drive bay.

Note:

If the communication links are still not reestablished, remove and then reinstall the PC Card before restarting the system or application program.

Using Power Management

The figure shows approximately how much power is normally required for each computer feature, and how much is required when the feature is controlled by the battery power-management function.

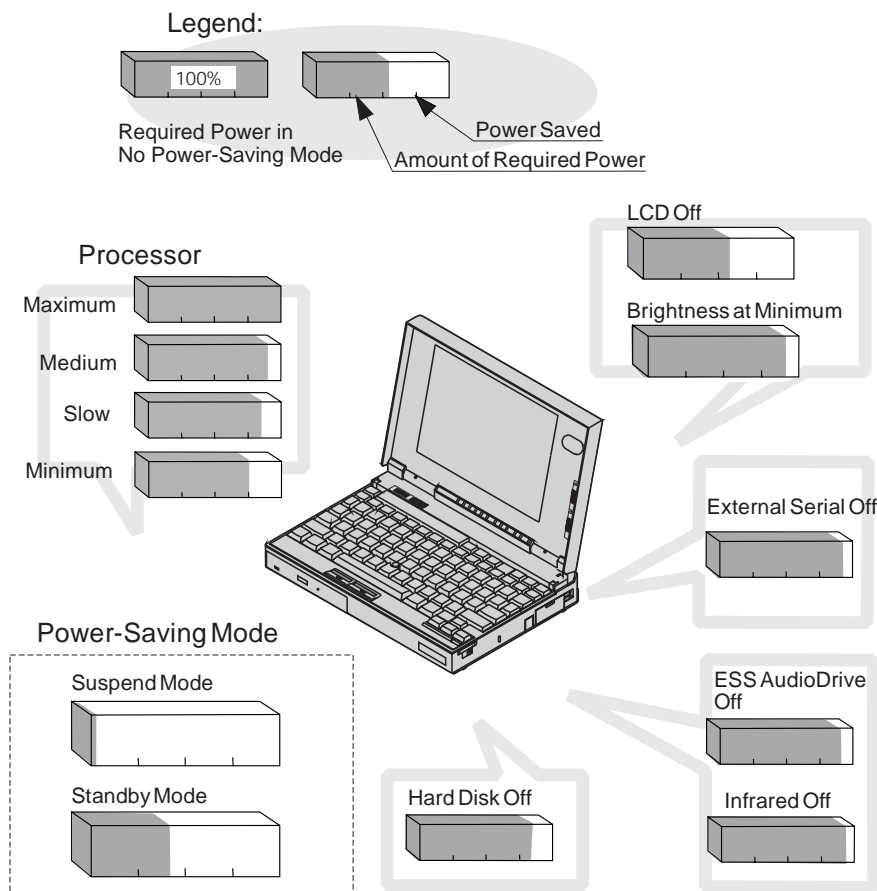

Chapter 5. Protecting Your Computer

This chapter provides information about how to protect your computer and its internal devices.

Using Passwords	84
Power-On Password	84
Setting a Power-On Password	85
Entering a Power-On Password	86
Changing a Power-On Password	87
Removing a Power-On Password	88
Hard Disk Password	89
Setting a Hard Disk Password	90
Entering a Hard Disk Password	91
Changing a Hard Disk Password	92
Removing a Hard Disk Password	93
Supervisor Password	94
Setting a Supervisor Password	94
Entering a Supervisor Password	95
Changing a Supervisor Password	96
Removing a Supervisor Password	97
Using the Personalization Feature	98
Entering the Personal Information	99
Deleting a Personalized Screen	101
Using Locks	102
Using Locking Devices	102
Affixing a Nameplate	103

Using Passwords

Using Passwords

There are three types of passwords you can use to protect your computer and the removable hard disk drive:

The *power-on password* protects your computer from being used by unauthorized persons.

The *hard disk password* protects the data on your removable hard disk drive from being accessed by unauthorized persons.

The *supervisor password* protects the system information in Easy-Setup from being modified and your removable hard disk drive from being used by unauthorized persons.

Hints and Tips

You can display your personal information, such as your name or address, on the password prompt screen. For details, see page 98.

Power-On Password

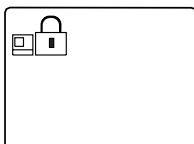

The power-on password helps protect your computer from being used by unauthorized persons. If a power-on password is set, the password prompt (🔒) appears on the screen whenever you turn on the computer and reminds you to enter the password.

Setting a Power-On Password

To set a power-on password:

Note:
If **Initialize** in the Config menu, **Password**, or **Start up** cannot be selected when using Easy-Setup, a supervisor password is set. You must enter the supervisor password instead of the power-on password to use all Easy-Setup functions.

Note:
When you type a wrong key, use the **Backspace** key to erase it and then type the correct key.

- 1** Start Easy-Setup and select the **Password** icon.
To start Easy-Setup, press and hold **F1** and turn on the computer.
- 2** Select the **Power-On** icon (.
- 3** Type your desired power-on password; then press **Enter**.
You can use any combination of up to 7 characters. Use a combination of any letters or numbers (*A* to *Z*, *0* to *9*) in uppercase (*A*) or lowercase (*a*). Uppercase and lowercase letters (for example, *A* and *a*) are treated the same.
- 4** Type your power-on password again to verify it; then press **Enter**.

Do Not Forget Your Power-On Password!

If you forget your power-on password, you cannot reset it. You have to take the computer to an IBM authorized reseller or IBM marketing representative to have the password canceled. Proof of purchase is required, and an additional charge might be required for the service.

Once you set the password, you cannot change or remove it in Easy-Setup; you must change or remove a password at the password prompt screen that appears when you turn on the computer. See “Changing a Power-On Password” on page 87 or “Removing a Power-On Password” on page 88.

Using Passwords

Entering a Power-On Password

Notes:

If the return to normal operation is caused by a preset timer or an incoming call through the modem, the password prompt does not appear. To display a power-on password prompt, press any key or move your pointing device.

To resume from standby mode when the computer is attached to the Dock I or Dock II, you might need to enter the power-on password.

If a power-on password is set, the password prompt reminds you to enter the password when:

Turning on the computer.

Returning to normal operation from suspend mode.

When the password prompt appears at the top left corner on the screen, do the following:

1 Type your power-on password.

Each time you press a key, the symbol  appears.

When typing your password, release each key quickly. If you hold a key down too long, the same letter can be entered repeatedly.

2 Press the **Enter** key.

*When the password is entered correctly, **OK** appears and the computer starts normal operation.*

*When you enter the password incorrectly, **X** appears. Enter the correct password.*

If you fail to enter the correct password after three tries, you must turn the computer off, wait at least 5 seconds, and turn it on to try again.

Changing a Power-On Password

You must change your power-on password at the password prompt screen that appears when you turn on the computer. You cannot change it after normal operation is resumed. To change a power-on password:

Important

Do *not* press **Enter** until you have finished all the steps to change the power-on password.

- 1** Turn off the computer and wait at least 5 seconds; then turn it on.
- 2** When the password prompt () appears, type your *current* power-on password; then press the **Spacebar**.
- 3** Type the *new* password; then press the **Spacebar**.
Use no more than 7 characters.
- 4** Type the *new* password again to verify it; then press **Enter**.

All the steps can be summarized as follows:

Current(space)New(space)New(Enter)

The new password will be available when you turn on the computer the next time.

Do Not Forget Your Power-On Password!

If you forget your power-on password, you cannot reset it. You have to take the computer to an IBM authorized reseller or IBM marketing representative to have the password canceled. Proof of purchase is required, and an additional charge might be required for the service.

Using Passwords

Removing a Power-On Password

You must remove your power-on password at the password prompt that appears when you turn on the computer. You cannot remove it after normal operation is resumed. To remove a power-on password:

- 1** Turn off the computer and wait at least 5 seconds; then turn it on.
- 2** When the password prompt (🔒) appears, type your current password; then press the **Spacebar**.
- 3** Press **Enter**.

The power-on password is removed.

All the steps can be summarized as follows:

Current(space)(Enter)

Hard Disk Password

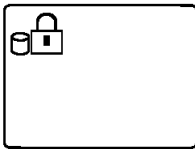

The hard disk password helps you protect the information stored on your removable hard disk drive. Even if your hard disk was removed from the computer, the information stored in your hard disk cannot be accessed without the hard disk password.

Note:

The hard disk password is stored on the hard disk drive when you set the hard disk password, and the power-on password is stored in the nonvolatile memory of the computer.

When you turn on the computer, the hard disk password prompt appears on the screen and reminds you to enter your password.

When a hard disk password is set, a preset timeout or an incoming call will not activate the resume function.

To use the resume function with a hard disk password, set the same password for both the power-on password and the hard disk password.

Note

Using a Hard Disk Password with a Power-On Password:

You can use the hard disk password with the power-on password at the same time. When you turn on the computer, the power-on password prompt appears first, and then the hard disk password prompt appears on the screen. Enter the correct passwords.

When you set the same hard disk password as the power-on password, only the power-on password prompt appears on the screen. Enter the correct password. The hard disk password screen does not appear.

Using Passwords

Setting a Hard Disk Password

Note:
If **Initialize** in the Config menu, **Password**, or **Start up** functions cannot be selected when using Easy-Setup, the supervisor password is set. You must enter the supervisor password instead of the power-on password to use all Easy-Setup functions.

Note:
When you type a wrong key, use the **Backspace** key to erase it, and then type the correct key.

To set a hard disk password:

- 1** Start Easy-Setup; then select the **Password** icon.
To start Easy-Setup, press and hold **F1** and turn on the computer.
- 2** Select **HDD** ().
- 3** Type your desired hard disk password; then press **Enter**.
You can use any combination of up to 7 characters. Use a combination of any letters or numbers (*A* to *Z*, *0* to *9*) in uppercase (*A*) or lowercase (*a*). Uppercase and lowercase letters (for example, *A* and *a*) are treated the same.
- 4** Type your hard disk password again to verify it; then press **Enter**.

Do Not Forget Your Hard Disk Password!

Note the password and keep it in a safe place.

If you forget your hard disk password, there is ***no way to reset your password or recover data from the hard disk***. Neither an IBM authorized reseller nor IBM marketing representative can make the hard disk drive usable.

Once you set the password, you cannot change or remove it in Easy-Setup; you must change or remove a password at the password prompt screen that appears when you turn on the computer. See “Changing a Hard Disk Password” on page 92 or “Removing a Hard Disk Password” on page 93.

Entering a Hard Disk Password

If a hard disk password is set, the hard disk password prompt appears when:

You turn on the computer.

When the computer returns to normal operation from suspend or hibernation mode.

When the password prompt appears at the top left corner on the screen:

Note:

Do *not* press the **Spacebar** after you enter the password; this action removes the password.

1 Type the hard disk password.

Each time you press a key, the symbol  appears.

When typing your password, release each key quickly. If you hold a key down too long, the same letter can be entered repeatedly.

2 Press **Enter**.

*When the password is entered correctly, **OK** appears and the computer starts normal operation.*

*When you enter the password incorrectly, **X** appears. Enter the correct password.*

If you fail to enter the correct password after three tries, you must turn the computer off, wait at least 5 seconds, and turn it on to try again.

Using Passwords

Changing a Hard Disk Password

The procedure to change a hard disk password depends on whether it is set to the same password as the power-on password.

When the hard disk password is set the same as the power-on password:

- 1** Remove the passwords by following the steps in “Removing a Power-On Password” on page 88.
This operation removes both the hard disk password and the power-on password.
- 2** In Easy-Setup, set a new hard disk password. See the steps on page 90.
- 3** If you need a power-on password, set it in Easy-Setup.

When the hard disk password and the power-on password are different, or the power-on password has not been set:

- 1** Turn off the computer and wait at least 5 seconds; then turn it on.
- 2** If you have set a power-on password, type it; then press **Enter**.
- 3** When the hard disk password prompt () appears, type your *current* hard disk password; then press the **Spacebar**.
- 4** Type the *new* password; then press the **Spacebar**.
Use no more than 7 characters.
- 5** Type the *new* password again to verify it; then press **Enter**.

All the steps can be summarized as follows:

Current(space)New(space)New(Enter)

Do Not Forget Your Hard Disk Password!

Note the password and keep it in a safe place.

If you forget your hard disk password, there is **no way to reset your password or recover data in the hard disk drive.**

Neither an IBM authorized reseller nor IBM marketing representative can make the hard disk drive usable.

Removing a Hard Disk Password

The procedure to remove a hard disk password depends on whether or not it is set to the same password as the power-on password.

When the hard disk password is set the same as the power-on password:

- 1** Remove the password by following the steps in “Removing a Power-On Password” on page 88.

This operation removes both the hard disk password and the power-on password.

- 2** If you need a power-on password, reset it in Easy-Setup.

When the hard disk password and the power-on password are different, or a power-on password has not been set:

- 1** Turn off the computer and wait at least 5 seconds; then turn it on.
- 2** If you have set the power-on password, type it; then press **Enter**.
- 3** When the hard disk password prompt (🔒) appears, type your current password; then press the **Spacebar**.
- 4** Press **Enter**.

These steps can be summarized as follows:

Current(space)(Enter)

Using Passwords

Supervisor Password

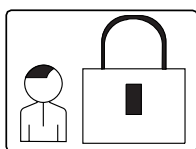

Note:

The supervisor password has priority over the power-on password. You can start the computer with the supervisor password even if you do not know the power-on password.

The supervisor password helps you protect classified information. A supervisor password:

- Secures the system information stored in Easy-Setup.

- Prohibits modification to the hardware.

- Stops the computer after a POST error to restrict access to the system information.

- Overrides the power-on password. (The supervisor password has priority over the power-on password.)

If a supervisor password is set, you are prompted with a **power-on** icon (🔒) to enter the supervisor password when entering the Easy-Setup program and when a POST error occurs. You can start all normal operations for the computer except Easy-Setup without the supervisor password.

Using Both Supervisor and Hard Disk Passwords

When a supervisor password is set, the same password is automatically set for the hard disk password.

When you change or remove the supervisor password, the hard disk password also is changed or removed.

Setting a Supervisor Password

To set a supervisor password:

- 1** Start Easy-Setup; then select the **Password** icon.

To start Easy-Setup, press and hold **F1** and turn on the computer.

- 2** Select the **Supervisor** icon (🔒).

- 3** Type your desired supervisor password; then press **Enter**.

You can use any combination of up to 7 characters. Use a combination of any letters or numbers (*A* to *Z*, *0* to *9*) in uppercase (*A*) or lowercase (*a*). Uppercase and lowercase letters (for example, *A* and *a*) are treated the same.

- 4** Type your supervisor password again to verify it; then press **Enter**.

Do Not Forget Your Supervisor Password!

Note the password and keep it in a safe place.

If you forget your supervisor password, there is ***no way to reset your password or recover data from the hard disk***. You have to take the computer to an IBM authorized reseller or IBM marketing representative to have the system board replaced. Proof of purchase is required, and an additional charge might be required for the service. Neither an IBM authorized reseller nor IBM marketing representative can make the hard disk drive usable.

Entering a Supervisor Password

To enter your supervisor password:

- 1** Type your supervisor password.

Each time you press a key, the symbol appears.

When typing your password, release each key quickly. If you hold a key down too long, the same letter can be entered repeatedly.

- 2** Press **Enter**.

*When the password is entered correctly, **OK** appears.*

*When you enter the password incorrectly, **X** appears.*
Enter the correct password.

If you fail to enter the correct password after three tries, you must turn the computer off, wait at least 5 seconds, and turn it on to try again.

Using Passwords

Changing a Supervisor Password

To change your supervisor password:

- 1** Turn off the computer and wait at least 5 seconds; then turn it on.
- 2** Start Easy-Setup.
To start Easy-Setup, press and hold **F1** and turn on the computer.
- 3** Type your *current* supervisor password at the power-on prompt (🔒); then press **Enter**.
- 4** Select the **Password** icon from the Easy-Setup menu.
- 5** Select the **Supervisor** icon; then type your *current* supervisor password and press the **Spacebar**.
A window appears so you can enter a new password.
- 6** Type the *new* password; then press **Enter**.
- 7** Type the *new* password again for verification; then press **Enter**.

Do Not Forget Your Supervisor Password!

Note the password and keep it in a safe place.

If you forget your supervisor password, you have to take the computer to an IBM authorized reseller or IBM marketing representative to have the system board replaced. Proof of purchase is required, and an additional charge might be required for the service.

If you forget your supervisor password, there is **no way to reset your password or recover data from the hard disk**. Neither an IBM authorized reseller nor IBM marketing representative can make the hard disk drive usable.

Removing a Supervisor Password

To remove the supervisor password:

- 1** Turn off the computer and wait at least 5 seconds; then turn it on.
- 2** Start Easy-Setup.
To start Easy-Setup, press and hold **F1** and turn on the computer.
- 3** When the power-on prompt (🔒) appears, type your current supervisor password; then press **Enter**.
- 4** Select the **Password** icon from the Easy-Setup menu.
- 5** Select the **Supervisor** icon; then type your current password and press the **Spacebar**.
- 6** Press **Enter** at the blank box.
- 7** Press **Enter** again at the verification screen.

When the supervisor password is removed, the lock in the **Supervisor** icon is unlocked (🔓) and you can select the **HDD** icon.

Using the Personalization Feature

Using the Personalization Feature



To set the password:



Page 84.

You can display personal information, such as your name or address, every time the computer is turned on and a power-on or hard disk password is set. This can help you when you misplace your computer. Because the password is set, your data is secured and cannot be accessed, but your personal information is displayed and identifies the owner of the computer.

The personalization feature includes a personalization editor program to create your own image to be displayed with the text information you create, and a personalization update utility to store your personal data in the nonvolatile memory of your system.

The personalized password screen consists of two parts: the personal data area and the background bitmap area.

The *personal data area* 1 is the box in the center of the screen that has a black-and-white bitmap.

The *background bitmap area* 2 surrounds the personal data area.

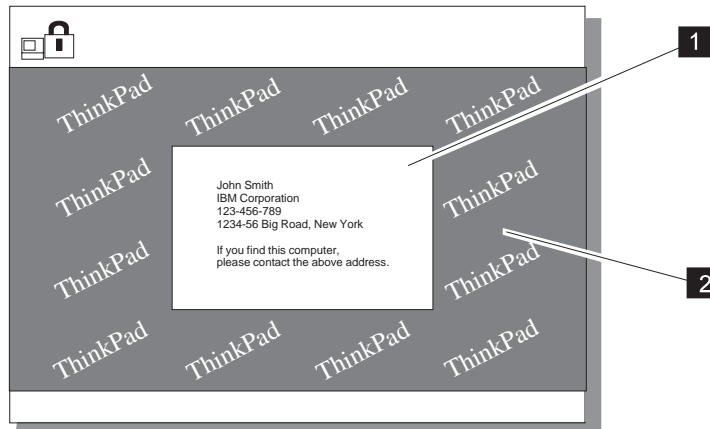

Once you have created and saved this screen, it appears each time the computer is turned on. You must then enter your password.

Entering the Personal Information



To enter personal information for the password screen:

- 1** Turn on the computer and start OS/2 or Windows.
- 2** Make a backup copy of Utility Diskette 2 using your operating system's diskcopy command.
- 3** Insert the backup copy of the Utility Diskette 2 into the diskette drive.
- 4** Start the ThinkPad Features program by double-clicking the **ThinkPad** icon on the screen.
- 5** Click on the **Personalization Editor** () icon.

The personalization editor window appears.

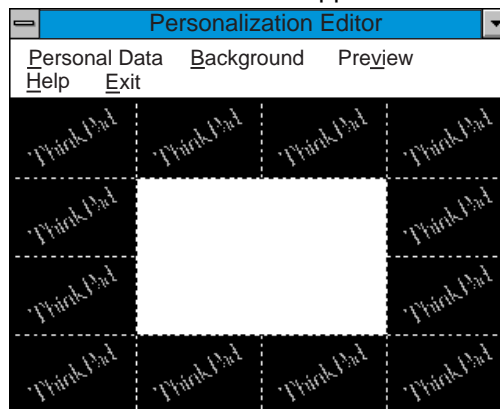

Notes:

Use the **TAB** key to move the cursor to the next field.

You can change the color of the text background from black to white using the **Black background** option.

- 6** Select **Personal Data**.
- 7** Fill in each field with your own information at the Personal Data Entry window.
- 8** Select **OK**.

Next, create the background bitmap as follows:

- 9** Select **Background** in the Personalization Editor window. Windows Paintbrush automatically opens.

Using the Personalization Feature

Note:

A sample bitmap file (BACKSAMP.BMP) is available on Utility Diskette 2.

- 10** Draw an image or color the background.
Your bitmap size must be *160 by 100 pels*. To set the size, select **Options** and then **Image Attributes**. Specify a **Width** of 160, a **Height** of 100, and set the **Units** to pels.
 - 11** Select **File** and **Save As** to save your drawing as a *16-color bitmap* file on the backup copy of Utility Diskette 2. Give your file a name when you save it.
 - 12** Close Paintbrush.
 - 13** When the opening file window appears, enter the name of your bitmap file that you saved on Utility Diskette 2.
 - 14** Select **Preview** to preview the actual full-screen size of the personal information screen.
To return to the previous screen, press **Enter**.
- To save your personalized screen in the nonvolatile memory in the computer:
- 15** Close all applications; then turn off the computer.
 - 16** Insert the backup copy of the Utility Diskette 2 into the diskette drive; then turn on the computer.
 - 17** Select **Update personalization data** at the menu screen; then follow the instructions on the screen.
Your data will be copied from Utility Diskette 2 and stored in the nonvolatile memory in the computer.
 - 18** After the data is stored, turn off the computer.
 - 19** Set your password if you have not yet set it.

To set the password:



Page 84.

You have created your own personalized password screen. It will appear each time the computer is turned on.

Deleting a Personalized Screen

To delete a personalized screen from the password screen:

- 1** Close all applications; then turn off the computer.
- 2** Insert the backup copy of the Utility Diskette 2 into the diskette drive; then turn on the computer.
- 3** Select **Delete personalization data** from the menu; then follow the instructions on the screen.
- 4** After the data is updated, turn off the computer.
Your data has been deleted from the nonvolatile memory in the computer.

Using Locks

Using Locks

Note:

You are responsible for the evaluation, selection, and implementation for the locking devices and security features. IBM makes no comments, judgments, or warranties about the functions, quality, or performance regarding locking devices and security features.

You can protect your computer by attaching locks or a chain, so it cannot be removed without your permission. You can use a lock, such as a Kensington lock, to protect your computer from being removed and also protect the internal devices under the keyboard by locking the keyboard to prevent it from being opened.

Using Locking Devices

To protect the internal devices under the keyboard and prevent the removal of your computer, you can purchase a Kensington lock or a compatible lock. Attach the lock to the keyhole on the side of the computer; then secure the chain on the lock to a stationary object.

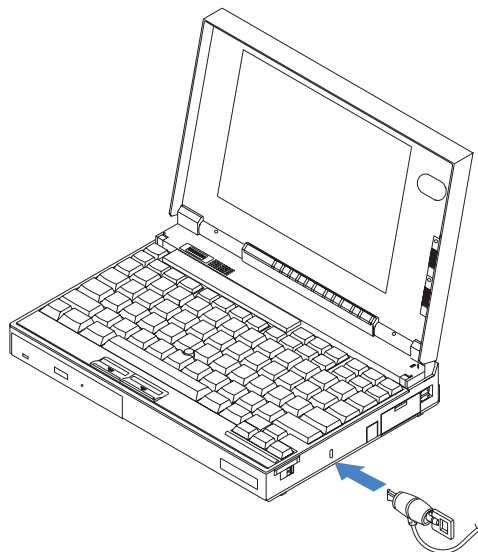

This also prevents the removal of:

- Internal devices under the keyboard
- Any memory module (DIMM) in the memory slot inside the computer.

Affixing a Nameplate

On the front of the ThinkPad, space is provided for a metal nameplate that can be custom engraved with any name, initials, or company name up to 20 characters in length. Among the various materials packaged with your computer, you will find a nameplate brochure card. To receive your nameplate, simply fill out this card and send it in. In a few weeks, the engraved nameplate will be delivered to you.

To affix the nameplate to your ThinkPad, peel off the paper backing to expose the adhesive layer, and press the nameplate firmly into place on the ThinkPad's front panel.

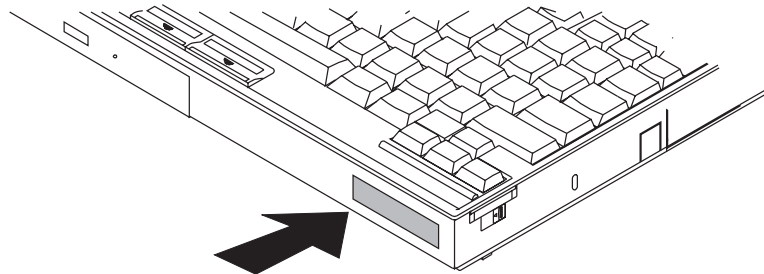

Affixing a Nameplate

Chapter 6. Installing and Removing Options

This chapter provides information on how to install or remove external or internal devices and IBM options.

Note

For instructions on installing and removing the battery pack, see page 65.

Upgrading the Hard Disk Drive	106
Upgrading a ThinkPad 365XD with an Internal CD-ROM Drive	106
Upgrading a ThinkPad 365X with an Internal Diskette Drive	111
Installing PC Cards	115
Removing PC Cards	118
Increasing Memory Capacity	119
Installing a DIMM	119
Removing a DIMM	123
Attaching an External Numeric Keypad or a Mouse	125
Using the Mouse and Other Pointing Devices	126
Attaching an External Keyboard	127
Attaching a Printer	128
IBM ThinkPad 365 Port Replicator	129
Installing the Port Replicator (Option A)	130
Charging the Battery Pack	131
Removing the Port Replicator	132
Installing the Port Replicator (Option B)	133
Inserting or Changing a CD or Floppy Diskette	135
Removing the ThinkPad	136

Upgrading the Hard Disk Drive

Upgrading the Hard Disk Drive

The ThinkPad 365 offers you the option to upgrade your existing hard disk drive to a larger capacity drive. This section contains detailed instructions for removing and installing the hard disk drive.

Upgrading a ThinkPad 365XD with an Internal CD-ROM Drive

To remove the existing hard disk drive from your computer, do the following:

- 1** Turn on the computer.
- 2** Press the CD-ROM eject button to open the CD-ROM tray.
- 3** Turn off the computer.
- 4** Raise the keyboard. Then remove the battery pack.

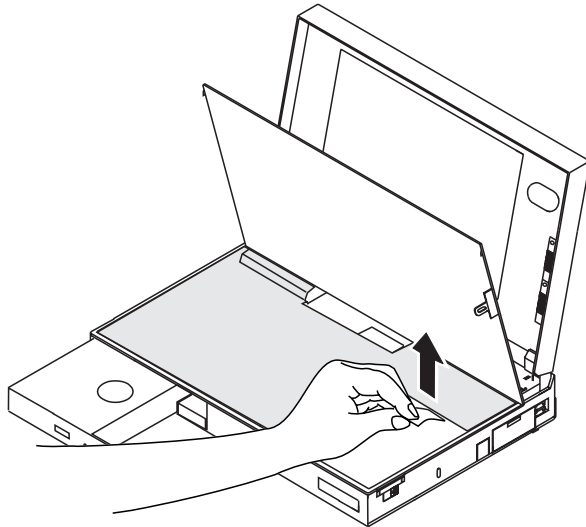

Upgrading the Hard Disk Drive

- 5 Slide your fingers under the right edge of the black insulator sheet, and lift up the adhesive tab. Remove the black insulator sheet completely. (Put the sheet aside. You will reinstall it later.)

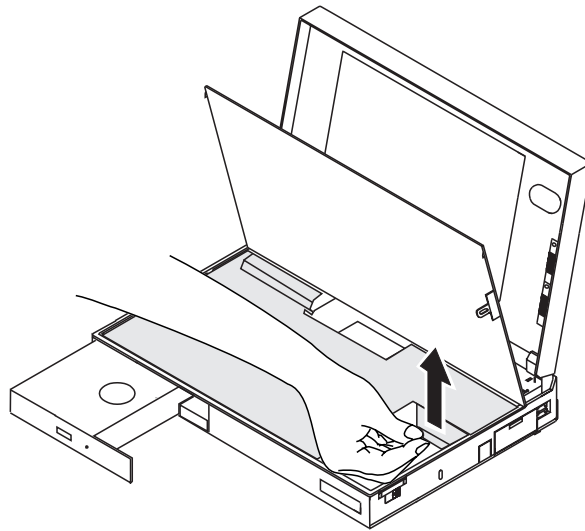

- 6 Remove the screw that holds the hard disk drive in place.

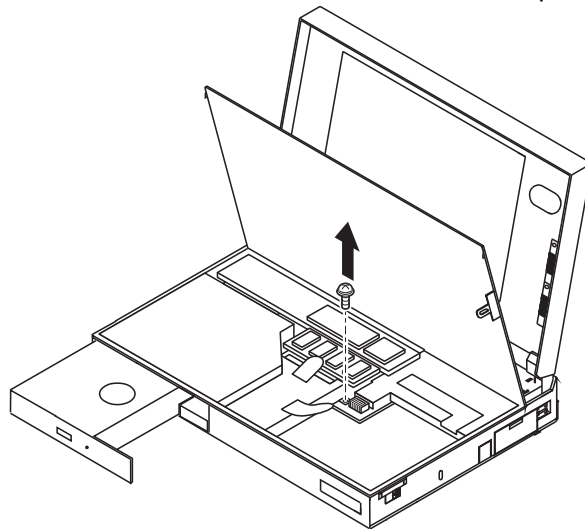

Upgrading the Hard Disk Drive

- 7** Pull the hard disk drive toward the front of the computer, **using the top tab 1**, until the drive is removed from its connector.

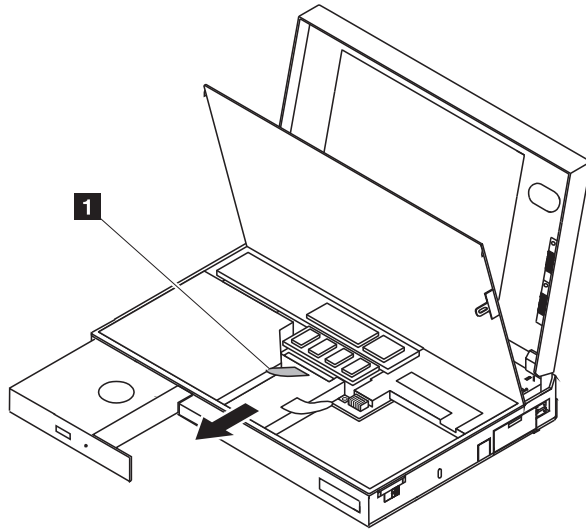

- 8** Lift the drive out of its housing **using the right tab 2**.

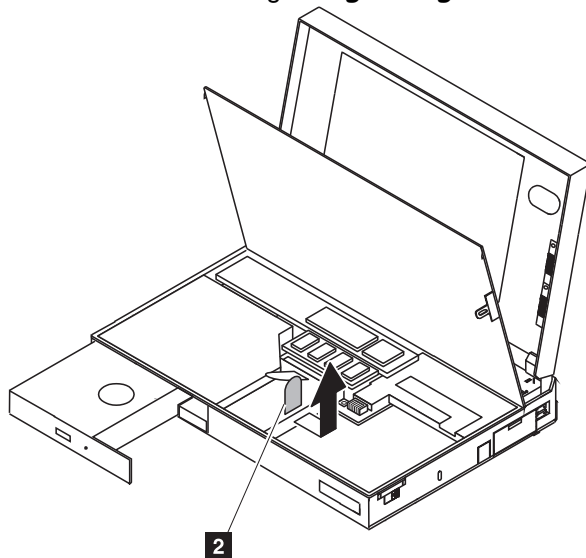

Upgrading the Hard Disk Drive

To install the new hard disk drive, do the following:

- 1** Slide the new drive into position from the right side, under the CD-ROM.
- 2** Push the drive onto the drive connector, while pressing it with your thumb through the opening on the right end of the CD-ROM tray.

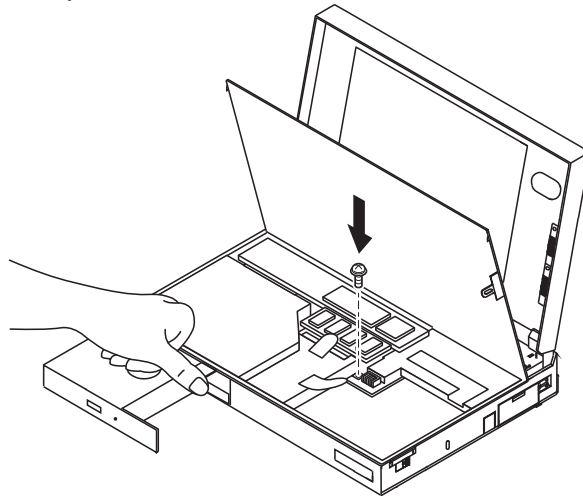

- 3** Reinstall the screw that holds down the hard disk drive.
- 4** Reinstall the black insulator sheet.
- 5** Reinstall the battery pack.
- 6** Lower the keyboard.
- 7** Close the CD-ROM tray.
- 8** Turn on the computer.

Upgrading the Hard Disk Drive

Important!

If the following message appears after you have installed a new hard disk drive, the drive you installed is an *unformatted* drive.

```
xxxxxx KB OK  
I999 3 2
```

(xxxxx is the amount of memory installed in your system.)

Refer to the manual that came with the drive and your operating system manuals to format your drive and install the operating system.

Upgrading a ThinkPad 365X with an Internal Diskette Drive

To remove the existing hard disk drive from your computer, do the following:

- 1** Turn off the computer.
- 2** Raise the keyboard. Then remove the battery pack.

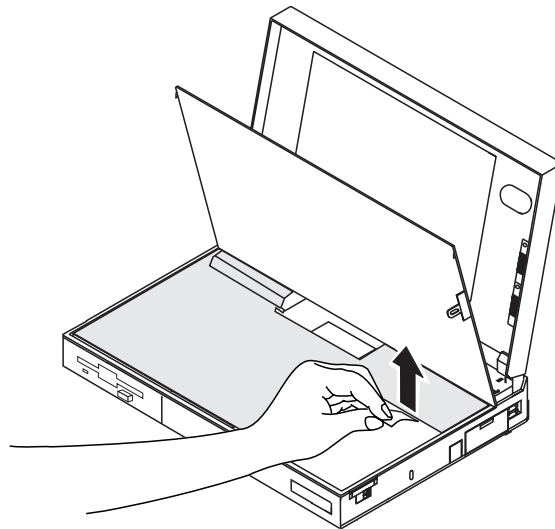

Upgrading the Hard Disk Drive

- 3** Slide your fingers under the right edge of the black insulator sheet, and lift up the adhesive tab. Remove the black insulator sheet completely. (Put the sheet aside. You will reinstall it later.)

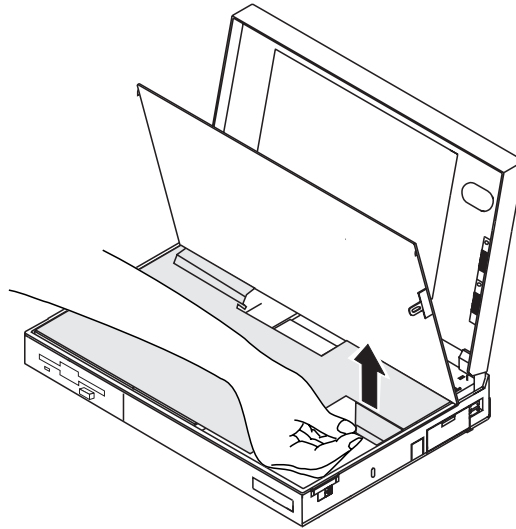

- 4** Remove the screw that holds the hard disk drive in place.

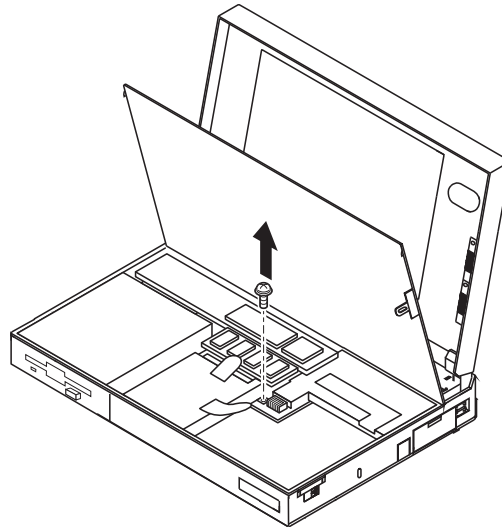

Upgrading the Hard Disk Drive

- 5** Pull the hard disk drive toward the front of the computer, **using the top tab 1**, until the drive is removed from its connector.

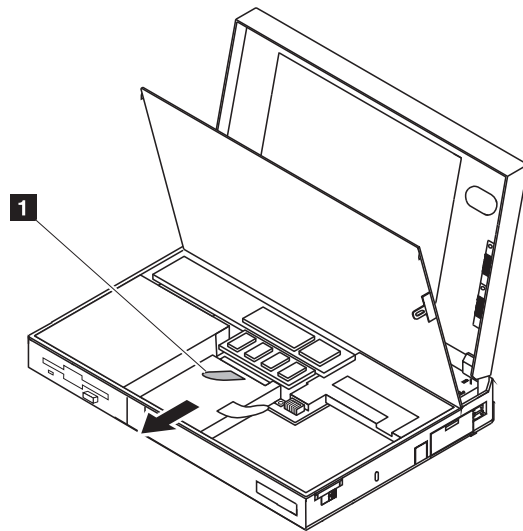

- 6** Lift the drive out of its housing **using the right tab 2**.

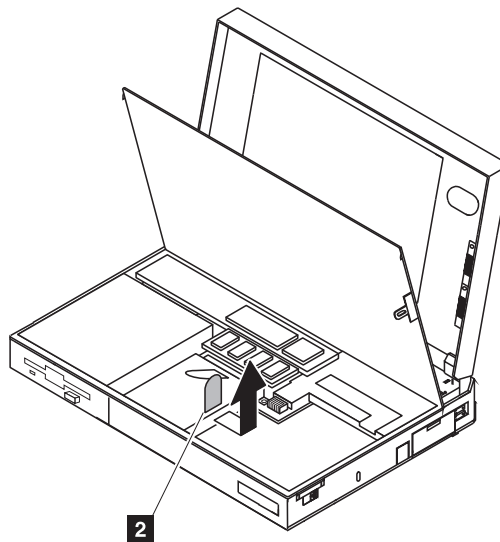

Upgrading the Hard Disk Drive

To install the new hard disk drive, do the following:

- 1** Slide the new drive into position from the right side.
- 2** Push the drive onto the drive connector.
- 3** Reinstall the screw that holds down the hard disk drive.
- 4** Reinstall the black insulator sheet.
- 5** Reinstall the battery pack.
- 6** Lower the keyboard.
- 7** Turn on the computer.

Installing PC Cards

Your computer has two slots that allow you to plug in credit-card-size PCMCIA cards (called PC cards) that support PCMCIA Standard release 2.01 or later.

There are different types of PC Cards. Your ThinkPad 365 supports Type I, Type II, and Type III cards. The PCMCIA slots can be used for the following combinations:

- One or two Type I
- One or two Type II
- One Type I and one Type II
- One Type III

Before Installing PC Cards

Be sure to read "Using PC Cards" on page 49.

For information about the type of PC Cards to install, see Appendix E, "Product Warranties and Notices" on page 269.

To install a PC Card in your computer, follow these steps:

- 1** Open the PCMCIA cover. The cover opens from the top down, like a door. Once opened, the door can then slide into the ThinkPad case where it will be out of the way.

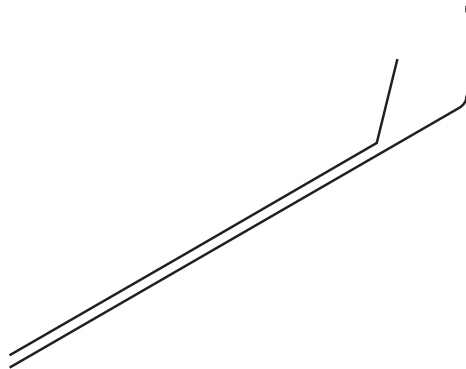

Installing PC Cards

- 2 Insert the PC Card into one of the available slots. There is a gentle click when the PC Card has been fully inserted.

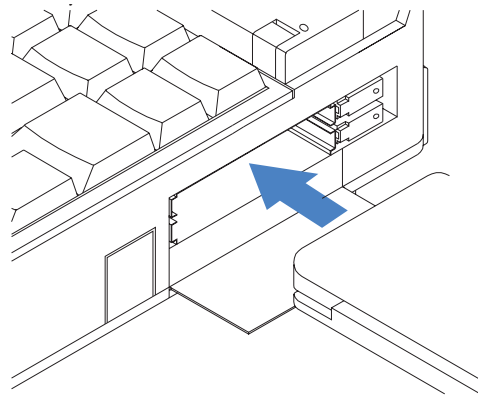

Insert the PC Card with the long row of pin sockets facing the computer and the label on the PC Card facing up. If the PC Card will not fit into the slot, turn the card over. The PC Card can fit into the slot only when inserted the correct way. Do not try to force the card into the slot.

You can insert a Type I or Type II PC Card into either available slot. A Type III PC Card occupies both slots. However, when you insert a Type III card, aim its bottom ridges at the *lower* PC Card slot.

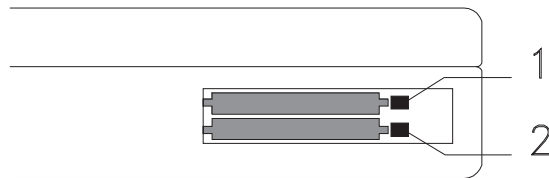

Installing PC Cards

- 3** The PCMCIA slot cover can be slid inside the ThinkPad case where it will be out of the way.

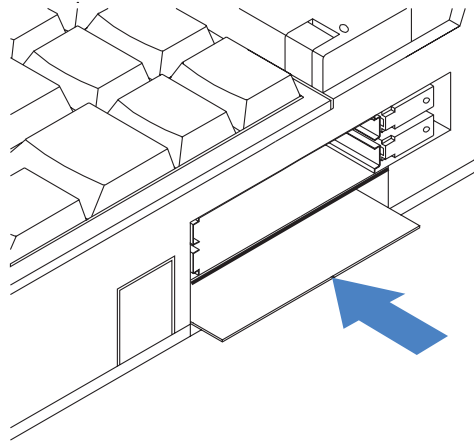

- 4** You can now attach the appropriate devices and cables to your installed PC Card.

To insert an additional Type I or Type II card when one is already installed, follow the same direction, placing the new card into the available slot.

Once you have installed the PC Card, PC Card Director recognizes that a card has been installed and beeps or displays the PC Card Director window on your screen. From the PC Card Director window, you can configure your PC Card by choosing various settings to be used each time you insert any PC Card or use this particular PC Card. For more information about configuring your PC Card, see "Using PC Cards" on page 49.

Removing PC Cards

To remove a PC Card from your computer, follow these steps:

- 1** Detach any devices that are connected to your PC Card. If there are no attached devices and the cover is closed, follow these steps:
 - a** Open the cover of the PC Card slot and slide it into the case.
 - b** Pull out the PC Card release button (if it has been folded into its recessed niche). When it is sticking out straight from the case, press it in gently.

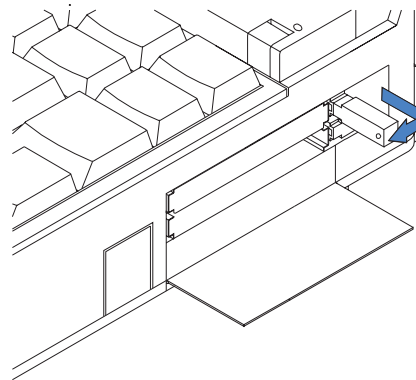

- 2** Carefully slide the PC Card out of the slot.

- 3** Close the cover of the PC Card slots.

After you remove the PC Card, PC Card Director will recognize that the PC Card has been removed and will update the system information accordingly.



If you have installed device drivers in your system, you may want to remove those drivers and update your configuration file (CONFIG.SYS) if you will not be using the same PC Card again.

For more information on altering the CONFIG.SYS file for PC Cards, see “Adding to the CONFIG.SYS File” on page 243.

Increasing Memory Capacity

Increasing memory capacity is an effective way to make programs run faster. You can increase the amount of memory in your computer by installing a memory option, called a *dual inline memory module* or *DIMM*, to increase your computer's memory.

Attention:

To avoid damaging the DIMM, do not touch the contact edge of the DIMM.

Important!

Changing memory while your computer is in suspend mode or hibernation mode may cause permanent damage to the equipment.

Installing a DIMM

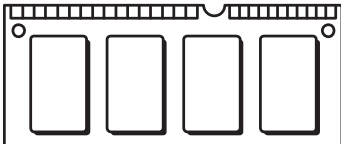

To install the new DIMM, do the following:

- 1** Save any files you are working with.
- 2** Turn the power off.
- 3** Disconnect all cables and other devices, including the AC adapter.
- 4** Open the keyboard. (For instructions, see page 6.)
- 5** Take out the battery pack, if it is installed.

Increasing Memory Capacity

- 6 Slide your fingers under the right edge of the black insulator sheet, and lift up the adhesive tab. Remove the black insulator sheet completely. (Put the sheet aside. You will reinstall it later.)

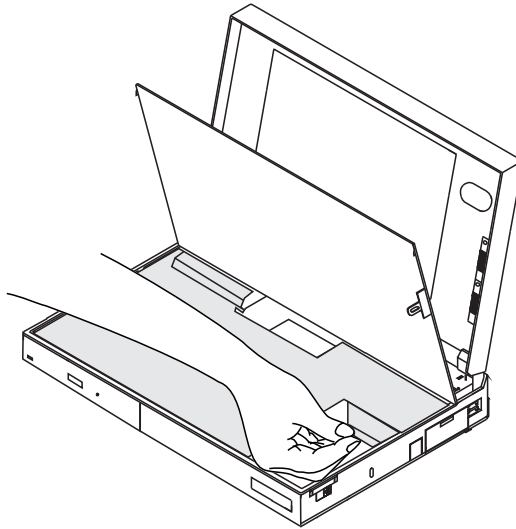

- 7 Locate the DIMM socket 1 .

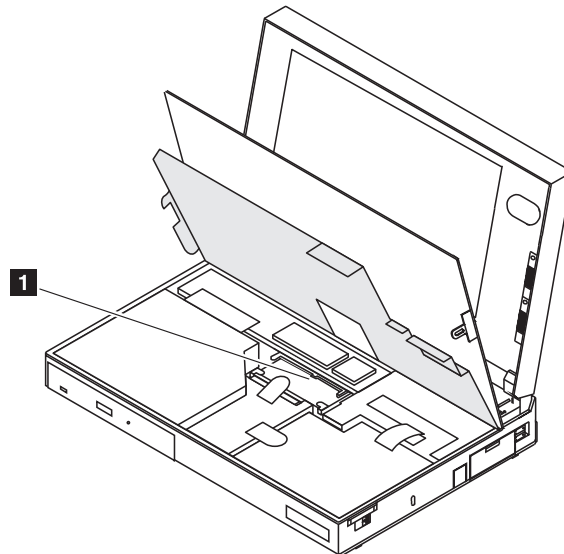

Increasing Memory Capacity

- 8** Hold the DIMM as shown in the illustration, and locate the notch on the DIMM (1).

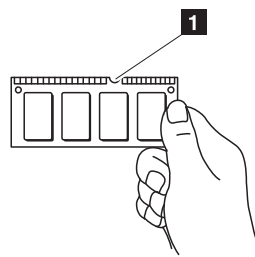

- 9** Position the card at an angle, and push it into the socket firmly, aligning the notch in the slot (1). Then push the module down until it locks into place (2).

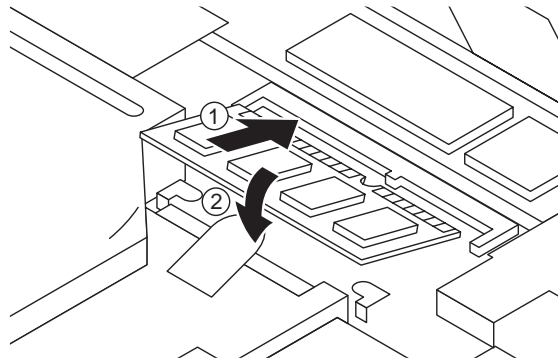

Increasing Memory Capacity

The DIMM should fit into the slot at a slight angle.

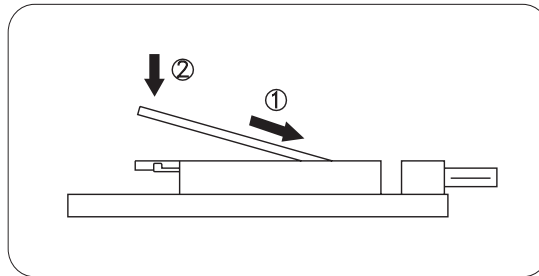

- 10** Replace the black insulator sheet.
- 11** Reinstall the battery pack.
- 12** Close the keyboard.

Removing a DIMM

To remove a DIMM, do the following:

- 1** Save any files you are working with.
- 2** Turn the power off.
- 3** Disconnect all cables and other devices, including the AC adapter.
- 4** Open the keyboard. (For instructions, see page 6.)
- 5** Take out the battery pack, if it is installed.
- 6** Slide your fingers under the right edge of the black insulator sheet, and lift up the adhesive tab. Remove the black insulator sheet completely. (Put the sheet aside. You will reinstall it later.)

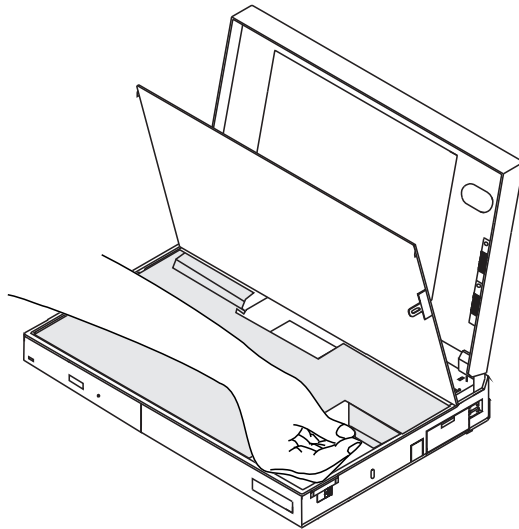

Increasing Memory Capacity

- 7** Locate the latches on either end of the DIMM, and pull them gently apart.

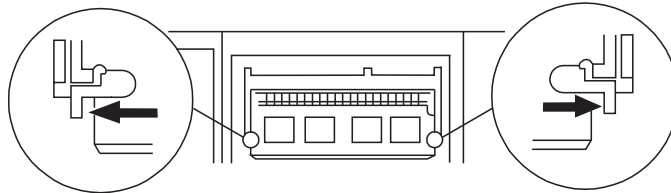

- 8** Lift the DIMM out of its socket.
- 9** Replace the black insulator sheet.
- 10** Reinstall the battery pack.
- 11** Close the keyboard.

Attaching an External Numeric Keypad or a Mouse

Attaching an External Numeric Keypad or a Mouse

Attention:

When you connect a mouse other than an IBM PS/2 Miniature Mouse, turn off the computer.

An external numeric keypad or a mouse can be attached directly to the external input-device connector at the rear of the computer. You can use both the IBM PS/2 Miniature Mouse and TrackPoint III as the pointing device.

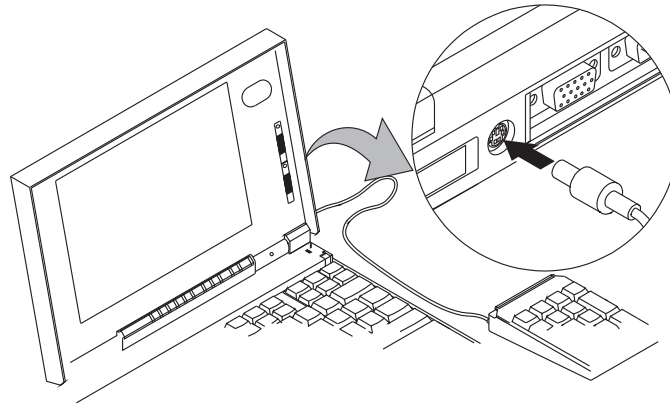
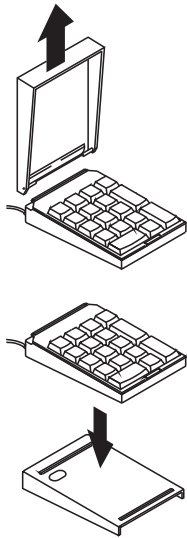

Note:

You can remove the keypad cover and use it as a stand for the keypad.

If you want to use the external numeric keypad and mouse at the same time, first connect the keypad cable to the computer; then connect the mouse cable 1 to the connector at the rear of the keypad.

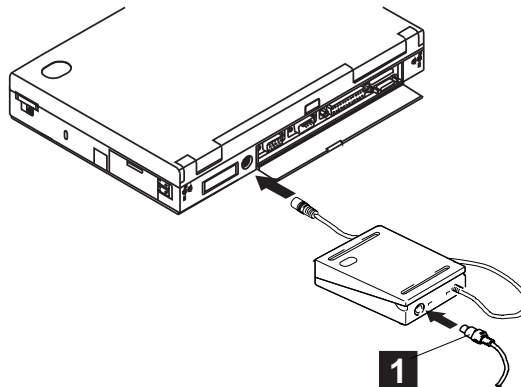

Attaching an External Numeric Keypad or a Mouse

Using the Mouse and Other Pointing Devices

Note:
The appropriate software must already be installed.



A serial mouse connected to the serial port or a device that is not compatible with the IBM PS/2 Miniature Mouse can be connected to the external input-device connector. Some mouse types require the TrackPoint III to be disabled before you can use them. To disable the TrackPoint III:

With OS/2 or Windows:

- 1** Start the ThinkPad Features program.
- 2** Click on the **Keyboard/Pointing-Device** () icon.
- 3** Click on **Disable** for the TrackPoint.

These changes become effective when computer power is turned off and then on again.

Using the IBM ThinkPad Space Saver Keyboard

When using the IBM ThinkPad Space Saver Keyboard, **do not** install the device driver supplied with the Space Saver Keyboard. When the Space Saver Keyboard is used, the device driver on the computer's Utility Diskette automatically enables or disables the TrackPoint III on the computer when power is turned on.

Attaching an External Keyboard

You can connect an external keyboard to your computer through the keyboard/mouse connector 1 (available separately as an option).

Note:

The computer enters suspend mode when the LCD is closed. If you want to use the computer with the LCD closed, set the suspend option in the ThinkPad Features program so the computer does not enter suspend mode when the LCD is closed.

The external keyboard must be connected through the keyboard/mouse connector. It will not work if it is connected directly to the computer.

When the external keyboard is attached, the following keys are not available:

- Numeric keypad on the system keyboard
- External numeric keypad

ThinkPad Features program:



Page 33.

You should use the numeric keypad on the external keyboard.

When you attach the external keyboard, turn off the computer and then attach the keyboard/mouse connector and the external keyboard. (Do ① and ②.)

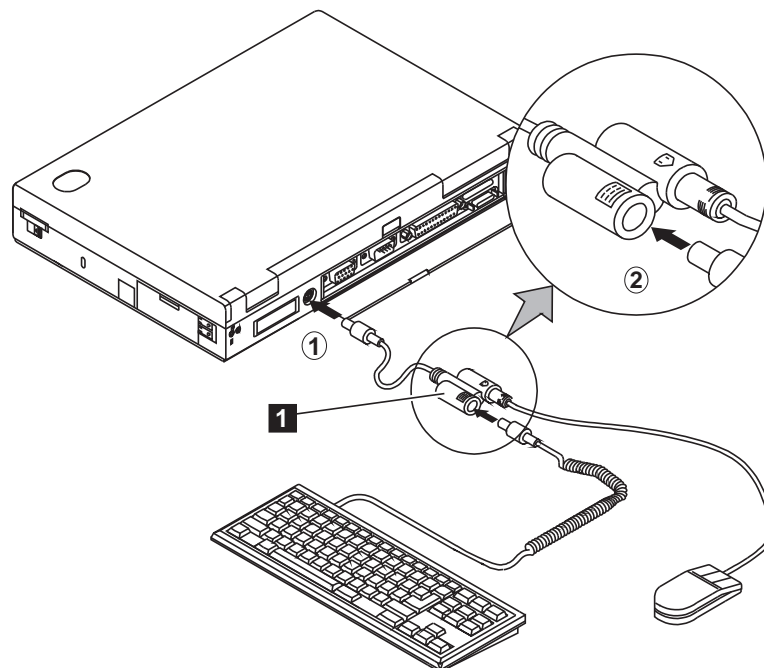

Attaching a Printer

Attaching a Printer

Any parallel printer with the standard Centronics** interface can be attached to the 25-pin, parallel connector at the rear of the computer.

- 1 Turn off the computer and attach the printer as shown.

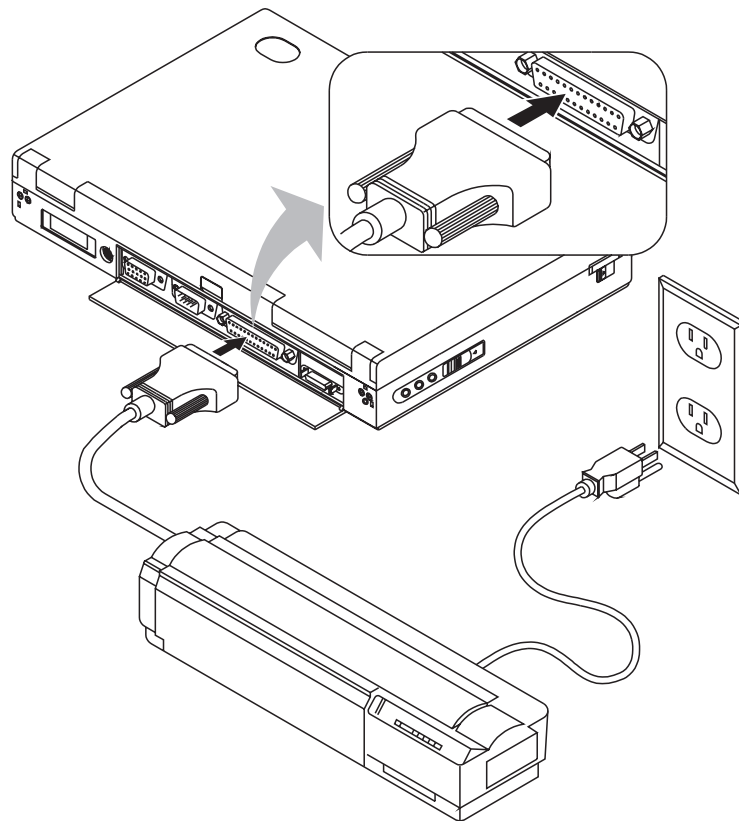

- 2 Turn on the computer and the printer.
- 3 Start the ThinkPad Features program, and click on the Printer icon. Make sure the parallel port is enabled and the address setting (LPT1 or other port) is correct.

Note:
If EPP or ECP is needed, it should also be enabled in the ThinkPad Features program.

IBM ThinkPad 365 Port Replicator

The Port Replicator allows quick and easy access to all of your nonportable peripherals. If you commonly use an external monitor, a printer, a sound system, or some other devices when you are at your desk, you can leave them all connected to the Port Replicator when you are away. When you come back, you only need to install the ThinkPad into the Port Replicator to have immediate access to all of these devices.

- 1 External Monitor Connector
- 2 Serial Connector
- 3 Parallel Connector
- 4 MIDI/Joystick Connector
- 5 Power Jack
- 6 External Diskette Drive Connector
- 7 Line-in Jack
- 8 Line-out/Headphone Jack
- 9 Expansion Connector
- 10 Mouse Connector
- 11 Keyboard Connector

Rear view

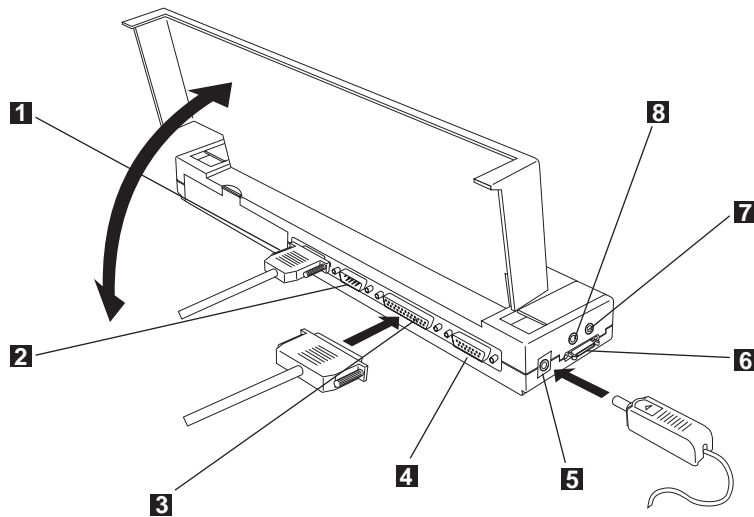

Front view

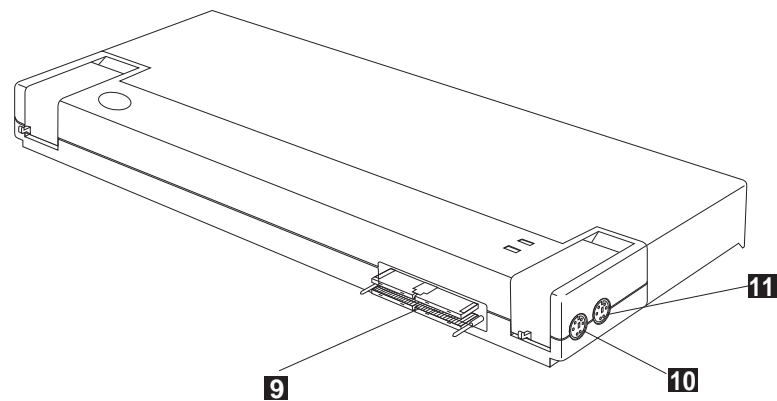

Installing the Port Replicator (Option A)

Before Installing the Port Replicator:

Shut down any applications you are using.

Snap the legs back into the base of the computer, if they are extended.

Turn off the computer and close the display (LCD).

Disconnect the AC Adapter from the electrical outlet first, then from the computer.

Note where each cable of any attached external devices are connected to the computer.

Attach all cables to the connectors on the Port Replicator, including the AC Adapter.

To install the Port Replicator only (without the Desktop Base):

- 1** Remove the Port Replicator Connector cover.
- 2** Place the ThinkPad on a flat surface, such as a desk or table, and place the Port Replicator directly behind it. Align the two, so that the two guide pins on the Port Replicator connectors match up.
- 3** Gently but firmly slide the two together as far as they will go. The Port Replicator is now installed!

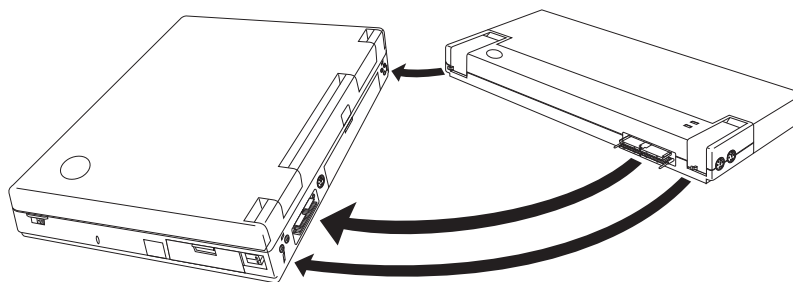

Charging the Battery Pack

The optional Port Replicator can also be used to charge the batteries. To charge a battery pack with the Port Replicator, follow these steps:

Make sure the AC Adapter is plugged into the Port Replicator's power port.

Open the battery compartment door on the back of the Port Replicator.

Note:

The battery pack can be charged through the Port Replicator at any time, regardless of whether the ThinkPad is connected to it. To charge the battery pack using the Port Replicator, be sure to plug the AC Adapter into the Port Replicator.

If the computer is connected to the Port Replicator, the Port Replicator attempts to recharge the battery in the computer first (if one is installed) before going on to charge the battery inserted into the Port Replicator.

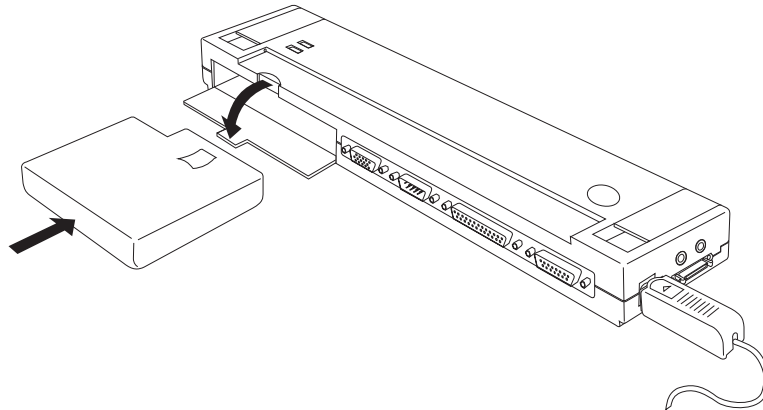

Insert the battery pack into the compartment.

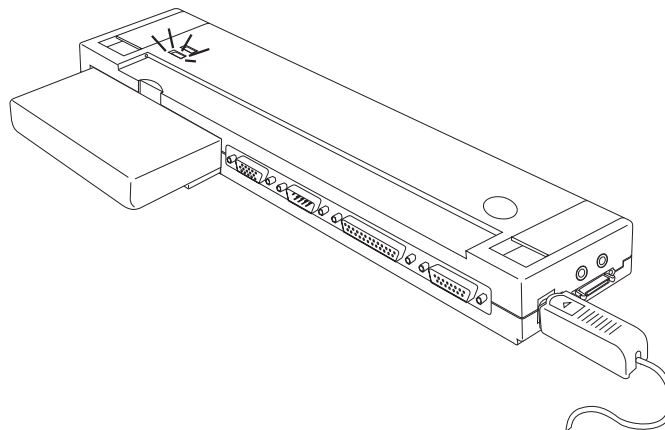

ThinkPad 365 Port Replicator

Removing the Port Replicator

To remove the Port Replicator, locate the two release levers on either end of the replicator. Lift the two levers together, while pressing down with your thumbs on the replicator itself (to keep it from moving). As the levers come up, they will gently and evenly separate the ThinkPad from the replicator.

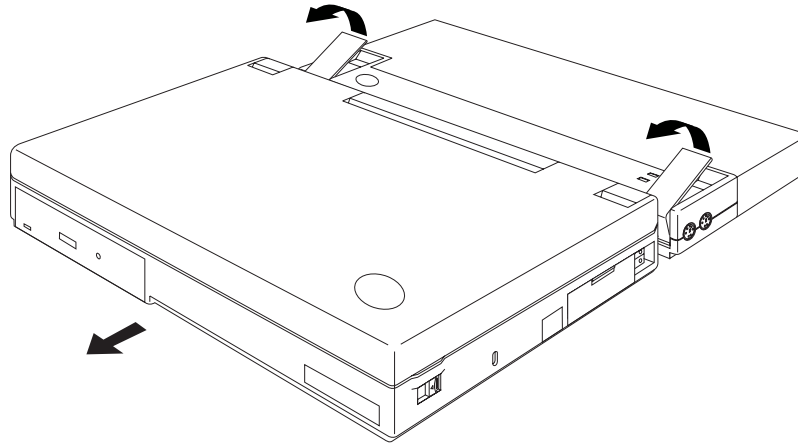

Installing the Port Replicator (Option B)

The Port Replicator's Desktop Base adds an extra level of ease and comfort to your computing. It provides a firm platform on which to work, a palmrest for easier typing, and a cable cover to keep all of your peripheral cables neat and free from dust.

To install the ThinkPad onto the Port Replicator or Desktop Base, follow these steps:

- 1** Slide the palmrest out (away from the Port Replicator), as shown on the next page (①).
- 2** Press the Port Replicator down onto the Desktop Base, making sure that the tabs on the Base line up correctly with the slots in the bottom of the Replicator (②).
- 3** Place the ThinkPad on the Desktop Base, making sure the guide pins on the Port Replicator line up with the corresponding holes in the ThinkPad (③).
Locate the two notches on either side of the Desktop Base, just in front of the palmrest, and grip the base by these notches as you press the ThinkPad into place with your thumbs.
- 4** Finally, push the palmrest back into place (④).

ThinkPad 365 Port Replicator

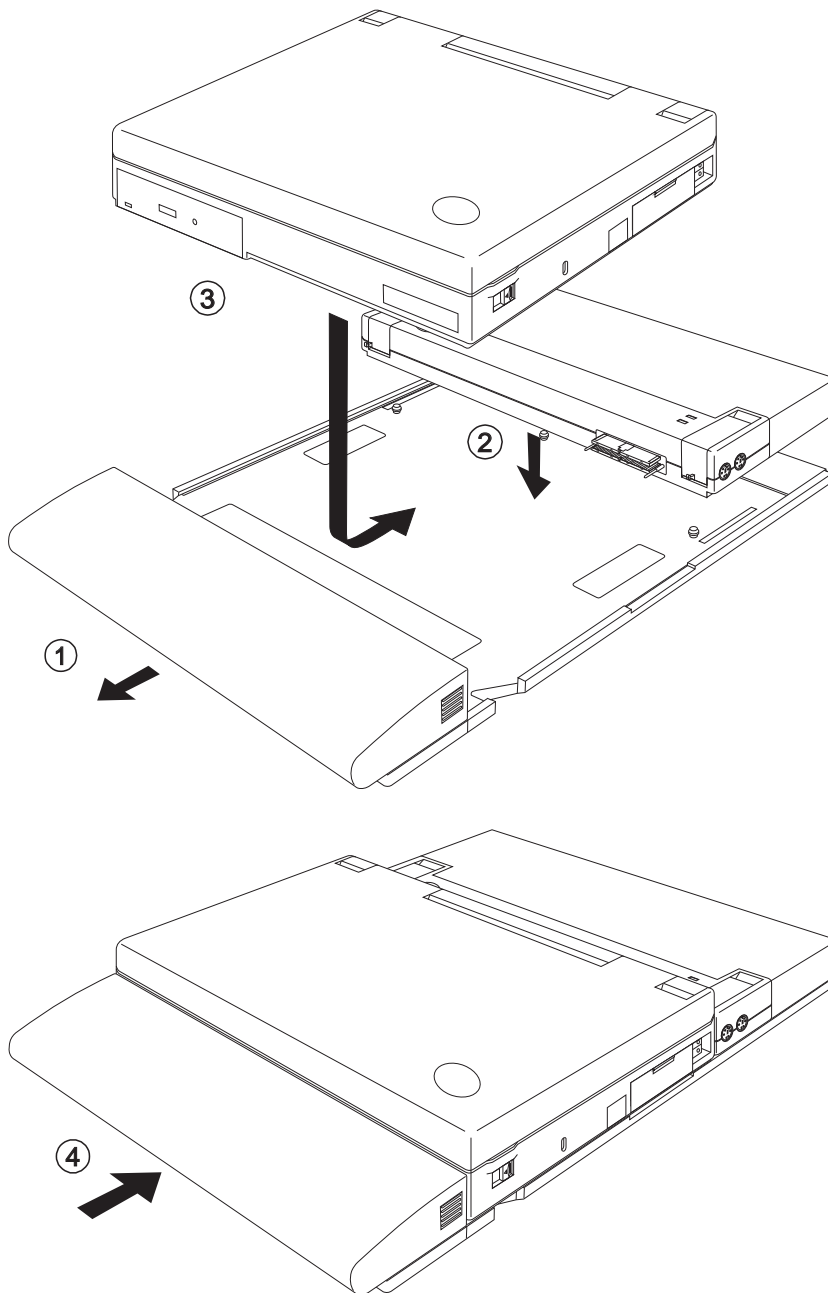

Inserting or Changing a CD or Floppy Diskette

To insert or change a CD or floppy diskette while the ThinkPad is installed in the Desktop Base, pull the palmrest away from the ThinkPad, and lift up the cover as shown.

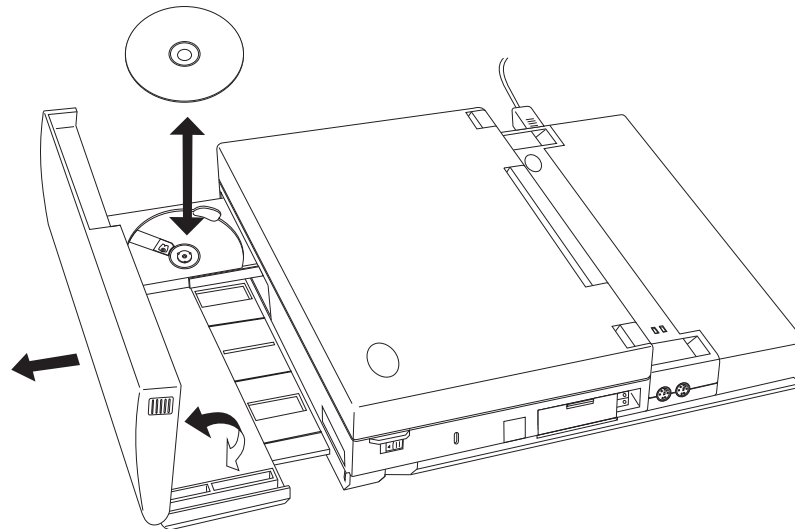

With the CD-ROM drive now exposed, you can insert or change CDs as you would normally. When finished, simply close the palmrest cover and slide the palmrest back into place.

ThinkPad 365 Port Replicator

Removing the ThinkPad

Note:

If you purchased a ThinkPad 365X model with an internal diskette drive, you can use these same instructions for inserting or changing a floppy diskette.

To remove the ThinkPad from the Desktop Base, follow these steps:

- 1** Slide the palmrest out (away from the ThinkPad).
- 2** Locate the two release levers on either end of the replicator. Lift the two levers together, directly behind the ThinkPad, while pressing down with your thumbs on the replicator itself (to keep it from moving). As the levers come up, they will gently and evenly separate the ThinkPad from the replicator.
- 3** Lift the ThinkPad away from the Desktop Base and set it aside.
- 4** Push the palmrest back into place.

Chapter 7. Installing Software

This chapter provides information about the software installed in your computer and the procedures for installing the necessary device drivers when reinstalling an operating system.

What You Need for Your Computer	138
Installing the Operating System and Device Drivers	139
Installing Software for OS/2 Warp	140
Installing IBM OS/2 Warp Version 3	141
Avoiding Video Problems When Installing OS/2 Warp	145
Installing the CD-ROM Device Driver for OS/2 Warp (for the 365XD Only)	147
Installing the ThinkPad Features Program for OS/2 Warp	149
Installing the PCI-IDE Bus Master Driver for OS/2 Warp	150
Installing the PC Card Director for OS/2 Warp	151
Installing the ESS AudioDrive Support Software for OS/2 Warp	152
Installing the AudioDrive Support Software for OS/2	152
Installing the Infrared Device Driver for OS/2 Warp	153
Installing the ThinkPad Display Device Driver for OS/2 Warp	155
Installing Software for DOS	156
Installing IBM PC DOS Version 7.0	157
Installing the CD-ROM Device Driver for DOS (for the 365XD Only)	158
Installing the ThinkPad Features Program for DOS	161
Installing the PC Card Director for DOS	162
Installing Software for Microsoft Windows 3.11	163
Installing Windows 3.11	165
Installing the ThinkPad Features Program for Windows 3.11	169
Installing the PC Card Director for Windows 3.11	170
Installing the AudioDrive Support Software for Windows 3.11	171
Installing the Infrared Device Driver for Windows 3.11	172
Installing the ThinkPad Display Driver for Windows 3.11	173
Installing Software for Microsoft Windows 95	174
Installing Windows 95	175
Installing the ThinkPad Display Driver for Windows 95	177
Installing the ThinkPad Features Program for Windows 95	178
Installing the PCI-IDE Bus Master Driver for Windows 95	179
Installing the PC Card Director for Windows 95	180
Installing the AudioDrive Support Software for Windows 95	184
Installing the Infrared Device Driver for Windows 95	186
Points to Consider When Using Windows 95	187

What You Need for Your Computer

What You Need for Your Computer

Your computer comes with the following software already installed:

- Operating system
- ESS AudioDrive support software
- Infrared device driver
- PC Card Director program
- ThinkPad Features program
- ThinkPad display driver
-  CD-ROM device driver
- Online book

Note:

Before reinstalling the operating system and device drivers, you need to create all installation diskettes using the Diskette Factory (diskette backup program) that is preinstalled on your computer.

When reinstalling an operating system, you must install an operating system and the software listed above for your computer to operate as it did at the time of purchase. The online book, however, is available only at the time of purchase, and no diskettes are available for reinstallation. You should make a backup copy of the online book before beginning the reinstallation process.

The PC Card client device driver is not part of the preinstalled software. Refer to the manual that came with the PC Card to install the device driver.

Note



Some software is shipped on a CD-ROM along with a diskette and might require that the CD-ROM drive and diskette drive be attached to the computer at the same time. If this is the case, use the external-diskette-drive connector to connect the external diskette drive. You can also use the IBM Port Replicator to attach a diskette drive externally. Otherwise, you need to obtain the diskette-only version of your software.

Installing the Operating System and Device Drivers

The operating systems supported by your computer are:

IBM Operating System/2 (OS/2) Warp Version 3
IBM PC DOS Version 7.0
Microsoft Windows 3.11
Microsoft Windows 95

Important

If you will be installing Windows 3.11, you **must** first do the following for Windows to operate correctly:

Install the ThinkPad display driver instead of the default device drivers that came with Windows.

When the Windows Setup program asks you to select either **Express Setup** or **Custom Setup**, select **C** for Custom Setup.

Refer to the appropriate section to install your operating system and its device drivers:



If you are installing OS/2: go to “Installing Software for OS/2 Warp” on page 140.



If you are installing DOS: go to “Installing Software for DOS” on page 156.



If you are installing Windows 3.11: go to “Installing Software for Microsoft Windows 3.11” on page 163.



If you are installing Windows 95: go to “Installing Software for Microsoft Windows 95” on page 174.

Installing Software for OS/2 Warp



This section describes how to install OS/2 Warp in your computer with DOS and Windows. You also need to install the device drivers for OS/2 Warp in your computer.

Important

Before reinstalling the operating system and device drivers, you need to create installation diskettes using the Diskette Factory program (diskette backup program) that is preinstalled on your computer.

Especially, you *must create the Video Graphics Adapter Fix Diskette for OS/2 Warp* to avoid video problems you encounter during installation of OS/2 Warp.

The software shown in the following figure is already installed at the time of purchase. When reinstalling OS/2 Warp Version 3, install this software for your computer to work as it did:

OS/2 Warp Version 3

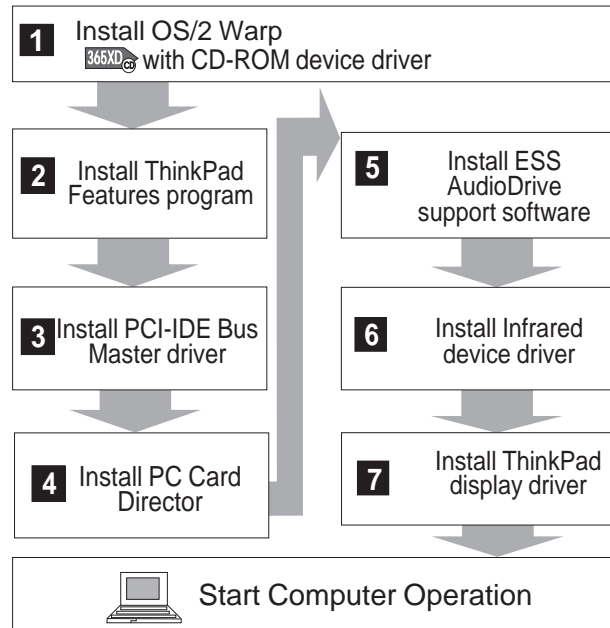

Page numbers:

- 1 Page 141.
- 2 Page 149.
- 3 Page 150.
- 4 Page 151.
- 5 Page 152.
- 6 Page 153.
- 7 Page 155.

Installing IBM OS/2 Warp Version 3

Your installation of OS/2 Warp will differ, depending on whether you use the *Dual Boot* or the *Boot Manager* for switching between OS/2 Warp and DOS/Windows.

Which type are you going to use?

Dual Boot Go to “Installing OS/2 Warp with Dual Boot” on page 142.

Boot Manager Go to “Installing OS/2 Warp with the Boot Manager” on page 143.

Avoiding Video Problems for OS/2 Warp

If you have a video problem when installing OS/2 Warp, go to “Avoiding Video Problems When Installing OS/2 Warp” on page 145 to solve the problem.

Installing IBM OS/2 Warp

To install the DOS ThinkPad Features program:



Page 161.

To install the Windows ThinkPad Features program:



Page 169.

Note:

If you have the OS/2 Warp FixPak 10 (XR0010) or later, install it after you complete the installation of OS/2 Warp. Follow the instructions in the README.1ST file in diskette 1 of that FixPak.

Installing OS/2 Warp with Dual Boot

If DOS and Windows are not installed in the computer, install DOS and Windows, and then install the ThinkPad Features program for both DOS and Windows.

After that, install OS/2 Warp:

To install the diskette version of OS/2 Warp, refer to the documentation. During installation, be sure to pay attention to the following:

- Select **VGA** as the **Primary Display** in the **System Configuration** screen.
- Do not select the **PCMCIA Feature** in the **System Configuration** screen. Leave it as **No Support Installed**.

If you want to continue to install all device drivers, continue with “Installing the ThinkPad Features Program for OS/2 Warp” on page 149.



- If you are using a 365XD and installing the CD-ROM version of OS/2 Warp using the built-in CD-ROM drive, go to “Installing OS/2 Warp Using an External Diskette Drive” on page 144.
- If you are using a 365XD and installing the CD-ROM version of OS/2 Warp using the optional Port Replicator, go to “IBM ThinkPad 365 Port Replicator” on page 129.

Important

You need at least 90MB of free space on the hard disk drive.

Installing OS/2 Warp with the Boot Manager

When you install OS/2 Warp with the Boot Manager:

- 1** Install the Boot Manager, referring to the OS/2 Warp documentation.
- 2** Install DOS and Windows, and the ThinkPad Features programs for both DOS and Windows.
- 3** Install OS/2 Warp:

If you are installing the diskette version of OS/2 Warp, refer to the documentation. During installation, pay attention to the following:

- Select **VGA** as the **Primary Display** at the **System Configuration** screen.
- Do not select the **PCMCIA Feature** at the **System Configuration** screen. Leave it as **No Support Installed**.
-  Select **Non-Listed IDE CD-ROM** for the CD-ROM at the **System Configuration** screen.

After OS/2 has been successfully installed, make sure you restart the computer.



- If you are using a 365XD and installing the CD-ROM version of OS/2 Warp using the built-in CD-ROM drive, go to “Installing OS/2 Warp Using an External Diskette Drive” on page 144.
- If you are using a 365XD and installing the CD-ROM version of OS/2 Warp using the optional Port Replicator, go to “IBM ThinkPad 365 Port Replicator” on page 129.

Important

You need at least 90MB of free space on the hard disk drive.

To install the DOS ThinkPad Features program:



Page 161.

To install the Windows ThinkPad Features program:



Page 169.

Note:

If you have the OS/2 Warp FixPak 10 (XR0010) or later, install it after you complete the installation of OS/2 Warp. Follow the instructions in the README.1ST file in diskette 1 of that FixPak.

Installing IBM OS/2 Warp

Installing OS/2 Warp Using an External Diskette Drive

- 1** Ensure that DOS and Windows are installed in the computer.
- 2** Insert the OS/2 Warp CD-ROM into the CD-ROM drive.
- 3** Open the DOS command prompt and change to the drive for the CD-ROM drive.
- 4** Type `CDINST` and press **Enter**.
Make copies of the OS/2 Warp diskettes labeled "OS/2 Installation Diskette" and "OS/2 Diskette 1."
- 5** Shut down the system and turn off the computer.
- 6** Insert the OS/2 Installation Diskette into the external diskette drive and turn on the computer.
- 7** When you are prompted to insert OS/2 Diskette 1, insert it into the external diskette drive and insert the OS/2 Warp CD-ROM into the CD-ROM drive.
- 8** Follow the instructions on the screen until the installation is complete.

Note:

If you have the OS/2 Warp FixPak 10 (XR0010) or later, install it after you complete the installation of OS/2 Warp. Follow the instructions in the README.1ST file in diskette 1 of that FixPak.

Be sure to pay attention to the following during installation:

Select **VGA** as the **Primary Display** at the **System Configuration** screen.

Do not select the **PCMCIA Feature** at the **System Configuration** screen. Leave it as **No Support Installed**.

Select **Non-Listed IDE CD-ROM** for the CD-ROM at the **System Configuration** screen.

- 9** Shut down OS/2 and restart the system.

If you want to continue to install all device drivers,

 Continue with "Installing the ThinkPad Features Program for OS/2 Warp" on page 149.

 Continue with "Installing the CD-ROM Device Driver for OS/2 Warp (for the 365XD Only)" on page 147.

Avoiding Video Problems When Installing OS/2 Warp

If you have a video problem when installing OS/2 Warp, do the following:

Important

Make sure you create the Video Graphics Adapter Fix Diskette for OS/2 Warp using the Diskette Factory program *before* reinstalling OS/2 Warp. Have the diskette ready when doing the procedures below.

- 1** Make sure you have created the OS/2 Warp Video Fix Diskette using the Diskette Factory program.
- 2** Start installing OS/2 Warp.
- 3** When prompted to remove Diskette 1 and restart the computer, instead insert the OS/2 Installation Diskette and restart the computer.
- 4** Continue the installation, following the instructions on the screen, until the "Welcome" screen appears.
- 5** Press **F3** and go to the command prompt.
- 6** Insert the OS/2 Warp Video Fix Diskette into the diskette drive.
- 7** Type the following command at the command prompt:

```
a:\repvga c
```

where *c* is the drive where OS/2 Warp is installed. The video driver files will be replaced.
- 8** Remove any diskettes from the diskette drive; then restart the computer.
The second half of the Warp installation continues.
- 9** When selecting a video driver, select a VGA display driver.
- 10** When prompted to remove any diskettes and restart the computer, instead insert the OS/2 Installation Diskette and restart the computer.

Installing IBM OS/2 Warp

11 Continue the installation, following the instructions on the screen, until the “Welcome” screen appears.

12 Press **F3** and go to the command prompt.

13 Insert the OS/2 Warp Video Fix Diskette into the diskette drive.

14 Type the following command at the command prompt:

```
a:\repvga c
```

where *c* is the drive where OS/2 Warp is installed. The video driver files will be replaced.

15 Remove any diskettes from the diskette drive; then restart the computer.

16 Install the SVGA (800×600 or more with 256 colors or more) video mode driver using the ThinkPad 760 Video Driver Diskette for OS/2.

Note

When you open System Configuration in Selective Install after the video driver installation, Video Graphics Array [VGA] is shown as the Primary Display (representing the LCD). However, the video driver is correctly installed if you have followed the foregoing procedure.

You have completed the installation of OS/2 Warp and the correct VGA video driver.

To install the video driver:



Page 155.

Installing the CD-ROM Device Driver for OS/2 Warp (for the 365XD Only)

 This section describes the installation of the CD-ROM device driver for OS/2.

Important

If you installed a CD-ROM device driver (**Non-listed IDE CD-ROM** on the System Configuration screen) when installing OS/2 Warp, you need not reinstall the CD-ROM device driver. Continue with “Installing the ThinkPad Features Program for OS/2 Warp” on page 149.

Have the diskettes that came with the OS/2 system ready; then install the CD-ROM device driver for OS/2:

- 1** Start OS/2.
- 2** Open **OS/2 System**, **System Setup**, and **Selective Install**.
- 3** Select the **CD-ROM Device Support** icon.
- 4** Select **Non-listed IDE CD-ROM** and click on **OK**.
- 5** Click on **OK** at the System Configuration screen.
- 6** At the OS/2 Setup and Configuration screen, select **Install**.
- 7** Follow the instructions on the screen.

You have completed the installation of the CD-ROM device driver. If you want to continue to install all device drivers, continue with “Installing the ThinkPad Features Program for OS/2 Warp” on page 149.

Installing the CD-ROM Device Driver for OS/2 Warp

Note:
When the CD-ROM device driver is installed in your computer, OS/2 automatically modifies the CONFIG.SYS file.

Software Parameters in the CONFIG.SYS File

This section explains the parameters in the CONFIG.SYS file for the OS/2 CD-ROM device drivers:

DEVICE=OS2CDROM.DMD [options]

This is the CD-ROM device class driver, where *options* can be:

- [/V]** Displays messages on the LCD during the installation.
- [/Q]** Does not display messages on the LCD during the installation.

BASEDEV=IBMIDECD.FLT [options]

This is the IDE adapter device driver for ATA Packet Interface devices where *options* can be:

- [/V]** Displays messages on the LCD during the installation.

IFS=[drive]:[path]CDFS.IFS [options]

This is the ISO9660/HSG file system for OS/2. All CD data discs are recorded with this file format. *Options* can be:

- [/C:n]** Indicates how many 64KB segments to use for the sector cache. The default is $n=2$, two 64KB segments.
- [/M:n]** Indicates the maximum number of file sectors to be read at a time. The default is $n=8$, 8 sectors.
- [/V]** Displays messages on the LCD during the installation.
- [/Q]** Does not display messages on the LCD during the installation.

Installing the ThinkPad Features Program for OS/2 Warp

Installing the ThinkPad Features Program for OS/2 Warp

Note:

When installing an operating system, you need to install the ThinkPad Features program.

To install the ThinkPad Features program:

- 1** Start OS/2.
- 2** Insert Utility Diskette 2 into the diskette drive.
- 3** Install the ThinkPad System Management device driver:
 - a)** Open **OS/2 System** and then **System Setup**.
 - b)** Select **Device Driver Install**.
 - c)** Click on the **Install...** button.
 - d)** Click on **ThinkPad System Management Device Driver**; then click on **OK**.
- 4** Open the OS/2 screen command prompt.
- 5** Remove Utility Diskette 2 from the diskette drive, and insert Utility Diskette 1.
- 6** Go to the A: prompt and type `INSTALL2`; then press **Enter**. Follow the instructions on the screen.
- 7** Install the Windows ThinkPad Features program for the WIN-OS/2 session:
 - a)** Exit the OS/2 screen; then open the WIN-OS/2 full screen.
 - b)** Follow the instructions in "Installing the ThinkPad Features Program for Windows 3.11" on page 169.
- 8** Install the DOS ThinkPad Features program to use the PS2 commands.
 - a)** Exit the WIN-OS/2 full screen; then open the DOS full screen.
 - b)** Follow the instructions on page 161.

You have completed the installation of the ThinkPad Features program.

If you want to continue to install all device drivers, continue with "Installing the PCI-IDE Bus Master Driver for OS/2 Warp" on page 150.

Installing the PCI-IDE Bus Master Driver for OS/2 Warp

Installing the PCI-IDE Bus Master Driver for OS/2 Warp

Note:

When installing an operating system, you need to install the PCI-IDE Bus Master driver to improve the performance of hard disk drive in the computer.

To install the PCI-IDE Bus Master driver:

- 1** Start OS/2.
- 2** Insert the Utility Diskette 2 into the diskette drive.
- 3** Open the OS/2 command prompt.
- 4** Type `A : INSTPX`; then press **Enter**.
- 5** After the installation is complete, remove any diskette from the diskette drive; then restart OS/2.

You have completed the installation of the PCI-IDE Bus Master driver for OS/2.

If you want to continue to install all device drivers, continue with "Installing the PC Card Director for OS/2 Warp" on page 151.

Installing the PC Card Director for OS/2 Warp

PC Card Director:



Page 50.

When installing an operating system, you need to install the following device drivers and software associated with PCMCIA before you can use the PC Cards:

PC Card device drivers:

- Card Services device driver
- Socket Services device driver
- PC Card Power Management device driver
- PC Card Director utility

PC Card client device drivers (only when PC Card Director does not support the PC Card)

To install the PC Card Director:

- 1** Turn on the computer and start the operating system.
- 2** Insert the diskette labeled "PCMCIA Installation Diskette for OS/2, Windows 95" into the diskette drive.
- 3** Open the OS/2 full screen command prompt.
- 4** Type `A:\PCMINST2` at the OS/2 command prompt; then press **Enter**.
- 5** Follow the instructions on the screen.
- 6** Click on **OK** when you have completed the installation.
- 7** After the installation is complete, close all applications, remove the diskette from the diskette drive, and restart the system.

Note:

Whenever you update the CONFIG.SYS file, refer to "Adding to the CONFIG.SYS File" on page 243.

You have completed the installation of the PC Card Director for OS/2.

If you want to continue to install all device drivers, continue with "Installing the ESS AudioDrive Support Software for OS/2 Warp" on page 152.

Installing the ESS AudioDrive Support Software for OS/2 Warp



Installing the AudioDrive Support Software for OS/2:

The AudioDrive support software for OS/2 is supplied on the AudioDrive Features Diskette or in the hard disk drive of your computer.

When the software is supplied on the hard disk drive

If the AudioDrive Features Diskette was not supplied with your computer, the support software is contained on the hard disk drive. Create the AudioDrive Features Diskette using the diskette backup program (Diskette Factory) that is preinstalled on your computer.

Have ready the AudioDrive Features Diskette; then install the AudioDrive support software as follows:

Note:

To open the OS/2 full screen:

1. Select **OS/2 System**.
2. Select **Command Prompts**;
then select **OS/2 Full Screen**.

- 1** Turn on the computer and start OS/2.
- 2** Open the OS/2 full screen command prompt.
- 3** Insert the AudioDrive Features Diskette for OS/2 into the diskette drive of your computer.
- 4** Type `A:ESUNINST` at the command prompt; then press **Enter**.
Necessary backups are created.
- 5** Type `A:MINSTALL` at the command prompt; then press **Enter**.
- 6** Select **AudioDrive ES1688** from the list.
Make sure the source drive is `A:`.
If you have Win-OS/2 installed on your computer, also select **ES1688 WinOS2/Windows Audio**.
- 7** Click on **Install**; then follow the instructions on the screen.
- 8** When you have completed the installation, shut down OS/2; then restart the computer.

You have completed the installation of the AudioDrive support software for OS/2.

If you want to continue to install all device drivers, continue with "Installing the Infrared Device Driver for OS/2 Warp" on page 153.

Installing the Infrared Device Driver for OS/2 Warp

Installing the Infrared Device Driver for OS/2 Warp

Note:

When installing an operating system, you need to install the infrared device driver.

To install the infrared device driver:

- 1** Turn on the computer and start OS/2.
- 2** If you have not installed DOS and WIN-OS/2 support for OS/2, install it by referring to your operating system manual.
- 3** Go to the DOS command prompt.
- 4** Insert the Infrared Features diskette into the diskette drive.
- 5** Type `A:UINSTALL` and press **Enter**.

The following screen appears:

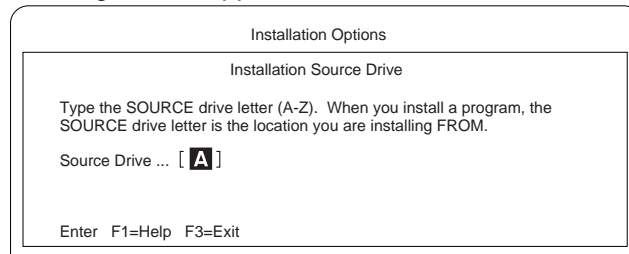

- 6** Press **Enter**; then follow the instructions on the screen.
Select **Install Win-OS2 ThinkPad InfraRed Driver** when you are asked.

You have completed the installation of the infrared device driver.

Installing the Infrared Device Driver for OS/2 Warp

Starting TranXit or Other Infrared Applications

If you are going to start TranXit or any other infrared applications that use the ThinkPad infrared device driver from:

The Program Manager window, do the following:

1. Click on the Program Manager object in the **Windows Programs** folder or the **WIN-OS2** (full screen or window) object in the **Command Prompts** folder with the right mouse button.
2. Select **Settings, Session**, and then **WIN-OS/2 Settings**.
3. Modify the following setting as shown:

COM_DIRECT_ACCESS ON

A separate object that you have created for the infrared application, do the following:

1. Click on the object with the right mouse button.
2. Select **Settings, Session**, and then check **Separate Session**.
3. Select **WIN-OS/2 Settings** and modify the following setting as shown:

COM_DIRECT_ACCESS ON

If you want to continue to install all device drivers, continue with "Installing the ThinkPad Display Device Driver for OS/2 Warp" on page 155.

Installing the ThinkPad Display Device Driver for OS/2 Warp

Installing the ThinkPad Display Device Driver for OS/2 Warp

Note:
When installing an operating system, you need to install the ThinkPad display device driver.

ThinkPad Features:



Page 33.

The display driver enables you to use various screen resolutions and colors for the LCD and external monitor. (See page 45 for possible combinations of resolution and color.) The display driver also takes advantage of the computer's video capability.

Before Installation

Before you begin installing the display driver, set the display device mode to *LCD*: open the ThinkPad Features program and select the **LCD** () icon, or at the command prompt, type `PS2 SC LCD` and press **Enter**.

To install the ThinkPad display device driver:

- 1** Start OS/2.
- 2** Insert the ThinkPad Video Features Diskette for OS/2 into the diskette drive.
- 3** Open the OS/2 full screen or OS/2 window.
- 4** Go to the `A:` prompt; then type `INSTALL` and press **Enter**.
- 5** Follow the instructions on the screen.
- 6** After the installation is complete, remove the diskette, shut down OS/2, and restart the system.

You have completed the installation of the display driver for OS/2.

Installing Software for DOS



This section describes the installation procedures for DOS Version 7.0 and its device drivers for your ThinkPad.

Important

Before reinstalling the operating system and device drivers, you need to create all installation diskettes using the Diskette Factory program (diskette backup program) that is preinstalled on your computer.

The software shown in the following figure is already installed at the time of purchase. When reinstalling DOS Version 7.0, install this software for your computer to work as it did:

Page numbers:

- 1 Page 157.
- 2 Page 158.
- 3 Page 161.
- 4 Page 162.

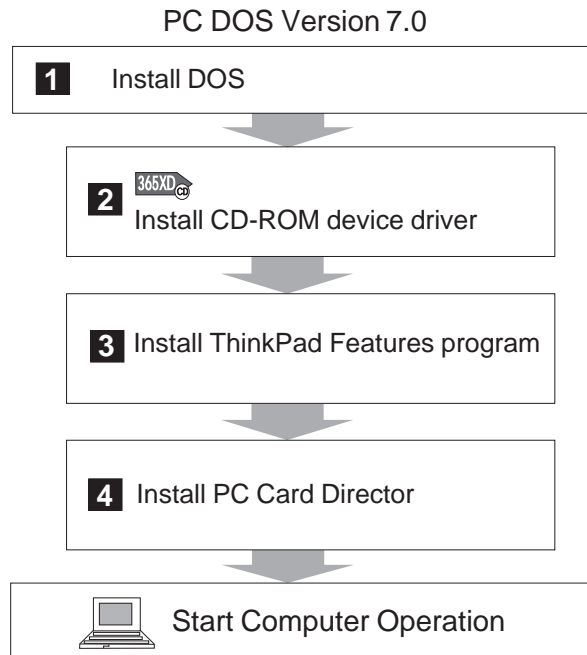

Installing IBM PC DOS Version 7.0

Follow the instructions in the operating-system documentation. If you also are installing Microsoft Windows 3.11, go to “Installing Windows 3.11” on page 165. Otherwise, if you want to continue to install all device drivers, continue with either of the following:

 “Installing the ThinkPad Features Program for DOS” on page 161.

 “Installing the CD-ROM Device Driver for DOS (for the 365XD Only)” on page 158.

Installing the CD-ROM Device Driver for DOS

Installing the CD-ROM Device Driver for DOS (for the 365XD Only)

Note:
When installing an operating system, you need to install the CD-ROM device driver.

Note:
The default subdirectory is C:\CDROM\.

 To install the CD-ROM device driver:

- 1** Start DOS.
- 2** Insert the CD-ROM Diskette into the diskette drive.
- 3** Type `A:UINSTALL` and press **Enter**.
- 4** Select **Install IBM ThinkPad CD-ROM Driver for DOS/Windows** at the Installation Options screen; then follow the instructions on the screen.
- 5** After the installation is complete, remove any diskette from the diskette drive and restart the computer.

You have completed the installation of the CD-ROM device driver. If you want to continue to install all device drivers, continue with "Installing the ThinkPad Features Program for DOS" on page 161.

Installing the CD-ROM Device Driver for DOS

Software Parameters in the CONFIG.SYS and AUTOEXEC.EXE

When the CD-ROM device driver is installed in your computer, the installation program (UINSTALL.EXE) automatically modifies the CONFIG.SYS file and AUTOEXEC.BAT file. The following are the parameters for the CD-ROM device driver:

CD-ROM device driver parameters for the CONFIG.SYS

```
DEVICE=[drive:][path]IBMTPCD.SYS /R [/C] [/S]
```

This is the CD-ROM device driver (IBMTPCD.SYS). Make sure this line is inserted after the EMM386 statement.

- /R** Enables the resident type device driver. Even when the CD-ROM drive is not installed at power-on, the device driver can be loaded in the memory.
- [/C]** Sets the cache size in the XMS memory. When this parameter is set, the cache size in the XMS memory is 512 sectors. When it is not set, the default is 0.
- [/S]** Sets the power-saving mode to OFF. When using DOS with another operating system (for example, when using it with OS/2 in dual boot), set the power-saving mode to OFF using this parameter.

Installing the CD-ROM Device Driver for DOS

CD-ROM device driver parameters for the AUTOEXEC.BAT

– [drive:][path]MSCDEX.EXE /D:TPCD 1
[/M:n][/E][/V][/L:x]

The Microsoft CD-ROM Extensions (MSCDEX.EXE) program is an executable program for MS-DOS Version 7.0 that works in conjunction with the device driver (IBMTPCD.SYS) to allow your computer to access the CD-ROM drive, where the options can be:

- /D** Specifies the name of the CD-ROM drive, TPCD001.
- [/M:n]** Specifies the number of sector buffers to temporarily store the most recent disc data.
- [/E]** Specifies that the computer will use expanded memory, if available.
- [/V]** Displays on the LCD a summary of RAM allocation and expanded memory usage at power-on.
- [/L:drive letter]**
Specifies the drive letter for the CD-ROM drive. Be sure not to assign a drive letter already used by another drive; otherwise, the computer cannot access the CD-ROM drive.

– SMARTDRV cache for photo CDs

If you are using DOS SMARTDRV caches and planning to use a photo CD or multisession discs, you have to add the /U parameter to the SMARTDRV line in the AUTOEXEC.BAT file. This is because photo CDs or multisession discs are not compatible with the SMARTDRV caches.

– To be able to play CD-I movies in Windows 3.11, do not cache the CD-ROM drive by the SMARTDRV Version 5.0 or 5.1, which is supplied with PC DOS Version 7.0.

Installing the ThinkPad Features Program for DOS

Installing the ThinkPad Features Program for DOS

Note:
When installing an operating system, you need to install the ThinkPad Features program.

To install the ThinkPad Features program:

- 1** Start DOS.
- 2** Insert the Utility Diskette 1 into the diskette drive.
- 3** Type `A:UINSTALL` at the DOS prompt and press **Enter**.

The following screen appears:

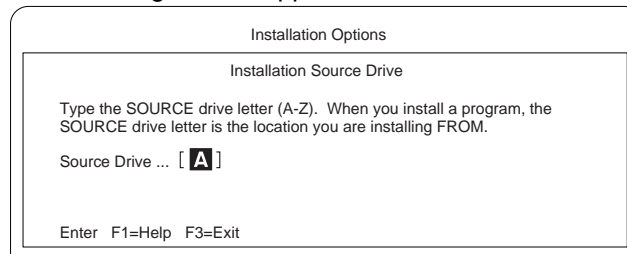

- 4** Press **Enter**.
- 5** Select **Install DOS ThinkPad Features** at the Installation Options screen; then follow the instructions on the screen.

You have completed the installation of the ThinkPad Features program.

If you want to continue to install all device drivers, continue with the PC Card Director.

Installing the PC Card Director for DOS

Installing the PC Card Director for DOS

Note:
Do not install the Phoenix** PCMCIA support in IBM PC DOS 7.0.

PC Card Director:



Page 50.

Note:
The PC Card client device driver is not part of the preinstalled software. Refer to the manual that came with the PC Card to install the device driver.

When installing DOS, you need to install the following software to use the PC Cards:

PC Card device drivers:

- Card Services device driver
- Socket Services device driver
- Resource Map Utility device driver
- PC Card Power Management device driver
- PC Card Director utility

PC Card client device drivers (only when PC Card Director does not support the PC Card)

To install the PC Card Director:

- 1** Start DOS.
- 2** Insert the PCMCIA Installation Diskette for DOS/Windows into the diskette drive.
- 3** Type **A:** at the DOS command prompt and press **Enter** to go to the A: prompt.
- 4** Type `PCMINSTD`; then press **Enter**.
- 5** Follow the instructions on the screen.
Default choices are already highlighted at the Selector screens.
- 6** After the installation is complete, remove any diskette from the diskette drive and restart the computer.

You have completed the installation of the PC Card Director for DOS.

Note:
Whenever you update the CONFIG.SYS file, see page 243.

Installing Software for Microsoft Windows 3.11



This section describes the installation procedures for Microsoft Windows 3.11 and its device drivers for your ThinkPad.

Important

Before reinstalling the operating system and device drivers, you need to create all installation diskettes using the Diskette Factory program (diskette backup program) that is preinstalled on your computer.

The software shown in the following figure is already installed at the time of purchase. When reinstalling Windows 3.11, install this software for your computer to work as it did:

Microsoft Windows Version 3.11

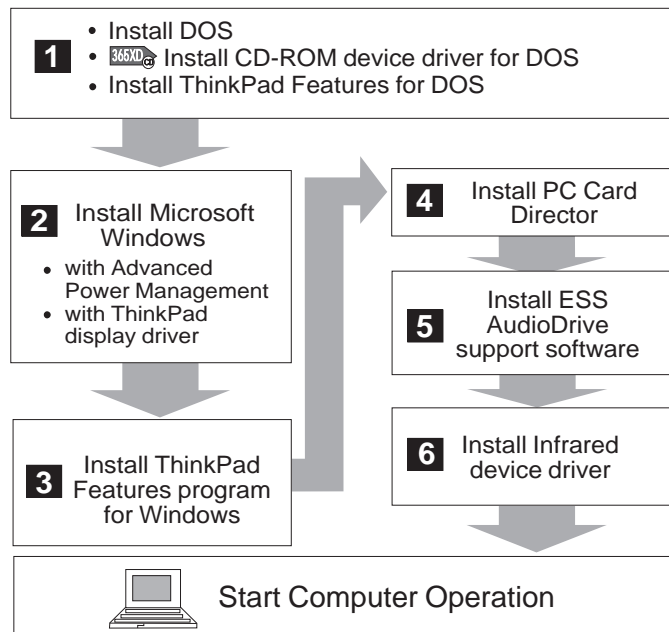

Page numbers:

- 1 Pages 157, 158, and 161.
- 2 Pages 165 and 173.
- 3 Page 169.
- 4 Page 170.
- 5 Page 171.
- 6 Page 172.

Installing Windows 3.11 Software

Important

If you will be installing Windows 3.11, you ***must*** first do the following for Windows 3.11 to operate correctly:

When the Windows Setup program asks you to select either **Express Setup** or **Custom Setup**, select **C** for Custom Setup.

Install the ThinkPad display driver instead of the default device drivers that came with Windows.

Installing Windows 3.11

Windows 3.11 operates in a DOS environment. Install the following before installing Windows:

DOS Version 7.0 (see your DOS manuals)



CD-ROM Device Driver for DOS (see page 158)

ThinkPad Features program for DOS (see page 161)

Important

Before you install Windows 3.11, you **must** do the following for Windows to operate correctly:

When the Windows Setup program asks you to select either **Express Setup** or **Custom Setup**, select **C** for Custom Setup.

Install the ThinkPad display driver instead of the default device drivers that came with Windows.

Do the following to install Windows 3.11 with Advanced Power Management (APM) and the ThinkPad display driver:

- 1** Turn on the computer.
- 2** Install Windows 3.11 *with* the APM option:

Important

When the Windows Setup program asks you to select **Express Setup** or **Custom Setup**, type **C** for **Custom Setup**.

- a)** Start the installation as specified in the Windows manual.

Installing Windows 3.11

Note:

If you have installed OS/2, the path to install Windows may have changed to:

C:\OS2\MDOS\WINOS2
(C is the drive on which you installed OS/2). If so, change the path to:

C:\WINDOWS

- b) When the Windows Setup program asks you to select **Express Setup** or **Custom Setup**, type **C** for **Custom Setup**.
- c) Continue installing Windows 3.11 until the following screen appears:

```
Windows Setup
=====
```

```
Setup has determined that your system includes the following hardware
and software components. If your computer or network appears on the
Hardware Compatibility List with an asterisk, press F1 for Help.
```

```
Computer:      MS-DOS System
Display:       VGA
Mouse:         Microsoft, or IBM PS/2
```

- d) Using the Up Arrow (↑), highlight **MS-DOS System** and press **Enter**.
- e) Select **MS-DOS System with APM** from the list and press **Enter**.
Verify that **Computer** has changed to **MS-DOS System with APM**. If the item has not changed, return to step 2d.

Note:

After installing Windows, you should check the creation date of the following drivers in the DOS subdirectory and the Windows subdirectory:

EMM386.EXE (loaded by CONFIG.SYS)
 HIMEM.SYS (loaded by CONFIG.SYS)
 SMARTDRV.EXE (loaded by AUTOEXEC.BAT)



MSCDEX.EXE (loaded by AUTOEXEC.BAT)

Then use whichever program is newest (either the one for DOS or the one for Windows) when selecting each driver.

You can easily access the newer one by changing the subdirectory name in the CONFIG.SYS or AUTOEXEC.BAT as follows:

```
C:\DOS\SMARTDRV.EXE
↓
C:\WINDOWS\SMARTDRV.EXE
```

Note:

You can change the display resolution by using the ThinkPad Features program after completing the installation of the ThinkPad Features program for Windows.

3 When you have completed the installation of Windows, edit the AUTOEXEC.BAT file so that the computer will use the correct mouse driver.

When Windows 3.11 is installed, the computer is automatically configured to use the MOUSE.COM driver provided by Windows 3.11. However, for correct operation, your computer must use the MOUSE.COM driver that came with DOS.

- a) At the DOS command prompt (usually C:\>), type
`E \AUTOEXEC.BAT` and press **Enter**.
- b) Find the line: `C:\WINDOWS\MOUSE.COM /Y`
- c) Change it to: `C:\DOS\MOUSE.COM /Y`
- d) Find the line that includes `SHARE.EXE` and delete that line.
- e) Save the file and restart the computer.

4 Select your display resolution:

- a) Start DOS and go to the WINDOWS subdirectory.
- b) Type `SETUP` to start Windows setup program.
- c) Using the Up Arrow (↑), highlight **Display** and press **Enter**.
- d) Select **Other (Requires disk...)** from the list.
- e) Insert the Video Features Diskette for Windows 3.1 into the diskette drive; then type `A:` and press **Enter**.
- f) Select your desired resolution from the menu and press **Enter**.

Verify that **Display** has changed to your desired resolution (an example is shown in the following screen). If the item has not changed, return to step 4c.

Installing Windows 3.11

```
Windows Setup
=====
```

```
Setup has determined that your system includes the following hardware
and software components. If your computer or network appears on the
Hardware Compatibility List with an asterisk, press F1 for Help.
```

```
Computer:      MS-DOS System with APM
Display:       Cyber932  8  x6  256 small font
Mouse:         Microsoft or IBM PS/2
```

g) Press **Enter** to continue the installation.

h) After the installation is complete, remove any diskette from the diskette drive and restart the computer.

When you start Windows from the DOS prompt, do not close the LCD while the program is loading; if you do, the computer will stop running.

If you want to continue to install all device drivers, continue with "Installing the ThinkPad Features Program for Windows 3.11" on page 169.

Installing the ThinkPad Features Program for Windows 3.11

Installing the ThinkPad Features Program for Windows 3.11

Note:
When installing an operating system, you need to install the ThinkPad Features program.

If you are going to use Windows, install the ThinkPad Features program for DOS first (see page 161); then do the following to install the ThinkPad Features program for Windows 3.11:

- 1 Turn on the computer and start Windows.
- 2 Select **File** from the Program Manager window; then select **Run...** from the pull-down menu.

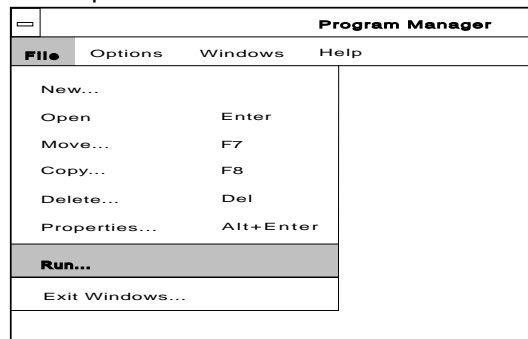

- 3 Insert the Utility Diskette 1 into the diskette drive.
- 4 Type `A:\INSTALLW` and press **Enter**.
- 5 Follow the instructions on the screen.
Default choices are already highlighted at the Installation Options screen.

You have completed the installation of the ThinkPad Features program.

If you want to continue to install all device drivers, continue with "Installing the PC Card Director for Windows 3.11" on page 170.

Installing the PC Card Director for Windows 3.11

Installing the PC Card Director for Windows 3.11

Note:

The PC Card Director for Windows 3.11 must be installed with Windows 3.11 or a later version with enhanced mode. Otherwise, it cannot be installed.

To use PC Card Director:



Page 50.

When installing an operating system, you need to install the PC Card Director. You must install the following device drivers and software associated with PCMCIA before you can use the PC Cards:

- Card Services device driver
- Socket Services device driver
- Resource Map Utility device driver
- PC Card Power Management device driver
- PC Card Director Utility
- PC Card client device drivers (only when PC Card Director does not support the PC Card)

To install the PC Card Director:

- 1** Turn on the computer and start Windows.
- 2** Select **File** from the Program Manager window; then select **Run...** from the pull-down menu.
- 3** Insert the PCMCIA Installation Diskette for DOS/Windows into the diskette drive.
- 4** Type `A:PCMINSTW` and press **Enter**.
- 5** Follow the instructions on the screen to complete the installation.
Default choices are already highlighted at the choice screens.
- 6** After the installation is complete, remove any diskette from the diskette drive and restart the computer.

You have completed the installation of the PCMCIA device driver for Windows 3.11.

If you want to continue to install all device drivers, continue with "Installing the AudioDrive Support Software for Windows 3.11" on page 171.

Installing the AudioDrive Support Software for Windows 3.11

Installing the AudioDrive Support Software for Windows 3.11

- 1** Turn on the computer and start Windows.
- 2** Select **File...** from the Program Manager window; then select **Run...** from the pull-down menu.

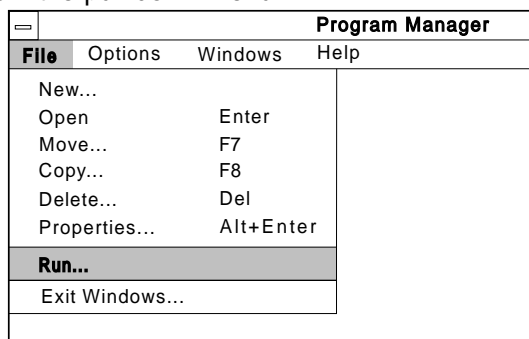

- 3** Insert the AudioDrive Features Diskette for Windows into the diskette drive of your computer.
- 4** Type **A:\SETUP**; then press **Enter**.
- 5** Follow the instructions on the screen to complete the installation.

If you want to continue to install all device drivers, continue with "Installing the Infrared Device Driver for Windows 3.11" on page 172.

Installing the Infrared Device Driver for Windows 3.11

Installing the Infrared Device Driver for Windows 3.11

Note:

When installing an operating system, you need to install the Infrared device driver.

- 1 Turn on the computer; then go to the DOS command prompt.
- 2 Insert the Infrared Features Diskette into the diskette drive.
- 3 Type `A:UINSTALL` and press **Enter**.

The following screen appears:

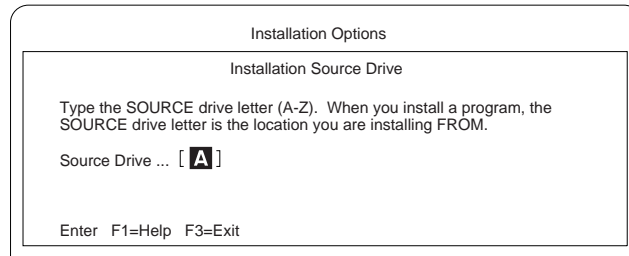

- 4 Press **Enter**; then follow the instructions on the screen.

Select **Install Windows ThinkPad InfraRed Driver** when you are asked.

You have completed the installation of the Infrared device driver for Windows 3.11.

For the standard video model, you have completed all the device drivers for Windows 3.11.

If you want to continue to install all device drivers, continue with "Installing the ThinkPad Display Driver for Windows 3.11" on page 173.

Installing the ThinkPad Display Driver for Windows 3.11

Installing the ThinkPad Display Driver for Windows 3.11

If you did not install the display driver when Windows was installed (by following the procedures on page 165), you must install the ThinkPad display device driver. The display driver enables you to use various screen resolutions and colors for the LCD and external monitor. (See page 45 for possible combinations of resolution and color.)

The display driver also takes advantage of the computer's video capability.

To install the ThinkPad device driver:

- 1** Turn on the computer.
- 2** If Windows is running on your computer, exit Windows and switch to the DOS prompt.
- 3** Go to the Windows subdirectory and type `SETUP`; then press **Enter**.
- 4** Select **Display** from the Windows Setup menu; then select **Other (Requires disk...)**.
- 5** Insert the Video Features Diskette for Windows 3.1 into the diskette drive; then type `A:\` and press **Enter**.
- 6** Select your desired resolution from the menu and press **Enter**. Follow the instructions on the screen.

You have completed the installation of the display driver for Windows 3.11.

Installing Software for Microsoft Windows 95



This section describes the installation procedures for Windows 95 and its device drivers for your ThinkPad.

Important

Before reinstalling the operating system and device drivers, you need to create all installation diskettes using the Diskette Factory program (diskette backup program), which is preinstalled on your computer.

The software shown in the following figure is already installed at the time of purchase. When reinstalling Windows 95, install this software for your computer to work as it did:

Microsoft Windows 95

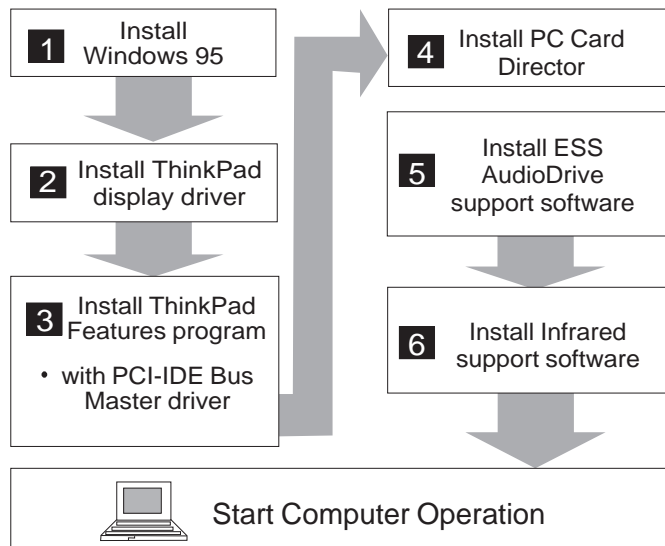

Page numbers:

- 1 Page 175.
- 2 Page 177.
- 3 Pages 178 and 179.
- 4 Page 180.
- 5 Page 184.
- 6 Page 186.

Installing Windows 95

Install Windows 95 as described in its documentation.

While Installing Windows 95

During the installation of Windows 95, make sure of the following:

On the Setup Options screen of the Windows 95 Setup Wizard, select **Custom**; then click on the **Next>** button.

On the Analyzing Your Computer screen of the Windows 95 Setup Wizard:

1. Select **No, I want to modify the hardware list**; then click on the **Next>** button.
2. Select and highlight **Display** in the “Hardware types” list box.
3. Remove the check mark () from “S3 801/805/928/864/964 Display Adapter” and “S3 Display Adapter” in the Manufacturer and model list box.
4. Click on the **Next>** button.

Follow the instructions on the screen to complete the installation for Windows 95.

For more details, refer to the Windows 95 documentation.

Encounter a problem??

If you did not follow the instructions in the previous **While Installing...** box, your computer screen might black out during the Windows 95 installation. If this is the case, do the following to recover from the problem:

1. When your computer blacks out, wait until the hard disk activity stops; then restart the computer.
2. Start the Windows 95 setup from the beginning.
3. On the Safe Recovery screen of the Windows 95 Setup Wizard, select **Use Safe Recovery (recommended)**; then click on the **Next>** button.
4. On the Setup Options screen of the Windows 95 Setup Wizard, select **Custom**; then click on the **Next>** button.
5. On the Analyzing Your Computer screen of the Windows 95 Setup Wizard, select **Yes, redetect now**; then click on the **Next>** button.
6. Follow the instructions to complete the installation of Windows 95.

You may encounter `Unknown Hardware Found` messages when you install Windows 95. In these cases, select **Do not install a driver (Windows will not prompt you again)**.

Installing the ThinkPad Display Driver for Windows 95

To install the ThinkPad display driver for Windows 95, do the following:

- 1** Make sure that Windows 95 has been installed in your computer.
- 2** Start Windows 95.
- 3** Open **My Computer**.
- 4** Open **Control Panel** and open **Display**; then click on the **Settings** tab.
- 5** Click on the **Change Display Type...** button.
- 6** Make sure that **Trident** SuperVGA** is set to “Adapter Type” (as a default value); then click on **Change...**
- 7** Insert the ThinkPad Video Feature Diskette for Windows 95 into the diskette drive.
- 8** Click on **Have disk...** and click on **OK**.
- 9** Make sure that **IBM ThinkPad (Cyber9320)** is selected. Then click on **OK**.
- 10** Click on **Close**.
- 11** Select your screen parameters from the Color palette, Desktop area, and Font size; then click on **OK**.
- 12** Click on **Close**; then click on **Close** again.
- 13** Follow the instructions on the screen.
Windows 95 prompts you to restart the computer to make the display driver change effective.

Note:

If you do not know what to choose, try the following: **256 Colors** for the Color palette, **800 x 600 pixels** for the Desktop area, and **Small Fonts** for the Font size.

You have completed the installation of the ThinkPad display driver.

Installing the ThinkPad Features Program for Windows 95

The ThinkPad Features program *for Windows* works on Windows 95.

If you installed Windows 95 on a computer in which DOS/Windows and its ThinkPad Features program were already installed, the ThinkPad Features program is migrated into the "Start Menu" of Windows 95 automatically.

To start the ThinkPad Features program:

- 1** Click on **Start**.
- 2** Select **Programs**; then select **ThinkPad**.
- 3** Select **ThinkPad Features**.

If you installed Windows 95 on a blank hard disk or if you have not installed the ThinkPad Features program:

Install the ThinkPad Features program using the Utility Diskette supplied with the computer:

- 1** Insert the ThinkPad Utility Diskette 1 into the diskette drive.
- 2** Click on **Start**.
- 3** Click on **Run....**
- 4** Type `a:INSTALLW`; then click on **OK**.
- 5** Follow the instructions on the screen.

You have completed the installation of the ThinkPad Features program.

If you want to continue to install all the device drivers, go to "Installing the PCI-IDE Bus Master Driver for Windows 95" on page 179.

Installing the PCI-IDE Bus Master Driver for Windows 95

Note:

When installing an operating system, you need to install the PCI-IDE Bus Master driver to improve the performance of the hard disk drive in the computer.

To install the PCI-IDE Bus Master driver:

- 1** Start Windows 95
- 2** Select **My Computer**, **Control Panel**, and then **System**.
- 3** Click on the **Device Manager** tab.
- 4** Click on the + mark for hard disk controllers.
- 5** Click on **Standard IDE/ESDI Hard Disk Controller**, and click on the **Remove** button.
Press **OK** when prompted to remove this controller.
- 6** Select **Yes** when prompted to restart Windows 95.
Windows 95 restarts.
- 7** At the New Hardware Found screen, select **Driver from disk provided by hardware manufacturer**.
- 8** Insert Utility Diskette 2 into the diskette drive.
- 9** Click on **OK**.
- 10** Select **Yes** when prompted to restart Windows 95.

You have completed the installation of the PCI-IDE Bus Master driver for Windows 95.

If you want to continue to install all device drivers, continue with "Installing the PC Card Director for Windows 95" on page 180.

Installing the PC Card Director for Windows 95

Installing the PC Card Director for Windows 95

Note:

The ThinkPad computer has three different sets of PCMCIA Feature software: one for DOS/Windows, one for OS/2 Warp, and one for Windows 95.

To use the PCMCIA features in the Windows 95 environment, you need to do the following. Each step will be explained in detail following this summarized procedure.

1. If you have already installed the PC Card Director for DOS and Windows, disable it (enable the Windows 95 Integrated PCMCIA support software).
2. Install the Socket Services device driver.
3. Install the PC Card Director for Windows 95.

Disabling the PC Card Director for DOS and Windows

If the PC Card Director for DOS and Windows has been already installed on your computer, you must remove the PC Card Director for DOS and Windows before installing the PCMCIA support software for Windows 95. This is because the Windows 95 installation program does not automatically remove the PC Card Director for DOS and Windows.

To remove the PC Card Director for DOS and Windows, do the following (this procedure also enables the Windows 95 Integrated PCMCIA support software):

- 1 Start Windows 95.
- 2 Select **My Computer**, **Control Panel**, and **PC Card**.
- 3 Select **No** for the question "Are you using a PC card to install Windows?" and click on **Next**.
- 4 Select **No** for the question "Do you want to review your system files and select real-mode PC card drivers so Windows can disable them?"
- 5 Click on **Finish** to complete the Windows 95 PCMCIA support setup.
- 6 Restart your computer.

You have removed the PC Card Director for DOS and Windows. To install the ThinkPad PC Card Director for Windows 95, continue to the following section.

Installing the PC Card Director for Windows 95

Installing the Socket Services Device Driver: Prepare your Windows 95 product diskettes or CD-ROM, if you do not already have the Windows 95 integrated PCMCIA support software installed on your computer.

To install the ThinkPad Socket Services device driver for Windows 95:

- 1** Start Windows 95.
- 2** Select **My Computer**, **Control Panel**, and **System**.
- 3** Click on the **Device Manager** tab.
- 4** Click on the + mark for **PCMCIA socket**.
- 5** Double-click on **PCIC or compatible PCMCIA controller**.
- 6** Click on the **Driver** tab to see the **Driver files:** list.
- 7** Click on the **Change Driver...** button.
- 8** Click on the **Have Disk...** button.
- 9** Insert the PCMCIA Installation Diskette for OS/2, Windows 95 into the diskette drive.

Installing the PC Card Director for Windows 95

- 10** Click on the **OK** button; then you will see the “PCIC or compatible PCMCIA controller on IBM system” item in the “Models:” list.
- 11** Click on the **OK** button.
IBMCSS01.VXD and IBMPCDIF.VXD will be listed in the “Driver files:” list.
- 12** Click on the **OK** button.
Windows 95 now starts copying files. The “Insert Disk” panel asks for one of the Windows 95 installation diskettes or the CD-ROM.
- 13** Change the source for “Copying files from:” to A:\ when Windows 95 tries to copy IBMCSS01.VXD or IBMPCDIF.VXD.
- 14** Insert the diskette labeled PCMCIA Installation Diskette for OS/2, Windows 95 into the diskette drive.
- 15** Click on **OK**.
IBMCSS01.VXD and IBMPCDIF.VXD are copied from the diskette.
- 16** Click on the **OK** button at the “Insert Disk” panel.
- 17** Click on the **Skip File** button at the “Copying Files...” panel when Windows 95 tries to copy the following files:
 - CARDDR.VEXE
 - CSMAPPER.SYS
 - FLS1MTD.VXD
 - FLS2MTD.VXD
 - PCCARD.VXD
 - SRAMMTD.VXD
- 18** Restart the computer.

Note:
These files were copied when you installed the Windows 95 integrated PCMCIA support software.

You have completed the installation of the ThinkPad Socket Services device driver. Continue with “Installing the PC Card Director for Windows 95” on page 183.

Installing the PC Card Director for Windows 95

Installing the PC Card Director for Windows 95: To install the PC Card Director for Windows 95, do the following:

- 1** Start Windows 95.
- 2** Open **My Computer**.
- 3** Open **Control Panel**.
- 4** Open **Add/Remove Programs**.
- 5** Click on the **Install...** button.
- 6** Insert the PCMCIA Installation Diskette for OS/2, Windows 95 into the diskette drive.
- 7** Click on the **Next>** button.
- 8** Click on the **Finish** button when you see the "A:\INSTALLP.EXE" on the screen.
- 9** Click on the **Continue** button when the opening panel of the installation program appears on the screen.
- 10** Follow the instructions on the screen.
- 11** Remove the diskette from the diskette drive.

You have completed the installation of the PC Card Director for Windows 95.

If you want to continue to install all the device drivers, go to "Installing the AudioDrive Support Software for Windows 95" on page 184.

Installing the AudioDrive Support Software for Windows 95

When installing Windows 95, the software might detect the AudioDrive chip installed in your computer, and automatically install the required software in your hard disk drive.

However, the version of the AudioDrive support software supplied with Windows 95 might be a version earlier than the one needed for your computer.

You should reinstall the AudioDrive support software as follows:

- 1** Turn on the computer and start Windows 95.
- 2** Open **My Computer**.
- 3** Open **Control Panel** and open **System** to open the System Properties window.
- 4** Click on the **Device Manager** tab; then double-click on **Sound, video, and game controllers** from the list.
- 5** Double-click on **ESS AudioDrive**.
- 6** Click on the **Driver** tab.
- 7** Click on the **Change Driver** button.
- 8** Click on the **Have Disk...** button.
- 9** Insert the Audio Features Diskette for Windows 95 into the diskette drive, and click on **OK**.
- 10** Click on **OK** until you see the following error message:



Installing the AudioDrive Support Software for Windows 95

- 11** Make sure the Audio Features Diskette for Windows is inserted in the diskette drive; then click on **OK**.
- 12** Type `A:\` at the Copy Files From window; then click on **OK**.
The installation begins.
- 13** After the installation is complete, click on the **Close** button.

You have completed the installation of the AudioDrive Support Software for Windows 95.

If you want to continue to install all the device drivers, go to “Installing the Infrared Device Driver for Windows 95” on page 186.

Installing the Infrared Device Driver for Windows 95

To install the Infrared device driver for Windows 95, do the following:

- 1** Start Windows 95; then go to the MS-DOS command prompt.
- 2** Insert the Infrared Features Diskette into the diskette drive.
- 3** Type `A:UINSTALL` and press **Enter**.
- 4** At the "Installation Options" screen, press **Enter** to accept the default source drive.
- 5** Follow the instructions on the screen.
- 6** Select **Install Windows ThinkPad Infrared Driver** when you are asked.

Make sure you specify the directory where you have installed Windows 95 when asked.

You have completed the installation of the Infrared device driver. Continue with "Points to Consider When Using Windows 95" on page 187.

Points to Consider When Using Windows 95

Consider the following when you use Windows 95 with your computer:

Disabling the Docking Control Utility:

All the docking functions, once provided by the ThinkPad Docking Control Utility program for Windows, are now supported by the ThinkPad Plug-and-Play BIOS and Windows 95.

If you have installed Windows 95 on a computer in which the Docking Control Utility for Windows had already been installed, stop this utility program from working as follows:

Note:

For example, type `EDIT NODRIVER.INF` and press **Enter** to open the file.

1 Open the WIN.INI file using your editor.

2 Remove the following statement:

```
[windows]
:
load=C:\THINKPAD\DOCKWIN.EXE ← Remove this statement
:
```

3 Save and close the file.

4 Open the SYSTEM.INI file using your editor.

5 Remove this statement:

```
[386Enh]
:
device=IBMPNP.386 ← Remove this statement
```

6 Save and close the file.

7 Restart Windows to make the changes effective.

When Using Windows 95

Chapter 8. Solving Computer Problems

Computer problems can be caused by software, hardware, or both. You can diagnose and solve many problems with the assistance of the self-tests and system programs contained in Easy-Setup. If a hardware problem is detected by the self-tests, an error message is displayed.

The system programs can identify a problem or provide information for the service representative. Make a note of all error codes, and give them to the service representative when you call for service. If the system programs cannot be loaded, the troubleshooting charts and other information will help you determine what corrective action to take.

Important

Use this chapter to test only *IBM* products. Non-*IBM* products can cause misleading error information or incorrect computer responses. When testing non-*IBM* products, refer to the instructions supplied with those products.

Common Problems and Frequently Asked Questions	190
Common Problems and Actions	190
Frequently Asked Questions and Answers	192
Testing the Computer	193
Troubleshooting Charts	195
Error Codes	195
LCD Blank or Power-On Problems	198
Screen Messages	200
Other General Problems	201
What If Testing Cannot Find the Problem?	203
Battery Power Problems	203
CD-ROM Drive Problems	204
Diskette Drive Problems	205
Port Replicator Problems	205
External Monitor Problems	206
Hibernation Problems	207
Infrared Communication Problems	207
Keyboard, External Numeric Keypad, and Pointing Device Problems	208
Option Problems	209
PC Card Problems	210
Printer Problems	211
Software Problems	212
Getting Service	213
Listing Installed Options	213

Troubleshooting

Recording Identification Numbers	214
Getting Help, Service, and Information	215
Solving Problems	215
Using the HelpWare Support Family	216
Purchasing Additional HelpWare Services	220
Custom Services	222
Obtaining IBM Operating System Updates	223
About Your Warranty	223
Service outside North America	224

Common Problems and Frequently Asked Questions



This section provides:

Common problems and their corresponding actions.
Frequently asked questions and their answers.

Common Problems and Actions

Problems	Actions
My modem application does not work with the PC Card modem.	<p>If the PC Card Director shows the PC Card modem status "Ready," add the following option switch in the CONFIG.SYS file:</p> <p><i>For DOS:</i></p> <pre>DEVICE=C:\THINKPAD\IBMDSS 1.SYS /IO =x (or /IO1=x)</pre> <p><i>For OS/2:</i></p> <pre>DEVICE=C:\THINKPAD\IBM2SS 1.SYS /IO =x (or /IO1=x)</pre> <p>Note: x shows the PC Card slot number (1 for the upper slot, 2 for the lower slot, or 12 for both slots) on the computer and /IO1= shows the slot number for an expansion unit or port replicator that is attached to the computer.</p>
I cannot use PC Cards other than IBM ones in the OS/2 Warp environment.	<p>If you do not have the PC Card device driver for OS/2 but you have one for DOS, your PC Card may run in the VDM (virtual DOS machine) environment. Refer to "Virtual Card Services for OS/2" on page 256 for setting the VDM and the sample configuration files on the PCMCIA Installation Diskette for OS/2, Windows 95. (If the PCMCIA Installation Diskette for OS/2, Windows 95 did not come with the computer, create it using the Diskette Factory program.)</p>
My computer does not show as good performance as I expected.	<p>Performance varies depending on your hardware and software configurations such as memory size, swapper file size, or smart drive settings.</p>
Error 2XX appears (memory error).	<p>Make sure your memory card is correctly installed. (See page 119.)</p>

Troubleshooting

Problems	Actions
A memory shortage or memory error occurs.	<p><i>When you are using DOS, you should use the DOS command <code>MEM /C</code> to review your DOS memory usage occasionally. And then:</i></p> <ul style="list-style-type: none">– Unload any unnecessary drivers from the <code>CONFIG.SYS</code> file. (For example, unload printer drivers if you do not use a printer.)– Reconfigure the UMB (upper memory block) using the <code>DEVICEHIGH</code> statement.– Use the multiple configuration setup for DOS (refer to the documents supplied with DOS). <p><i>When you are using Windows:</i></p> <ul style="list-style-type: none">– Try the same actions as described for DOS.– Unload any unnecessary programs from the <code>WIN.INI</code> file (for example, <code>FUELWIN</code> for AC operations, <code>LRGPTR</code> for large pointer, and so on).
The external monitor screen is blank.	<p>Do the following:</p> <p>Make sure the display output type parameter of the ThinkPad Features program is set to CRT () or Both (.</p> <p>In the ThinkPad Features program, set the computer not to enter suspend mode when the LCD is closed.</p>
The computer does not resume from suspend mode , or the suspend indicator stays on and the computer does not work.	<p>The computer automatically enters suspend or hibernation mode when the battery pack is empty. Do one of the following:</p> <p>Replace the battery pack with a fully charged one and then press Fn. Connect the AC Adapter to the computer.</p>
The computer does not enter suspend or hibernation mode .	<p>Verify that:</p> <p>If the computer is attached to a Port Replicator, suspend mode is disabled.</p> <p>If you are using the AC Adapter and the computer is communicating, suspend and hibernation modes are disabled. (See page 77.)</p>
When using Windows, the pointer does not move after normal operation is resumed from one of the power-saving modes.	<p>Make sure you have installed Windows with the APM option by following the procedures on page 165.</p>

Frequently Asked Questions and Answers

Questions	Answers
How can I expand my hard disk space?	Most of the preloaded applications provide a way to be uninstalled and free hard disk space. Check whether or not the application you want to delete has its own delete icon.
How can I expand my memory?	See answers to memory questions on page 191.
How can I get diskettes for operating systems or device drivers?	You can create the operating systems diskettes or device driver diskettes by using the Diskette Factory program or any other backup programs. If you cannot use the Diskette Factory program, do the following: In the U.S., access the IBM PC Company BBS to get the latest versions of device driver diskettes. Purchase the operating system diskettes or device driver diskettes. Contact your IBM dealer or IBM marketing representative. (See page 216 for IBM HelpWare information.)
How can I resolve any resource conflicts (for IRQ, COM port, and other settings) that have occurred after installing a new option or a new application?	See Appendix A, Avoiding Hardware Conflicts to get information about any hardware resources already used by devices in the computer.

Testing the Computer

The following shows a basic way to test the computer:

1 Turn on the computer.

The power-on self-test (POST) runs automatically. If the test ends without detecting an error, one of the following occurs:

The operating system or application screen appears.

A password prompt appears on the screen, if a password has been set. Type the correct password and press **Enter**.

The **Diskette** and **F1** prompts (shown below) appear.

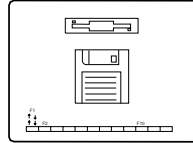

This means no operating system is installed in your computer. Install it now.

Did one of these screens appear?

Yes Turn off the computer and continue with step 2.

No Go to page 195.

2 Make sure the speaker volume control is in the middle position.

3 Press and hold **F1**; then turn on the computer to start Easy-Setup. Hold **F1** until the following Easy-Setup menu appears.

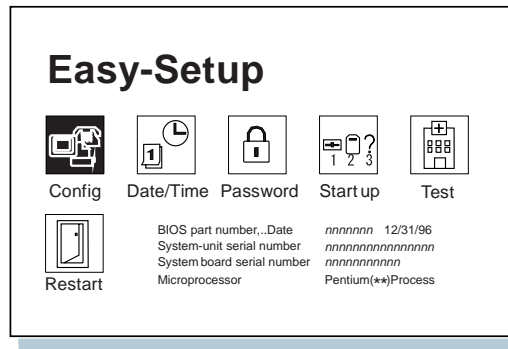

4 Did the Easy-Setup menu appear on the screen?

Yes The computer has successfully completed the POST (internal tests), and the system programs have been loaded. To start the test programs, select the **Test** icon; then select the **Start** icon or press **Enter**.

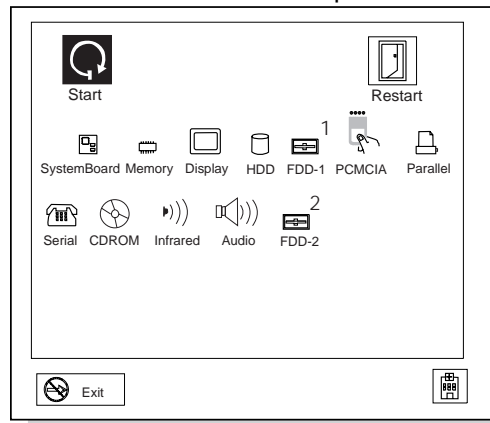

If the computer did not beep, the speaker is not working correctly. Check that the speaker volume control (see page 15 for the location) is in its middle position. If you are not sure about the beep, turn off the computer; then turn it on again and repeat step 3 on page 193. If a problem still exists, have the computer serviced.

If you cannot go beyond the first screen, have the computer serviced.

If an error is detected, the character X appears at the left of the affected device, and an error code appears below it. Record the error code and have the computer serviced.

If the test does not find a problem but one still exists, find the problem in “Troubleshooting Charts.”

No Return to step 3 on page 193 and start Easy-Setup again. If you still cannot start Easy-Setup, find the problem in “Troubleshooting Charts.”

Troubleshooting

Troubleshooting Charts

In the charts, x can be any character.

Error Codes

Screen Message and Its Meaning	Action
I9990301 I9990302 I9990305 (Incorrect connection of the hard disk drive can cause these error codes to appear.)	The computer cannot find the startup drive. Do the following: <ol style="list-style-type: none"> 1. Turn off the computer. 2. Press and hold F1; then turn on the computer to start Easy-Setup. Hold F1 until the Easy-Setup menu appears. 3. Select the Start up icon. If you are unable to set the startup sequence, have the computer serviced. 4. Check the list of devices on the startup sequence box. Is the default drive listed in the startup sequence box? <ul style="list-style-type: none"> Yes Exit this screen, and turn off the computer. No Select the Reset icon. 5. Is an operating system installed? <ul style="list-style-type: none"> Yes Go to step 7. No Install operating system in your computer. 6. After the operating system is installed, turn off the computer. 7. Turn on the computer. If the same screen message appears, have the computer serviced.
I99xxxxx (Except the preceding I999030x errors)	Have the computer serviced.
111 (Expansion unit error)	If you are using a port replicator or an expansion unit, disconnect it; then reconnect it. If there is still a problem, have the computer serviced.
158 (Supervisor password error)	A hard disk drive without a hard disk password is installed when a supervisor password is set. To solve the problem, do the following: <ol style="list-style-type: none"> 1. Type your supervisor password at the power-on password prompt. If a 00158 error screen appears, press Enter to proceed to the Easy-Setup password screen. 2. Select the Supervisor icon; then press Enter. The same password as the supervisor password is set for the hard disk password on the hard disk drive. 3. Turn off the computer.

Troubleshooting

Screen Message and Its Meaning	Action
159 (Supervisor password error)	The hard disk password differs from the supervisor password. To solve the problem, do the following: <ol style="list-style-type: none"> 1. Turn off the computer; then turn it on again. 2. Change the hard disk password to the supervisor password at the hard disk password prompt.
16x or 17x (Undefined date or configuration error)	Follow the instructions on the screen.
174 (Device configuration error)	There is a device configuration error. Check that the hard disk drive and the other devices are installed firmly in their connectors.
184 (Invalid password error)	The entered password is invalid. Turn off the computer and wait at least 5 seconds; then turn it on again and type the correct password.
190 (Critical low-battery error)	The computer has turned off because of a critical low-battery condition. Connect the AC Adapter to the computer and charge the battery pack, or replace the battery pack with the fully charged one.
195 (Hibernation error)	The system configuration before and after hibernation mode differs, and the computer cannot resume normal operation. <p style="margin-left: 40px;">Change the system configuration to what it was before the computer entered hibernation mode.</p> <p style="margin-left: 40px;">If the memory size is changed, re-create the hibernation file (see page 79).</p>
196 (Hibernation error)	The computer cannot read the hibernation file. Have the computer serviced.
2xx (Memory error)	Verify that the DIMM option is correctly installed.

Troubleshooting

Screen Message and Its Meaning	Action
30x (Keyboard error)	<p>Verify that nothing is pressing on the system keyboard or the external keyboard. Turn off the computer and all attached devices. Turn on the computer first; then turn on the attached devices.</p> <p>If there is still a problem, do the following:</p> <p>If the computer has an external keyboard connected, do the following:</p> <ul style="list-style-type: none">– Turn off the computer and disconnect the external keyboard; then turn on the computer. If no error occurred, your external keyboard might be damaged. Have the external keyboard serviced.– Verify that the external keyboard is connected to the correct side of the external input-device connector (see page 18).– Verify that the external input-device connector is correctly connected to the computer. <p>If the preceding items are correct, disconnect the external input-device connector from the computer and verify that the operation of the system keyboard is correct. If the system keyboard works correctly, have the external input-device connector or the external keyboard serviced.</p> <p>Test the computer by selecting the Start icon in the Test menu of Easy-Setup.</p> <ul style="list-style-type: none">– If the computer stops during testing and does not continue, have the computer serviced.



LCD Blank or Power-On Problems

Problem	Action
<p>The screen is blank and there are no beeps.</p> <p>Note: If you are not sure about the beeps, turn the computer off; then turn it on again, and listen to the beeps.</p>	<p>Verify that:</p> <ul style="list-style-type: none"> The battery pack is correctly installed. The AC Adapter is connected to the computer and the power cord is plugged into a working electrical outlet. The computer power switch is turned on. <p>If the preceding items are correct and the screen remains blank, have the computer serviced.</p>
<p>The screen is blank and there is one beep.</p> <p>Note: If you are using an external monitor, go to "External Monitor Problems" on page 206.</p>	<p>If a power-on password is set, press any key to display a power-on password prompt and then type the correct password and press Enter (see page 85).</p> <p>If a power-on password is not set, verify that the brightness control on the computer is correctly adjusted. If the preceding items are correct and the screen remains blank, have the computer serviced.</p>
<p>The screen is blank and there is a continuous beep, or two or more beeps.</p>	<p>Have the computer serviced.</p>
<p>Only the cursor appears.</p>	<p>Reinstall your operating system and turn on the computer.</p> <p>If there is still a problem, have the computer serviced.</p>
<p>xxxxx KB OK appears and the computer halts.</p>	<p>Have the computer serviced.</p>
<p>The screen is unreadable or distorted.</p>	<p>Verify that:</p> <ul style="list-style-type: none"> The ThinkPad display driver is installed correctly (refer to the Chapter 7 for installation instructions). The refresh rate settings in the ThinkPad Features program's display setup screen (under the Advanced... button) are set to your display resolution and color type.
<p>Incorrect characters appear on the screen.</p>	<p>Verify that operating systems and application programs have been installed and configured correctly.</p> <p>If so, have the computer serviced.</p>
<p>The screen stays on although the power switch is turned off.</p>	<p>Press the Power Shutdown switch on the rear of the computer with the tip of a pen to turn off the computer; then turn the computer on again.</p>
<p>The computer goes into suspend mode immediately after the POST. (The suspend lamp turns on.)</p>	<p>Verify that:</p> <ul style="list-style-type: none"> The battery pack is charged. The keyboard is firmly closed. The environmental temperature is within the acceptable range. Refer to Appendix D, Features and Specifications. <p>If the preceding items are correct, have the computer serviced.</p>

Troubleshooting

Problem	Action
Error 190 appears and the computer immediately turns off.	The battery pack is low in power. Connect the AC Adapter to the computer, or replace the battery pack with a fully charged one.
Missing, discolored, or bright dots appear on the screen at all times (TFT color display model only).	The computer LCD contains more than 1,440,000 thin-film transistors (TFTs). A small number of missing, discolored, or bright dots on the screen is an intrinsic characteristic of TFT LCD technology and is not an LCD defect.

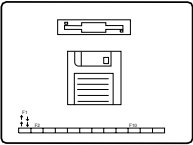
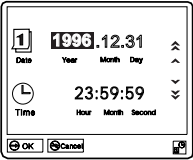
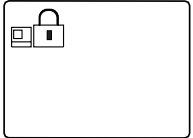
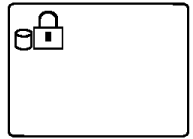
Screen Messages

Message	Action
<p>Diskette and F1 prompts.</p> 	<p>Verify that the hard disk drive is correctly installed. Or, verify that the self-starting diskette is inserted correctly (with the label up and metal-shutter end first) in the diskette drive.</p> <p>If so, press F1. If both prompts remain, have the computer serviced.</p>
<p>Error 163 appears with the date and time screen.</p> 	<p>The date and time screen appears when neither the date nor the time is set in the computer.</p> <p>Set the date and time by typing or clicking on the ▲ or ▼ to set the numbers; then click on the OK button.</p>
<p>Power-on password prompt.</p> 	<p>A power-on or supervisor password was set. To use the computer, type the correct password and press Enter (see page 85).</p> <p>If the power-on password is not accepted, a supervisor password might have been set. Type the supervisor password and press Enter.</p> <p>If there is still a problem, have the computer serviced.</p>
<p>Hard disk password prompt.</p> 	<p>A hard disk password was set. To use the computer, type the correct password and press Enter (see page 85).</p> <p>If there is still a problem, have the computer serviced.</p>
<p>Test menu.</p> 	<p>Select the Start icon and follow the instructions to test your system.</p> <p>If you cannot go beyond the Test screen, have the computer serviced.</p> <p>If the computer stops during testing and does not continue, have the computer serviced.</p> <p>If testing does not find a problem but one still exists, find the problem in “What If Testing Cannot Find the Problem?” on page 203.</p> <p>If the test ends with an error, make a note of the error code and have the computer serviced.</p>

Troubleshooting

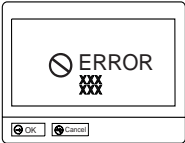
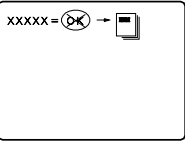
Message	Action
POST error prompt. 	An error was found during the POST. Press Enter ; then select Start from the test menu to run the test. If the test ends with an error, make a note of the error code and have the computer serviced.
Error prompt. 	Turn off the computer and start Easy-Setup; then select Test to test the computer. If the test ends with an error, make a note of the error code and have the computer serviced. You can start the operating system by pressing F1 instead and ignore the error.
A screen or message that is not listed.	Turn off the computer and start Easy-Setup; then select Test to test the computer. If the test ends with an error, make a note of the error code and have the computer serviced. If you cannot start Easy-Setup, have the computer serviced.

Other General Problems

Problem	Cause or Action
The computer locks up or does not accept any input.	 When you turn on the computer with OS/2 Warp installed, make sure no compact disc (CD) is in the CD-ROM drive. Some CDs cause the computer to lock up and accept no input when the computer is turned on with the CD installed. If the computer locks up with the CD installed in the CD-ROM drive, remove the CD, turn off the computer, and turn the computer on again. To turn the computer off, press the Power Shutdown switch on the rear of the computer with the tip of a pen to turn off the computer; then turn the computer on again.
The computer enters suspend mode automatically.	The computer enters suspend mode automatically when the processor temperature is higher than a certain degree. This is not a defect.
The computer performance is getting worse in an environment where the temperature is higher than the product specifications. (See Appendix D, Features and Specifications.)	Processor speed may decrease if the computer is used in a high-temperature environment. This is not a defect.

Troubleshooting

Problem	Cause or Action
The computer has problems such as a broken keylock or a defective indicator lamp.	Have the computer serviced.
The computer does not turn off with the power switch.	If the suspend lamp is turned on, connect the AC Adapter or install a fully charged battery pack in the computer; then resume operation.
The computer does not start from a diskette.	Check that the startup sequence in Easy-Setup is set to start the computer from the diskette drive (see page 41).
The keyboard cannot be opened.	Check that a Kensington lock or compatible lock is not in use. See page 102. Note: Slide the keyboard latches toward the front to open the keyboard.

Troubleshooting

What If Testing Cannot Find the Problem?

If the test programs do not find the problem, use these troubleshooting charts:

Battery Power Problems

Problem	Action
When you are using OS/2 or Windows, the message, "Please discharge battery" appears on the screen.	Discharge the battery pack; then recharge it using the Fuel-Gauge program (see page 68).
The battery status indicator has turned off although a battery pack is installed in the computer.	The over-current protection device inside the battery pack has been activated. Wait for several hours and try to use it again. If there is still a problem, replace the battery pack or have the computer serviced.
The battery pack cannot be fully charged in 3 hours by the power-off charging method.	The battery pack might be overdischarged. <ol style="list-style-type: none">1. Turn off the computer.2. Make sure that the overdischarged battery pack is in the computer.3. Connect the AC Adapter to the computer and let it charge. If the battery pack cannot be fully charged in 24 hours, use a new battery pack. If a Quick Charger (available as an option) is available, use it to charge the overdischarged battery pack.
The battery operating time indicated by the Fuel-Gauge program or the battery status indicator is much longer or shorter than the actual operating time.	Repeat discharging and charging of the battery pack at least three times.
The operating time for a fully charged battery pack becomes shorter.	Repeat discharging and charging of the battery pack three to six times. If there is still a problem, use a new battery pack.
The computer does not operate with a fully charged battery pack installed.	The over-current protective function in the battery pack might be activated. Turn off the computer for 1 minute to reset the over-current protective function, and then turn it back on again.

CD-ROM Drive Problems

Problem	Action
<p>The CD-ROM will not operate.</p>	<p>Verify that:</p> <ul style="list-style-type: none"> The computer power is turned on and a compact disc is set in the CD-ROM tray. The CD-ROM drive connector is firmly attached to the computer. The CD-ROM drive tray is firmly closed. The device drivers have been installed correctly (see page 147 for OS/2 or page 158 for DOS.) <p><i>When using Windows and DOS, the device driver and support software have been copied to the correct directory on the hard disk. (See page 158.)</i></p> <p><i>When using DOS, the CONFIG.SYS and AUTOEXEC.BAT files have the correct statements (see page 159).</i></p> <p><i>When using DOS, refer to your DOS documentation and check the LASTDRIVE statement in your CONFIG.SYS file. (It is recommended to set the LASTDRIVE to Z.)</i></p>
<p>The compact disc cannot be read.</p>	<p>Verify that:</p> <ul style="list-style-type: none"> The compact disc is not dirty. Clean it with a CD-ROM cleaner kit. The compact disc is not defective. Try another compact disc. The compact disc is placed in the tray with the label side up. The compact disc is a compatible format, as described on page 58.

Troubleshooting



Diskette Drive Problems

Problem	Action
The diskette drive in use icon stays on.	<p>If there is a diskette in the drive, verify that:</p> <ul style="list-style-type: none">– The internal or externally attached diskette drive connector is firmly attached to the computer.– The diskette contains the necessary files to start the system.– There is nothing wrong with your application program.– There is nothing wrong with the diskette. Try a backup copy if you have one.– The diskette is inserted correctly (label up and metal-shutter end first) in the diskette drive. <p>If the preceding items are correct, have the computer serviced.</p> <p>If there is no diskette in the drive, have the computer serviced.</p>

Port Replicator Problems

Problem	Action
The devices attached through the Port Replicator do not work.	<p>Verify that the devices are installed and connected correctly. (Refer to the User's Guide for the Port Replicator.)</p> <p>If the problem remains, remove each device from the Port Replicator and attach each device directly to the computer one at a time. If the device still does not work, have the device serviced. If the device works correctly when attached to the computer, have the Port Replicator serviced.</p>

External Monitor Problems



Problem	Action
<p>The screen is blank.</p>	<p>Verify that:</p> <ul style="list-style-type: none"> The power cord for the external monitor is plugged into a working electrical outlet and into the external monitor. The external monitor is turned on and the brightness and contrast controls are adjusted. The signal cable for the external monitor is plugged into the external-monitor connector on the computer. Some signal cables might not fit into the external-monitor connector because of the connector type. <p>The external monitor (CRT  or Both ) is selected as the display device using the Fn key function (see page 26) or the ThinkPad Features program (see page 33).</p> <p>After verifying the preceding items, turn off the computer; then turn it on.</p> <p>If the external monitor remains blank, run the display tests described in the instructions supplied with the external monitor. If the tests show the external display is OK, have the computer serviced.</p>
<p>The screen is unreadable or distorted.</p>	<p>Verify that:</p> <ul style="list-style-type: none"> The ThinkPad display driver is installed correctly (see Chapter 7). The device setup parameters in the display setting screen (click on the Display ) icon in the ThinkPad Features program) are set to your display resolution and color type (see page 46). <p>To change or set up the external monitor, see “Attaching a Monitor” on page 45.</p> <p>If these are correct, run the tests described in the instructions supplied with the external monitor. If the tests show the external display is OK, have the computer serviced.</p>
<p>Wrong characters appear on the screen.</p>	<p>Verify that the operating systems and application programs have been installed and configured correctly.</p> <p>If so, have the computer serviced.</p>

Troubleshooting

Hibernation Problems

Problem	Action
The computer does not enter hibernation mode with the Fn+F12 key combination.	<p>Did you create the hibernation file?</p> <p>You must create the hibernation file before entering hibernation mode (see page 79).</p> <p>Are you using PC Cards?</p> <p>If you are using one of the IBM communication PC Cards listed in the "Points to Consider When Using Hibernation Mode" on page 81, the computer cannot enter hibernation mode.</p> <p>To enter hibernation mode, stop the communication program, and then remove the PC Card or turn off the power to the PC Card slot using the PC Card Director.</p>

Infrared Communication Problems

Problem	Action
The computer cannot communicate with other devices using the infrared port on the computer.	<p>Verify that:</p> <ul style="list-style-type: none">Power is supplied to the infrared port by the ThinkPad Features program (click on the Infrared () icon).The infrared function is enabled and other choices are set correctly in ThinkPad Features program (click on the Infrared () icon).The communicating device is using an equivalent communication speed (see page 54).The infrared port is clean and does not have any spots.No cable or electrical device is between the computer and the communicating device.The distance and angle between the computer and the communicating device are correct.
Incorrect data is sent between the computer and the device.	<p>Verify that:</p> <ul style="list-style-type: none">The distance and angle between the devices are correct.The communicating device is using an equivalent communication speed.There is no device radiating infrared rays, such as remote-controlled devices or wireless headphones, near the computer or device.Direct sunlight or fluorescent lamps are not near the computer or device.

Keyboard, External Numeric Keypad, and Pointing Device Problems

Problem	Action
<p>All or some keys on the system keyboard do not work.</p>	<p>If the problem occurs immediately after the computer returns to normal operation from suspend mode, enter the power-on password. If a power-on password is set, you must enter the password.</p> <p>If the external keyboard is connected, the numeric keypad on the system keyboard will not work.</p> <p>If the external numeric keypad or the mouse is connected:</p> <ol style="list-style-type: none"> 1. Turn off the computer. 2. Remove the external numeric keypad or the mouse. 3. Turn on the computer and try using the keyboard again. <p>If the keyboard problem is resolved, check the connection of the external numeric keypad, external keyboard, or the mouse. If there is still a problem, have the computer serviced.</p>
<p>The pointer drifts when the computer is turned on or after resuming normal operation. —or— During computer operation, the pointer drifts when not using the TrackPoint III.</p>	<p>Drifting is a characteristic of the TrackPoint III and is not a defect. The drifting occurs for several seconds under the following conditions:</p> <ul style="list-style-type: none"> When the computer is turned on. When resuming normal operation. When the TrackPoint III is pressed for a long period of time. When the environmental temperature changes.
<p>The mouse or pointing device does not work.</p>	<p>Verify that the mouse or pointing-device cable is securely connected to the computer.</p> <p>Try using the TrackPoint III. If the TrackPoint III works, suspect the externally attached pointing device.</p> <p>If you are using Windows 3.11, make sure Computer is set as MS-DOS System with APM. See page 165.</p> <p>If you are using a mouse that is not compatible with the IBM PS/2 Miniature Mouse, disable the TrackPoint III using the ThinkPad Features program.</p> <ol style="list-style-type: none"> 1. For OS/2 and Windows, see page 261 to disable the TrackPoint III. 2. For DOS, see page 36 or page 261.
<p>All or some keys on the external numeric keypad do not work.</p>	<p>Verify that the external numeric keypad is correctly connected to the computer.</p>

Troubleshooting

Problem	Action
All or some keys on the external keyboard do not work.	<p>To use an external keyboard, you need to attach the external input-device connector to the computer. Verify that:</p> <ul style="list-style-type: none"> The external input-device connector is correctly connected to the computer. The keyboard connector is connected to the correct side of the external input-device connector. <p>If the preceding items are correct, disconnect the external input-device connector from the computer and verify that the operation of the system keyboard is correct. If the system keyboard works, have the external input-device connector or the external keyboard serviced.</p>
A number appears when you type an alphabetic character.	The numeric lock function is on. To disable it, press and hold Shift ; then press NumLk .

Option Problems

Problem	Action
An IBM option that was just installed does not work.	<p>Verify that:</p> <ul style="list-style-type: none"> The option is designed for the IBM ThinkPad 365X/365XD computers. The option has been installed correctly by following the instructions supplied with the option or this book. Other installed options or cables are not loose. No I/O address or interrupt level (IRQ) conflict has occurred. To see the system resource status, start the ThinkPad Features program and click on the device icon. (The Advanced... button is available on some devices.) <p>If the test programs for the option did not find the problem, have the computer and option serviced, or see Appendix A.</p>
An IBM option that used to work no longer works.	<p>Verify that:</p> <ul style="list-style-type: none"> All the option hardware and cable connections are securely connected. If the option came with its own test instructions, use those instructions to test the option. System resource conflicts do not occur (see Appendix A). <p>If the preceding items are correct and the test programs did not find the problem, have the computer and option serviced.</p>
The serial port does not work.	Ensure that serial port is enabled and set to COM1 , COM2 , COM3 , or COM4 in the ThinkPad Features program (click on the Serial Port  icon).

PC Card Problems

Problem	Action
<p>PC Card Director does not recognize your PC Card.</p>	<p>Verify that:</p> <p>If you are using the EMS driver under DOS:</p> <ul style="list-style-type: none"> - You have set the correct value for the /MA=mmmm-nnnn parameter in the Resource Map Utility. In the EMS driver, check the UMB area used for PCMCIA under the X=mmmm-nnnn parameter; then use that range to set the /MA parameter in the Resource Map Utility. <p>Your PC Card supports the PCMCIA Release 2.0 and 2.01. Refer to the manual that came with your PC Card.</p> <p>If your PC Card does not support the PCMCIA Release 2.0 and 2.01, you cannot use PC Card Director. Contact your PC Card supplier.</p> <p>Your PC Card is working by following the diagnostic instructions for your PC Card, if any.</p>
<p>The PC Card is recognized by PC Card Director, but the "Not Ready" message is shown.</p>	<p>Verify that:</p> <p>The PC Card enabler is installed.</p> <p>Refer to the manuals supplied with your PC Card.</p> <p>If you are using the EMS driver under DOS:</p> <p>You have set the correct value for the /MA=mmmm-nnnn parameter in the Resource Map Utility. In the EMS driver, check the UMB area used for PCMCIA under the X=mmmm-nnnn parameter; then use that range to set the /MA parameter in the Resource Map Utility. If you are using Windows, also set the value for the EMMEXCLUDE= parameter in the SYSTEM.INI file.</p> <p>The resources for the PC Card are correctly reserved.</p> <p>Refer to "Checking the Allocated Resources for the PC Card" on page 253.</p>

Troubleshooting

Problem	Action
<p>The PC Card is shown as "Ready," but it does not work correctly.</p>	<p>Verify that:</p> <ul style="list-style-type: none"> The resources reserved for the PC Card do not conflict with those for other system devices. Refer to "Avoiding Conflicts When Using PC Cards" on page 232, or open the ThinkPad Features program to resolve a conflict. The resources reserved for the PC Card match the settings in the application program. If you are using a modem card, check the COM number, I/O port address, and IRQ level. If you are using a network card, check the I/O port address, IRQ level, and memory window address. To check the resources assigned to the PC Card, click on the Status button in the PC Card Director program. If you are using an I/O PC Card, it might work if you add the following in the CONFIG.SYS file: <pre>DEVICE=C:\THINKPAD\IBMDSS 1.SYS /IO =x (or /IO1=x)</pre> <p>Note: x shows the PC Card slot number (1 for the upper slot, 2 for the lower slot, or 12 for both slots) on the computer and /IO1= shows the slot number for a Port Replicator that is attached to the computer.</p>
<p>System resource conflicts occurred when using PC Cards.</p>	<p>See "Avoiding Conflicts When Using PC Cards" on page 232.</p>

Printer Problems

Problem	Action
<p>The printer does not work.</p>	<p>Verify that:</p> <ul style="list-style-type: none"> The parallel port is enabled. (Click on the Parallel Port  icon.) The printer is turned on and ready to print. The printer signal cable is connected to the correct connector on the computer. (For the location of the printer connector, see "parallel connector" on page 128.) <p>If the preceding items are correct and the printer still does not work, run the tests described in the printer manual. If the tests show that the printer is OK, have the computer serviced.</p>

Software Problems

Problem	Action
An application program does not work correctly.	<p>To determine if a problem is caused by the software, verify that:</p> <ul style="list-style-type: none">Your computer has the minimum memory required to use the software. Refer to the manuals supplied with the software.The software is designed to operate with your computer and your operating system.Other software works correctly with your computer.Necessary device drivers are installed (see Chapter 7).The software you are using works correctly with another computer. <p>If you have received any error messages when using the application program, refer to the manuals supplied with the software for a description of the messages and a solution to the problem.</p> <p>If the preceding items are correct and there is still a problem, contact your IBM authorized reseller or IBM marketing representative for help.</p>

Getting Service

Getting Service

If you need further assistance, call your IBM authorized reseller or IBM marketing representative.

When requesting service, describe the error message or problem to the service representative. Error messages can help identify what service action is required and help the service representative provide quick and efficient service.

Important

During the warranty period, you may be responsible for repair costs if the product damage was due to misuse, accident, modification, unsuitable physical or operating environment, or improper maintenance by you.

For your convenience, write the service phone numbers here.



Listing Installed Options

When requesting repair service, you might need to know which options you have in your system. Check or write the names of your options below.

DIMM
(8MB or 16MB)
_____MB Hard Disk Drive

Internal CD-ROM Drive
or Diskette Drive

Battery Pack

Port Replicator

PC Cards

Recording Identification Numbers

The following information is needed when requesting repair services:

IBM Product Name	IBM ThinkPad 365X IBM ThinkPad 365XD
Machine Type	_____
Serial Number	_____

The machine type and serial number 1 are located on the bottom of the computer.

The machine type has a prefix of **Type**.
The serial number has a prefix of **S/N**.

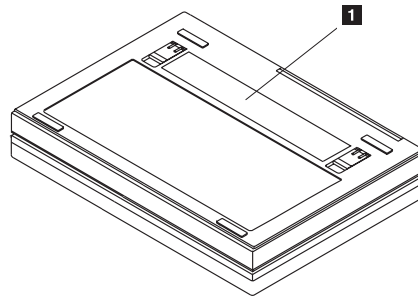

Getting Help, Service, and Information

If you need help, service, technical assistance, or just want more information about IBM products, you will find a wide variety of sources available from IBM to assist you. This section provides information about those sources. Services available and telephone numbers listed are subject to change without notice.

Solving Problems

Many computer problems can be solved without outside assistance, by using the online help or by looking in the online or printed documentation that comes with your computer or software. Also, be sure to read the information in any README files that come with your software.

Most computers, operating systems, and application programs come with documentation that contains troubleshooting procedures and explanations of error messages. The documentation that comes with your computer also contains information about the diagnostic tests you can perform.

If you suspect a hardware problem, run the diagnostic tests and make a note of any error messages you receive. Then look up the message in the documentation and take the appropriate action.

If you suspect a software problem, consult the documentation (including README files) for the operating system or application program.

Using the HelpWare Support Family

IBM *HelpWare* is the **full-service** solution for IBM PC service and support, wherever IBM products are sold and serviced. Purchasing an IBM PC hardware product entitles you to standard, no-fee help and support during the warranty period. If you need additional support and services, HelpWare provides a wide variety of extended solutions that address almost any need.

Getting Help by Telephone

During the warranty period, you can get help and information by telephone, at no additional charge, through the IBM HelpWare PC Support Line. Expert technical-support representatives are available to assist you with questions you might have on the following::

- Setting up your computer and IBM display
- Installing and setting up IBM options purchased from IBM or an IBM reseller
- Using the 60-day support for the preinstalled operating system
- Arranging for service

Please have the following information ready when you call:

- Serial numbers of your computer, display, and other components or your proof of purchase
- Description of the problem
- Exact wording of any error messages
- Hardware and software configuration information for your system

If possible, be at your computer when you call.

In the U.S. and Puerto Rico, call 1-800-772-2227.

In Canada, call 1-800-565-3344.

In all other countries, contact your IBM reseller or IBM marketing representative. See page 224.

These services are available 24 hours a day, 7 days a week (excluding some holidays).

Getting Help, Service, and Information

Your HelpWare representative can also fax or mail additional technical or product information to you, such as:

- Sales information
- Product brochures
- Locations of IBM resellers
- Services available through IBM

ThinkPad EasyServ

ThinkPad *EasyServ* is a courier repair service for IBM Mobile products in which your ThinkPad computer will be picked up, sent to IBM for repair, and then returned to the location of your choice. This service is available at no additional charge during the warranty period. Most repairs should be made the same day the system is received at the IBM repair location.

This service will be arranged by calling the PC Support Line for service. Telephone problem determination will be performed in the event the issue may be resolved over the telephone. If the problem is not able to be resolved over the telephone, a support representative will arrange for ThinkPad EasyServ.

You should keep your original ThinkPad shipping materials to send the computer to the repair location. If the original shipping carton is not available, the courier will deliver a shipping carton and return to pick up the system for delivery to IBM. This service is available only in the U.S. and Canada.

Getting Help Around the World

If you travel with your computer or need to move it to another country, you can register for International Warranty Service. When you register with the International Warranty Service Office, you will receive an International Warranty Service Certificate that is honored worldwide, wherever IBM or IBM resellers sell and service IBM PC products.

For more information or to register for International Warranty Service in the U.S. or Canada, call 1-800-497-7426.

Getting Help, Service, and Information

Online Housecall

Online Housecall is a remote communication tool, available in the U.S. and Canada only, that allows an IBM HelpWare technical-support representative to access your PC by modem. Many problems can be diagnosed remotely and corrected quickly and easily. To use this tool, a modem and a remote access application program are required.

For more information about configuring your PC for Online Housecall:

In the U.S., call 1-800-772-2227.
In Canada, call 1-800-565-3344.

Getting Information by Fax

If you have a touch-tone telephone and access to a fax machine, in the U.S. and Canada you can receive by fax free marketing and technical information on many topics, including hardware, operating systems, and local area networks (LANs). You can call the IBM PC Company Automated Fax System 24 hours a day, 7 days a week. Follow the recorded instructions, and the requested information will be sent to your fax machine.

To access the IBM PC Company Automated Fax System, do the following:

In the U.S., call 1-800-426-3395.
In Canada, call 1-800-465-3299.

Using Electronic Support Services

If you have a modem, you can access public electronic bulletin boards and public messaging areas, electronic conferences, and searchable databases available in several of the most popular online information services.

Getting Help, Service, and Information

Bulletin boards and online services contain information on many topics, such as:

- PC user groups
- PC questions and answers
- OS/2 topics
- Solving problems
- Technical information
- Hardware and software configurations
- Networking

The IBM PC Company Bulletin Board System (BBS) can be reached 24 hours a day, 7 days a week. Modem speeds of up to 14,400 baud are supported. Long distance telephone charges might apply.

To access the PC Company BBS:

- In the U.S., call 1-919-517-0001.
- In Canada, call the center closest to you:
 - Markham: call 905-316-4255.
 - Montreal: call 514-938-3022.
 - Toronto: call 416-492-1823.
 - Vancouver: call 604-664-6466.

Commercial online services that contain information about IBM products include:

CompuServe**

Use the following GO word: ThinkPad.

PRODIGY**

Use the **Jump** command; type `IBM` and select **PC Product Support**.

America Online**

Use the **Go to** keyword **IBM**.

Purchasing Additional HelpWare Services

During and after the warranty period, you can purchase additional HelpWare services, such as support for IBM and non-IBM hardware, operating systems, and application programs; network setup and configuration; upgraded or extended hardware repair services; and custom installations. Service availability and name might vary by country.

Enhanced PC Support Line: Enhanced PC Support is available for desktop and mobile IBM computers that are not connected to a network. Technical support is provided for IBM computers and IBM or non-IBM options, operating systems, and application programs on the Supported Products list.

This service includes technical support for:

- Installing and configuring your out-of-warranty IBM computer
- Installing and configuring non-IBM options in IBM computers
- Using the operating system or application programs
- Tuning performance
- Installing device drivers remotely
- Setting up and using multimedia devices
- Identifying system problems
- Interpreting documentation

You can purchase this service for a single incident, for multiple incidents, or through a 900 number (billing will be by the telephone company). For more information about purchasing Enhanced PC Support, see "Ordering Support Line Services."

Network and Server Support Line: Network and Server Support is available for simple or complex networks made up of IBM workstations and servers using major network operating systems. In addition, many popular non-IBM adapters and network interface cards are supported.

This service includes technical support for:

- Installing and configuring client workstations and servers
- Identifying system problems and correcting problems on the client or the server
- Using IBM and non-IBM network operating systems
- Interpreting documentation

Getting Help, Service, and Information

You can purchase this service for a single incident or for multiple incidents. For more information about purchasing Network and Server Support, see “Ordering Support Line Services.”

PC Software Assistance Support Line: This service is an individual year-long subscription for assistance with desktop application programs installed in IBM and IBM-compatible computers. In Canada, this service is called PC Professional. Product experts will provide telephone assistance, 24 hours a day, 7 days a week, for application programs on the Supported Products list.

For more information about purchasing this service, see “Ordering Support Line Services” on page 221.

Ordering Support Line Services: Enhanced PC Support Line, Network and Server Support Line, and PC Software Assistance Support Line services are available for products on the Supported Products list. To receive a Supported Products list:

In the U.S.,

- Call 1-800-772-2227.
- Select the automated fax system option.
- Select the service for which you would like a Supported Products list:
 - For Enhanced PC Support Line, select document 11682.
 - For Network and Server Support Line, select document 11683.
 - For PC Software Assistance Support Line, select document 11684.

In Canada, contact IBM Direct at 1-800-465-7999, or:

- Call 1-800-465-3299.
- Select the HelpWare catalog.

In all other countries, contact your IBM reseller or IBM marketing representative.

For more information or to purchase these services:

In the U.S., call 1-800-772-2227.

In Canada, call 1-800-465-7999.

In all other countries, contact your IBM reseller or IBM marketing representative.

About Your Warranty

Warranty and Repair Services: You can upgrade your ThinkPad EasyServ/Custom Carry-in warranty service or extend the service beyond the warranty period.

Warranty upgrades in the U.S. include:

Overnight service option

Your warranty provides ThinkPad EasyServ/Carry-in repair service.

You can also extend your warranty. HelpWare Warranty and Repair Services offers a ThinkPad EasyServ Maintenance Agreement.

For more information about warranty upgrades and extensions:

In the U.S., call 1-800-426-7697.

In Canada, call 1-800-465-7999.

In all other countries, contact your IBM reseller or IBM marketing representative.

Consulting: If you want to better understand and more effectively use IBM PC Servers and other Personal Computer products, in the U.S. you can purchase HelpWare Consult Line support. This service offers telephone access to experts for consultation on agreed-to topics. The experts provide recommendations and corrective actions, as appropriate.

For more information about the HelpWare Consult Line, call 1-800-772-2227.

Custom Services

If you are setting up a network and need help installing the network or the application programs, in the U.S. you can purchase assistance from HelpWare Custom Services.

The following services are available:

LAN Startup Services

This service provides assistance with setting up and customizing your network, including:

- Unpacking equipment
- Setting up and testing the hardware
- Connecting systems to LAN cabling
- Customizing the network operating system

Service outside North America

- Customizing the network printer server

Connectivity Services

This service provides hardware installation and connection to support a server and five or more workstations, using token-ring or 10BaseT Ethernet cabling.

For more information about LAN Startup and Connectivity Services, call 1-800-772-2227.

Obtaining IBM Operating System Updates

IBM provides update diskettes, called ServicePaks or corrective service diskettes (CSDs), to customers who report a DOS or OS/2 problem for which there is or will be a corrective program.

You can obtain update diskettes from the following sources:

IBM PC Company BBS.

IBM Software Solutions Center. In the U.S. or Canada, call 1-800-992-4777.

IBM authorized reseller or IBM marketing representative.

Ordering Publications: Additional publications are available for purchase from IBM. For a list of publications available in your country:

In the U.S. and Puerto Rico, call IBM PC Books at 1-800-426-7282.

In Canada, call 1-800-465-1234.

In other countries, contact your IBM authorized reseller or IBM marketing representative.

About Your Warranty

During the warranty period, you may be responsible for repair costs if the product damage was due to misuse, accident, modification, unsuitable physical or operating environment, or improper maintenance.

For complete details about the product warranty, see Appendix E, "Product Warranties and Notices."

Service outside North America

Service outside North America

Notes:

The number in parentheses () is the country code.

Toll-free numbers do not work outside the appropriate country.

Caribbean:

Bahamas	(1)-323-7350
Barbados	(1)-426-0670
Jamaica	(1)-926-3170
Netherlands-Antilles (Curacao)	(599)-77-000
Trinidad	(1)-624-5111

North America:

Canada	Toll-Free 800-565-3344 416-443-1681
Mexico (Mexico City-5)	(52)-557-8588
USA	Toll-Free 800-772-2227 919-517-2477

Central and South America

Argentina (Buenos Aires-1)	(54)-1-313-0014
Chile (Santiago-2)	(56)-2-334-400
Colombia (Bogota-1)	(57)-1-236-1672
Costa Rica	(506)-236-222
Ecuador (Quito-2)	(593)-2-565-100
Panama	(507)-693-977
Peru (Lima-14)	(51)-14-836-1263
Venezuela (Caracas-2)	(58)-2-908-8738

Africa

Angola	(244)-337-591 Sociedade Informatica
(Luanda-2)	(244)-337-598
Botswana	(267)-312-425 Business Computer Ltd
Burundi	(257)-2-25-005 Centre National DeL'Inf

Service outside North America

Burundi	(257)-2-22-813 Computel S.A.R.L SOFT Informatica
Djibouti	(253)-353-444 Dankal Centre Pharma (253)-354-347
Egypt (Cairo-2)	(20)-349-2533
Ethiopia (Addis Ababa-1)	(251)-518-444 AFCOR Ethiopia
Gambia	(22)-27577 Techn. & Office Equipm.
Ghana (Accra-21)	(233)-777-703 Masai Developers Ltd (233)-772-762 (233)-666-201 (233)-666-204
Kenya	(254)-2-230-261/2 Trans Business Mach (254)-2-556-913 Modern Business Mach (254)-2-742-574/5 Genop (BCS Division) (254)-2-742-400/4 (254)-2-750-475
Liberia	(231)-223-648 Liberia Business Mach.
Malawi	(265)-671-755 Comp. Sales & Services
Malta	(356)-234-175 Computer Solutions (356)-234-176 (356)-234-177 (356)-233-121
Mozambique	(258)-424-036 Systems & Computadores
Nigeria (Lagos-1)	(234)-1-633-194 (234)-1-634-473 (234)-1-634-453 (234)-1-630-371 (234)-1-632-739
Rwanda	(250)-72-931 Compulec Rwanda

Service outside North America

Sierra Leone	(232)-22-224-275 Continental Comm. & Service (232)-22-223-833
South Africa	(27)-011-331-8111 Toll-Free 0800-110756
Sudan	(249)-40-296 Computer Ltd (249)-42-277
Tanzania (Dar Es Salaam-51)	(255)-51-37-183 Intern. Comm. Syst. (255)-51-32-810
Uganda (Kampala-41)	(256)-41-230-823 Business Systems Ltd
Zaire (Kinshasa-12)	(243)-12-24-029 Zaire Business Mach. (243)-12-23-359
Zambia (Lusaka-1)	(260)-1-229-323 Woodgate Computer Sys. (260)-1-229-325 (260)-1-221-182
Zimbabwe (Harare-4)	(263)-4-794-631 Infotech Ltd
Europe and Middle East	
Abu Dhabi	971-2-337-173 Alpha Data Proc. Ser.
Austria	(43)-222-21145-7500
Bahrain	973-2-531-585 Mohammed Jalal & Sons
Belgium	(32)-2-718 4333
Bosnia-Herzegovina	(38)-71-219388
Bulgaria	(359)-2-730235
Croatia	(30)-41-624500
Czech Republic	(42)-2-7106111
Denmark	(45)-43-43-43-43
Dubai	971-4-521-000 Al-Abbas Trad. Co.
Finland	(358)-0-9800 4260
France	(33)-1-4039-9798
Germany (Hannover)	(49)-(0)-130-4567 (49)-(0)-511-5164567

Service outside North America

Greece	(30)-1-995-3403
Hungary	(36)-1-1654422
Iceland	Toll-Free 354-1-996977
Iran	982-1-893-251 Data Processing Iran 982-1-680-644 Data Proc. Field Eng. 982-1-850-504 Daya Systems Co. 982-1-858-947 Taradis Iran Comp. 982-1-651-319 Iran Microsyste
Ireland	(353)-1-515-811
Israel (Tel Aviv-3)	(972)-3-618-681
Italy	(39)-2-28100327 (39)-2-28100370
Jordan	962-6-603-879 General Comp. & Elec. 962-6-605-365 962-6-664-221 Special Systems Co.
Kuwait	965-2-451-915 Al Khorafi
Lebanon	961-1-324-122 Commercial & Tech. Sup. 961-1-336-719 961-1-372-860/1 El-Haceb S.A.L. 961-1-389-814
Macedonia	(38)-91-117022
Netherlands	(31)-20-513-4275
Norway (Oslo)	(47)-66 99 93 00
Oman	968-793-741 Suhail & Saud Bahwan
Pakistan	(92)-21-525-181
Poland (Warsaw)	(48)-2-6582991
Portugal (Lisbon-1)	(351)-1-795-5546
Qatar	974-435-395 Almana Company
Romania	(40)-1-6158267
Russia	(7)-095-2356602
Saudi Arabia	(966)-2-660-0007 Saudi Business Mach.

Service outside North America

	(966)-2-669-4605 S.B.M. Inf. Products
	(966)-2-761-7285 Tayseer Al Sheikh
	(966)-2-665-3470 Saudi Soft
Serbia	(38)-11-34622211
Slovak Republic	(42)-7-330175
Slovenia	(38)-61-15215
Spain (Madrid-1)	(34)-1-397-6503
Sweden	(46)-8-793 30 00
Switzerland	(41)-155-46-46
Syria	963-11-249-911 Attar Brothers Trad.
Turkey (Istanbul-1)	(90)-1-800-900
United Kingdom	(44)-81-940-6001
Yemen	967-2-272-401 Khirbash & Majid Trad.
Middle East	973-2-10880 Gulf Business Mach. Abu Dhabi Dubai Kuwait Oman (Bahrain) Bahrain Jordan Lebanon Qatar

Asia and Pacific Countries

Australia (Sydney-2)	(61)-2-951-9716
Bangladesh	(880)-2-863532
Brunei	(673)-3-35204
Burma	See Myanmar
Hong Kong	(852)-825-6345
India	(91)-812-562645
Indonesia	(62)-21-571-1455 (62)-21-571-1485 (62)-21-571-1555 (62)-21-571-1575 (62)-21-520-9500
Japan	Toll-Free 0120-20-5550 03-3450-7744 (fax)
(Tokyo)	(81)-3-3586-1111
Korea	Toll-Free 080-023-5050

Service outside North America

	(82)-2-781-7367
Malaysia	(60)-3-735-5727 (60)-3-735-5728
Myanmar (Burma)	(95)-01-78354 (95)-01-73951
New Zealand	Toll-Free 0800-733-222 (64)-4-576-5555
Philippines	(63)-2-819-3679 (63)-2-819-3774 (63)-2-816-3578
Singapore	(65)-289-8973 (65)-289-8975 (65)-289-2101 (fax)
Sri Lanka	(94)-1-448442 (94)-1-440810-203
Taiwan	Toll-Free 080-21-1212 (886)-02-776-7676
Thailand	(66)-2-2734069-70 (66)-2-27344010

For other countries, contact your local IBM office for service information.

Appendix A. Avoiding Hardware Conflicts

This appendix describes how to avoid system resource conflicts by listing the default and optional hardware settings. It also describes how to do a network remote program load and how to start the computer from an ATA PC Card.

For PC Card resource conflicts, see “Avoiding PC Card Resource Conflicts” on page 255.

Avoiding System Resource Conflicts

When a new option such as an adapter card is installed, the computer might not operate correctly because of conflicting settings for IRQ (interrupt) levels, I/O addresses, DMA channels, and memory addresses.

To avoid these resource conflicts, you must know the hardware requirements, such as IRQ level and I/O addresses, for each option and program as shown in their manuals.

Then you must check the current resource allocations for the computer and your expansion unit, and select the available resource values by using the ThinkPad Features program.

ThinkPad Features program:



Page 33.

Example:



When you want to install a new Ethernet PC Card in the computer, you need to assign an IRQ for the PC Card. An Ethernet PC Card generally requires IRQ5 as a default interrupt level; however, IRQ5 has already been occupied by the ESS AudioDrive function in the computer.

You need to disable the ESS AudioDrive function when you use the Ethernet PC Card as follows:

- 1** Install the Ethernet PC Card in the PC Card slot.
- 2** Open the ThinkPad Features program and click on the **PC Card** () icon.
- 3** Click on the **Auto Config** button.

Avoiding Hardware Conflicts

The ESS AudioDrive function is automatically disabled by the ThinkPad Features program, and the Ethernet PC Card is now ready to use.

When you want to disable the Ethernet PC Card and enable the ESS AudioDrive function, open the ThinkPad Features program, click on the **Audio** ( or ) icon; then click on the **Advanced** button. You can enable ESS AudioDrive at the Audio/Alarm Advanced Setup screen.

Avoiding Conflicts When Using PC Cards

When you do a network remote program load (RPL) or start the computer from a PC Card, you must make sure that the system resources used by the PC Card do not conflict with the resources used by other devices.

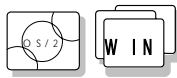

Using the ThinkPad Features Program: When PC Card resources conflict with a built-in device, you can resolve the conflict using the ThinkPad Features program:

- 1** Insert the PC Card into the PC Card slot.
- 2** Start Windows or OS/2.
- 3** Start the ThinkPad Features program.
- 4** Click on the **PC Card** () icon.
- 5** Click on the **Auto Config** button.
- 6** Exit the ThinkPad Features program and restart your computer.

The built-in device in conflict may have been disabled to resolve the resource conflict.

Avoiding Hardware Conflicts

If you are using Windows, you can set the memory area used by the PC Card as follows:

- 1** Start the PC Card Director.
- 2** Select **Set Memory Area...** from the Actions pull-down menu.

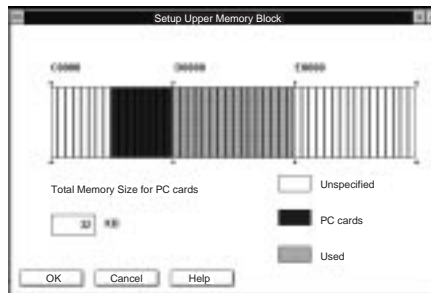

- 3** Plan carefully which memory area to use for the PC Card and Card Services from the displayed information.
- 4** Using the mouse pointer, click on the desired memory area for the PC Card.
- 5** Click on the **OK** button.
- 6** Restart the computer.

Avoiding Hardware Conflicts

Doing a Network Remote Program Load

To do a network remote program load (RPL):

- 1** Using the PS2 command or ThinkPad Features program, check that there is no conflict between the system resources used by the PC Card and by other devices.

The following are the resources for a token-ring PC Card and an Ethernet PC Card:

Token-Ring PC Card

IRQ 9
I/O Address (Hex) 0A20–0A23
Memory Address (Hex) D6000–D7FFF, D8000–DBFFF

Ethernet PC Card

IRQ 5
I/O Address (Hex) 0300–031F
Memory Address (Hex) D2000–D3FFF, D4000–D7FFF

IRQ5 is the default setting used by the Sound Blaster emulation. To do an Ethernet PC Card RPL, change the IRQ for the Sound Blaster emulation, or disable it with the ThinkPad Features program or the **SB** PS2 command (see page 261).

- 2** Start Easy-Setup and select the **Start Up** icon.
- 3** Select the **Network** icon.
A window appears at the bottom of the screen for you to select the RPL speed.
- 4** If you are using a token-ring card, select **4** (4Mbps) or **16** (16Mbps) for the RPL speed.
- 5** Click on **OK** or press **Enter**; then restart the computer.

Avoiding Hardware Conflicts

Starting the Computer from an ATA PC Card

To start the computer from an ATA PC Card:

- 1** Using the PS2 command or ThinkPad Features program, check that there is no conflict between the system resources used by the PC Card and by other devices.

The following are the resources for an ATA PC Card:

IRQ	15
I/O Address (Hex)	0170–0177

Note

If you install the IDE hard disk or CD-ROM drive in the Port Replicator, IRQ15 is the default setting used by the IDE hard disk or CD-ROM drive. Remove the IDE hard disk or CD-ROM drive to use an ATA PC Card.

- 2** Start Easy-Setup and select the **Start Up** icon.
- 3** Select the **PCMCIA** icon.
The PC Card (PCMCIA icon) should not be set to follow the computer hard disk drive (**HDD-1** icon) in the list. If the **HDD-1** icon is already in the drive-startup sequence, click on the **Reset** icon; then set the sequence so that the PC Card icon is before the **HDD-1** icon.
- 4** Click on **OK** or press **Enter**; then restart the computer.

Avoiding Hardware Conflicts

List of System Resources

The following table summarizes the available system resources for the computer and expansion units. Values in parentheses are alternative values that are selectable in the ThinkPad Features program or application programs. The default values are highlighted.

System Resources	IRQ	I/O Address (Hex)	Memory Address (Hex)	DMA Channel
Timer	0	0040–0043	None	None
Keyboard	1	0060 and 0064	None	None
Serial Port	Disabled	Disabled	None	None
	4	03F8–03FF		
	3	02F8–02FF		
	4	03E8–03EF		
	3	02E8–02EF		
Parallel Port	7	03BC–03BE (and 07BC–07BE)	None	0, 1, 3, or disabled
	7	0378–037F (and 0778–077A)		
	5	0278–027F (and 0678–067A)		
	Disabled	Disabled		
Infrared Port	4, 3, or disabled	03F8–03FF , 02F8–02FF, 02E8–02EF, or 03E8–03EF	None	0 and 3 or disabled
Diskette Controller	6	03F0–03F7	None	2
Video Controller	None	03BA, 03B4–03B5, 03C0–03CF, 03D4–03D5, 03D8–03D9, 03DA, 2100–21FF, 43C6–43C9, 46E8, and 83C6–83C9	A0000–BFFFF and C0000–C7FFF	None
ESS AudioDrive Device (Sound Blaster)	5, 7, 10, 11, or disabled	0220–022F or 0240–024F	None	1 or 0
ESS AudioDrive Device (FM Synthesizer)	None	0388–038B	None	None
MIDI Port (on Port Replicator)	5, 7, 10, 11, or disabled	0330–0332 or 0300–0302	None	None
Joystick Port (on Port Replicator)	None	0201	None	None

Avoiding Hardware Conflicts

System Resources	IRQ	I/O Address (Hex)	Memory Address (Hex)	DMA Channel
Hard Disk Drive or CD-ROM Drive (for the 365XD)	14	01F0–01F7 and 03F6–03F7	None	None
PCMCIA Controller	None	03E0–03E1	None	None
PC Card	(Depends on the type of PC Card)	(Depends on the type of PC Card)	(Depends on the type of PC Card)	None
Real Time Clock	8	0070–0071	None	None
TrackPoint III or Mouse	12	0060 and 0064	None	None
Math Coprocessor Exception	13	None	None	None
<p>Notes:</p> <ol style="list-style-type: none"> 1. ESS AudioDrive, Sound Blaster, and the MIDI connector (on the Port Replicator) share the same IRQ. 2. Addresses in the parentheses are also used when ECP is enabled by the ThinkPad Features program as the printer operating mode. 3. When you enable ECP as the printer operating mode by ThinkPad Features program, one of the choices (including "disabled") must be selected. 				

Avoiding Hardware Conflicts

Appendix B. Advanced Information for PC Cards

This appendix describes advanced information related to using PC Cards.

Auto Configurator for PC Card Director

Note:

When installing an operating system, install the PCMCIA device driver that is on the PCMCIA Features Diskette to use the Auto Configurator.

To install the PCMCIA device driver:



Chapter 7.

The 365X and 365XD computers provide the *Auto Configurator*, a program for some PC Cards, so that you do not have to install the device driver supplied with the card to use it.

The resource and configuration information for the PC Cards are written in the script files. Once the information is written, you can use the *Auto Configurator Utility* to edit these script files.

When Auto Configurator is installed, the following line is added to the CONFIG.SYS file according to your operating system:

For OS/2:

```
BASEDEV=AUTODRV2.SYS
```

For DOS and Windows:

```
DEVICE=[drive:] [directory] AUTODRV.SYS
```



Starting the Auto Configurator Utility for OS/2 or Windows

This section describes the Auto Configurator Utility for OS/2 or Windows.

To start Auto Configurator Utility for OS/2 or Windows, select the **Auto Configurator Utility** icon from the PC Card Director window.



The operation for OS/2 and for Windows is the same.

Advanced Information for PC Cards

Registering a PC Card in Auto Configurator

- 1 Select a card from the Available Cards list in the Auto Configurator Utility main panel.

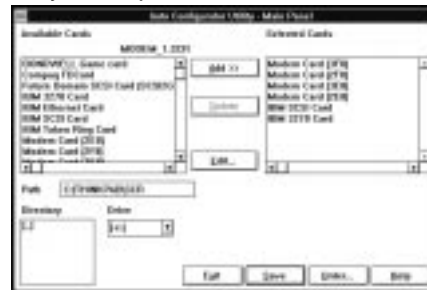

Select the card for which you want to assign the resources first. For example, to assign COM3 to a modem card, and not COM2, select the setting for COM3 first.

- 2 Click on the **Add>>** button.
- 3 Click on the **Save** button.

The names in the left list box (**Available Cards**) are the cards that can be registered. Those in the right list box (**Selected Cards**) are already registered in Auto Configurator. When a PC Card is installed, Auto Configurator starts from the top of the list to assign the resources to the card.

Deleting a Registered Card

- 1 Select the PC Card you want to delete from **Selected Cards** in the Auto Configurator Utility main panel.
- 2 Click on the **Delete** button.
- 3 Click on the **Save** button.

Advanced Information for PC Cards

Changing the Registered Order for PC Cards

To change the order of the registered PC Cards, do the following:

- 1 Click on the **Order...** button in the Auto Configurator Utility main panel.



The operation for OS/2 and for Windows is the same.

- 2 Refer to the following to change the order of the PC Cards in the list:
 - Moving a card toward the bottom:
 - a) Select the PC Card you want to move.
 - b) Click on the **Down** button. Every time you click on the **Down** button, the PC Card is moved toward the bottom of the list.
 - Moving a card toward the top:
 - a) Select the PC Card you want to move.
 - b) Click on the **Up** button. Every time you click on the **Up** button, the PC Card is moved toward the top of the list.
- 3 Click on the **OK** button to save the changes. The changes are saved. To cancel the changes, click on the **Cancel** button.

Advanced Information for PC Cards

Changing the Resource Information for the PC Card

1 Select the PC Card you want to change from the left list box in the Auto Configurator Utility main panel.

2 Click on the **Edit...** button.

The following screen is displayed:

Note:

The current resource information is set as the default and appears in the input field of each item. The number that can be set is displayed in the pull-down list box.

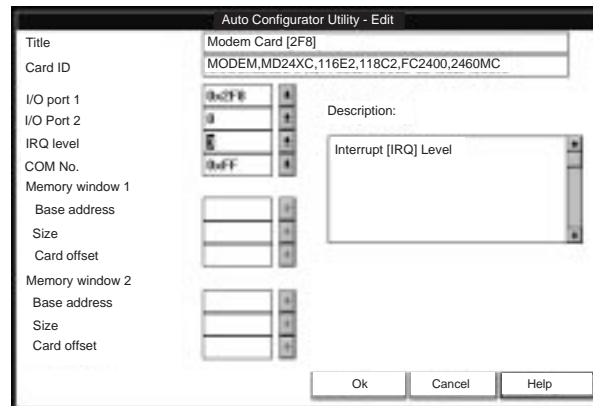

3 You can change the following registered information for the PC Card.

The items that can be changed differ among PC Cards.

- Card ID
- I/O port address
- IRQ level
- COM number of the serial port
- Memory window address
- Memory window size
- Card offset address

4 Click on the **OK** button, and save the changes.

To cancel the changes, click on the **Cancel** button.

Adding to the CONFIG.SYS File

For PC Card Director to work correctly, the PC Card device drivers (which make up the structured file of PC Card Director) must be registered in the CONFIG.SYS file. These drivers are automatically registered in the CONFIG.SYS file when you install PC Card Director following the instructions in Chapter 7. The following shows each driver registered in the CONFIG.SYS file and the standard rules.



Registered Drivers and Standard Rules for OS/2

The following is a sample of the CONFIG.SYS file for OS/2:

```

:
BASEDEV=PCMCIA.SYS           ← Card Services
BASEDEV=ICRMU 1.SYS         ← Resource Map Utility
BASEDEV=IBM2SS 1.SYS        ← Socket Services
BASEDEV=AUTODRV2.SYS        ← Auto Configurator
DEVICE=C:\THINKPAD\VPCMCIA.SYS ← Virtual Card Services
:
DEVICE=C:\THINKPAD\xxxxxxx.SYS
:                               ↑ Storage card device driver
REM PC_Card_Client_Device_Driver
:
DEVICE=C:\THINKPAD\$\ICPMOS2.SYS
                               ↑ Power Management Support driver

```

- Rule 1** Card Services, Resource Map Utility, and Socket Services must be listed before any other PCMCIA drivers.
- Rule 2** The Resource Map Utility is necessary only for OS/2 Version 2.1x.
- Rule 3** The PCMCIA Power Management Support driver must be listed after all drivers, at the end of the CONFIG.SYS file.
- Rule 4** When using storage cards, the device drivers must be installed according to the card type:

Advanced Information for PC Cards

Using only an ATA card:

```
:
BASEDEV=PCM2ATA.ADD /!DM ← ATA card device driver
DEVICE=C:\THINKPAD\PCMSSDIF.SYS
:
↑ Storage API device driver
BASEDEV=OS2PCARD.DMD ← Storage Card Device Manager
```

Using an ATA card and an SRAM card:

```
:
BASEDEV=PCM2ATA.ADD /!DM ← ATA card device driver
DEVICE=C:\THINKPAD\PCMSSDIF.SYS
↑ Storage API device driver
DEVICE=C:\THINKPAD\PCM2SRAM.SYS
:
↑ SRAM card device driver
BASEDEV=OS2PCARD.DMD ← Storage Card Device Manager
```

Using an ATA card and a Flash card:

```
:
BASEDEV=PCM2ATA.ADD /!DM ← ATA card device driver
DEVICE=C:\THINKPAD\FLSH2MTD.SYS
↑ Flash Card Memory
Technology driver
DEVICE=C:\THINKPAD\PCMSSDIF.SYS
↑ Storage API device driver
DEVICE=C:\THINKPAD\PCM2FLSH.SYS
:
↑ Flash card device driver
BASEDEV=OS2PCARD.DMD ← Storage Card Device Manager
```

Using an ATA card, an SRAM card, and a Flash card:

```
:
BASEDEV=PCM2ATA.ADD /!DM ← ATA card device driver
DEVICE=C:\THINKPAD\FLSH2MTD.SYS
↑ Flash Card Memory
Technology driver
DEVICE=C:\THINKPAD\PCMSSDIF.SYS
↑ Storage API device driver
DEVICE=C:\THINKPAD\PCM2SRAM.SYS
↑ SRAM card device driver
DEVICE=C:\THINKPAD\PCM2FLSH.SYS
:
↑ Flash card device driver
BASEDEV=OS2PCARD.DMD ← Storage Card Device Manager
```

Advanced Information for PC Cards

- Rule 5** The Storage Card Device Manager (OS2PCARD.DMD) must be added after the Power Management Support driver (\$ICPMOS2.SYS) in the CONFIG.SYS file. If you don't have the Power Management Support driver, the Storage Card Device Manager must be added at the end of the CONFIG.SYS file.



Registered Drivers and Standard Rules for DOS and Windows

The following is a sample of the CONFIG.SYS file for DOS and Windows:

```
      :
DEVICE=C:\DOS\EMM386.EXE FRAME=D      X=C8  -CFFF
      :
DEVICEHIGH=C:\THINKPAD\IBMDSS 1.SYS ← Socket Services
DEVICEHIGH=C:\THINKPAD\IBMDOSCS.SYS ← Card Services
DEVICEHIGH=C:\THINKPAD\DICRMU 1.SYS /MA=C8 -CFFF
                                ↑ Resource Map Utility
DEVICEHIGH=C:\THINKPAD\$_ICPMDOS.EXE
                                ↑ Power Management Support driver
      :
REM PC_Card_Client_Device_Driver
      :
DEVICEHIGH=C:\THINKPAD\xxxxxxx.SYS
                                ↑ Storage card device driver
DEVICEHIGH=C:\THINKPAD\AUTODRV.SYS ← Auto Configurator
      :
```

- Rule 1** When using the PCMCIA drivers with the Software EMS driver (EMM386.EXE), you must specify the X= parameter for EMM386.EXE. This is to avoid conflict in the memory area used by the PCMCIA drivers and the Software EMS driver.
- Rule 2** Socket Services, Card Services, and Resource Map Utility must be listed in this order.
- Rule 3** The Power Management Support driver must be listed after the Resource Map Utility.
- Rule 4** The PC Card Client device driver must be listed before the Auto Configurator.
- Rule 5** When using storage cards, you must install the device driver according to the card type, as listed below.

Using only an ATA card:

```
DEVICEHIGH=C:\THINKPAD\PAWATA.SYS
```

Using an ATA card and an SRAM card:

```
DEVICEHIGH=C:\THINKPAD\PAWATAS.SYS
```

Advanced Information for PC Cards

Using an ATA card, an SRAM card, and a Flash card:

```
DEVICEHIGH=C:\THINKPAD\FLSHDMTD.SYS
          ↑ Flash card
          Memory Technology driver
DEVICEHIGH=C:\THINKPAD\PAWATASF.SYS
          ↑ ATA SRAM
          Flash card driver
```

Note: When the total storage of the Flash cards used at the same time exceeds 10 MB, you must do one of the following:

Assign the `/TSIZE:n` parameter in the PAWATASF.SYS file.

For example:

1. If the maximum total storage is 20MB, specify:

```
DEVICE=PAWATASF.SYS /TSIZE:6
```

2. If the maximum total storage is 40MB, specify:

```
DEVICE=PAWATASF.SYS /TSIZE:1
```

See the `/TSIZE` parameter on page 251.

This increases the memory-resident area for PAWATASF.SYS.

Assign the `/EMS` parameter in the PAWATASF.SYS file, and the `/NE` parameter in the IBMDOSCS.SYS file. This sets IBMDOSCS.SYS not to use the EMS page frame and allows PAWATASF.SYS to use it instead. (The EMS memory must be enabled.)

For example:

```
DEVICE=IBMDOSCS.SYS /NE /FLASH
:
DEVICE=PAWATASF.SYS /EMS
```

Storage Card Device Driver

ATA cards, SRAM cards, and Flash cards are PCMCIA storage cards. The following section describes the device drivers for these storage cards, available in PC Card Director.



PCMCIA Storage Card Device Driver for OS/2

Note:
Install PCM2ATA.ADD for all storage cards, even when you are using SRAM or Flash cards.

PCM2ATA.ADD supports ATA cards, PCM2SRAM.SYS supports SRAM cards, and PCM2FLSH.SYS supports Flash cards.

Any PC Card installed in the slot is recognized by its device driver, so regardless of its type, you can access the card by the drive name assigned to the slot.

When using the PCMCIA ATA Card Mount Utility, install the PCMCIA Storage API device driver (PCMSSDIF.SYS) for OS/2.



PCMCIA Storage Card Device Driver for DOS and Windows

PAWATA.SYS supports ATA cards, PAWATAS.SYS supports ATA cards and SRAM cards, and PAWATASF.SYS supports ATA cards, SRAM cards, and Flash cards.

These device drivers assign a drive letter for each usable PC Card slot. These drive letters are displayed when the device drivers are initialized, and then you can use the drive letter to access the installed PCMCIA storage card. When you run FORMAT.COM against the drive letter, the SRAM card is formatted as a diskette and the ATA or Flash card is formatted as a nonremovable disk. In the File Manager under Windows, the drive letters are represented and treated as a diskette drive, regardless of the storage card type.

Before Using PCMCIA Storage Cards

Format new PCMCIA storage cards before use. For Flash cards, run the Flash Format Utility (FFORMAT.EXE/FFORMAT2.EXE); then format the Flash card. For ATA cards and SRAM cards, there is no need to run any programs before formatting the card. Format using the FORMAT.COM program, by displaying the File Manager (for Windows), or by choosing the drive icon (for OS/2).

Using PCMCIA ATA Cards with Multiple Partitions

The device driver assigns a drive letter only to the active (bootable) partition of the ATA card if it holds multiple partitions. For other primary partitions or logical drives in an extended partition, use the PCMCIA ATA Card Mount utility to assign the drive letter to it.



Parameters for the OS/2 PCMCIA ATA Card Device Driver

The following are the parameters in the OS/2 PCMCIA ATA card device driver and their explanations:

```
BASEDEV=PCM2ATA.ADD [/S:n] [/P:hxxx] [/EXIRQ:n]  
[/NOBEEP] [/B] [/STBTIME:n] [/MDRV:n] [!/DM]
```

- /S:n** Specifies the number of PC Card slots. /S:1 shows that there is only one PC Card slot. When this parameter is not set, the number of PC Card slots is set to 2.
- /P:hxxx** Specifies the lower limit for the I/O address of the ATA card. The device driver assigns the next usable I/O address from this lower limit to the card. When this parameter is not set, the device driver looks for a usable address and assigns it to the card.
- /EXIRQ:n** Specifies the IRQ level that *is not* assigned to the card. You can set more than one IRQ level.
- /NOBEEP** Specifies not to beep when a storage card is installed. When this parameter is not set, you will hear a beep every time a storage card is installed into the PC Card slot.
- /B** Specifies that OS/2 has started from an ATA card. When this parameter is set, there will be no redundancy in assigning the logical drive to the slot where OS/2 was booted. It depends on the ATA card whether you can start OS/2 from it.
- /STBTIME:n** Specifies the time (from 1 to 21 minutes) until entering standby mode. When the ATA card is not accessed for the time specified by this parameter, the ATA card enters standby mode (only when your ATA card supports standby mode). When this parameter is not specified, standby mode for the ATA card is disabled.

Advanced Information for PC Cards

- /MDRV:n** Specifies the number of extra drives that can be used in addition to the number of PC Card slots available for the PCMCIA storage devices. When this parameter is not specified, no extra drive is given to the device driver. The extra drives can be activated by the PCMCIA ATA Card Mount utility.
- /IDM** Specifies not to use OS2DASD.DMD as the device manager. When this parameter is set, OS2PCARD.DMD is used instead.



Parameters for DOS PCMCIA Storage Card Device Drivers

The following are the parameters in the DOS PCMCIA storage card device driver and their explanations:

```
DEVICE=[drive:] [directory] PAWATA.SYS [/P:hhhh] [/NOBEEP]
      [/STBTIME:n] [/MDRV:n]
DEVICE=[drive:] [directory] PAWATAS.SYS [/P:hhhh] [/NOBEEP]
      [/STBTIME:n] [/MDRV:n]
DEVICE=[drive:] [directory] PAWATASF.SYS [/P:hhhh]
      [/NOBEEP] [/STBTIME:n] [/MDRV:n] [/EMS] [/TSIZE:n]
```

- /P:hhhh** Specifies the lower limit for the I/O address of the ATA card. The device driver assigns the next usable I/O address from this lower limit to the card. When this parameter is not set, the device driver looks for a usable address and assigns that address to the card.
- /NOBEEP** Specifies not to beep when a storage card is installed. When this parameter is not set, you will hear a beep every time a storage card is installed into the PC Card slot.
- /STBTIME:n** Specifies the time (from 1 to 21 minutes) until entering standby mode. When the ATA card is not accessed for the time specified by this parameter, the ATA card enters standby mode (only when your ATA card supports standby mode). When this parameter is not specified, standby mode for the ATA card is disabled.
- /MDRV:n** Specifies the number of extra drives that can be used in addition to the number of PC Card slots available for the PCMCIA storage devices. When this parameter is not specified, no extra drive is given to

Advanced Information for PC Cards

the device driver. The extra drives can be activated by the PCMCIA ATA Card Mount Utility.

/EMS When this parameter is specified, the device driver uses the EMS resources if they are usable. When this parameter is not specified, the device driver does not use the EMS resources.

/TSIZE:n You can specify the size of the table for the device driver data in the resident memory area. When the EMS resources are not usable, the data tables are created in the resident memory area. When the EMS resources are usable, this parameter is ignored. The table size depends on the variable *n* and is calculated as follows:

$$\text{table size} = n \times 1024 \text{ bytes}$$

Specify *n* in a decimal number. When this parameter is not specified, the device driver creates the table with *n*=4. Select the variable *n* depending on the total capacity of the Flash card. The following is an example of the relationship between the variable *n* and the total capacity of the Flash card:

Up to 10MB: *n*=4
Up to 20MB: *n*=6
Up to 40MB: *n*=10



PCMCIA Storage Card Device Manager for OS/2

OS2PCARD.DMD is the device manager for the PCMCIA storage card. Specify the `!/DM` parameter in the `PCM2ATA.ADD` line, so OS2PCARD.DMD is used instead of OS2DASD.DMD. If you do not specify `!/DM`, PCM2ATA.ADD uses the OS/2 standard Storage Card Device Manager (OS2DASD.DMD); however, under some conditions the format is not correct when you use OS2DASD.DMD.

The following is a line from the CONFIG.SYS file that describes the Storage Card Device Manager:

```
BASEDEV=OS2PCARD.DMD
```



OS/2 PCMCIA Storage API Device Driver

This device driver provides a communication function between PC Card Director or the mount utility and the OS/2 PCMCIA ATA card device driver. As a result, a utility in the upper layer can get the drive letter or partition information for the PCMCIA storage card.

The following is a line from the CONFIG.SYS file that describes the Storage API device driver:

```
DEVICE =[drive:][directory]PCMSSDIF.SYS
```

Flash Card Memory Technology Driver

This driver is used to read and write to a Flash card. It is used by the DOS storage card device driver (PAWATASF.SYS) and OS2 Flash card driver (PCM2FLSH.SYS).

The following is a line from the CONFIG.SYS file that describes the Flash Card Memory Technology driver, according to the operating system:

For OS/2:

```
DEVICE =[drive:] [directory] FLSH2MTD.SYS
                                     ↑ Memory Technology driver
DEVICE =[drive:] [directory] PCM2FLSH.SYS
                                     ↑ Storage card device driver
```

For DOS and Windows:

```
DEVICE=[drive:] [directory] IBMDOSCS.SYS /FLASH
                                     ↑ Card Services driver
DEVICE=[drive:] [directory] FLSHDMTD.SYS
                                     ↑ Memory Technology driver
DEVICE=[drive:] [directory] PAWATASF.SYS
                                     ↑ ATA SRAM Flash card
                                     device driver
```

Checking the Allocated Resources for the PC Card

If the resources for the PC Cards are not correctly allocated, you will see error messages. You can check which resources for the PC Card were not correctly allocated by using PC Card Director. To check the resources that could not be allocated, click on the **Status** button in the PC Card Director program.

The following are some reasons why the resources could not be correctly allocated, and corresponding actions you should take to solve the problem.

The resource was already reserved by another device.
Resource Map Utility or other configuration files were not set up correctly.

To change the resource settings for the PC Card or other devices, you can do one of the following:

Refer to the system manual or utility program and check which device is using the resources that you want to use for the PC Card. Then, change the settings for the device by using, for example, the setup programs. For more information, refer to the manuals supplied with your computer.

If your PC Card is enabled by a PC Card enabler, you can change the resources assigned to the PC Card by changing the parameters in the PC Card enabler, or you can change the settings in the configuration file of the PC Card. For more information, refer to the manuals supplied with your PC Card.

Advanced Information for PC Cards

If you are using Auto Configurator to enable your PC Card, you can change the resources assigned to the PC Card by using the Auto Configurator. Make sure the resource is not used by other devices and can be used by the PC Card and its application program. For more information, see "Starting the Auto Configurator Utility for OS/2 or Windows" on page 239.

If you are using modem cards, some modem cards use serial port COM1 or COM2 and do not have the setup information for COM3 and COM4. These modem cards cannot be enabled when other devices are using COM1 and COM2. Error messages are displayed to tell you that the I/O port address 3F8 or 2F8, or IRQ level 3 or 4, were not allocated.

If this is the case, use the ThinkPad Setup Utility in the ThinkPad Features program to:

- For OS/2, disable the devices using COM1 or COM2; then restart the system.
- For DOS or Windows, reserve COM2 for the PC Card, and use COM1 for other integrated communication devices.

Avoiding PC Card Resource Conflicts

PC Card Director checks the resources for most devices used by the system to avoid resource conflicts, but it does not recognize all option devices used. Especially when you are using the expansion unit, there is a possibility that the I/O port address or IRQ level may conflict with the PC Card.

Check the status of the PC Card by using PC Card Director. When the PC Card is set to "Ready," the resources used for that PC Card are displayed. Refer to the manuals supplied with the system or option adapters to check that the resources for the devices in the system or for the option adapters are not conflicting with the resources for the IRQ level, I/O port address, or memory window of the PC Card. If you are using OS/2 Warp Version 3, you can check the assigned system resources using RMVIEW.EXE.

If there is a conflict:

Use the Resource Map Utility, so that those resources are not assigned to the PC Card. (Change the value for the /MA= parameter, or add the /MX=, /PX=, or /IX= parameter.)

If you are using OS/2 Warp Version 3, use RESERVE.SYS to register those resources in OS/2.

To set RESERVE.SYS, refer to the manuals or online help for OS/2 Warp, or refer to the READ.ME file of PC Card Director.

If you are using Auto Configurator, change the enabling order or resource information using the Auto Configurator Utility.

See "Starting the Auto Configurator Utility for OS/2 or Windows" on page 239.

Change the parameter for the PC Card enabler. Refer to the manuals supplied with the PC Card.

If you are using network cards, change the resource information for the PC Card stated in the PROTOCOL.INI or NET.CFG file.

To change the configuration file for the network cards, refer to the manuals or READ.ME files of the PC Cards or network drivers.



Note:
A *DOS Object* includes any DOS program, Windows program, DOS full-screen, DOS window, WIN-OS/2 full-screen, and WIN-OS/2 window objects.

Virtual Card Services for OS/2

When you use a DOS object in the OS/2 environment, OS/2 Virtual Card Services provides a Card Services interface so that you can use the DOS PC Card device driver for the DOS object.

To use Virtual Card Services in a DOS object, do the following:

- 1** Move the mouse pointer to the DOS object icon; then click on the right mouse button.
- 2** Select **Settings**.
- 3** Select **Session**.
- 4** Select **DOS (WIN-OS/2) Settings**.
- 5** Select **All DOS (DOS and WIN-OS/2) Settings**.
- 6** Set **PCMCIA_CARD_SERVICES** as **On**.
- 7** Set **PCMCIA_RELEASE_LEVEL** as **2.1**.
- 8** Set **MEM_EXCLUDE_REGIONS** as **C8000–CFFFF**.
- 9** Specify the PC Card device driver name to the **DOS_DEVICE**.

Even when a PC Card is enabled in a DOS object, the device driver or the application program may not work or their performance may not be what you expect.

Appendix C. Using PS2 Commands

Please note that PS2 commands are subject to change without notice. If you enter a command written in this section and receive an error, type `PS2 ?` and refer to the online help menu.

You can enter the following PS2 commands from the DOS and OS/2 command prompts to set the features for your computer. When entering a command, enter it in the following syntax:

PS2 [*Parameter1*] [*Parameter2*] [*Parameter3*]

Syntax Rules

Refer to these notes when you enter a command.

Syntax	Rule
	Select one of the options on either side of the vertical bar ().
Highlighted	Enter the exact highlighted letters in either uppercase or lowercase.
UPPERCASE	Enter any value for the following: XX: 0–20 HH: 0–23 MM: 0–59 SS: 0–59 The MM (minutes) and SS (seconds) are optional. The default values are 0.
lowercase	Command elements in lowercase are optional. For example, entering PS2 SE OF and PS2 Serial OFf gives the same results.

Using PS2 Commands

The following is a list of commonly used PS2 commands. It is organized as follows:

Description of the command

Parameter1	Parameter2	Parameter3
------------	------------	------------

Power Management Commands

Set whether to enter suspend mode when the LCD is closed:

Cover	Enable Disable	—
-------	------------------	---

Set POver, LCd, DISK, SPeed, and STandby to their original values:

DEFAULT	—	—
---------	---	---

Set the hard disk drive power-saving timer for the specified number of minutes (xx):

DISK	xx	—
------	----	---

Set the features for the infrared port (IR):

IR	Enable Disable ADDRESS	— 1 2 3 4
----	-----------------------------	--------------------

Create the hibernation file:

HFILE	C – Z DELete	—
-------	----------------	---

Enter hibernation mode when the power switch is pressed:

H SWITCH	Enable Disable	
----------	------------------	--

Set the timer to enter hibernation mode after the specified number of minutes (xx):

HTimer	xx	[AC DC]
--------	----	-----------

Set the power management mode to enter when a low-battery condition occurs:

AC: Specifies battery mode when the AC Adapter is connected.
DC: Specifies ac mode when using battery power:

LBattery	Suspend Hibernation	—
----------	-----------------------	---

Note:

This command is effective on the current power mode set by the PM command.

Note:

This command is effective on the current power mode set by the PM commands.

Note:

Use this command before using other hibernation commands.

Note:

Create the hibernation file using the HFILE command before using this command.

Note:

Create the hibernation file using the HFILE command before using the LB H command.

Using PS2 Commands

Note:

This command is effective on the current power mode set by the PM command.

Set the LCD off when there is no computer operation after the specified number of minutes (xx):

LCd	xx	—
------------	----	---

Note:

yyyy can be set from 1995 to 2093.

Set the resume timer:

ON at	[yyyy/MM/DD] HH:MM:SS Clear	—
--------------	----------------------------------	---

Set the power mode:

PMode	High Auto Custom	[AC DC]
--------------	----------------------	-----------

Note:

When the AC or DC option is not specified, this command is effective on the current power mode set by the PM command.

Set the timer to enter suspend mode after the specified number of minutes (xx):

AC: Specifies battery mode when the AC Adapter is connected.
DC: Specifies ac mode when using battery power.

POwer	xx	[AC DC]
--------------	----	-----------

RediSafe suspend mode:



Page 75.

Resume normal operation when detecting an incoming call:

RI	Enable Disable	—
-----------	------------------	---

Enter the RediSafe suspend mode:

SAfe	Enable Disable	—
-------------	------------------	---

Set power on or off for the serial device attached to the serial port:

SErial	ON OFF	—
---------------	----------	---

Note:

When the AC or DC option is not specified, this command is effective on the current power mode set by the PM commands.

Set the processor speed:

AC: Specifies battery mode when the AC Adapter is connected.
DC: Specifies ac mode when using battery power.

Parameter1	Parameter2	Parameter3	Parameter4
SPEED	Fixed Auto	MAX Medium Slow MIN	[AC DC]

Set the timer to enter hibernation mode from suspend mode after the specified number of minutes:

Parameter1	Parameter2	Parameter3
S2H	30 60 90 Disable	—

Using PS2 Commands

Set the timer to enter standby mode after the specified number of minutes (xx):

AC: Specifies battery mode when the AC Adapter is connected.

DC: Specifies ac mode when using battery power.

ST andby	xx	[AC DC]
-----------------	----	-----------

Note:

Create the hibernation file using the HFILE command before using the TH command.

Set the power management mode to enter by the automatic power-saving timer:

T imer	Suspend Hibernation	—
---------------	-----------------------	---

Display Commands

Set the screen expansion:

HVEX Pansion	ON OFF	—
---------------------	----------	---

Set where to display information:

S creen	LCD CRT BOTH	—
----------------	------------------	---

Set the frequency for the external monitor:

V SYNC	640×480 800×600 1024×768	60 72 75 85 56 60 75 85 Disable 43I 60 75 Disable
---------------	--------------------------------	---

Alarm (Sound) Commands

Set the computer to beep in certain conditions:

B EEP	ON OFF	Alarm System Warn
--------------	----------	--------------------------

System Setup Commands

Display the DMA channel assignments:

? DMA	—	—
--------------	---	---

Set the **Fn** key lock function:

FN Sticky	Enable Disable	—
------------------	------------------	---

Using PS2 Commands

Set the **HVEXP**ansion command to on or off with the **Fn+F8** key combination:

F8	Enable Disable	—
-----------	------------------	---

Display the interrupt level assignments:

? IRQ	—	—
-------	---	---



Set the timer for the CD-ROM drive to sleep after the specified number of minutes (*MM*):

CD timer	<i>MM</i> Default	—
-----------------	---------------------	---

Set the keyboard typematic speed:

K Rate	Normal Fast	—
---------------	---------------	---

Set the features for the parallel port:

PAR allel	Enable Disable ADDRESS MODE DMA	— LPT1 LPT2 LPT3 Uni Bi EPP ECP 0 1 3 Disable
------------------	--	--

Set the features for the serial port:

SERA	Enable Disable ADDRESS	— 1 2 3 4
-------------	-----------------------------	--------------------

Disable the screen off, standby, and suspend timers for presentations:

PRESEN tation	Enable Disable	—
----------------------	------------------	---

Set the features for the ESS AudioDrive (Sound Blaster) emulation:

Audio	Enable Disable ADDRESS IRQ DMA	— 220 240 5 7 10 11 0 1
--------------	---	--

Set the startup screen when the computer power is turned on:

START up	Enable Disable	—
-----------------	------------------	---

Set the TrackPoint III:

TPO int	Enable Disable	—
----------------	------------------	---

Using PS2 Commands

Other Commands

Display the help menu:

? Help	—	—
----------	---	---

Set the A: drive to the internal or external diskette drive:

FDD	Internal External	—
-----	---------------------	---

Enter hibernation mode:

HIBernation	—	—
-------------	---	---

Enter suspend mode:

OFF SUSpend	—	—
---------------	---	---

Turn off the computer:

TURN	OFF	—
------	-----	---

Note:
Create the hibernation file using the HFILE command before using this command.

Appendix D. Features and Specifications

This appendix describes the features and specifications for the IBM ThinkPad 365X/365XD superslim notebook computer.

Microprocessor

Intel Pentium processor

Memory

Built-in: A minimum of 8 MB RAM

Optional:

- 8 MB, 16 MB DIMM (70ns, 144-pin EDO)

Storage devices

- 2.5-inch hard disk drive (upgradable)
- 3.5-inch diskette drive
- 3.5-inch external diskette drive (for CD-ROM models)
- 5.25-inch 4X CD-ROM (available on some models)

Display

The SVGA color LCD display uses either TFT or DSTN technology (depending on the model) and supports:

DSTN color LCD

- Up to 256 colors
- Up to 800-by-600 resolution on the LCD and external monitor
- Brightness control and contrast control
- 1 MB built-in VRAM

TFT color LCD

- Up to 65,536 colors
- Up to 800-by-600 resolution on the LCD
- Up to 1024-by-768 resolution on the external monitor
- Brightness control
- 1 MB built-in VRAM

Keyboard

84-key, 85-key, or 89-key
TrackPoint III
Fn key functions
Embedded numeric keypad

Audio

Compatible with Sound Blaster Pro

Features and Specifications

External interface (standard for all models)

- DC-In jack for ac power supply
- Infrared port
- Serial connector (EIA-RS232D)
- Parallel connector (Centronics)
- External input-device connector
- External monitor connector
- Two PCMCIA slots (accept two Type I or Type II PC Cards, or one Type III PC Card)
- Port Replicator port

External interface (available on some models)

- Audio line-in jack
- Audio line-out/headphone jack
- Microphone jack
- External diskette drive port

Specifications

Note:

Actual specifications may vary based on features, vendor components, or manufacturer processes.

Size

Width: 297 mm (11.72 in.)

Depth: 210 mm (8.3 in.)

Height: 49.5 mm (1.95 in.)

Weight

Total system weight varies, depending on the LCD and hard disk drive installed.

For models with a built-in CD-ROM:

- 2.76 kg to 2.85 kg (6.1 lb to 6.3 lb)

For models with an internal diskette drive:

- 2.63 kg to 2.69 kg (5.8 lb to 5.9 lb)

Environment

Temperature

- Operating: 10°C to 35°C (50°F to 95°F)¹
- Non-operating: -20°C to 60°C (-4°F to 140°F)

Relative Humidity:

- Operating 8% to 80% (noncondensing)

Altitude: -61 m (-200 ft) to 3048 m (10,000 ft)²

¹ With diskette in drive

² In unpressurized conditions

Diskette Standards

Heat output

Approximately 119.4 British Thermal Units (BTUs) per hour (35.0 watts)

Electrical (AC Adapter)

Sine-wave input, at 50 to 60 Hz, is required

100–240 V ac

Battery pack (NiMH)

Output voltage: 9.6 V dc

Capacity: 2800 mAh

Diskette Standards

To get the best performance from your diskette drives, use high-quality diskettes (such as IBM diskettes) that meet or exceed the following standards:

1 MB, 3.5-inch, unformatted diskette:

ANSI (American National Standard Institute) X3. 137

ISO (International Standards Organization) 8860

ECMA (European Computer Manufacturers' Association) 100

2 MB, 3.5-inch, unformatted diskette:

ANSI X3. 171

ISO 9529

ECMA 125

IBM Power Cords

IBM power cords for a specific country are usually available only in that country. For 3-pin power cords:

Note

The grounded adapter is required for full MPRII compliance.

IBM Power Cord Part Number	Used in These Countries
25H2205	Argentina, Australia, New Guinea, New Zealand, Papua, Paraguay, Uruguay
25H2207	Bahamas, Barbados, Bermuda, Bolivia, Canada, Cayman Islands, Colombia, Costa Rica, Dominican Republic, Ecuador, El Salvador, Guatemala, Guyana, Haiti, Honduras, Jamaica, Korea (South), Mexico, Netherlands Antilles, Nicaragua, Panama, Peru, Philippines, Saudi Arabia, Suriname, Taiwan, Trinidad (West Indies), United States of America, Venezuela
25H2219	Thailand
25H2209	Austria, Belgium, Bulgaria, Czech Republic, Egypt, Finland, France, Germany, Greece, Hungary, Iceland, Indonesia, Netherlands, Norway, Poland, Portugal, Romania, Slovakia, Spain, Sweden, Turkey, former Yugoslavia
25H2211	Denmark
25H2213	Bangladesh, Pakistan, South Africa, Sri Lanka
25H2215	Abu Dhabi, Albania, Antigua, Bahrain, Brunei, Dubai, Fiji, Hong Kong, India, Ireland, Kenya, Kuwait, Macao, Malaysia, Nigeria, Oman, People's Republic of China, Qatar, Singapore, United Kingdom
25H2221	Switzerland
25H2223	Chile, Italy
25H2225	Israel
85G6665	Japan (2-pin)

IBM Power Cords

Attention:

If a 3-pin power cord came with your computer, you must follow the following safety notice.



DANGER

Electrical current from power, telephone, and communication cable is hazardous. To avoid shock hazard, connect and disconnect cables as shown below when installing, moving, or opening the covers of this product or attached devices. The 3-pin power cord must be used with a properly grounded outlet.

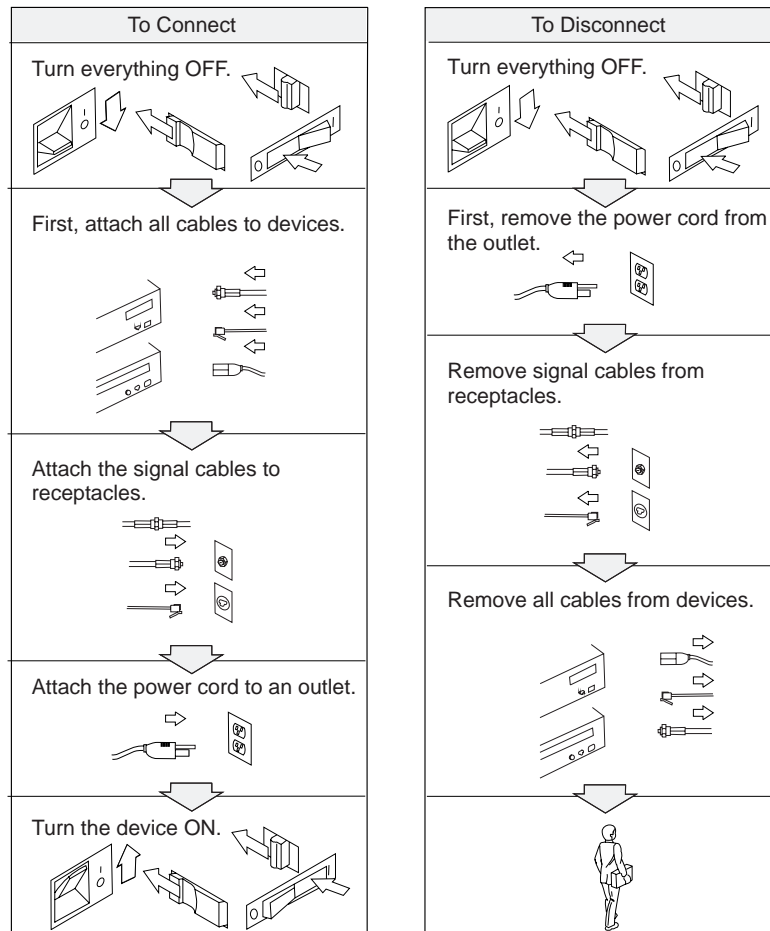

Note: In the U.K., by law:

The telephone line cable must be connected after the power cord.
The power cord must be disconnected after the telephone line cable.

Appendix E. Product Warranties and Notices

International Business Machines Corporation

Armonk, New York 10504

Statement of Limited Warranty

The warranties provided by IBM in this Statement of Limited Warranty apply only to Machines you originally purchase for your use, and not for resale, from IBM or an IBM authorized reseller. The term "Machine" means an IBM machine, its features, conversions, upgrades, elements, or accessories, or any combination of them. Machines are subject to these terms only if purchased in the United States or Puerto Rico, or Canada, and located in the country of purchase. If you have any questions, contact IBM or your reseller.

Machine: IBM ThinkPad 365X or 365XD

Warranty Period*: One Year

**Elements and accessories are warranted for three months. Contact your place of purchase for warranty service information.*

Production Status

Each Machine is manufactured from new parts, or new and serviceable used parts (which perform like new parts). In some cases, the Machine may not be new and may have been previously installed. Regardless of the Machine's production status, IBM's warranty terms apply.

The IBM Warranty

IBM warrants that each Machine 1) is free from defects in materials and workmanship and 2) conforms to IBM's Official Published Specifications. BM calculates the expiration of the warranty period from the Machine's Date of Installation. The date on your receipt is the Date of Installation, unless IBM or your reseller informs you otherwise.

During the warranty period, IBM or your reseller will provide warranty service under the type of service designated for the Machine and will manage and install engineering changes that apply to the Machine. IBM or your reseller will specify the type of service.

For a feature, conversion, or upgrade, IBM or your reseller may require that the Machine on which it is installed be 1) the designated, serial-numbered Machine and 2) at an engineering-change level compatible with the feature, conversion, or upgrade. Some of these transactions (called "Net-Priced" transactions) may include additional parts and associated replacement parts that are provided on an exchange basis. All removed parts become the property of IBM and must be returned to IBM.

Replacement parts assume the remaining warranty of the parts they replace.

If a Machine does not function as warranted during the warranty period, IBM or your reseller will repair or replace it (with a Machine that is at least functionally equivalent) without charge. If IBM or your reseller is unable to do so, you may return it to your place of purchase and your money will be refunded.

If you transfer a Machine to another user, warranty service is available to that user for the remainder of the warranty period. You should give your proof of purchase and this Statement to that user.

Product Warranties

Warranty Service

To obtain warranty service for the Machine, you should contact your reseller or call IBM. In the United States, call IBM at **1-800-772-2227**. In Canada, call IBM at **1-800-565-3344**. You may be required to present proof of purchase.

Depending on the Machine, the service may be 1) a "Repair" service at your location (called "On-site") or at one of IBM's or a reseller's service locations (called "Carry-in") or 2) an "Exchange" service, either On-site or Carry-in.

When a type of service involves the exchange of a Machine or part, the item IBM or your reseller replaces becomes its property and the replacement becomes yours. The replacement may not be new, but will be in good working order and at least functionally equivalent to the item replaced.

It is your responsibility to:

1. obtain authorization from the owner (for example, your lessor) to have IBM or your reseller service a Machine that you do not own;
2. where applicable, before service is provided —
 - a) follow the problem determination, problem analysis, and service request procedures that IBM or your reseller provide,
 - b) secure all programs, data, and funds contained in a Machine,
 - c) inform IBM or your reseller of changes in a Machine's location, and
 - d) for a Machine with exchange service, remove all features, parts, options, alterations, and attachments not under warranty service. Also, the Machine must be free of any legal obligations or restrictions that prevent its exchange; and
3. be responsible for loss of, or damage to, a Machine in transit when you are responsible for the transportation charges.

Extent of Warranty

IBM does not warrant uninterrupted or error-free operation of a Machine.

Misuse, accident, modification, unsuitable physical or operating environment, improper maintenance by you, or failure caused by a product for which IBM is not responsible may void the warranties.

THESE WARRANTIES REPLACE ALL OTHER WARRANTIES, EXPRESS OR IMPLIED, INCLUDING, BUT NOT LIMITED TO, THE IMPLIED WARRANTIES OF MERCHANTABILITY AND FITNESS FOR A PARTICULAR PURPOSE. HOWEVER, SOME LAWS DO NOT ALLOW THE EXCLUSION OF IMPLIED WARRANTIES. IF THESE LAWS APPLY, THEN ALL EXPRESS AND IMPLIED WARRANTIES ARE LIMITED IN DURATION TO THE WARRANTY PERIOD. NO WARRANTIES APPLY AFTER THAT PERIOD.

In Canada, warranties include both warranties and conditions.

Some jurisdictions do not allow limitations on how long an implied warranty lasts, so the above limitation may not apply to you.

Product Warranties

Limitation of Liability

Circumstances may arise where, because of a default on IBM's part (including fundamental breach) or other liability (including negligence and misrepresentation), you are entitled to recover damages from IBM. In each such instance, regardless of the basis on which you are entitled to claim damages, IBM is liable only for:

1. bodily injury (including death), and damage to real property and tangible personal property; and
2. the amount of any other actual loss or damage, up to the greater of \$100,000 or the charge for the Machine that is the subject of the claim.

Under no circumstances is IBM liable for any of the following:

1. third-party claims against you for losses or damages (other than those under the first item listed above);
2. loss of, or damage to, your records or data; or
3. economic consequential damages (including lost profits or savings) or incidental damages, even if IBM is informed of their possibility.

Some jurisdictions do not allow the exclusion or limitation of incidental or consequential damages, so the above limitation or exclusion may not apply to you.

This warranty gives you specific legal rights and you may also have other rights which vary from jurisdiction to jurisdiction.

Notices

Notices

References in this publication to IBM products, programs, or services do not imply that IBM intends to make these available in all countries in which IBM operates. Any reference to an IBM product, program, or service is not intended to state or imply that only IBM's product, program, or service may be used. Any functionally equivalent product, program, or service that does not infringe any of IBM's intellectual property rights may be used instead of the IBM product, program, or service. Evaluation and verification of operation in conjunction with other products, except those expressly designated by IBM, are the user's responsibility.

IBM may have patents or pending patent applications covering subject matter in this document. The furnishing of this document does not give you any license to these patents. You can send license inquiries, in writing, to:

IBM Director of Licensing
IBM Corporation
500 Columbus Avenue
Thornwood, NY 10594
USA

Trademarks

The following terms are trademarks of the IBM Corporation in the United States or other countries or both:

AT	Operating System/2	RediSafe
HelpClub	OS/2	ThinkPad
HelpWare	PC Card Director	TrackPoint III
IBM	PS/2	WIN-OS2

Windows is a trademark of Microsoft Corporation.

Other company, product, and service names, which may be denoted by a double asterisk (**), may be trademarks or service marks of others.

Electronic Emission Notices

Federal Communications Commission (FCC) Statement

Note: This equipment has been tested and found to comply with the limits for a Class B digital device, pursuant to Part 15 of the FCC Rules. These limits are designed to provide reasonable protection against harmful interference in a residential installation. This equipment generates, uses, and can radiate radio frequency energy and, if not installed and used in accordance with the instructions, may cause harmful interference to radio communications. However, there is no guarantee that interference will not occur in a particular installation. If this equipment does cause harmful interference to radio or television reception, which can be determined by turning the equipment off and on, the user is encouraged to try to correct the interference by one or more of the following measures:

Reorient or relocate the receiving antenna.

Increase the separation between the equipment and receiver.

Connect the equipment into an outlet on a circuit different from that to which the receiver is connected.

Consult an IBM authorized dealer or service representative for help

Properly shielded and grounded cables and connectors must be used in order to meet FCC emission limits. Proper cables and connectors are available from IBM authorized dealers. IBM is not responsible for any radio or television interference caused by using other than recommended cables and connectors or by unauthorized changes or modifications to this equipment.

Unauthorized changes or modifications could void the user's authority to operate the equipment. This device complies with Part 15 of the FCC Rules. Operation is subject to the following two conditions: (1) this device may not cause harmful interference, and (2) this device must accept any interference received, including interference that may cause undesired operation.

Electronic Emission Notices

Canadian Department of Communications Compliance Statement

This equipment does not exceed Class B limits per radio noise emissions for digital apparatus, set out in the Radio Interference Regulation of the Canadian Department of Communications.

Avis de conformité aux normes du ministère des Communications du Canada

Cet équipement ne dépasse pas les limites de Classe B d'émission de bruits radioélectriques pour les appareils numériques, telles que prescrites par le Règlement sur le brouillage radioélectrique établi par le ministère des Communications du Canada.

European Community Directive Conformance Statement

This product is in conformity with the protection requirements of EC Council Directive 89/336/EEC on the approximation of the laws of the Member States relating to electromagnetic compatibility.

A declaration of Conformity with the requirements of the Directive has been signed by IBM United Kingdom Limited, PO Box 30, Spango Valley, Greenock, Scotland PA160AH.

This product satisfies the Class B limits of EN 55022.

Glossary

This glossary includes terms and definitions from the *IBM Dictionary of Computing* (New York: McGraw-Hill, 1994).

ac (AC). Alternating current.

ac power. Power that is supplied to the computer through an electrical outlet.

Advanced Power Management (APM). A facility consisting of one or more layers of software that support power management in computers with power manageable hardware. The APM software interface allows applications, operating systems, device drivers, and the APM BIOS to work together to reduce power consumption, without reducing system performance.

ANSI. American National Standards Institute.

application program. A program that performs specific tasks on your computer, such as word processing or creating spreadsheets.

APM. Advanced Power Management.

ASCII. American National Standard Code for Information Interchange.

ATA PC Card. A PC Card with an AT attachment hard disk drive interface such as a storage device PC Card.

AUTOEXEC.BAT. A file that contains a startup procedure of DOS. Each time you start your system, DOS performs the commands that are stored in this file.

backup copy. A copy, usually of a file or group of files, that is kept in case the original file or files are unintentionally changed or destroyed.

batch. A process method in which a program or programs records with little or no operator action.

BIOS (Basic Input/Output System). Microcode that contains such basic hardware operations as interactions with diskette drives, hard disk drives, and the keyboard.

bitmap graphics. (1) A form of graphics in which all points on the display are directly addressable. (2) In multimedia applications, a form of graphics in an area of computer memory or storage that can be displayed as an image.

boot. To prepare a computer system for operation by loading an operating system.

bus. A facility for transferring data between several devices located between two end points, only one device being able to transmit at a given moment.

cache memory. A special memory, smaller and faster than main memory, that is used to hold a copy of instructions and data in main memory that are likely to be needed next by the processor, and that have been obtained automatically from main memory.

CD. Compact disc.

CD-I. Compact disc-interactive.

CD-ROM. Compact disc read-only memory.

combination keys. Keys that have specific functions when you hold them down at the same time.

CONFIG.SYS. A file that contains a group of commands to load installable device drivers and reserve space in system memory for information processing. This file is referred to by DOS during system startup.

configuration. (1) The manner in which the hardware and software of an information processing system are organized and interconnected. (2) The physical and logical arrangement of devices and programs that make up a data processing system. (3) The devices and programs that make up a system, subsystem, or network.

CRT. Cathode ray tube display.

device driver. A file that contains the code needed to attach and use a device. The operating system loads device drivers for screens, keyboards, printers, diskette drives, hard disk drives, and

auxiliary devices. The user can replace these or add other devices by coding and loading a device driver.

DIMM. Dual inline memory module.

directory. A type of file containing the names and controlling information for other files or other directories.

DMA. Direct memory access. The transfer of data between memory and input/output units without processor intervention.

double-click. To press and release a mouse button twice within a time frame defined by the user, without moving the pointer off the choice.

DRAM. Dynamic random access memory.

DSTN. Dual-scan, super-twisted nematic.

EDO. Enhanced Data Output or Extended Data Out. A type of DRAM that offers faster access to data in memory.

EGA. Enhanced graphics adapter.

EIA. Electronics Industries Association.

EIA-232D. An EIA interface standard that defines the physical, electronic, and functional characteristics of an interface line that connects a communication device and associated workstation. It uses a 25-pin connector and an unbalanced line voltage.

EMS. Expanded memory specification.

fax. Facsimile machine or transmitted document.

FDD. Floppy disk drive.

fixed disk. In personal computing, *fixed disk* is synonymous with *hard disk*.

flash memory. A rewritable storage that is used to contain BIOS instructions and POST routines.

folder. A file used to store and organize documents.

fuel gauge. An indicator on the screen that constantly shows the current power status of the battery pack.

HDD. Hard disk drive.

HHR. Half-horizontal resolution.

hibernation mode. One of the power-saving methods that stores data and applications running in the computer's memory on the hard disk. During hibernation, the computer is automatically turned off to save power. When power is turned on again, the computer immediately restores the same data and applications as when hibernation started, without restarting the operating system.

high-performance mode. A method of increasing the access time of video memories for DSTN LCDs, to produce high-quality video on an external monitor (CRT).

high-resolution mode. Video resolutions that are greater than 640 x 480 pels.

icon. A graphic symbol, displayed on a screen, that a user can point to with a pointing device such as a mouse to select a particular function or software application.

IR. Infrared.

IRQ. Interrupt request.

ISA. Industry standard architecture.

ISO. International Organization for Standardization.

JEIDA. Japan Electronics Industry Development Association.

kilobyte (KB). 1024 (2¹⁰) bytes.

LAN. Local area network.

LCD. Liquid crystal display.

LPT1 or LPT2. The name you can assign a parallel port to specify its address. See also *parallel port*.

mAh. Milliampere hours.

megabyte (MB). 1024 kilobytes. About 1 million (1,048,576 or 220) bytes.

memory. Often referred to as random-access memory (RAM), measured in kilobytes (KB) or megabytes (MB) of information.

MHz. Megahertz.

microcode. One or more microinstructions used in a product as an alternative to hard-wired circuitry to implement functions of a processor or other system component.

MIDI. Musical Instrument Digital Interface.

modem. A device that connects your computer to a telephone line, allowing it to communicate with another computer at another location.

parallel port. A port used to attach such devices as dot-matrix printers and input/output units; it transmits data 1 byte at a time.

parity check. A redundancy check by which a recalculated parity bit is compared with the pre-given parity bit.

partial suspend mode. A kind of suspend mode where only a part of the system components use power.

password. A series of letters or numbers that you designate to restrict access to your computer.

PC Card. A card that is based on the PCMCIA standard.

PCMCIA. Personal Computer Memory Card International Association.

pel. Picture element.

picture element. In computer graphics, the smallest element of a display surface that can be independently assigned color and intensity.

pixel. Picture element.

pointing device. An instrument, such as a mouse, TrackPoint III, or joystick, that is used to move a pointer on the screen.

POST. Power-on self-test.

pop-up menu. On the display screen, a menu that emerges in an upward direction from a particular point or line on a display screen.

prompt. A visual or audible message sent by a program to request the user's response.

pull-down menu. On the display screen, a menu that emerges in a downward direction from a point or line at or near the top of the screen.

reboot. Restart all operations of the computer as if the power were just turned on.

resume. To begin computer operations again from suspend mode.

serial port. A port used to attach such devices as display devices, letter-quality printers, modems, plotters, and such pointing devices as light pens and mice; it transmits data 1 bit at a time.

suspend mode. A power-saving mode in which all computer operations are stopped in order to reduce power drain and restrict access to the files.

SVGA. Super video graphics adapter, a video mode that produces up to 1024-by-768 resolution.

STN. Super-twisted nematic.

TFT. See *thin-film transistor*.

thin-film transistor (TFT). A type of material that is used to create some LCD computer screens.

TSRs. Terminate-and-stay-resident programs. Memory-resident programs that are loaded into memory and stay there so you can conveniently access them whenever you need to.

vertical expansion. A video display technique in character-display mode to fit video images on the whole LCD screen by adjusting the number of character dots vertically.

VESA. Video Electronics Standards Association.

VGA. Video graphics adapter, a video mode that produces up to 640-by-480 resolution.

XMS. Extended memory specification.

1KR or 2KR. 1K or 2K refresh rate.

A

- AC Adapter
 - input rating 21
 - power source 21
 - using 21
- America Online service 220
- API device driver, OS/2 PCMCIA storage card 252
- APM (advanced power management) 70
 - Windows, installing 165
- assistance 216
- ATA PC Card 249
- audio
 - features 56
 - support software 184
- Auto Configurator 239

B

- battery
 - maintenance 64
 - memory 64
- battery pack 62, 63, 64
 - charging 62, 63, 64
 - fuel-gauge program, using 68
 - maximizing battery-powered operation 70
 - monitoring battery power
 - fuel-gauge program, using 68
 - preserving battery-pack life 70
 - problems 204
- boot manager, OS/2 143
- boot, selectable 41
- broken keylock 202
- bulletin boards 219

C

- card in-use 19
- card services 49
- CardBus card 49
- carrying the computer 30
- CD-ROM drive 16
 - device drivers
 - handling CDs 59
 - problems 205
 - using 58, 59
- charging, battery indicator 19
- charging, battery pack 62, 63, 64
- cleaning the computer 29
- cleaning the TrackPoint cap 25

- CompuServe 220
- configuration menu, Easy-Setup 38
- Connectivity Services network 224
- consulting services 223
- corrective service diskette (CSD) 224
- custom services 223

D

- damage to computer, preventing 29
- date and time
 - Easy-Setup, setting 38
 - prompt 32
- dealer locations 217
- device driver
 - device drivers
 - for DOS, installing 158
 - for OS/2, installing 147
 - display driver
 - for OS/2, installing 155
 - for Windows 3.11, installing 173
 - for Windows 95, installing 177
 - infrared device driver
 - for OS/2, installing 153
 - for Windows 3.11, installing 172
 - for Windows 95, installing 186
 - PC Card Director
 - for DOS, installing 162
 - for OS/2, installing 151
 - for Windows 3.11, installing 170
 - for Windows 95, installing 180
 - PCI-IDE bus master driver
 - for OS/2, installing 150
 - for Windows 95, installing 179
 - ThinkPad features
 - for DOS, installing 161
 - for OS/2, installing 149
 - for Windows 3.11, installing 169
 - for Windows 95, installing 178
- diagnostic diskette 224
- DIMM adapter 119—124
- DIMM installation 119
- diskette drive 19
 - in-use, indicator 19
 - installing an external 57
 - problems 206
- Diskette Factory 3
- diskette standards 266
- display
 - output type 43
 - problems 43, 199
 - switching, using Fn key 27

- display (*continued*)
 - using 43
- display driver
 - for OS/2, installing 155
 - for Windows 3.11, installing 165, 173
 - for Windows 95, installing 177
- DMA channel, system resource 236
- DOS Version 7.0 157
- drive-startup sequence 41
- Drivers Selector, PC Card Director 52
- dual boot, OS/2 142

E

- Easy-Setup
 - configuration menu 38
 - date and time menu 38
 - password menu 39
 - restart menu 40
 - start-up menu 39
 - test menu 40
 - time and date menu 38
 - using 37
- EDO memory 263, 276
- electronic support 219
- ergonomics information x
- error codes 196
- ESS AudioDrive software
 - for Windows 95, installing 184
 - installing for OS/2 Warp 152
 - installing for Windows 3.11 171
- Ethernet RPL speed 42
- external diskette drive 5
- external keyboard
 - attaching 127
- external monitor
 - attaching 45
 - display driver
 - for OS/2, installing 155
 - for Windows 3.11, installing 173
 - for Windows 95, installing 177
 - setting 46
 - problems 43, 207
 - SVGA modes, using 48
 - using 43
- external numeric keypad
 - attaching 125
 - problems 209
- external printer 128
 - attaching 128
- ezplay command, for DOS 53

F

- FAQ 191—193
- fee services 221
- Flash card memory technology driver 252
- Fn key
 - function 26
 - lock 26
- fuel-gauge program
 - Fn key function, using 26
 - monitoring battery status 68
 - using 68

H

- handling precautions 29
- hard disk drive
 - securing, with password 89
 - upgrading 106
- hard disk password
 - changing 92
 - prompt 32
 - removing 93
 - using 89
 - wrong password 91
- hardware conflicts 236
- help 216
- HelpWare 217
- hibernation
 - file, creating 79
 - using 79
- hibernation mode
 - defined 276
 - Fn key function 27
 - points to consider 81
 - problems 208
 - PS2 command 262

I

- I/O address, system resource 236
- I99xxxxx
 - See error codes
- identification numbers, recording 215
- information notices viii
 - Caution notices viii
- infrared device driver
 - for OS/2, installing 153
 - for Windows 3.11, installing 172
 - for Windows 95, installing 186
- infrared port

- infrared port (*continued*)
 - problems 208
 - using 54
- initialization, Easy-Setup 38
- installing
 - external keypad 127
 - external numeric keypad 125
 - mouse 125
 - PC Card (PCMCIA card) 115
 - PCMCIA Card (PC Card) 116, 117
 - software 138
- IR
 - See infrared port
- IRQ, system resource 236

K

- keyboard
 - external, attaching 127
 - problems 209
- keyboard/mouse connector 127

L

- LAN startup services 223
- LCD
 - problems 44, 199
 - using 43
- locations 14
 - battery pack 16
 - bottom view 17
 - brightness control 15
 - CD-ROM drive 15, 16
 - CD-ROM eject 16
 - click buttons 15
 - contrast control 15
 - diskette drive 15
 - external diskette drive 18
 - external input-device connector 18
 - Fn key 15
 - function keys 15
 - indicator panel 15
 - infrared port 18
 - insulator sheet 16
 - keyboard lock 16
 - LCD screen 15
 - LCD suspend switch 15
 - legs 17
 - line-in jack 18
 - line-out/headphone jack 18
 - locking device keyhole 15
 - microphone-in jack 18

- locations (*continued*)
 - microphone, built-in 15
 - nameplate 15
 - optional memory (DIMM) 16
 - parallel connector 18
 - PC Card eject buttons 15
 - PC Card slots 15
 - Port Replicator connector 18
 - power jack 18
 - power switch 18
 - rear door 18
 - rear view 18
 - release latches 15
 - serial connector 18
 - speaker volume control 15
 - speakers 15
 - TrackPoint III 15
- locking devices 102
- low-battery condition 68

M

- memory 119, 123, 124
 - address, system resource 236
 - area 233
 - Easy-Setup 38
 - increasing capacity 119, 123, 124
- messages on screen 201
- miscellaneous items envelope 5
- modem
 - PC Card 115, 116, 117
- monitor
 - See external monitor
- Mount Utility, PC Card Director 52
- mouse
 - attaching 125
 - space saver keyboard, using with 126
 - using with
 - TrackPoint III 125

N

- network and server support services
 - fee 221
- network RPL (remote program load) 42, 234
- network, Connectivity Services
 - fee 224
- numeric keypad, operating 28
- numeric lock indicator 19

O

- online book viii
- Online Housecall 219
- online information services 219
- operating systems
 - installing 139
 - IBM PC DOS Version 7.0 156
 - OS/2 Warp Version 3 140
 - Windows 3.11 163
 - Windows 95 174
 - updates 224
- options 129—136
 - CardBus card 49
 - expansion unit 129—136
 - external keyboard 127
 - external monitor 45
 - external numeric keypad 125
 - mouse 125
 - PC Card, using
 - problems 210
- OS/2 Warp Version 3 141

P

- password 39
 - Easy-Setup 39
 - hard disk password
 - using 89
 - wrong, entering 91
 - personalization feature, using with 98
 - power-on password
 - using 84
 - wrong, entering 86
 - supervisor password
 - using 94
 - wrong, entering 95
- PC Card
 - advanced use 239
 - API device driver 252
 - ATA PC Card 249
 - Auto Configurator 239
 - CardBus card 49
 - Flash card memory technology driver 252
 - installing 115, 116, 117
 - problems 211, 232
 - registering 240
 - remote program load 232
 - resource conflicts, avoiding 255
 - resources, checking 253

- PC Card (*continued*)
 - suspend mode, using with 77
 - system boot up 232
 - using 49
 - virtual card services 256
- PC Card Director
 - installing, for DOS 162
 - installing, for OS/2 151
 - installing, for Windows 3.11 170
 - installing, for Windows 95 180
 - using 50
- PC Card Director Launcher 52
- PC DOS Version 7.0 157
- PCI-IDE bus master driver
 - installing, for OS/2 150
 - installing, for Windows 95 179
- PCMCIA card
 - See PC Card
- PCMCIA device driver
 - See PC Card Director
- PCMCIA.CRD, file 50
- personalization editor 98
- pointing device
 - attaching 125
 - problems 209
- Port Replicator, problems
- POST error prompt 201
- power command 70
- power cords 267
- power management
 - using 73
- power mode
 - switching, using Fn key 27
- power saving 73
- power-on indicator 20
- power-on password
 - changing 87
 - prompt 32
 - removing 88
 - using 84
 - wrong power-on password, entering 86
- power, providing 21, 22
- printer 128
 - problems 212
- problems
 - battery pack 204
 - CD-ROM drive 205
 - diskette drive 206
 - display 43
 - error codes 196
 - external monitor 207
 - external numeric keypad 209

- problems (*continued*)
 - FAQ 191—193
 - general 202
 - hibernation 208
 - infrared communication 208
 - IRQ 231
 - keyboard 209
 - LCD 44, 199
 - messages on screen 201
 - options 210
 - PC Card 211, 255
 - pointing device 209
 - Port Replicator 206
 - printer 212
 - resource conflict 231
 - serial port 210
 - software 213
 - testing the computer 194
 - TrackPoint III 209
 - troubleshooting charts 196—213
- Prodigy online service 220
- PS2 commands 257
 - A drive, setting 262
 - address of DSP 260
 - automatic power-saving timer 259
 - hibernation 260
 - suspend 260
 - beep on/off 260
 - default 258
 - display device 260
 - DMA information 260
 - expansion, horizontal/vertical 260
 - frequency, monitor 260
 - hard disk drive, power saving 258
 - help menu 262
 - HFILE 258
 - hibernate from suspend 259
 - hibernation, entering 262
 - HTIMER 258
 - HVEXP by Fn+F8 261
 - interrupt level information 261
 - IR 258
 - keyboard typematic speed 261
 - LCD power-off 259
 - low battery
 - hibernation, entering 258
 - suspend, entering 258
 - parallel port, enabling 261
 - power mode 259
 - power switch, hibernate 258
 - power to serial port 261
 - presentation 261
 - processor speed rate 259

- PS2 commands (*continued*)
 - RediSafe 259
 - resume date and time 259
 - resuming by the incoming call 259
 - serial port 259
 - sleep timer for the CD-ROM
 - drive 261
 - Sound Blaster 261
 - standby mode, timer 260
 - startup screen 261
 - suspend mode, entering 258, 262
 - TrackPoint III 261
 - turning off, the computer 262
- publications, ordering 224

R

- record of identification numbers 215
- RediSafe, suspend 75
- remote technical support 219
- removing the battery pack 65
- repair services 224
 - getting service 214, 224
 - identification numbers 215
- resource map utility 243
- restart menu, Easy-Setup 40
- resume function 73
- RPL (remote program load) 41, 234

S

- safety notice xii
- sales information 216, 217
- screen expansion 44
- screen messages
 - date and time prompt 32
 - F1 and diskette prompts 32
 - hard disk password prompt 32
 - power-on password prompt 32
 - power-on self-test (POST) error 32
- scroll lock, indicator 20
- security 102
 - locks 102
 - password
 - hard disk password 89
 - power-on password 84
 - supervisor password 94
 - personalization feature 98
- security locks 102
- serial number 215
- serial port, problems 210
- service 224—230

- service (*continued*)
 - how to get 214, 224
 - IBM Helpware 225, 230
- ServicePak 224
- services, fee 221
- shipped items 4
- socket services 49
- software
 - needed 138
 - problems 213
- solving problems yourself 216
- space saver keyboard 126
- standards, diskette 266
- standby mode
 - command 260
 - Fn key function, using 26
 - using 75
- start-up menu, Easy-Setup 39
- startup, changing 42
- storage card device driver 248
- supervisor password
 - changing 96
 - removing 97
 - using 94
 - wrong, entering 95
- support line services
 - ordering 222
- suspend mode
 - defined 277
 - Fn key function, using 26
 - points to consider 77
 - PS2 command 262
 - using 75
- SVGA monitor 43
- system resource list 236
- system status indicators 19
 - battery power status 19
 - diskette drive in-use 19
 - locations 19
 - numeric lock 19
 - power on 20
 - scroll lock 20
 - suspend mode 19
- SystemBoard, Easy-Setup 38

T

- technical support 217
 - fee 221
 - remote 219
- telephone assistance 217
- test menu, Easy-Setup 40
- testing the computer 194

- ThinkPad Features
 - fuel-gauge program 33
 - installing 149, 161
 - DOS Version 7.0 161
 - OS/2 Warp Version 3 149
 - Windows 3.11 169
 - Windows 95 178
 - personalization editor 33
 - PS2 commands
 - list 257
 - using 36
 - starting
 - for DOS 36
 - for OS/2 and Windows 34
 - tool bar 35
 - using 33
- ThinkPad system management device
 - driver 149
- time and date, setting 38
- token-ring RPL speed 42
- TrackPoint III 263
 - problems 209
 - using 23
- troubleshooting charts 196

U

- updates
 - operating system 224
- upgrading the hard disk drive 106
- Utility Diskettes 5

V

- video driver
 - See display driver
- virtual card services 256

W

- warranty 224
 - extensions and upgrades 223
 - product 269
 - service, international 218
- Windows 3.11, installing 165
- Windows 95, installing 175

IBM

Part Number: 76H7579

Printed in U.S.A.

