

HP OmniBook 800

User's Guide

(Windows 95)

HP OMNIBOOK 800 USER'S GUIDE	4
Using This Online Manual	4
Finding More Information	4
Notice	5
1. GETTING COMFORTABLE	6
Identifying Parts of the OmniBook	6
Adjusting the Display	8
To adjust the display	8
Using the Mouse.....	9
To use the mouse	9
To replace the mouse	10
Using Sound	11
To adjust the speaker volume	11
To connect a microphone, speakers, or headphones.....	11
To record and play sound.....	12
Using the OmniBook Keyboard	13
To use special features of the OmniBook keyboard.....	13
To start an application with a hot key	14
Learning About Windows.....	16
To learn about Windows	16
2. OPERATING THE OMNIBOOK	17
Checking the Status of the OmniBook	17
To view or hide the Status Panel	18
To move the Status Panel.....	18
To configure the Status Panel.....	18
Starting and Stopping the OmniBook.....	19
To start the OmniBook	19
To stop the OmniBook.....	19
To reset and restart the OmniBook.....	20
Using Storage Devices.....	22
To connect the floppy drive.....	22

To insert a PC card	23
To remove a PC card	25
3. MANAGING BATTERY POWER	26
Monitoring Battery Power	26
To get the battery status	26
Recharging and Replacing Batteries	27
To recharge the battery or run on ac power	27
To replace the battery.....	28
Controlling Battery Power	30
To respond to a low-battery warning	30
To save battery power	30
To change how power is managed.....	31
4. PROTECTING YOUR OMNIBOOK	32
Attaching a Security Cable.....	32
To attach a security cable.....	32
Setting Up Password Protection	33
To record your name or other PC identification.....	33
To set up password security.....	33
To delete a password.....	35
Protecting Your Data.....	36
To repair and clean up a disk	36
5. USING THE PERSONAL INFORMATION APPLICATIONS	37
Managing Your Time with Appointment Book	38
To start Appointment Book.....	38
To view your appointments	38
To change to a different day, month, or year	39
To add a new appointment.....	39
To add a new event.....	39
To delete an appointment or event	40
To run a program automatically.....	40
Listing People in Phone Book.....	41
To start Phone Book	41
To add a person to the list.....	41
To search for a person.....	42
Getting Answers from HP Financial Calculator.....	43
To start HP Calculator	43
To perform a math function on one number	43
To do simple arithmetic	44

6. CHANGING THE CONFIGURATION	46
Using HP User Tools.....	48
To run HP User Tools	48
Using the System Configuration Utility	50
To run the SCU	50
System Resources.....	53
7. TROUBLESHOOTING	55
Solving Problems	55
Printing Problems	55
Memory Problems.....	56
Mouse Problems	56
File, Drive, and PC Card Problems	57
Communications Problems	58
Sound Problems.....	59
Display Problems.....	59
Power Problems	60
Lockup Problems	62

HP OmniBook 800 User's Guide

This manual describes how to use the OmniBook with the Microsoft® Windows® 95 operating system. It focuses on the special Hewlett-Packard hardware and software, not the Windows operating system itself. For questions about the operating system, refer to the Microsoft Windows 95 manual shipped with the OmniBook.

Using This Online Manual

This online *User's Guide* looks similar to a printed manual—and it works like a printed manual in many ways, too. But you can do several handy things you can't do with a manual. For example, you can make the type larger or smaller. You can click pictures to enlarge them. You can add electronic bookmarks for marking key information. And you can print all or part of the manual on your printer.

- Press F1. You'll quickly see how to use this manual.

Hint

Hold FN and press ESC (FN+ESC) to hide the Status Panel while the manual is open—so it doesn't get in the way of the manual. Press FN+ESC again to show the Status Panel.

Finding More Information

This OmniBook *User's Guide* introduces the OmniBook and shows you how to operate your OmniBook. For more information about using your OmniBook, look in these additional places:

- The OmniBook *Installation and Setup Guide* shows how to set up the operating system, install and connect accessories, and maintain and upgrade the OmniBook. It also includes troubleshooting information.
- The *Introducing Microsoft Windows 95* manual, shipped with your OmniBook, contains information about using the standard features of Windows 95.
- The online Help for Windows applications provides information about those applications. Use the Help menu or Help button, or just press F1.
- The OmniBook Notes icon gives late-breaking information available after the online manual was completed. Double-click the OmniBook Notes icon in the OmniBook Library.
- Many bookstores have books about Windows and MS-DOS for people with different levels of experience.
- For updates and technical information, connect to our Web site on the internet at <http://www.hp.com/go/omnibook>. You can also find information about setting up operating systems and accessories such as network cards, get answers to common questions, and download electronic copies of documents.

Notice

This manual and any examples contained herein are provided “as is” and are subject to change without notice. Hewlett-Packard Company makes no warranty of any kind with regard to this manual, including, but not limited to, the implied warranties of merchantability and fitness for a particular purpose. Hewlett-Packard Co. shall not be liable for any errors or for incidental or consequential damages in connection with the furnishing, performance, or use of this manual or the examples herein.

Consumer transactions in Australia and the United Kingdom: The above disclaimers and limitations shall not apply to Consumer transactions in Australia and the United Kingdom and shall not affect the statutory rights of Consumers.

© Copyright Hewlett-Packard Company 1997. All rights reserved. Reproduction, adaptation, or translation of this manual is prohibited without prior written permission of Hewlett-Packard Company, except as allowed under the copyright laws.

The programs that control this product are copyrighted and all rights are reserved. Reproduction, adaptation, or translation of those programs without prior written permission of Hewlett-Packard Co. is also prohibited.

Portions of the programs that control this product may also be copyrighted by Microsoft Corporation, SystemSoft Corp., and NeoMagic, Inc. See the individual programs for additional copyright notices.

Microsoft, MS, MS-DOS, and Windows are registered trademarks of Microsoft Corporation (U.S. patent numbers 4955066 and 4974159). Pentium is a U.S. registered trademark of Intel Corporation.

For warranty information, see the *Support and Service* booklet.

Hewlett-Packard Company
Mobile Computing Division
1000 N.E. Circle Blvd.
Corvallis, OR 97330, U.S.A.

Edition 1 March 1997

1. Getting Comfortable

- [Identifying Parts of the OmniBook](#).
- [Adjusting the Display](#).
- [Using the Mouse](#).
- [Using Sound](#).
- [Using the OmniBook Keyboard](#).
- [Learning About Windows](#).

Congratulations! Your OmniBook sets a new standard in personal computing. Although it's compact and easy to carry, the OmniBook is equipped with a full-size keyboard, its own built-in mouse, and Microsoft Windows.

This chapter introduces the OmniBook and helps you get familiar with your new computer.

Identifying Parts of the OmniBook

The illustrations below point out key parts of the OmniBook. Most of these parts are discussed in this manual.

- | | | |
|-----------------------|---------------------|-------------------------|
| 1. Latch | 5. Card slots | 9. Mouse-eject button |
| 2. Security connector | 6. Card-eject lever | 10. Charging light |
| 3. Fn-key icon strip | 7. On/Off key | 11. Display adjustments |
| 4. Sound jacks | 8. Mouse | |

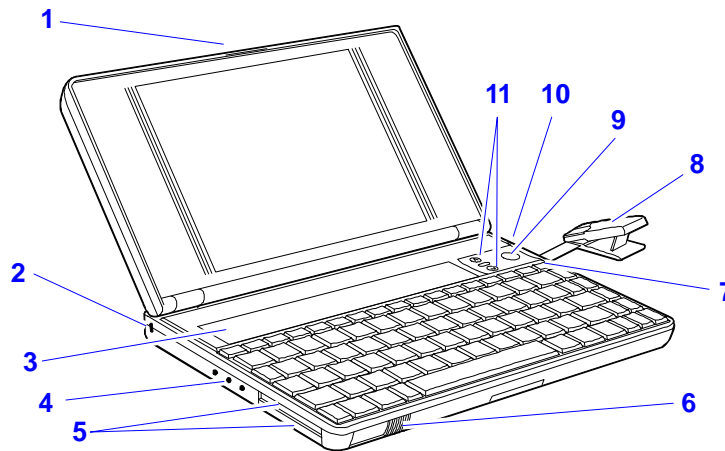

- | | | |
|-----------------------------|--------------------------|---------------------------|
| 12. Docking/SCSI port | 16. Floppy-drive port | 20. Memory-expansion slot |
| 13. Parallel port connector | 17. VGA output connector | 21. Identification pocket |

- 14. Infrared port (IrDA)
- 15. Serial port connector
- 16. Parallel port connector
- 17. Keyboard port
- 18. AC adapter socket
- 19. Reset button
- 20. Battery cover latch
- 21. Battery cover
- 22. Battery

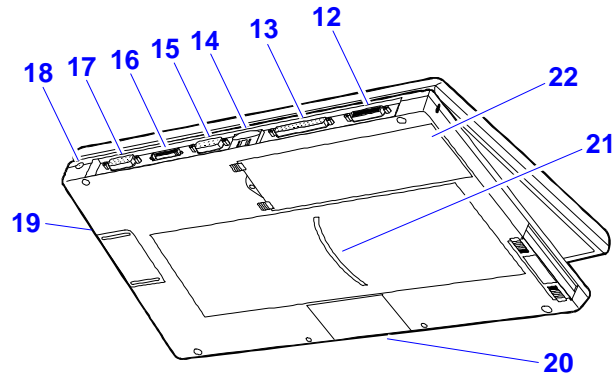

The floppy drive connects to the OmniBook externally—see ["To connect the floppy drive."](#)

Adjusting the Display

Your OmniBook display controls are located above the keyboard next to the mouse button.

To adjust the display

- Press the ^ and v buttons above the keyboard to adjust the brightness.

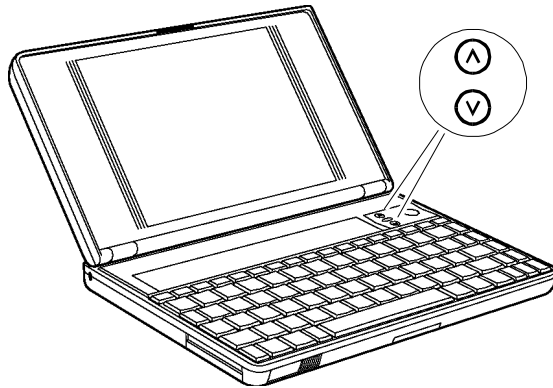

Hint

Brightness affects battery time. Keep in mind that a higher brightness setting gives a shorter battery operating time—because the internal light is using more power.

Use these buttons to make the display dimmer or brighter. Press and hold a button for fast changes, or press several times for greater control. You also can adjust the angle of the display for best visibility under the current light conditions.

When you turn on your OmniBook, the display can take 1 minute or more to reach its normal brightness. Cold temperatures delay full brightness.

Using the Mouse

The OmniBook mouse is PS/2-compatible.

The mouse is extremely sturdy. Its flexibility allows it to withstand bending and accidental bumps without breaking.

You use the OmniBook's two-button mouse just as you do the mouse on your desktop PC: Move the pointer to the icon or menu you want, and click with the left mouse button for most operations. Or *double-click*—click twice rather quickly with the left mouse button—for certain operations. However, the mouse doesn't need a surface to slide on—so you can use it anywhere.

In this section you'll learn how to

- [Use the mouse.](#)
- [Replace the mouse.](#)

To use the mouse

To pop out the mouse

1. Press the round mouse-eject button in the upper-right corner of the keyboard.
2. Firmly pull the mouse out past the first resistance to its full extended position—about 3 inches (8 centimeters).
3. Lift the end of the mouse nearest you—it pops up for a more comfortable shape.
4. Although the arm limits the *physical* extension of the mouse, it does not limit the travel of the pointer, as you will see. Just by pushing or pulling on the mouse, the pointer will continue to travel.

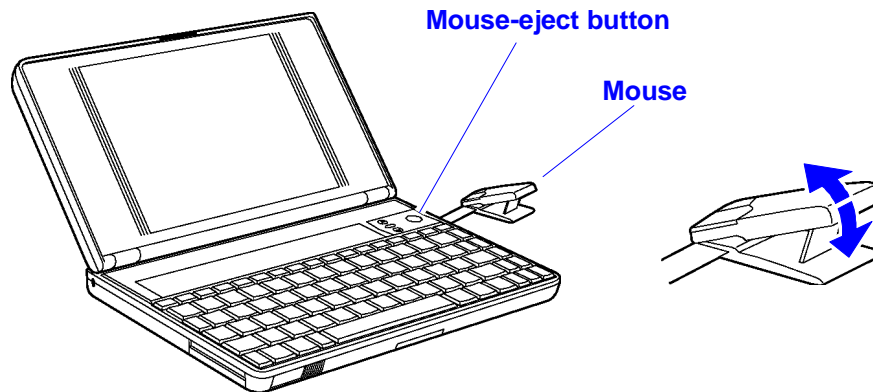

Once you've popped it out, you can use the mouse with the top popped up or collapsed. The popped up position is usually more comfortable, especially if you drape your hand over it as shown. But the collapsed position may be better if you're in a cramped environment, or you have to work with the OmniBook on your lap.

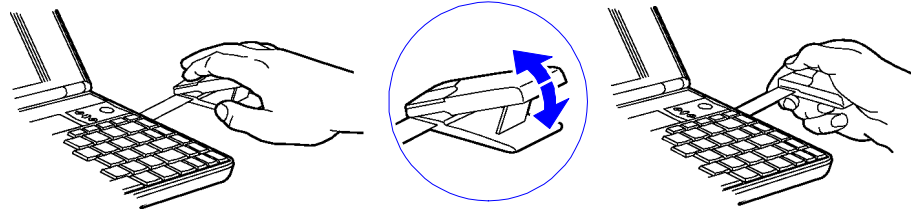

You can customize the operation of the mouse using Windows Control Panel Mouse.

To calibrate the mouse

Each time you turn on the OmniBook, you might notice that the mouse needs to re-calibrate itself—that is, it needs to redefine its margins.

- Push or pull the mouse against one vertical and one horizontal limit until the pointer on the screen travels to the edge of the screen.

To store the mouse

1. If the mouse is popped up, press inward on the support arm and press the raised end of the mouse downward to collapse it.
—or—
Tap down sharply on the raised end of the mouse.
2. Gently push the mouse into the case opening until it latches.

To replace the mouse

1. Tug sharply on the mouse to remove it and its arm from the computer.
2. Slip the arm of the new mouse into the slot inside the mousehole on the computer. Push the arm in and force it past the first resistance.

Using Sound

The OmniBook supports Sound Blaster compatible sound.

In this section you'll learn how to

- [Adjust the speaker volume.](#)
- [Connect a microphone, speakers, or headphones.](#)
- [Record and play sound.](#)

To adjust the speaker volume

- Hold down FN and press UP ARROW or DOWN ARROW as needed to gradually increase or decrease the volume. (The FN key is at the front-left corner of the OmniBook keyboard.) This setting is temporary—it applies only to the current sound file.

—or—

1. Click the speaker symbol in the taskbar.
2. Drag the volume control up or down to adjust the volume.

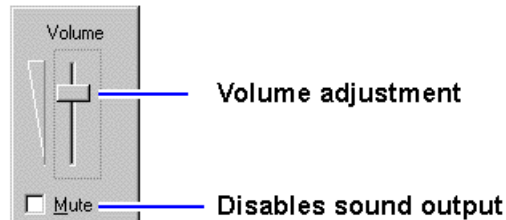

Double-click the speaker symbol in the taskbar to open the mixer controls.

You can press FN+LEFT ARROW or FN+RIGHT ARROW to change the volume of just the beeper channel (sometimes called “PC speaker”).

To temporarily silence the speaker output without changing the volume setting:

- Press FN + SPACEBAR. Press it again to cancel. This is a temporary setting.

—or—

- Click Mute in the Volume window.

To enable Zoomed Video sound

If you add a Zoomed Video PC card (it must be in the upper card slot, which is slot zero), its sound capability will not work until you activate Zoomed Video sound.

- Click Start, Programs, OmniBook, OmniBook Zoomed Video, then turn Zoomed Video sound on or off. (While Zoomed Video sound is turned on, normal sounds related to PC card activity are disabled.)

To connect a microphone, speakers, or headphones

Your OmniBook has a built-in microphone above the keyboard and two speakers. Although the OmniBook has stereo sound, both built-in speakers play a mix of the right and left channels.

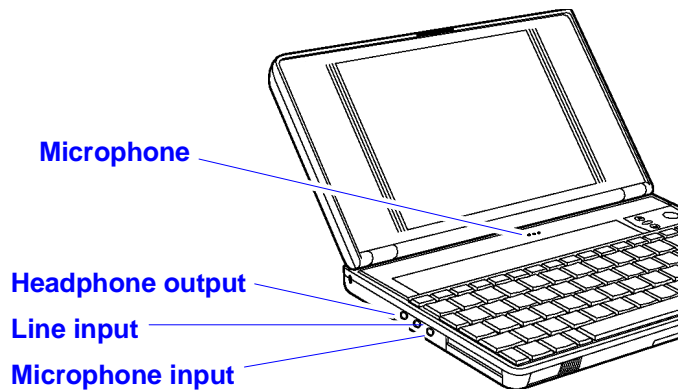

You can also plug in an external microphone, external speakers or headphones, and a stereo input source, such as a CD player.

- Plug the microphone into the microphone jack. The built-in microphone turns off.
- Plug the stereo speakers or headphones into the output jack. The built-in speakers turn off.
- Plug a stereo input source into the input jack.

To record and play sound

- Use the Windows Sound Recorder application. You can record sounds, and you can open an existing sound file and play it.
Click Start, Programs, Accessories, Multimedia, Sound Recorder.

Using the OmniBook Keyboard

In the section you'll learn how to

- [Use the special features of the keyboard.](#)
- [Start an application using a hot key.](#)

To use special features of the OmniBook keyboard

In addition to the standard typing keys, the OmniBook keyboard contains the following special keys and features:

FN combination keys

The orange FN key is located at the front-left corner of the keyboard. Use the FN key in combination with other keys to execute special functions and to start applications assigned to the function keys F1, F2, and so on. For example, FN+DOWN ARROW decreases the speaker volume. You press *and hold* the FN key, then you press the other key.

FN Combination	Action
FN+ESC	Displays or hides the Status Panel.
FN+HOME, END, PgUp, PgDn	Moves the Status Panel to another corner.
FN+UP ARROW, FN+DOWN ARROW	Increases and decreases the master volume temporarily.
FN+SPACE	Switches the master volume off (mute) or on.
FN+LEFT ARROW, FN+RIGHT ARROW	Adjusts the beeper mix/volume temporarily.
FN+TAB	Moves a VGA-sized image to the center or to the upper left of the display, or expands it to full size.
FN+PrtSc	Selects an external display, both displays simultaneously, or the OmniBook display.
FN+EQUAL (plus), FN+HYPHEN (minus)	Increases the bus speed to normal or decreases the bus speed to half-speed. (Some parallel devices require the slower bus speed.)
FN+On/Off	If turn-on password protection is active, suspends (turns off) the OmniBook so the password is required at turn-on.
FN+F1 ... F12	Starts the assigned application, which you can change.

Numeric keypad

Press the NUM LOCK (number lock) key to use the numeric keypad. With the keypad active, keys change to the designations shown on their front, slanted faces.

ALT GR key

If your keyboard has an ALT GR key to the right of the spacebar, hold that key to type the characters printed at the bottom-right corners of keys. For keys that have four characters, hold SHIFT and ALT GR to type the upper-right characters.

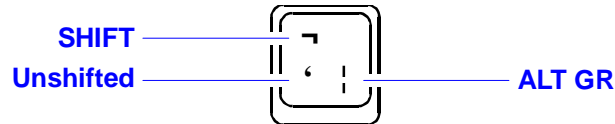

To start an application with a hot key

If an application has been assigned to keys F1 through F12, then it has a *hot-key assignment*. A hot key sequence is a shortcut to start a function or program.

- Press and hold FN, and simultaneously press the function key (F1 to F12) for the assigned application.





Of course, you can always start an application by selecting it in Windows. The usual Windows methods work for all applications, whether they have hot key assignments or not.

To use a FN key

FN is the “key” to hot-key assignments. You can easily set up a hot *function key* (F1 through F12) for any application present on your OmniBook—then press FN together with that key to start the application from Windows. The function keys, labeled F1 through F12, are on the top row of the keyboard.

You can use the FN+function-key combination to start an application or switch to a running application at any time, even if you’re working in another application.

Certain FN+function key combinations are predefined (but redefinable). They are labeled with symbols above the F1 through F5 keys. Their FN functions are shown by small icons above the keys. You can print and insert a new icon-label strip that shows other applications you assign to the FN function keys.

Fn+F1	Fn+F2	Fn+F3	Fn+F4	Fn+F5
				
Start	Explorer	HP User Tools	Status Panel	OmniBook User's Guide

To set up a shortcut key sequence (FN key)

You can set up shortcut access to programs (applications) and documents. (Refer to the *Introducing Windows 95* book or the Windows online Help.) After you create a shortcut (an icon on your desktop), you can replace it with a *shortcut key sequence* of FN+F1 through FN+F12. This provides a shortcut that does not clutter your desktop.

1. In Windows Explorer, highlight the application you want to create a shortcut access to.
2. Use the right mouse button to drag the item to the desktop. When you release the mouse button, click Create Shortcut Here. This creates an icon on your desktop labeled "Shortcut to ."
3. Start the FN F1-F12 Shortcut Key Assignment: click Start, Programs, OmniBook, FN F1-F12 Shortcuts.
4. Use the left mouse button to drag the Shortcut icon to an empty icon field in the FN F1-F12 Shortcut Key Assignment box.
5. If you installed a printer in Windows, you can print out a new icon strip for the OmniBook. Click Print Icons, then close this box. After the label prints, cut it to size as marked.
6. Use your fingernail or a paper clip to pull out the plastic tray from the pocket above the keyboard. Use a small piece of tape to attach the right end of the strip to the right end of the tray. Then reinsert the tray.

To edit or delete a shortcut key sequence

1. In Windows Explorer, highlight the file with the shortcut assignment you want to change. It will be in the directory Windows, Start Menu, Programs, OmniBook, FN Shortcuts.
2. Delete or edit the shortcut key assignment:
 - To delete this shortcut key assignment, point the arrow cursor at the icon next to the filename and press DEL.
 - To edit this shortcut key assignment, press the right mouse button to open the Properties sheet. Click the Shortcut tab. In the field labeled Shortcut Key, you can change the key sequence simply by pressing the desired keys.

To access a FN key combination from a keyboard without an FN key

If you are using a docking system with an external keyboard, you can set up CTRL+ALT as a substitute for FN.

- Enable the external FN key: In HP User Tools, click OmniBook External Devices on the Settings tab, then mark the Enable External FN Key option.
- Substitute the keystrokes CTRL+ALT for FN.

Learning About Windows

To learn about Windows

This OmniBook *User's Guide* does not discuss the Windows operating system. Rather, it introduces the OmniBook and shows you how to operate it. For information about Windows, see the following sources:

- Start the 10-minute tour of Windows 95. Click Start, Programs, OmniBook Library, Tour of Windows 95.
- See the Windows online Help. Click Start, then Help.
- See the *Introducing Microsoft Windows 95* manual shipped with your OmniBook.
- Many bookstores have books about Windows for people with different levels of experience.

2. Operating the OmniBook

- [Checking the Status of the OmniBook.](#)
- [Starting and Stopping the OmniBook.](#)
- [Using Storage Devices.](#)

Your OmniBook has been specifically designed for ease-of-use on the road. It features “instant-on” power that immediately restores your last screen. The Status Panel provides convenient status information. And the OmniBook supports a variety of storage devices.

Checking the Status of the OmniBook

The Status Panel contains indicators that show the current status of the OmniBook for the C drive, the three keyboard locks, and the battery power level. You can turn the Status Panel on and off by pressing FN+ESC.



- 1. Drive C** The disk symbol shows whether the hard drive (drive C) is active (that is, reading or writing).
- 2. Keyboard** The A, 1, and arrow labels appear if Caps Lock, Num Lock, and Scroll Lock are active. (Certain applications such as Word also show keyboard status in the application window.)
- 3. Power** The shading of the battery symbol shows the approximate charge level of the battery relative to a full charge.
A plug symbol is displayed while the ac adapter is connected and supplying power.
The electrical bolt symbol means that the battery is being quick-charged (less than 90% charged).

Indicators other than Power automatically appear only when relevant, such as while a keyboard lock is active or while a drive is active. For other options, see ["To configure the Status Panel."](#)

The Windows 95 taskbar also shows status information about ac power or battery use, sound, infrared, and PC card use. The indicators shown vary depending on the current state of the OmniBook—whether a PC card is present or whether ac power is connected, for example.



Some of the taskbar indicators provide information or control when you move the mouse pointer over the indicator or when you click the indicator (or double-click, or right-click). For example, double-click the ac or battery indicator to find out how much battery power remains.

In this section you'll learn how to

- [View or hide the Status Panel.](#)
- [Move the Status Panel.](#)
- [Configure the Status Panel.](#)

To view or hide the Status Panel

At any time, you can hide or display the Status Panel.

- Press FN+ESC—the panel becomes hidden or visible.

You can't display the Status Panel if you've disabled it. See "[To configure the Status Panel.](#)"

To move the Status Panel

- Press FN+HOME, FN+END, FN+PAGE UP, or FN+PAGE DOWN to move the Status Panel around the corners of the display. This allows you to view what the Status Panel might be obscuring.

To configure the Status Panel

You can enable or disable the Status Panel and specify its location and contents: power status, keyboard status, and drive C status.

- Open HP User Tools (click Start, HP User Tools). On the Settings tab, click OmniBook Status Panel Setup.

—or—

- Run the [System Configuration Utility](#) and use the System menu Status Panel Settings command.

Starting and Stopping the OmniBook

You can easily start and stop your OmniBook using the blue On/Off key. But at certain times, you may want to use other methods for starting and stopping your OmniBook, depending on power considerations, types of active connections, and startup time.

In this section you'll learn how to:

- [Start the OmniBook.](#)
- [Stop the OmniBook in different ways.](#)
- [Reset and restart the OmniBook.](#)

To start the OmniBook

- Press the blue On/Off key. Either your previous session resumes or the computer reboots, depending on how you stopped the computer. See the next topic.

To stop the OmniBook

You can stop or “turn off” the OmniBook several ways, including “Instant-On” so you can quickly continue your work where you left off. That’s unlike a desktop PC that starts from scratch every time you turn it on. Often, the way you stop your OmniBook depends on how you intend to use it the next time.

- | | |
|--|---|
| • To stop with “Instant-On” with ac power, press the blue On/Off key. | Display Off: Ready to continue immediately and maintains external connections. (Most convenient method for Windows 95 and Windows for Workgroups if ac power is available.) |
| • To stop with “Instant-On” on battery power, press the blue On/Off key. | Suspend: Ready to resume immediately. You intend to continue within a week or so. (Most convenient method for Windows 95 and Windows for Workgroups if ac power is not available.) |
| • To shut down without saving your session, shut down Windows, then hold CTRL and ALT and press the On/Off key. (For Windows 95, the OmniBook automatically turns off when you shut down Windows.) | Off: Starts a new session next time. Reboots at turn-on. (Standard method for Windows NT and OS/2.) |

Hint

Preserving connections. If you have active network connections, or if you have any SCSI devices connected, use the ac adapter and press the On/Off key to stop the OmniBook. These connections and devices are disconnected if you stop the OmniBook any other way.

However, Windows 95 can restore network connections and SCSI devices when you turn on the OmniBook. For a different operating system, you may have to reboot the OmniBook or restart the operating system to restore them.

If you want to know more about what happens when you stop the OmniBook, you can check the following table.

Power States after Stopping the OmniBook

Method of Stopping	Power State	Condition
On/Off key (with ac adapter connected)	Display Off	Powered/operating state. The computer looks off, but only the display, keyboard, and mouse are turned off. Network and SCSI devices are maintained. Everything continues at turn-on.
On/Off key (with no ac adapter)	Suspend	Low-power/stopped state. Everything is off or in a low-power state. Network and SCSI devices are off. Everything resumes operating at turn-on. For Windows 95, SCSI changes are detected at turn-on.
CTRL+ALT+On/Off key	Off	Low-power/stopped state. Everything is off or in a low-power state (battery charges if ac adapter is connected). Computer reboots at turn-on.

The Start button provides two commands that stop the OmniBook.

- Suspend changes the OmniBook to the Suspend state.
- Shut Down (Shut down the computer) changes the OmniBook to the Off state.

If you plug in the ac adapter while the OmniBook is stopped, battery-charging components are activated, but the OmniBook stays in the same power state. On the other hand, if you unplug the ac adapter while the OmniBook is in the Display Off state, it changes to the Suspend state.

In addition, Advanced Power Management (APM) provides several automatic power-saving features that affect the power state. You can adjust settings in the [System Configuration Utility](#) to control features such as this:

- If the OmniBook is running on battery power and there's no activity for a short period of time, it automatically stops by changing to the Suspend state.

To reset and restart the OmniBook

If Windows or the OmniBook gets stuck and stops responding (and you can't recover in Windows), you can reset the OmniBook and restart Windows.

1. If possible, shut down Windows.
2. Press CTRL+ALT+DEL to reboot the OmniBook.

–or–

Insert a ballpoint pen tip or straightened paperclip into the small hole below the charging light and press the reset button inside the hole. Resetting is more complete than rebooting because it resets even locked-up components.

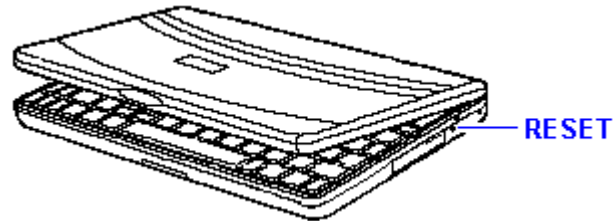

If these actions have no effect, remove the battery and ac adapter and press the reset button. Then install the battery or plug in the ac adapter and try pressing the reset button again.

Hint

Rebooting from a floppy disk. If you want to reboot from a boot disk in the floppy drive, put the disk in the floppy drive before you restart the OmniBook. For example, you can reboot from the *Support Utility* disk, then use the commands on this disk to check your hard disk.

Using Storage Devices

Your OmniBook can access information in the following types of data storage devices. Each device is assigned a drive letter by the operating system. For example, the floppy drive is drive A, and the internal hard disk is drive C. Drive letters for other devices depend on what devices are present.

- The floppy disk drive (if present).
- The internal hard disk drive.
- Data storage cards in one or both PC card slots (if present). The upper slot is the first slot.
- SCSI CD-ROM drives or hard drives (if present, as with a docking system).

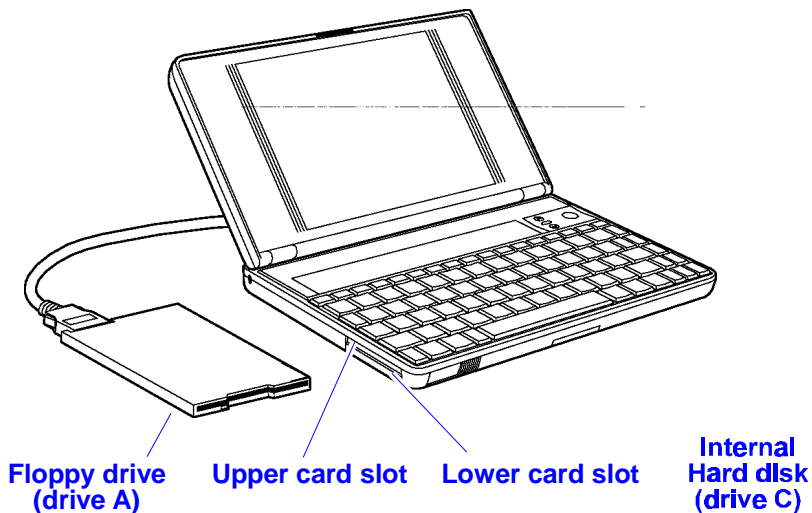

In this section you'll learn how to

- [Connect the floppy disk drive.](#)
- [Insert a PC card.](#)
- [Remove a PC card.](#)

Note

See the OmniBook *Installation and Setup Guide* for information about installing and setting up accessories, including data storage devices.

To connect the floppy drive

1. Find the floppy-drive cable included with the OmniBook.
2. Plug the larger plug (pinching its tabs) into the back of the floppy drive.
3. Plug the smaller plug into the floppy-drive port at the back of the OmniBook.

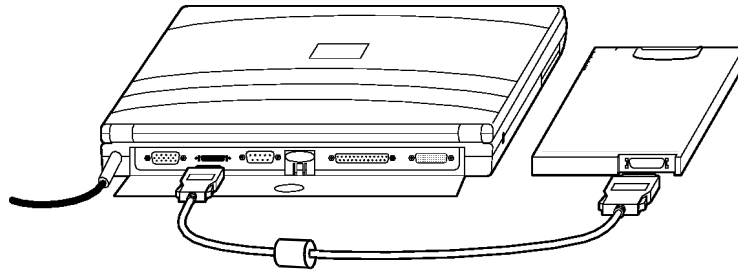

Caution

Do not insert or remove a floppy disk while the OmniBook is actively reading or writing data. Wait until the floppy drive is done. Otherwise, you could lose data or the OmniBook could stop responding.

To insert a PC card

The OmniBook PC card slots are available for storing data and expanding the communication capabilities of the OmniBook. The OmniBook supports standard Type I, II, and III PC cards (PCMCIA and CardBus). You can use two thin cards or one thick card. The upper card slot supports Zoomed Video, which allows a zoomed video card to show high-quality multimedia presentations.

For information about compatible cards, visit our Web site at <http://www.hp.com/go/omnibook>. Or contact Hewlett-Packard as described in the *Support and Service* booklet or in OmniBook Support in the online OmniBook Library.

Caution

Do not install Card Services or Socket Services software if it comes with your PC card. The OmniBook already includes Card Services and Socket Services, which automatically detect and set up PC cards you install in the upper and lower card slots. Different versions of this software will disrupt this support.

Never insert or remove a plug-in card while an OmniBook PC card drive is actively reading or writing data. Wait until the PC card drive is done. Otherwise, you could lose data or the OmniBook could stop responding.

The OmniBook automatically detects and sets up a card when you insert it in a card slot. See the card's instructions for additional information.

To insert a card in the upper slot

- Hold the card with its face up and its connector holes toward the card slot, then slide it into the slot until it won't go any further. The card should be about flush with the case.

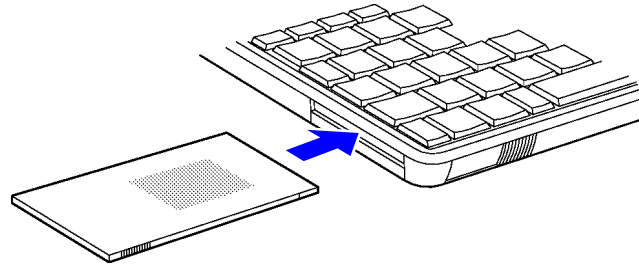

To insert a card in the lower slot

1. Turn over the OmniBook, release the two latches on the bottom of the slot tray, and pull out the tray.

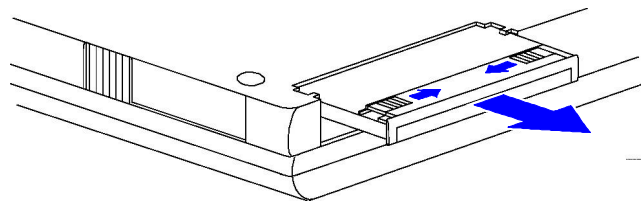

2. Lift or push the plastic spacer out of the tray. (Save the spacer in case you remove the card later—it keeps dust and dirt from getting inside the case.)
3. Install the new card into the tray with its face up and its connector holes toward the metal tabs at the end of the tray.

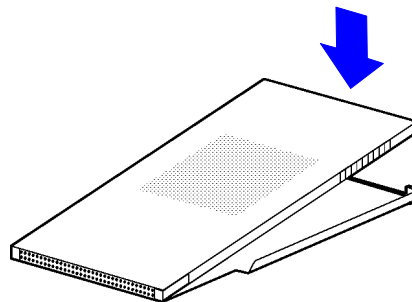

4. Slide the tray fully into the slot and secure its latches.

[↩ About RAM Cards](#)

Start popup

About RAM Cards

If you're using a RAM card with the OmniBook, keep these suggestions in mind:

- For a new RAM card, install its battery before you insert the card.
- Replace the RAM card battery yearly.

When you want to replace a RAM card battery, plug the card into the OmniBook and make sure the OmniBook stays turned on while you replace the battery. You can plug in the ac adapter to keep it from turning off. Otherwise, the data on the card will be lost.

- To use an SRAM card, you must first load drivers for it. Refer to the online Help for Windows 95.

End popup

To remove a PC card

Caution

Never remove an I/O card while an application is open that's set up to use that card. Exit the application first. If you remove the card, the application (or the OmniBook) might behave unpredictably or stop responding until you restart the OmniBook.

Never insert or remove a plug-in card while the PC card drive is actively reading or writing data. Wait until the PC card drive is done. Otherwise, you could lose data or the OmniBook could stop responding.

1. Click the PC card indicator in the taskbar, then click Stop.

This protects your data and avoids unexpected problems. You can restart the card by removing it, then inserting again.

2. For a card in the upper card slot, slide the card-eject lever toward the end of the case until the card pops out, then pull out the card.

—or—

For a card in the lower card slot, turn over the OmniBook, release the two latches on the bottom of the slot tray, and pull out the tray.

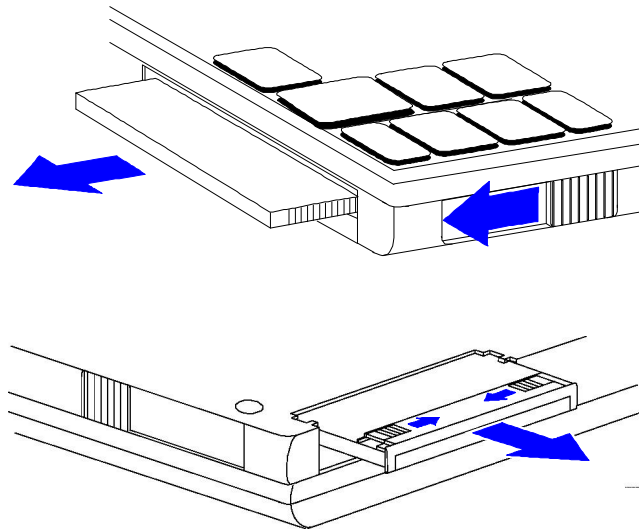

3. Managing Battery Power

- [Monitoring Battery Power.](#)
- [Recharging and Replacing Batteries.](#)
- [Controlling Battery Power.](#)

The primary source of power for the OmniBook is its rechargeable battery. The OmniBook provides several safeguards so that you won't be surprised by a dead-battery condition. The Status Panel shows the remaining battery charge and built-in warnings are displayed for low-battery conditions.

To preserve your current work session, the OmniBook automatically turns off when the battery charge gets too low. Your session continues when you plug in the ac adapter or insert a fresh battery.

Monitoring Battery Power

To get the battery status

- Check the Battery indicator in the [Status Panel](#). If it's not visible, press FN+ESC to view it. The shading indicates the approximate charge level. It's *approximate* because it's rounded to the nearest 1/8. (The AC and Quick-Charge indicators show whether the ac adapter is plugged in and whether the battery is quick-charging.)



–or–

- Move the mouse pointer onto the ac or battery indicator at the right end of the taskbar. The approximate battery charge is displayed in a pop-up window.



For additional power information, open the Control Panel Power window.

All battery indicators show approximately the same battery charge level. However, because they have different resolutions, they may not show identical levels.

Hint

Updating the battery indicator. If you ever suspect a battery indicator does not represent the actual condition of the battery, do the following to update the indicator:

- Plug in the ac adapter and wait until the charging light turns green, or
 - Unplug the ac adapter, press the blue On/Off key to turn off the computer, then press F4+On/Off to turn it on again.
-

Recharging and Replacing Batteries

You can use the ac adapter to recharge the battery—and to run on ac power to preserve the battery. The OmniBook conserves power by using Advanced Power Management (APM), software that controls power drain.

Data on any of the drives is not affected by a low battery. However, the data could be affected if the battery runs down completely while writing data to the drive.

In this section you'll learn how to

- [Recharge the battery or run on ac power.](#)
- [Replace the battery.](#)

To recharge the battery or run on ac power

- Plug the power cord into the adapter, then into a grounded ac outlet.
- Insert the adapter plug into the socket at the right-rear corner of the OmniBook.

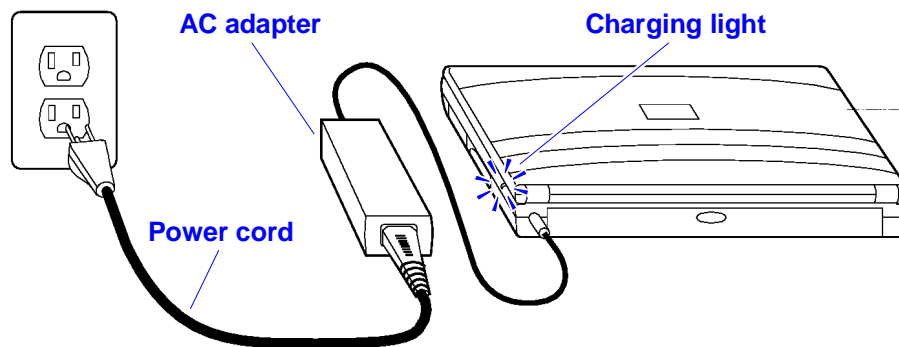

Caution

Use only an HP F1044B ac adapter (the type shipped with your OmniBook) or an HP-approved ac adapter. *Using any other adapter could damage the OmniBook and void your warranty.* Always plug it into a grounded outlet. Note that the adapter plug has negative polarity—the inner contact is negative, and the outer is positive.

Unplug the ac adapter from the OmniBook *before* you unplug the power cord. Otherwise, the OmniBook could stop responding, requiring a reset.

The ac adapter is normally warm to the touch whenever it's plugged into an ac outlet. The OmniBook is normally warm while it's charging. Don't charge it in a briefcase or other small space.

It's a good idea to use the ac adapter during operations that take more power—for example, those involving certain external connections, such as using a floppy drive or serial port.

The charging light turns on while the ac adapter is plugged in.

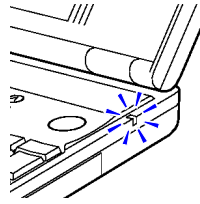

OmniBook Charging Light

Color	Meaning for Battery
Off	AC adapter not connected.
Orange	Charging.
Green	Charging 90% - 100%.
Red	Bad battery or missing battery.

Hint

Optimum charging. To get the longest battery operating time, wait until the Battery indicator in the Status Panel appears full. The battery normally reaches 100% about 1 hour after the charging light turns green.

You can continue working while the battery is charging. The charging rate is not affected by using the computer.

To replace the battery

You may never need to remove the rechargeable battery in ordinary use. Just connect the ac adapter to the OmniBook and recharge the battery while you work. However, you can replace a low battery with another that is more fully charged.

Caution

If you have the ac adapter plugged in when you remove the battery, do not disconnect it while the battery is out. If you do, your current session and any unsaved data will be lost.

Use only a Hewlett-Packard lithium-ion (Li-Ion) battery.

1. Important

Save your work. Then press the On/Off key to stop the OmniBook.

2. If available, plug in the ac adapter.
3. Release the two latches on the battery on the bottom of the case, then remove the battery.

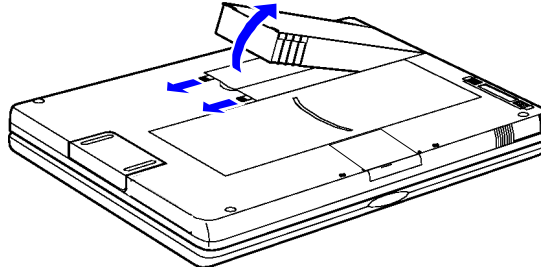

4. Insert the new battery pack so the metal battery contacts on the pack line up with the contacts in the compartment, then latch the cover. If you replace the battery within 1 minute, your current work session will be saved. (Saved files and data are not affected.)
5. If you have changed the battery very quickly, you might need to turn off the computer, then press F4+On/Off to turn it on and update the battery status indicator.

Caution

Do not mutilate, puncture, or dispose of the battery in fire. The battery can burst or explode, releasing hazardous chemicals. A rechargeable battery pack must be recycled or disposed of properly.

Controlling Battery Power

The OmniBook uses Advanced Power Management (APM) to conserve battery power. You can take steps to optimize your battery operating time.

In this section you'll learn how to

- [Respond to a low-battery warning.](#)
- [Save battery power.](#)
- [Change how power is managed.](#)

To respond to a low-battery warning

When battery power is critically low, the Battery indicator in the Status Panel appears empty and a 2-minute warning appears on the display. The OmniBook automatically suspends (turns off) to preserve your current session as long as possible. You won't be able to turn it on again until you restore power by one of the following actions:



- Plug in the ac adapter. See ["To recharge the battery or run on ac power."](#)
—or—
- Replace the battery with one that's charged. See ["To replace the battery."](#)

Caution

If you don't restore power and you don't save your work before the OmniBook turns itself off, your work will be lost if the battery runs down completely—within as little as several hours after the warning.

A battery warning first appears in the middle of the screen. After acknowledgment, it appears in the Status Panel. The abbreviation in the warning indicates the meaning.

Battery Warnings

Warning	Meaning
<2:00	Low battery. Less than 2 minutes of battery life remain before automatic shut-down. Double beeps every 15 seconds remind you of this. Press ESC to acknowledge the message.
 NiMH	Bad battery: Wrong type. Install a lithium-ion (Li-ion) battery, <i>not</i> a nickel-metal-hydride (NiMH) battery.
 T	Bad battery: Cannot be fully charged. Replace the battery.
 V	Bad battery: Overcharged. The problem could be with either the battery or the computer. Try replacing the battery. If this does not work, contact Hewlett-Packard Support. See the <i>Support and Service</i> booklet, or check OmniBook Support in the OmniBook Library online.

To save battery power

You can follow these suggestions for conserving battery power.

- Plug in the ac adapter, especially while using the floppy drive, a CD-ROM drive, or any external connections.
- Turn down the brightness of the display to the lowest comfortable level. This reduces the backlight power, which can increase the battery operating time.
- Set power management to an option that emphasizes saving power. See [“To change how power is managed.”](#)
- If you work with an application that uses the serial port or an I/O card, exit the application when you’re done using it.
- If you have an I/O PC card—that is, a PC card having an external connection, such as a modem or network card—remove it when you’re not using it. Some I/O cards use significant power, even while they’re inactive.

To change how power is managed

You can change power-management settings that affect power usage and performance. For example, you can change automatic timeout settings. A larger timeout setting usually uses more battery power. For ideas about how to save battery power, see [“To save battery power.”](#)

- Run [HP User Tools](#) and click the OmniBook Power Management button on the Settings tab. You can change these power settings:
 - Automatic timeout settings.
- or–
- Save your work, then run the [System Configuration Utility](#) and use its Power menu. You can change these power settings:
 - Automatic timeout settings (rebooting is required).
 - Audio timeout setting (rebooting is required).

Note

Most OmniBook automatic timeout features operate only when the OmniBook is running on battery power. For example, if the ac adapter is powering the unit, the OmniBook does not automatically turn off.

4. Protecting Your OmniBook

- [Attaching a Security Cable.](#)
- [Setting Up Password Protection.](#)
- [Protecting Your Data.](#)

Your OmniBook provides several ways for you to identify and protect your computer.

Attaching a Security Cable

Your OmniBook has a built-in connector that allows you to secure the OmniBook with a cable. The Kensington MicroSaver lock system works with this connector and is available at many computer stores. The same lock works with an OmniBook docking system.

To attach a security cable

1. Wrap the cable around a stationary object, such as a table leg.
2. Loop the cable to create a slip knot around the stationary object. Make sure it can't slip off.
3. Insert the lock into the OmniBook security connector and release the key. *Store the key in a safe place away from the OmniBook.*

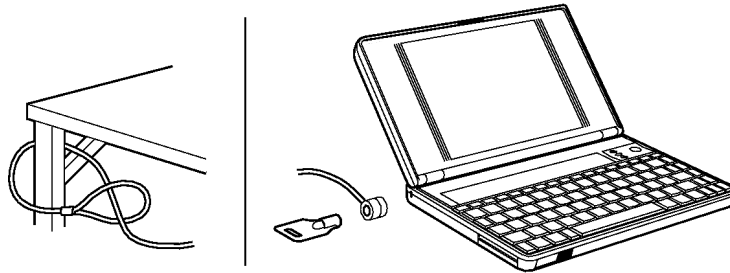

Setting Up Password Protection

You can protect your OmniBook against unauthorized use by activating password security. You can create a user password for normal protection against unauthorized use. You can also create an administrator password for a system administrator or as a backup for the user password. Or your system administrator might set up this password.

In this section you'll learn how to

- [Record your name for identification purposes.](#)
- [Set up password security.](#)
- [Delete a password.](#)

To record your name or other PC identification

By recording your name and other information, you identify your OmniBook and make a record of purchase information that will be handy if you have to contact Hewlett-Packard for support or service or if you lose your OmniBook. Your personal information is displayed each time you reboot the OmniBook.

- Run [HP User Tools](#) and click the OmniBook PC Identification button on the Information tab.
- or–
- Run the [System Configuration Utility](#) and use its System menu PC Identification command (rebooting is not required).

You can secure the PC identification with a password. See the next topic.

To set up password security

If you activate password security, you must enter the password in certain situations. This prevents unauthorized access to your OmniBook. The following types of protection are available:

- **Turn-on protection.** Prevents an unauthorized person from turning on the computer and accessing your work. You can choose to always require the password at turn-on (even after automatic turn-off), or you can require it only after you do a “secure” stop (pressing FN+On/Off).

Note that using this option with an external keyboard (such as with a docking system) results in a reboot as well as a password lock. This is because FN maps to CTRL+ALT on an external keyboard, and CTRL+ALT+OFF turns off the OmniBook and reboots it.

- **Undocking protection.** Prevents an unauthorized person from removing the computer from a docking system.
- **Hard disk drive protection (“drive lock”).** Prevents an unauthorized person from accessing your data after removing the hard disk drive from your computer and installing it in another computer. (Your user password serves as the drive’s password. The user password for the other computer must match the drive’s

password to access the data.) Don't use hard disk drive protection if you frequently swap drives between computers.

- **PC identification protection.** Prevents an unauthorized person from changing your identification stored in the computer.
- **Separate user and administrator passwords.** The user password is the general password for most types of protection. The administrator password can serve as a backup for the user password—you can enter it any time the user password is requested. The administrator password can provide setup and PC ID protection, and you can use it to change or delete the user password.

Hint

Before you type a password, check the status of Num Lock in the Status Panel. Normally, you'd want it off so you can type letters.

Use the following steps to set up password security.

1. Run the [System Configuration Utility](#) and use its System menu Passwords commands.
2. Choose to set a user or administrator password according to the table below. The password can contain up to eight characters. The display shows * for each character in your password. After you type the password, press TAB and type it again in the Verify box.
3. Set or clear the password options you want according to the table below.

Type of Protection	Steps
Turn-on protection	<ol style="list-style-type: none">1. Set a user password.2. Select one of the "turn-on" options.
Undocking protection	<ol style="list-style-type: none">1. Set a user password.2. Select the "undock" option.3. Connect a Kensington lock to the dock (to prevent manual undocking).
Hard disk drive protection	<ol style="list-style-type: none">1. Set a user password.2. Select one of the "turn-on" options.3. Make sure the "disable drive lock" option is unchecked.
PC ID protection	<ol style="list-style-type: none">1. Set an administrator password.2. Select the "PC Identification" option.

Caution

Be sure you record your password in a safe place. To restore operation if you forget your password, have your proof-of-purchase handy and call Hewlett-Packard at the number in the *Support and Service* booklet.

Hint

Hard disk drive protection. When moving a password-protected hard disk drive to another OmniBook, do one of the following:

- Remove user password protection before transferring the hard disk drive to another OmniBook, or
 - Set the user password of the new OmniBook to match the current password on your hard disk drive.
-

To delete a password

1. Run the [System Configuration Utility](#) and use its System menu Password commands (rebooting is not required).
2. Choose to set the user or administrator password, whichever one you want to delete.
3. When prompted, type your old password, but leave the new password empty and exit.

Hint

Turning off password protection. In the System Configuration Utility, you can clear all of the password options. This retains your password, but it's never invoked.

Protecting Your Data

As you create or add information on your OmniBook, the need to make backup copies of that information becomes more important. By making backup copies of key files, you can reduce the chance of accidentally losing that data. You can back up individual files to floppy disks using the Windows File Manager. For more elaborate backup storage, you might need to obtain one of the many commercially available software packages.

Caution

If you swap the hard disk drive in your OmniBook, carefully follow the steps in the *Installation and Setup Guide*. In particular, make sure you shut down Windows, unplug the ac adapter, and remove the battery from the OmniBook before you remove the drive. Otherwise, data on the drive could be corrupted.

To repair and clean up a disk

After a period of use, the file structure on a disk may develop corrupted sections or disjointed files, causing errors or slightly longer response time in some situations. If you clean up the disk every few months or so, you can optimize your disk's operation.

- Use the disk-scanning and disk-defragmenting utilities provided by your operating system.

Caution

Back up your files periodically, especially before doing maintenance.

For Windows 95, you can follow these steps:

1. Plug in the ac adapter.
2. Click Start, Programs, Accessories, System Tools, Disk Defragmenter to optimize the use of space on a disk.
3. Select the drive you want to defragment.
4. If Disk Defragmenter finds errors on the disk, you can click Start, Programs, Accessories, System Tools, ScanDisk to repair disk errors.

5. Using the Personal Information Applications

- [Managing Your Time with Appointment Book.](#)
- [Listing People in Phone Book.](#)
- [Getting Answers from HP Financial Calculator.](#)

This chapter introduces three applications to help you keep track of things—meetings and appointments, addresses and telephone numbers, personal records and finances—to mention just a few.

Hint

Appointment Book (and Phone Book) keeps the working file open, and it updates the file for each change you make. Follow these suggestions to prevent accidental damage to your appointment and phone files:

- Exit Appointment Book and Phone Book when you're not using them or before you turn off your OmniBook. If Appointment Book or Phone Book is open and your OmniBook has an unexpected problem, it could corrupt the current appointment file or phone file.
 - Open only files that reside on drive C, not on a removable disk. An open file on a removable disk (such as a floppy disk or PC card) is susceptible to corruption in certain situations.
-

Managing Your Time with Appointment Book

Appointment Book in your OmniBook is the perfect replacement for that old pocket calendar or bulky scheduler you may have used in the past. Appointment Book helps allocate your time, and is as easy to use as other Windows applications. Here are some of the ways to put Appointment Book to work:

- View your daily, weekly, or monthly calendar at a glance.
- Quickly add and delete appointments.
- Use your OmniBook to signal the next appointment.
- Keep detailed records of past appointments kept and tasks performed.
- Print a copy of your schedule for others.

This section shows selected features of Appointment Book, and briefly illustrates how to make and delete an appointment.

To start Appointment Book

- Click Start, Programs, OmniBook, and Appointment Book.

To view your appointments

- Click the Day button on the Toolbar.

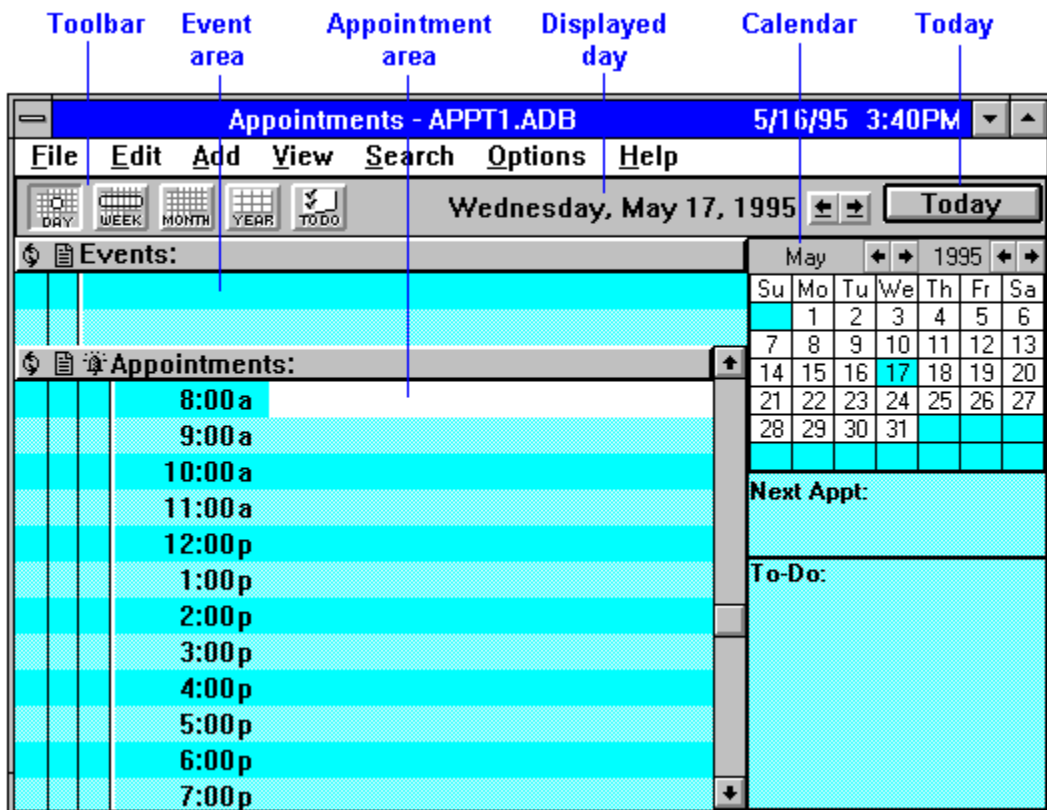

To change to a different day, month, or year

- Click the desired day, month, or year in the Calendar.

To add a new appointment

1. If necessary, click the day in the Calendar to display the day of your new appointment.
2. Click the mouse on the line next to the desired time in the Appointment area. Double-click to open the Add Appointment/Event box.
3. Type a description of the appointment.
4. Press ENTER or click OK to create the appointment. (Click SAVE to save the appointment and create another one.)

Type the appointment description.

Change the start or end times as needed.

The screenshot shows the 'Add Appointment / Event' dialog box. It contains the following elements:

- Description:** A text input field.
- Type:** Radio buttons for 'Appointment' (selected) and 'Event'.
- Start Time:** A time picker set to 8:00AM.
- End Time:** A time picker set to 8:00AM.
- Start Date:** A date picker set to 5/17/95, with a 'Calendar...' button.
- Number of Days:** A spinner set to 1.
- Location:** A text input field.
- Alarm Enabled:** A checked checkbox.
- Leadtime:** Spinners for hours (0) and minutes (5).
- View in Month:** A checked checkbox.
- View in Week:** A checked checkbox.
- Repeat:** A box containing 'Repeat: None' and a 'Change Repeat...' button.
- Note:** A text area with scrollbars.
- Buttons:** 'Save', 'OK', 'Cancel', and 'Help' at the bottom.

Select or clear the alarm option.

When the OmniBook signals an appointment, it displays a dialog box to signal the alarm, even if you have exited Appointment Book or are working in another application. If the OmniBook is off, it turns on to display the box and signal your alarm.

To add a new event

Events (like holidays and anniversaries) are special days you don't want to forget.

1. If necessary, click the Day button to display and change to the day of your new event.
2. Click the mouse on the top blank line *in the Event area*. You see the highlight move there.
3. Type a description of the event.
4. Press ENTER to add the event.

To delete an appointment or event

1. Click the appointment or event to move the highlight there.
2. From the Edit menu, select Delete to delete the appointment or event.

Appointment Book saves every change to your schedule for you *as you make it*. So if for some reason you decide to exit the Appointment Book application, you don't need to worry about saving changes first.

To run a program automatically

- Create an appointment whose Description field starts with | followed by the command line. For example, to run a batch file called BACKUP (in directory MYFILES) at 1:00 a.m., set an appointment for 1:00 with this Description field:

```
|C:\MYFILES\BACKUP.BAT
```

Listing People in Phone Book

Phone Book is another valuable part of your portable OmniBook. It is actually a personal database containing names, addresses, and—most important—telephone numbers, all ready for handy reference. You can add entries, delete them, search for a specific name, or even search for specific text. This section gives a brief introduction into using Phone Book.

To start Phone Book

- Click Start, Programs, OmniBook, and Phone Book.

To add a person to the list

1. Double-click a blank line in the display area.
—or—
Press F2.
2. In the Name box, type a person's name—for example, "Martin, Jean-Claude."

Remember to type the last name first, because when you sort or search the list of items, the operation begins by looking at the leftmost character. Putting last names first will make it easier to find people later.

Type the last name first. Names are sorted alphabetically.

Add New Item			
Name	Martin, Jean-Claude		
Phone: Business	444-6688	Home	
Alternate		Fax	444-6689
Title	Ski instructor	Category	business
Company	La Nieve Profonde		
Address1	4387 Schussboomer Street		
Address2			
City	Hidden Valley	State	CO
Zip	53409		
Note			
Save OK Cancel Help			

3. Type information in the rest of the Add New Item box. See the hints below.
4. Click OK or press ENTER to enter the item into the list.

–or–

Click Save to enter the item into the list and open a new, blank item. This is a good way to add several items to the list, one after another.

When you add new persons to the list, they're automatically placed in alphabetical order.

Hints

- For ease of typing, you can use the TAB key to tab between fields. (SHIFT+TAB tabs backwards.)
 - The Category entry allows you to sort your list into sections for relatives, personal acquaintances, business contacts, and so on.
 - You can leave almost any field blank.
-

To search for a person

1. Type the first letters of the name you want to find. When you start typing a name, Phone Book's Fast Goto dialog box pops up and searches as you type. The highlight moves to the name as you type it.
2. When the highlight is on the name you want, press ENTER to close the Fast Goto dialog box.

Getting Answers from HP Financial Calculator

HP Financial Calculator gives you all the power and convenience of a full-fledged Hewlett-Packard handheld calculator. It lets you quickly perform mathematical operations, as well as sophisticated financial and scientific calculations. Here's a sample of what you can do with this handy OmniBook application:

- Perform general arithmetic problems involving addition, subtraction, multiplication, and division.
- Execute sophisticated TVM (time value of money) and financial calculations.
- Produce analyses of financial alternatives.
- Do conversions involving currency, length, temperature, and other units.
- Perform calculations using scientific functions like sine, cosine, polar/rectangular functions, and more.
- Solve algebraic equations with the Solver.
- Switch between conventional algebraic mode and the RPN (Reverse Polish Notation) familiar to many HP calculator users.

Attention HP Calculator Veterans

If you've already used another Hewlett-Packard calculator like the HP 19BII or the HP 200LX's Calculator, you'll find HP Calculator remarkably similar. But now you can press buttons on the keyboard or click buttons in the HP Calculator window to accomplish the same tasks.

To start HP Calculator

- Click Start, Programs, OmniBook, and HP Financial Calculator.

To perform a math function on one number

1. Type the number. The number appears in the Calc line.
2. Click the button for the desired math function.

—or—

Press the key on the OmniBook keyboard corresponding to the desired math function.

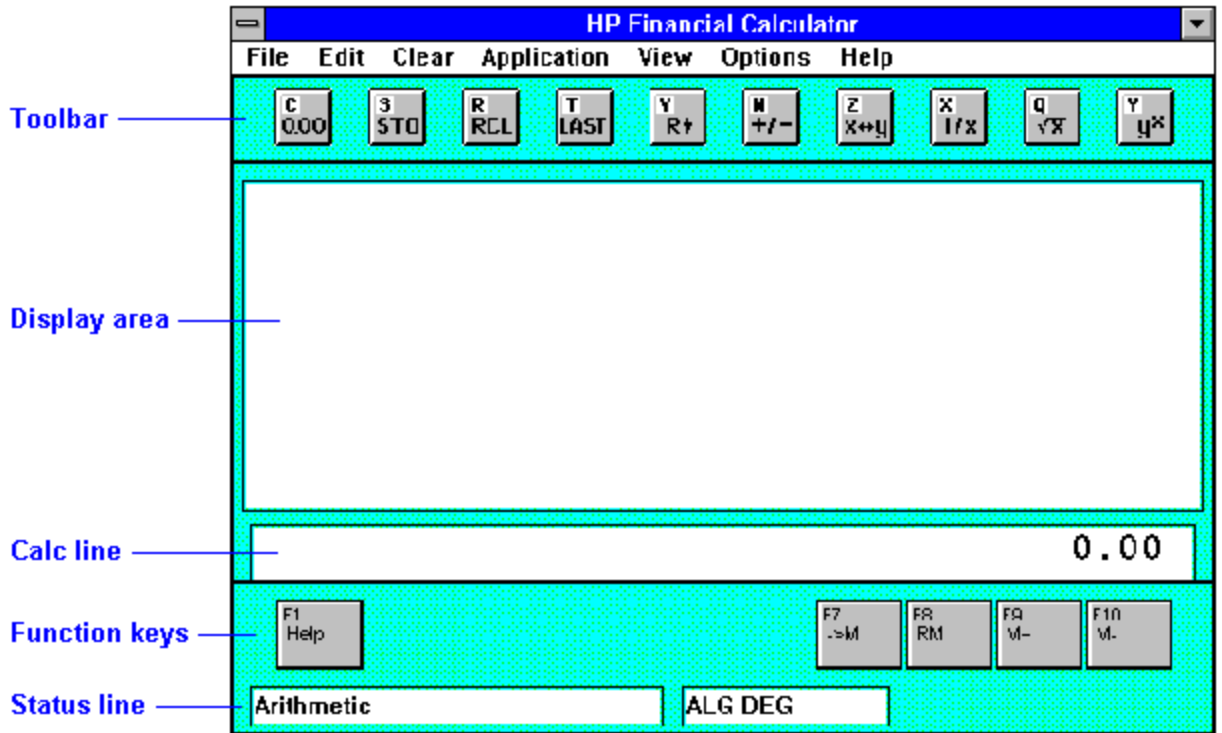

HP Calculator “takes over” part of your OmniBook’s keyboard and reassigns functions to it. You can see these functions and the applicable keys on the display of calculator buttons—for example, pressing the Q key takes the square root of the number in the Calc line.

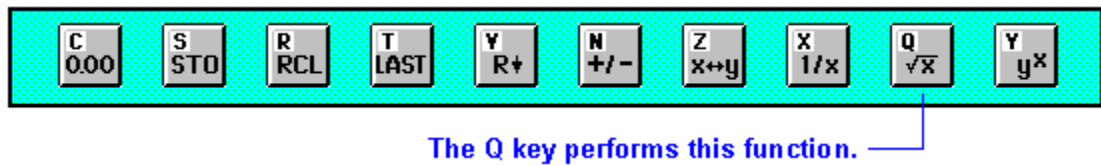

Hints

Use BACKSPACE to correct a single keystroke on the Calc line.

Use DEL to erase the entire Calc line and reset it to zero.

To do simple arithmetic

1. Type the calculation in the Calc line.
2. Press ENTER (or the = key).

Your OmniBook’s HP Calculator application starts in algebraic mode, shown by the letters ALG in the status line. When algebraic mode is active, you can type a number into the Calc line, then type an arithmetic operator like +, then type another number and press ENTER or the = key to see the answer.

If you are entering a multi-step problem, intermediate results are calculated when you type the next arithmetic operator. You can also type parentheses to group different parts of a calculation.

6. Changing the Configuration

- [Using HP User Tools.](#)
- [Using the System Configuration Utility.](#)
- [System Resources.](#)

You can use the System Configuration Utility (SCU) or the Tools application to change OmniBook configuration settings. The SCU provides more options for certain settings.

The following chart summarizes the OmniBook settings you can change. See the sections of this chapter for details. To change any settings not accessible using this software, try using Windows Control Panel.

Settings	HP User Tools	SCU
Display, keyboard, mouse		
Display switching	x	x
Keyboard setup		x
External keyboard setup	x	x
External mouse setup	x	x
Status Panel setup	x	x
Power management		
Timeout setup	x	x
Advanced power setup		x
Port activity	x	x
Connections		
COM port setup		x
Printer port setup		x
IrDA setup		x
Security		
Password setup		x
PC identification	x	x
Hard disk security		x
Other		

Date and time		x
Sound volume		x
Boot setup		x
Cache setup		x
Memory size	x	x
BIOS version	x	x

Using HP User Tools

HP User Tools give you a convenient way in Windows 95 to change the way your OmniBook looks and operates. For many settings, it's an alternative to using the System Configuration Utility.

To run HP User Tools

1. Click Start, HP User Tools.
2. Click the tabs and buttons for the changes you want to make. You're prompted if you need to reboot the computer. Click Help or see the table below for more information.
3. After you make the changes, exit HP User Tools.

Settings	
OmniBook External Devices	<p>HP OmniBook Display:</p> <p>Sets whether the built-in display is on or off when an external display is present. Also can override automatic detection of an external display. (You can press FN+PrtSc at any time to cycle among the different display combinations.)</p> <p>External Input Devices:</p> <p>"Enable External FN Key" lets you press CTRL+ALT instead of FN on an external keyboard with no FN key.</p> <p>"Ignore External Pointing Device" activates the built-in mouse when an external mouse is connected.</p>
OmniBook Status Panel Setup	<p>"Disable Status Panel" sets whether the Status Panel can be displayed.</p> <p>"Position" sets the corner of the display where the Status Panel appears.</p> <p>"Show Status Of" sets when each indicator appears in the Status Panel.</p>
OmniBook Power Management	<p>"Options for Battery Power" balances the tradeoffs between power savings and performance speed while operating on battery power. Click Custom to set timeouts individually.</p> <p>"Idle Time Before Turn-Off" shows the individual timeouts.</p> <p>"Auto Turn-off on AC" sets whether the computer turns off when the ac adapter is connected.</p> <p>"Port Activity" lets you select ports that don't override automatic turn-off.</p>
Control Panel	Opens the Windows Control Panel for changing other settings.
Library	Opens the OmniBook <i>User's Guide</i> and other online sources of

information.

Information

License Agreement	Shows the HP software license agreement.
OmniBook Support	Shows how to get support for the OmniBook.
OmniBook System Information	Shows the BIOS version and the amount of system memory.
OmniBook PC Identification	Lets you define four text strings for name, title, company, address, phone, etc. The text appears each time the computer restarts.
OmniBook Password Status	“User Password Required” shows whether a password is required when the computer starts, or before undocking. “Admin Password Required” shows whether PC ID changes are protected by the administrator password. Use the SCU to change the password status.
Resource Allocation	Shows resource settings for I/O devices.

Using the System Configuration Utility

The System Configuration Utility (SCU) provides access to basic configuration settings. It is independent of the operating system.

To run the SCU

1. Close all applications, then shut down Windows and reboot the OmniBook. If necessary, you can press CTRL+ALT+DEL to reboot.
2. During reboot, at the message "<F2> to enter System Configuration Utility," press F2 to start the SCU.
3. The mouse is not active in the SCU. Press ALT to activate menus, and use arrow keys, spacebar, ENTER, and ESC to navigate and change settings. See the tables below for more information.
4. After you select the options you want, use the Exit menu to close the SCU.

System menu

Date and Time	Sets the date and time.
Boot Devices	Boot Device "FDD First" is the typical PC boot, where drive A is searched first for a system disk, then drive C. "HDD Only" boots the computer from drive C only. Provides protection from boot-sector virus. PC Card Mode "Legacy" configures the PC card slots as standard PCMCIA slots. "Disable" allows a PnP operating system to configure the card slots. "CardBus" configures the card slots as CardBus slots. Boot Configuration "Full" configures all devices at boot time. Compatible with a non-PnP operating system. "Boot devices only" configures all devices at boot time except PnP ISA cards set up as boot devices. Compatible with a PnP operating system, which configures such cards. "Auto-detect" performs a boot-device-only or full configuration, depending on whether the operating system last used was PnP or not. Fast Boot. Skips the RAM test. Force PCI Bridge configuration. Prevents certain versions of Windows NT from interfering with the PCI configuration.
Docking Messages	On or off. Provides prompts during docking and undocking.

Passwords	
Password options	<p>“User Password required” sets whether a user password is required when the computer turns on, or before undocking.</p> <p>“Administrator Password required” sets whether PC ID changes are protected by the administrator password.</p> <p>“Disable hard disk drive lock” sets whether a user password with turn-on security can secure data on the hard disk if the disk is moved to another computer.</p>
Set Admin password	The administrator password provides protection equal to the user password plus PC ID protection. The administrator password can be used whenever the user password is requested, such as when changing the user password.
Set User password	The user password protects user events selected in Password Options, but doesn’t give access to protected administrator options, such as PC ID.
PC Identification	Four text strings for name, company, address, phone, etc.
Enable Cache	Enables faster performance by using cache memory.
Status Panel Enable	On or Off. Sets whether the Status Panel can be displayed.
Status Panel Settings	
Status Panel Position	Sets the corner of the display where the Status Panel appears.
Items to Show	Sets when each indicator appears in the Status Panel.

Input/Output menu

COM Port	Sets serial port address and interrupt.
LPT Port	Sets printer port address and interrupt.
LPT Type	Sets printer port communication.
Keyboard Setup	<p>“Key Delay” sets how long you hold a key down before the character starts repeating.</p> <p>“Key Repeat Rate” sets how fast characters repeat.</p> <p>“Keyboard Numlock” sets whether Num Lock is active after rebooting.</p>
External devices	<p>“VGA Display device” sets whether the built-in display is on or off when an external display is present. (You can press FN+PrtSc at any time to cycle among the different display combinations.)</p> <p>“Force recognition of external VGA” overrides automatic detection of an external display. (You can press FN+PrtSc at any time to cycle among the different display combinations.)</p> <p>“Enable External FN Key” lets you press CTRL+ALT instead of FN on an external keyboard with no FN key.</p> <p>“Ignore External Pointing Device” activates the built-in mouse when</p>

	an external mouse is connected.
Audio Port	
Basic Audio	“Disable internal” turns off the internal sound chip, such as when using an external sound card. Sets the volumes for the beeper signal and the sound speaker.
Advanced Audio	Sets system resources used by audio devices.
Video Stretched	On or Off. Expands video so a VGA-size image fills the entire screen. (You can press FN+TAB at any time to change this.)
Enable IrDA IR	On or Off. Makes the infrared port compatible with the IrDA standard.

Power menu

Power Controls	“CPU Power Management” should be Maximum for greatest power savings. “Auto Turn-off w/Battery” and “HDD Power-down w/Battery” are automatic turn-off times. “Auto Turn-off w/AC” sets whether the computer turns off when the ac adapter is connected. “Enable audio power savings” lets the audio system turn off while it’s not busy.
Port Activity	Lets you select ports that don’t override automatic turn-off.

Defaults menu

Factory Default Settings	Resets all settings to defaults without exiting.
Restore Settings	Discards changes without exiting.

Exit menu

Save	Saves changes and exits.
Quit	Discards changes and exits.
Version Info	Shows the BIOS version.

System Resources

Below are default values for system resources. To see other, non-default possibilities, use the [System Configuration Utility](#), which lists port and audio device configurations in the Input/Output menu.

The tables in this section show typical resource usage as set up by the OmniBook BIOS. Plug-and-play operating systems, drivers, and SCU settings may change some of the entries.

Interrupts (IRQs)

0	System timer
1	Keyboard
2	programmable interrupt controller
3	Free (COM2 or COM4 if modem installed)
4	COM1 (external serial port)
5	ESS sound chip
6	Floppy-disk drive
7	LPT1 (external parallel port)
8	Real-time clock
9	Free
10	IrDA (infrared) and SCSI
11	Free
12	Pointing device
13	Math co-processor
14	Hard disk
15	Docking/PCI slot

A PC Card's IRQ depends on the card.

DMA Channels

0	Free
1	Sound
2	Floppy-disk drive
3	Free
4	DMA controller
5	Wave 2
6	Free

7	Free
---	------

System Memory

C000-C7FF	VGA BIOS
C800-CFFF	Free
D000-D1FF	PC Card memory for Windows 3.1
D000-E7FF	Free (except for the above)
E800-EBFF	Plug-n-Play BIOS
EC00-EF7F	PCI BIOS
EF80-EFFF	Enhanced Parallel Port BIOS
F000-FFFF	System BIOS

System Input/Output Addresses

1F0-1F7	Hard-disk drive
220-22F	ESS sound
2F8-2FF	COM 2 if modem installed
330-331	ESS sound
378-37F	LPT1 (external parallel port)
388-38B	ESS sound
3B0-3BB	Video adapter
3C0-3DF	Video adapter
3E0-3E1	PC Card bridge on PCI
3F0-3F5 (primary)	Floppy drive
3F6	Hard-disk drive
3F7	Floppy drive
3F8-3FF	COM1 (external serial port)
778-77A	LPT1 in ECP mode
3000-301F	IrDA (infrared)
3100-31FF	internal SCSI (SCSI cable attached)
4000-40FF	SCSI (docked without network card)
4100-41FF	SCSI (docked with network card)

I/O addresses 300, 310, 320, 340, and A20 are free for network cards.

7. Troubleshooting

- [Solving Problems.](#)

If you run into problems using your OmniBook, you can use the suggestions in this chapter for getting back on track. You can also check the contents and index for pointers to related information.

If you have questions that this manual doesn't answer, you can

- See the troubleshooting chapter in the OmniBook *Installation and Setup Guide* if you have problems that interfere with turning on or starting the OmniBook.
- Look at the online Help for Windows and other applications.
- Check with your computer system administrator, if you have one.
- Check your local library or bookstore for other books about Windows, MS-DOS, and other applications.
- Contact your dealer, or contact Hewlett-Packard. See the OmniBook *Support and Service* booklet or open OmniBook Support in the online OmniBook Library.
- Click Start and Help to use the Windows "troubleshooters" provided for several types of common problems. On the Contents tab, open the Troubleshooting book, then start the desired troubleshooter.

Solving Problems

This section separates problems into the following categories:

- [Printing problems.](#)
- [Memory problems.](#)
- [Mouse problems.](#)
- [File, drive, and PC card problems.](#)
- [Communications problems.](#)
- [Sound problems.](#)
- [Display problems.](#)
- [Power problems.](#)
- [Lockup problems.](#)

Printing Problems

Hint

For most printing problems, use the Print Troubleshooter in Windows Help.

If a serial printer doesn't print

- Check that you're using a proper cable or cable adapter.

If an infrared printer doesn't print

- If you're printing to an infrared printer, make sure its port is set to LPT3 (not LPT1). Check the printer's settings. You can also try using COM4 instead.
- Start Infrared Monitor before you print.
- In the Printers window, select the printer and make sure Work Offline is not marked in the File menu.
- In Windows Help, use the Print Troubleshooter.
- For infrared printing from an MS-DOS program, run the program in an MS-DOS window instead of in MS-DOS mode.
- Make sure the infrared light path is not blocked.
- Move the devices to within about 1/2 meter (1.5 feet).
- Make sure Windows is running—infrared printing is supported only while Windows is running.
- Make sure the infrared printer is IrDA compatible.
- Make sure you have not disabled IrDA support on your OmniBook.

If a parallel printer doesn't print

- In the Printers window, select the printer and make sure Work Offline is not marked in the File menu.
- Make sure the printer port and the audio port do not use the same interrupt value.

If the left edge of printed output is missing

- If the printer you're using is a 600-dpi (dots per inch) printer, try selecting a compatible printer driver for a 300-dpi printer. For example, for a 600-dpi HP LaserJet printer, try using the HP LaserJet IIIsi driver (300-dpi). Certain applications may not work properly with 600-dpi printers.

Memory Problems

If a message says you're out of memory

To find out how much memory is in your OmniBook, run [HP User Tools](#).

- In Windows Help, use the memory troubleshooter.
- If you're having memory problems running MS-DOS programs, in Windows Help use the MS-DOS troubleshooter.

Mouse Problems

If the pointer is difficult to control

- Adjust the pointer settings using the Mouse icon in Control Panel.

If the OmniBook mouse doesn't work

- Make sure you don't have an external mouse connected. If you do, you can still return control to the OmniBook mouse by ignoring the external mouse:

In HP User Tools, click Settings, OmniBook External Device.

If the mouse doesn't work in MS-DOS

- Use the special MS-DOS Mode command. Click Start, Programs, OmniBook, MS-DOS Mode. This shuts down Windows and loads drivers for MS-DOS. When you're done, type **exit** to restart Windows.

If a mouse connected to the serial port doesn't work properly

- Set up the serial mouse manually. In Control Panel, double-click Add New Hardware and follow the instructions on the screen. Keep the serial mouse connected when you restart the OmniBook.
- Check whether the serial mouse is compatible with the OmniBook—the mouse must be compatible with the 9-pin serial Microsoft Mouse.

File, Drive, and PC Card Problems

If a PC card doesn't work properly in a card slot

For information about compatible cards, visit our Web site at <http://www.hp.com/go/omnibook>. Or contact Hewlett-Packard as described in the *Support and Service* booklet or in OmniBook Support in the online OmniBook Library.

- Try removing and reinserting the card.
- Try inserting the card in the other card slot to check the connector.
- Try removing a PC card from the other card slot, if another card is present.
- For a data storage card, check that you're using the correct drive letter.
- If a data storage card doesn't work properly, check if it has a write-protect switch and that it is set properly.
- Shut down Windows, then [reset](#) the OmniBook.
- If a modem card doesn't work properly, in Windows Help use the modem troubleshooter.
- In Windows Help, use the PC card troubleshooter.
- In Device Manager, check the settings for the PC card. Look for conflicts with other devices.

If the OmniBook doesn't reboot successfully from drive A

- If the OmniBook can't reboot from drive A, use the [System Configuration Utility](#) to check that the floppy drive is the first boot device.

If drive C has problems

- Insert the *Support Utility* floppy disk in the floppy drive, then press CTRL+ALT+DEL to reboot from drive A. You can use commands on the floppy disk to check and possibly repair drive C.

If a CD isn't automatically detected when inserted in a drive

- Use Device Manager to view the CD-ROM drive properties. Select the auto-detect setting. **WARNING:** This setting prevents the OmniBook from automatically suspending after a period of inactivity if the CD-ROM drive is present.

If the hard drive turns off prematurely (not matching your setting for hard-drive turn-off)

- There are two separate settings that affect hard-drive turn-off, and the shorter one will prevail.
- Check and set these two values to be the same:
 - HP User Tools, OmniBook Power Management, Idle Time Before Turn-Off, Hard Disk; and
 - Control Panel, Power, Disk Drives, When Powered by Batteries.

If a backup-tape drive does not work correctly

- Its bus speed might be too slow for the OmniBook. You can decrease the OmniBook's bus speed by pressing FN+MINUS. (To restore the normal speed, press FN+PLUS.)

Communications Problems

If you have problems with serial communications

- If a modem doesn't work properly, in Windows Help use the modem troubleshooter.
- If you cannot make a serial connection at high speed (115K baud), try changing the Power Management setting in the [System Configuration Utility](#) to "Moderate" (from "Maximum").

If you have problems with infrared communications

- Move the devices to within about 1/2 meter (1.5 feet).
- Check that only one application is using the infrared port.
- Check that both devices are using the same protocol, such as IrDA.
- Make sure you're using the COM4 port. (For printing, use the LPT3 port instead.)
- Start Infrared Monitor before you connect. In Control Panel, double-click Infrared.
- For an MS-DOS program using an infrared connection, run the program in an MS-DOS Prompt window instead of in MS-DOS mode.
- Try restarting Windows.

If an application can't access a serial port

- Check that the COM name you're using is actually assigned to the port you're using.

- If an application doesn't support the COM port number assigned, change the port number in the [System Configuration Utility](#).
- Check whether another application is preventing access to the port, even if it's not actively using it.
- Check in the communications application that you haven't changed the address and interrupt for the OmniBook port.

If the OmniBook stops responding after accessing a serial port

- If the OmniBook stops working, try pressing the On/Off key to suspend and turn on the OmniBook.
- [Reboot](#) the OmniBook.

If an I/O card stops communicating properly

- It may have been reset if the OmniBook suspended or turned off. Exit and restart the application, and plug in the ac adapter, if possible.

If a parallel device doesn't work correctly

- Its bus speed might be too slow for the OmniBook. You can decrease the OmniBook's bus speed by pressing FN+HYPHEN (minus). To restore the normal speed, press FN+EQUAL (plus).

Sound Problems

If sounds aren't audible

- Check the playback or recording sound levels, channels, and muting. See "[Using Sound](#)."
- Check the configuration of the sound card for system-resource conflicts.
- If you're running an MS-DOS program outside Windows and you need access to sound and other system devices, use the special MS-DOS Mode command:
Click Start, Programs, OmniBook, MS-DOS Mode. This shuts down Windows and loads drivers for MS-DOS. When you're done, type **exit** to restart Windows.
- If you add a Zoomed Video PC card (it must be in the upper card slot), its sound capability will not work until you activate Zoomed Video sound. While Zoomed Video sound is turned on, normal sounds related to PC card activity are disabled. Click Start, Programs, OmniBook, OmniBook Zoomed Video, then turn Zoomed Video sound on or off.

If the volume keeps reverting to old settings

- The FN-key volume and mute controls are effective for the duration of the current audio file only. Use the Windows volume controls to make a permanent change.

Display Problems

If the display works improperly

- Check whether the display resolution is set to its default setting, 800 x 600 (SVGA).

You can use Control Panel.

- Try changing the display resolution to the standard VGA option.

If the screen is difficult to read

- Try adjusting the display controls.
- If the OmniBook is cold, allow it to warm up.

If the display scrolls when the pointer reaches the edge

- A high-resolution display setting is active. You can use a high-resolution external display and turn off the OmniBook display by pressing FN+PrtSc, or you can choose the default OmniBook display setting.

If an external display doesn't work

- Press FN+PrtSc several times to switch among the different built-in and external display combinations.
- Force the OmniBook to send video output to the external display.

In HP User Tools, click Settings, OmniBook External Devices, then enable Force External Display.

If an image is cropped when displayed on an overhead projector

- Press FN+TAB once or more to change the position of the VGA-sized screen.

Power Problems

If you have power problems that interfere with turning on or starting the OmniBook, see the troubleshooting chapter in the OmniBook *Installation and Setup Guide*, which came with the OmniBook.

If the battery runs down too fast

- Make sure you charge the battery until the Status Panel shows a full battery. The charging light changes from orange to green when the battery is only about 90% charged.
- Try conserving power using any of the suggestions listed under ["To save battery power"](#)
- Check your power management settings using the [System Configuration Utility](#).
- If the operating time has gotten shorter and the battery pack is more than a year or two old, you may need a new battery pack.

If the OmniBook turns off immediately after it turns on

- Battery power is probably extremely low. Plug in the ac adapter, or make sure the OmniBook isn't turned on and insert a fresh battery—see ["To replace the battery."](#)

If the OmniBook doesn't suspend automatically

- If the ac adapter is connected, the OmniBook doesn't suspend.
- If you have a connection to another computer, the OmniBook doesn't suspend if the connection is actively in use.
- Check your power management settings using the [System Configuration Utility](#).
Check the port activity settings to make sure a device doesn't prevent the OmniBook from suspending. If a device interrupt is cleared, any activity for that device can prevent automatic Suspend.
- If Infrared Monitor is running, the OmniBook doesn't suspend if automatic searching is active. In Infrared Monitor, check the status of the search option.
- If you have a CD-ROM drive connected, use Device Manager to view the CD-ROM drive properties. If the auto-detect setting is active, it prevents the OmniBook from automatically suspending after a period of inactivity while the CD-ROM drive is present.

If the OmniBook suspends when you don't expect it

- Check your port activity settings using the [System Configuration Utility](#). If a device interrupt is marked, any activity for that device does not prevent automatic Suspend. However, keep in mind that related activity, such as hard disk activity, does prevent automatic Suspend.

If the OmniBook doesn't turn on

- Connect the ac adapter.
- Press the blue On/Suspend button to try turning on the unit.
- Try adjusting the display.
- [Reboot](#) the OmniBook.

If you get no response, remove the battery and ac adapter and press the reset button again—then install the battery or plug in the ac adapter and try resetting again.

If the OmniBook doesn't turn on with a fresh battery

- If you replaced the battery after the OmniBook turned off due to a low battery, either plug in the ac adapter or press F4+ON to turn on the OmniBook.
- If the new battery pack is low, plug in the ac adapter.

If the OmniBook doesn't suspend immediately

- If the OmniBook is performing an operation, it normally waits for the operation to finish.
- If you're using MS-DOS Prompt in the full screen (not inside a window), it may take up to 10 to 15 seconds to suspend.

If the OmniBook reboots every time you turn it on

- This is normal if you turn it off by pressing CTRL+ALT+On/Off.
- Advanced power management (APM) may be disabled. Check your power management settings using the [System Configuration Utility](#).

If the battery pack doesn't charge or stops charging

- Check that the battery is fully installed and locked in place.
- Turn off the OmniBook, then check that the battery contacts are clean and that the ac adapter cables are fully plugged in.
- Move the OmniBook away from any nearby heat source. Unplug the ac adapter and allow the battery to cool down. An elevated battery temperature prevents charging.
- A battery that is completely discharged can require several hours to recover and start charging.

If your OmniBook password doesn't work

- Check whether Num Lock is off. Try changing it.
- If you've forgotten your password, have your OmniBook at hand and call Hewlett-Packard at the phone number in the *Support and Service* booklet or in OmniBook Support in the online OmniBook Library.

If a boot ROM on a PCI card doesn't work

- You cannot use boot ROMs to boot off the server with a PCI network adapter. (You can do so with an ISA adapter.)

Lockup Problems

If you have problems that interfere with turning on or starting the OmniBook, see the troubleshooting chapter in the OmniBook *Installation and Setup Guide*, which came with the OmniBook.

If the OmniBook beeps repeatedly

- If two beeps occur every 10 seconds or so, battery power is critically low and less than 2 minutes of operation remain. Plug in the ac adapter, or turn off the OmniBook and insert a fresh battery—see ["To replace the battery."](#)

If an application stops responding

- Press CTRL+ALT+DEL, then stop the application.
- [Reboot](#) the OmniBook.

If a screen saver causes lockup

- If you've previously set up an OmniBook password, you should delete the OmniBook password. Screen savers conflict with password protection, and together they can lock up the OmniBook.

If you can't start Windows

- In the [System Configuration Utility](#), set Factory Default Settings in the Defaults menu.

—A—

- ac adapter
 - charging battery, 27
 - connecting, 27
 - preserves connections, 19
 - socket for, 6
 - status, 17
 - type, 27
- adding
 - appointments, 39
 - events, 40
 - phone entries, 41
- address resources, 53
- adjusting
 - brightness, 8
 - volume, 11
- admin password
 - deleting, 35
 - options, 50
 - setting up, 33
 - status, 48
- Advanced Power Management, 26
- alarms, 39
- ALT GR key, 14
- APM (Advanced Power Management), 26
- application FN keys, 14
- Appointment Book, 38
- appointments, 38, 39
- audio system
 - compatibility, 11
 - connections, 11
 - external jacks, 6
 - microphone, 11
 - troubleshooting, 59
 - turning off, 11
 - using, 12
 - volume, 11, 50

—B—

- bad battery warning, 30
- battery
 - brightness affects, 8
 - charge level, 26
 - charging, 27
 - charging light, 27
 - location, 6
 - low warning, 30, 50
 - operating time, 8, 28, 30
 - power settings, 31, 48, 50
 - RAM card, 24
 - replacing, 28
 - safeguards, 26
 - saving power, 30
 - status, 17, 26
 - troubleshooting, 60

- updating charge level, 26, 29
- warnings, 30
- beeping, 30, 62
- boot configuration, 50
- boot disks, 21
- brightness adjustment, 6, 8

—C—

- cable (security), 32
- cables
 - security lock, 34
- cache, 50
- Calculator, 43
- Caps Lock indicator, 17
- card slots, 6
- CardBus, 23
- card-eject lever, 6
- cards
 - inserting, 23
 - RAM, 24
 - removing, 25
 - troubleshooting, 57
- CD-ROM drive, 22
- charge indicator, 17
- charging
 - light, 27
 - starting, 27
 - status, 17, 26, 28
- charging light, 6
- cleaning up disks, 36
- collapsing the mouse, 10
- configuration settings, 46, 48, 50
- connecting
 - ac adapter, 27
 - floppy drive, 22
 - headphones, 11
 - microphone, 11
 - speakers, 11
- CTRL+ALT+DEL, 20
- CTRL+ALT+OFF, 19, 33
- cursor (pointer), 9

—D—

- data storage devices, 22
- defragmenting disks, 36
- deleting passwords, 35
- display
 - adjusting, 8
 - adjustment buttons, 6
 - brightness, 8
 - configuration settings, 48, 50
 - latch, 6
 - troubleshooting, 59
 - turning off, 19
- Display Off state, 20
- displaying

- appointments, 38
- Status Panel, 18
- DMA channels, 53
- docking messages, 50
- docking port, 6
- drive A
 - booting from, 21
 - location, 22
- drive C
 - booting from, 20
 - location, 22
 - repairing, 36
 - security, 33
 - status, 17
- drive letters, 22
- drive lock, 33, 50
- drives
 - connecting floppy drive, 22
 - repairing, 36
 - security, 33, 50
 - swapping, 36
 - troubleshooting, 57
 - types, 22

—E—

- events (Appointment Book), 40

—F—

- F1044 ac adapter, 27
- F1-F12 keys, 14
- F4+ON, 61
- F4+On/Off, 26
- files
 - troubleshooting, 57
- Financial Calculator, 43
- finding phone entries, 42
- floppy drive
 - booting from, 21
 - connecting, 22
 - drive A, 22
 - port, 6
- FN key
 - combinations, 13
 - external keyboard, 15, 48, 50
 - hot keys, 14
 - secure turn-off, 33
 - volume control, 11
- FN+ESC, 13
- FN+F1-F12, 14
- FN+HOME/END, 13
- FN+LEFT/RIGHT, 11, 13
- FN+ON, 13
- FN+On/Off, 33
- FN+PLUS/MINUS, 13, 59
- FN+PrtSc, 13
- FN+SPACE, 13
- FN+TAB, 13

- FN+UP/DOWN, 11, 13
- function keys, 14

—G—

- getting help
 - information sources, 4
 - online manual, 4

—H—

- hard disk
 - drive C, 22
 - drive status, 17
 - repairing, 36
 - security, 33
 - swapping, 36
- hard drive
 - troubleshooting, 57
- headphones, 11
- help
 - information sources, 4
 - online manual, 4
 - Windows, 16
- hiding Status Panel, 18
- hot keys, 14
- HP F1044 ac adapter, 27
- HP Financial Calculator, 43
- HP User Tools
 - comparison, 46
 - PC identification, 33
 - power settings, 31
 - summary, 48

—I—

- I/O addresses, 53
- icon strip
 - labels F1-F12, 14
 - printing, 14
- icons (Status Panel), 17
- identification, 33
- indicators (Status Panel), 17
- infrared port, 6, 58
- Installation and Setup Guide, 4
- installing
 - floppy drive, 22
 - PC cards, 23
- Instant On, 19
- interrupts, 53

—K—

- Kensington lock, 32, 34
- keyboard
 - external, 48, 50
 - F1-F12 label, 14
 - FN key, 13, 14, 15, 48, 50
 - hot keys, 14

- HP Calculator, 44
- numeric keypad, 13
- shifted keys, 14
- status, 17

—L—

- latch (cover), 6
- learning Windows, 16
- light (orange charging), 6, 27
- lockup problems, 62
- low battery
 - charging, 27
 - replacing, 28
 - warning, 30, 50

—M—

- math, 43
- memory
 - addresses, 53
 - amount, 48, 50, 56
 - troubleshooting, 56
- memory-expansion slot, 6
- microphone, 11
- MicroSaver lock, 32, 34
- mouse
 - calibrating, 10
 - customizing, 10
 - external, 48, 50
 - location, 6
 - PS/2 compatible, 9
 - replacing, 10
 - storing, 10
 - troubleshooting, 56
 - using, 9
- mouse-eject button, 6, 9
- moving the pointer, 9
- MS-DOS Mode, 59
- mute, 11

—N—

- networks
 - at turn-off, 19
 - information, 4
- Num Lock
 - indicator, 17
 - operation, 13
- numeric keypad, 13

—O—

- Off state, 20
- OmniBook
 - configuration settings, 46, 48, 50
 - identifying, 33
 - power states, 20
 - rebooting, 20

- resetting, 20
- turning display off, 19
- turning off, 19, 30
- turning on, 19

- On/Off key
 - location, 6
 - rebooting, 20
 - secure suspend, 33
 - suspend, 19
 - turn-on, 19
- online User's Guide, 4
- operating system, 4
- orange light, 27

—P—

- parallel port
 - location, 6
 - troubleshooting, 58
- passwords
 - admin, 33
 - deleting, 35
 - options, 33, 50
 - setting, 33
 - status, 48
 - user, 33
- PC cards
 - inserting, 23
 - removing, 25
 - saving power, 31
 - slots for, 6, 23, 25
 - troubleshooting, 57
 - types, 23
- PC identification, 33
- PCMCIA, 23, 25
- Phone Book, 41
- playing sound, 12
- pointer
 - customizing, 10
 - moving, 9
- popping out the mouse, 9
- ports, 6
- power
 - connecting ac, 27
 - saving, 30
 - settings, 31, 48, 50
 - status, 17
 - troubleshooting, 60
- power cord, 27
- power management
 - introduction, 26
 - settings, 31, 48, 50
 - status, 17, 26
- power states, 20
- printer problems, 55
- printing F1-F12 label, 14
- protection
 - identification, 33
 - passwords, 33

- security cable, 32, 34
- types, 33
- PS/2 compatibility, 9

—R—

- raising the mouse, 9
- RAM cards, 24
- rebooting
 - configuration, 50
 - from drive C, 20
 - from floppy drive, 21
- recharging battery, 27
- recording sound, 12
- removing
 - appointments and events, 40
 - battery, 28
 - passwords, 35
 - PC cards, 25
- replacing
 - battery, 28
 - mouse, 10
- reset button
 - location, 6
 - using, 20
- resources, 53

—S—

- saving battery power, 30
- scanning disks, 36
- Scroll Lock indicator, 17
- SCSI devices
 - at turn-off, 19
 - data storage, 22
- SCSI port, 6
- searching (Phone Book), 42
- security
 - attaching cable, 32, 34
 - cable connector, 6
 - identification, 33
 - passwords, 33
 - types, 33
- serial port
 - conserving power, 31
 - location, 6
 - troubleshooting, 58
- setting
 - configuration options, 46, 48, 50
 - passwords, 33
 - power options, 31
 - Status Panel options, 18
 - timeouts, 31
- shortcut (hot keys), 14
- Solver, 43
- sound
 - connections, 11
 - external jacks, 6
 - troubleshooting, 59

- turning off, 11
- using, 12
- volume, 11, 50
- Zoomed Video, 11
- Sound Blaster, 11
- speakers, 11
- Status Panel
 - charge status, 28
 - configuring, 18, 48, 50
 - displaying and hiding, 18
 - indicators, 17
 - moving, 18
 - power status, 26
- stereo input, 11
- storing the mouse, 10
- Support Utility disk, 21
- Suspend state
 - description, 20
 - low battery, 30
- swapping drives, 36
- System Configuration Utility
 - comparison, 46
 - passwords, 34
 - PC identification, 33
 - power settings, 31
 - summary, 50
- system disks, 21
- system resources, 53

—T—

- timeouts
 - not for ac, 31
 - setting, 31, 48, 50
- tour of Windows, 16
- troubleshooting, 4
 - display problems, 59
 - files and drives, 57
 - infrared problems, 58
 - lockup problems, 62
 - memory problems, 56
 - mouse, 56
 - PC cards, 57
 - power problems, 60
 - printing problems, 55
 - serial problems, 58
 - sound problems, 59
- turning off
 - automatically, 20, 30
 - manually, 19
 - secure, 33
- turning on
 - normally, 19
 - security, 33
- TVM (time value of money), 43
- typing
 - numbers, 13
 - special characters, 14

—U—

undocking security, 33
updates, 4
user password
 deleting, 35
 options, 50
 setting up, 33
 status, 48

—V—

VGA output, 6
viewing
 appointments, 38

volume
 adjusting, 11, 50
 muting, 11

—W—

warning (low battery), 30, 50
Web site, 4
Windows
 installing, 4
 learning about, 16

—Z—

Zoomed Video, 11, 23