HP OmniBook 3000

Reference Guide

Notice

This manual and any examples contained herein are provided “as is” and are subject to change without notice. Hewlett-Packard Company makes no warranty of any kind with regard to this manual, including, but not limited to, the implied warranties of merchantability and fitness for a particular purpose. Hewlett-Packard Co. shall not be liable for any errors or for incidental or consequential damages in connection with the furnishing, performance, or use of this manual or the examples herein.

Consumer transactions in Australia and the United Kingdom: The above disclaimers and limitations shall not apply to Consumer transactions in Australia and the United Kingdom and shall not affect the statutory rights of Consumers.

© Copyright Hewlett-Packard Company 1997. All rights reserved. Reproduction, adaptation, or translation of this manual is prohibited without prior written permission of Hewlett-Packard Company, except as allowed under the copyright laws.

The programs that control this product are copyrighted and all rights are reserved. Reproduction, adaptation, or translation of those programs without prior written permission of Hewlett-Packard Co. is also prohibited.

Portions of the programs that control this product may also be copyrighted by Microsoft Corporation, SystemSoft Corp., Crystal Semiconductor Corporation, Phoenix, and Neo Magic. See the individual programs for additional copyright notices.

Microsoft, MS, MS-DOS, and Windows are registered trademarks of Microsoft Corporation. Pentium and the Intel Inside logo are U.S. registered trademarks and MMX is a U.S. trademark of Intel Corporation.

For warranty information, see the *Support and Service* booklet.

Hewlett-Packard Company
Mobile Computing Division
19310 Pruneridge Ave.
Cupertino, CA 95014

HP Software Product License Agreement

Your HP OmniBook PC contains factory-installed software programs. Please read the Software License Agreement before proceeding.

Carefully read this License Agreement before proceeding to operate this equipment. Rights in the software are offered only on the condition that the customer agrees to all terms and conditions of the License Agreement. Proceeding to operate the equipment indicates your acceptance of these terms and conditions. If you do not agree with the terms of the License Agreement, you must now either remove the software from your hard disk drive and destroy the master diskettes, or return the complete computer and software for a full refund.

Proceeding with configuration signifies your acceptance of the License Terms.

Unless otherwise stated below, this HP Software Product License Agreement shall govern the use of all software that is provided to you, the customer, as part of the HP computer product. It shall supersede any non-HP software license terms that may be found online, or in any documentation or other materials contained in the computer product packaging.

Note: Operating System Software by Microsoft is licensed to you under the Microsoft End User License Agreement (EULA) contained in the Microsoft documentation.

The following License Terms govern the use of the software:

Use. Customer may use the software on any one computer. Customer may not network the software or otherwise use it on more than one computer. Customer may not reverse assemble or decompile the software unless authorized by law.

Copies and Adaptations. Customer may make copies or adaptations of the software (a) for archival purposes or (b) when copying or adaptation is an essential step in the use of the software with a computer so long as the copies and adaptations are used in no other manner.

Ownership. Customer agrees that he/she does not have any title or ownership of the software, other than ownership of the physical media. Customer acknowledges and agrees that the software is copyrighted and protected under the copyright laws. Customer acknowledges and agrees that the software may have been developed by a third party software supplier named in the copyright notices included with the software, who shall be authorized to hold the Customer responsible for any copyright infringement or violation of this Agreement.

Product Recovery CD-ROM. If your computer was shipped with a product recovery CD-ROM: (i) The product recovery CD-ROM and/or support utility software may only be used for restoring the hard disk of the HP computer with which the product recovery CD-ROM was originally provided. (ii) The use of any operating system

software by Microsoft contained in any such product recovery CD-ROM shall be governed by the Microsoft End User License Agreement (EULA).

Transfer of Rights in Software. Customer may transfer rights in the software to a third party only as part of the transfer of all rights and only if Customer obtains the prior agreement of the third party to be bound by the terms of this License Agreement. Upon such a transfer, Customer agrees that his/her rights in the software are terminated and that he/she will either destroy his/her copies and adaptations or deliver them to the third party.

Sublicensing and Distribution. Customer may not lease, sublicense the software or distribute copies or adaptations of the software to the public in physical media or by telecommunication without the prior written consent of Hewlett-Packard.

Termination. Hewlett-Packard may terminate this software license for failure to comply with any of these terms provided Hewlett-Packard has requested Customer to cure the failure and Customer has failed to do so within thirty (30) days of such notice.

Updates And Upgrades. Customer agrees that the software does not include updates and upgrades which may be available from Hewlett-Packard under a separate support agreement.

Export Clause. Customer agrees not to export or re-export the software or any copy or adaptation in violation of the U.S. Export Administration regulations or other applicable regulation.

U.S. Government Restricted Rights. Use, duplication, or disclosure by the U.S. Government is subject to restrictions as set forth in subparagraph (c)(1)(ii) of the Rights in Technical Data and Computer Software clause in DFARS 252.227-7013. Hewlett-Packard Company, 3000 Hanover Street, Palo Alto, CA 94304 U.S.A. Rights for non-DOD U.S. Government Departments and Agencies are as set forth in FAR 52.227-19(c)(1,2).

Edition History

Edition 1 September 1997



This manual is printed on recycled paper.

Contents

1. Introducing the OmniBook	1-1
Taking Inventory	1-3
Included in the OmniBook 3000 box	1-4
Models and configurations	1-5
Optional OmniBook accessories	1-5
OmniBook features	1-6
2. Setting Up the OmniBook	2-1
Setting Up Windows 95	2-3
To connect ac power	2-3
To run the Windows 95 Setup utility	2-4
Configuring the OmniBook	2-5
To run the BIOS Setup Utility	2-6
3. Getting Comfortable	3-1
Starting and Stopping the OmniBook	3-3
To turn the OmniBook on and off	3-3
To use OmniBook power modes	3-4
To reset the OmniBook	3-5
Using the OmniBook TouchPad	3-6
To control the pointer	3-7
To drag objects	3-7
To scroll without scroll bars	3-8
To configure the TouchPad	3-8
Using the OmniBook Display	3-9
To adjust the display	3-9
About TFT display quality	3-10
Using the OmniBook Keyboard	3-11
To use the Fn hot keys	3-12
To use the Windows 95 keys	3-13
To use the embedded keypad	3-13
Checking the Status of the OmniBook	3-14
To read the status panel indicators	3-14
To understand power and battery lights	3-16
Protecting the OmniBook	3-17
To set a password	3-17
To delete a password	3-18
To attach a security cable	3-19

4. Power Management	4-1
Monitoring Battery Power	4-3
To check the battery status	4-4
To respond to a low-battery warning	4-5
To recharge a battery	4-5
To replace the main battery	4-7
To install a secondary battery	4-8
Conserving Battery Power	4-9
To save battery power	4-10
To set time-outs	4-11
To handle and store the battery safely	4-12
To maintain and preserve battery life	4-12
5. Making Connections	5-1
Using OmniBook Plug-In Modules	5-3
To replace a plug-in accessory module	5-4
To install the floppy disk drive externally	5-5
To insert and eject a floppy disk	5-5
To insert or remove a CD	5-6
To use the CD-ROM drive safely	5-6
To open the CD-ROM drive manually	5-7
To install drivers for the Zip drive	5-7
To insert and eject a Zip disk	5-8
To eject a Zip disk manually	5-8
Connecting External Devices	5-9
To connect an external monitor	5-10
To enable the built-in and external displays	5-10
To change display settings in the BIOS Setup Utility	5-11
To connect a parallel device	5-11
To connect a serial device	5-12
To connect an external keyboard or PS/2 mouse	5-12
To connect Universal Serial Bus devices	5-13
To insert a PC Card	5-14
To remove a PC Card	5-15
List of tested PC Cards	5-16
To connect audio devices	5-17
To dock the OmniBook	5-18
To undock the OmniBook	5-20
To make an infrared connection	5-21
6. Expanding the OmniBook	6-1
Installing a Hard Disk Drive	6-3
To replace the hard disk drive	6-3
To replace the hard disk drive holder	6-4
To create a Hibernate partition	6-5

Installing RAM Expansion Modules	6-6
To install a RAM expansion module	6-6
To remove a RAM expansion module	6-8
7. Installing Software	7-1
Installing Drivers	7-3
Contents of the Recovery CD	7-4
To set up a PC Card or parallel port CD-ROM drive	7-5
To install an operating system	7-6
Recovering OmniBook Files	7-7
To install Windows 95 (factory-installation)	7-8
To install the online <i>User's Handbook</i>	7-9
To use the Recovery CD programming service	7-9
To replace a damaged Recovery CD	7-10
To update the OmniBook BIOS	7-10
8. Troubleshooting	8-1
Solving Problems	8-3
Accessory Problems	8-3
Audio Problems	8-4
Display Problems	8-4
Floppy Disk Drive Problems	8-5
Hard Disk Drive Problems	8-5
Keyboard, Mouse, and TouchPad Problems	8-6
Infrared Problems	8-7
Memory Problems	8-8
PC Card (PCMCIA) Problems	8-8
Performance Problems	8-9
Power and Battery Problems	8-10
Printing Problems	8-12
Serial and Parallel Problems	8-13
Startup Problems	8-14
9. Specifications and Regulatory Information	9-1
Hardware Specifications	9-3
Software System Resources	9-5
Safety Information	9-7
Regulatory Information	9-10
U.S.A.	9-10
Canada	9-11
Japan	9-11
Declaration of Conformity	9-12

Introducing the OmniBook

Introducing the OmniBook

Congratulations! Your OmniBook sets a new standard in personal computing. Although it's compact and easy to carry, the OmniBook is infused with the quality and attention to detail that are the hallmark of Hewlett-Packard.

The OmniBook *Quick Start* sheet shows how to get your OmniBook up and running quickly. This *Reference Guide* shows how to set up and operate the OmniBook and it also shows what to do if you run into trouble.

Other sources of supplementary information about OmniBook products include the following:

Source	Address or Number
Online <i>User's Handbook</i>	This introduces the OmniBook and shows you the OmniBook basics. It also contains troubleshooting information. Look in the OmniBook Library group.
Online <i>OmniBook Notes</i>	For late-breaking information available after the manuals were completed, see OmniBook Notes in the online OmniBook Library.
The Introducing Microsoft Windows 95 manual	This is shipped with your OmniBook and contains information about using the standard features of Windows 95.
HP website	http://www.hp.com/go/omnibook (http://www2.hp.com/go/omnibook , European mirror)
<i>Corporate Evaluator's Guide</i>	The provides information about installing alternate operating systems, as well as how to configure the OmniBook in a corporate, networked environment. Located at the HP external website.
HP Bulletin Board Service*	See the <i>Support and Service</i> booklet for telephone numbers.
HP First (automated fax)	See the <i>Support and Service</i> booklet for telephone numbers.
HP Support Assist CD-ROM	See the <i>Support and Service</i> booklet for telephone numbers.
* Baud rates = 300-28.8; Parity = N, Data bits = 8; Stop bits = 1.	

Taking Inventory

The HP OmniBook 3000 represents a new category of HP notebook computers featuring the latest mobile technologies available. It uses high-speed Intel Pentium processors with MMX technology, a large TFT displays, and high-capacity hard drives.

This chapter describes

- ◆ What's included in the OmniBook shipment.
- ◆ OmniBook configuration and model information.
- ◆ Available OmniBook accessories.
- ◆ Description of OmniBook features.

Included in the OmniBook 3000 box

- HP OmniBook 3000.
- AC adapter (HP F1377A) and power cord.
- Floppy disk drive cable (HP F1380A).
- Main battery (HP F1382A).
- This OmniBook *Reference Guide*.
- *Microsoft Windows 95* manual and Certificate of Authenticity.
- *Support and Service* booklet.
- Quick Start sheet.
- List of optional OmniBook accessories.
- OmniBook *Recovery CD*. Includes Windows 95 recovery, operating system drivers, and online *User's Handbook*.
- Windows 95 Companion CD.

Models and configurations

As of this printing, you can currently purchase two HP OmniBook 3000 models. The following tables describes the features of each.

HP OmniBook 3000CTX 5/200

HP OmniBook Model	Product Number	Pentium® Processor with MMX™ technology	Memory	Display	Hard Disk
CT	F 9 A	-MH	MB	TFT GA	billion bytes

HP OmniBook 3000CTX 5/233

HP OmniBook Model	Product Number	Pentium Processor with MMX technology	Memory	Display	Hard Disk
CT	F 9 A	-MH	MB	TFT GA	billion bytes

Optional OmniBook accessories

HP Part Number	Description
F1381A	Port replicator.
F1369A	Monitor stand.
F1387A	20X internal CD-ROM drive.
F1363A	16-MB RAM expansion module.
F1364A	32-MB RAM expansion module.
F1365A	64-MB RAM expansion module.
F1385A	2.1-billion-byte hard disk drive.
F1386A	4.0-billion-byte hard disk drive.
F1384A	3.5" internal/external floppy disk drive and cable.
F1388A	Internal Zip drive.
F1382A	Standard Lithium-Ion battery pack.
F1383A	Secondary Lithium-Ion battery pack.
F1377A	AC adapter.
F1379A	Automobile adapter.
F1380A	Replacement floppy disk drive cable.

Introducing the OmniBook
Taking Inventory

OmniBook features

The following three illustrations point out the main external features of the computer.

OmniBook—Front View

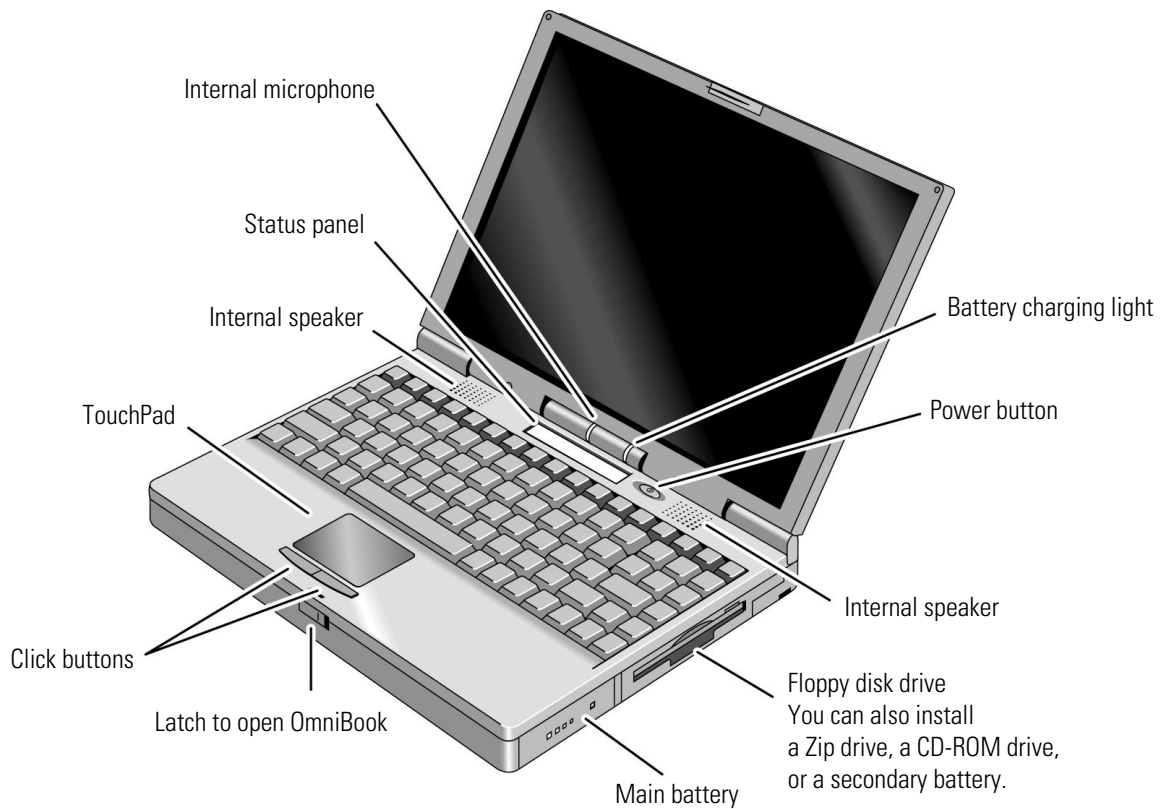

OmniBook—Side View

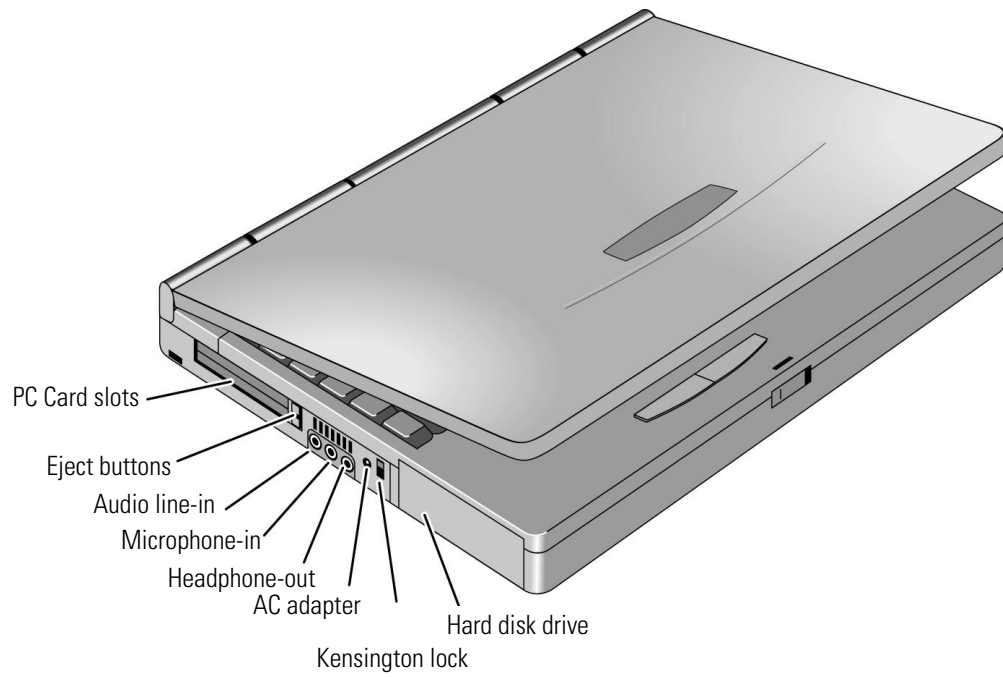

OmniBook—Back View

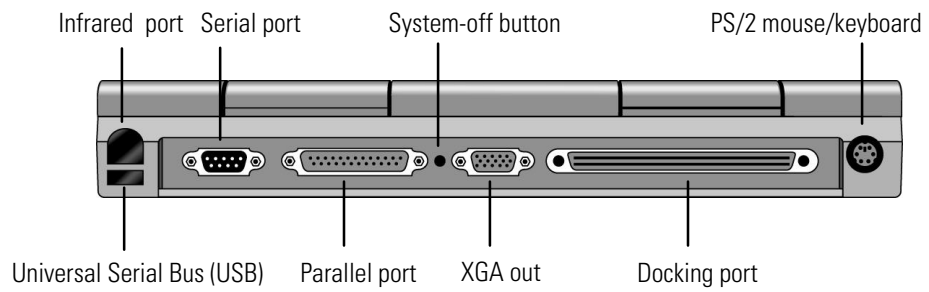

Setting Up the OmniBook

Setting Up The OmniBook

This chapter describes how to set up the OmniBook with the factory-installed Windows 95 operating system or how to add OmniBook-specific software and device drivers to your custom build.

This chapter includes

- ◆ Setting up Windows 95.
- ◆ Configuring the OmniBook using the BIOS Setup Utility.

Setting Up Windows 95

This section describes how to

- ◆ Connect ac power and charge the battery.
- ◆ Run the Windows 95 setup program.

To connect ac power

There are two ways to power the OmniBook: by battery and by ac adapter.

CAUTION

Use only the HP adapter model F1377A with this product,. Using any other ac adapter could damage the OmniBook and void your warranty.

1. Connect the power cord to the ac adapter, then plug the cord into an ac outlet. The indicator light on the ac adapter shines when the adapter is powered.
2. Connect the ac adapter to the OmniBook's left side, as shown.

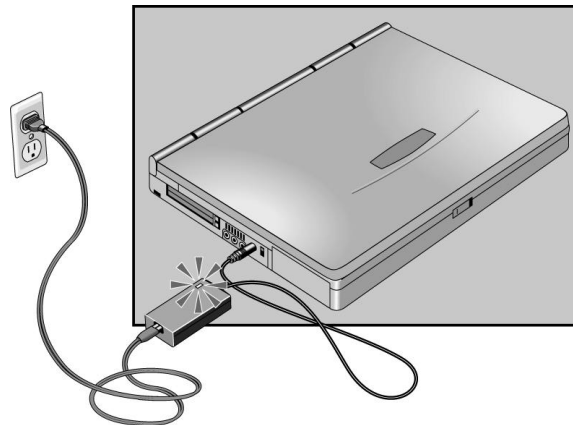

The HP F1379A automobile adapter is available to power the computer via a car's cigarette lighter.

To run the Windows 95 Setup utility

The OmniBook has Windows 95 factory-installed on the hard disk drive. When your OmniBook starts up the first time, it takes you through a series of setup screens, including installation of the operating system.

1. Plug in the ac adapter.
2. Press the blue power button.

The Windows 95 Setup program starts automatically.

3. After you accept the License Agreement and enter the Product ID (printed on the Certificate of Authenticity on the Microsoft *Introducing Windows 95* book), click OK to continue setting up Windows 95.

Configuring the OmniBook

The BIOS (Basic Input and Output System) Setup program is a menu-driven utility that enables you to make changes to the system configuration and tailor the operation of your OmniBook to your individual work needs.

The setting made in the BIOS Setup utility generally control the hardware and consequently have a fundamental affect on how the OmniBook operates.

This section describes the BIOS Setup Utility menus and options in detail.

To run the BIOS Setup Utility

1. Close all applications, then shut down Windows and reboot the OmniBook. If necessary, you can press CTRL+ALT+DEL to reboot.
2. During reboot, when you see “Press <F2> to enter Setup” at the bottom of the screen, press F2 to start the BIOS Setup Utility.
3. The TouchPad or mouse is not active in the BIOS Setup Utility. Press the RIGHT and LEFT arrow keys to move among menus. Press the DOWN and UP arrow keys to move among parameters in a menu. Press ENTER to change a setting. See the tables below for more information.
4. After you select the options you want, press F10 or use the Exit menu to exit the BIOS Setup Utility. If the settings cause a conflict between devices during reboot, the system prompts you to run BIOS Setup, and the conflicting settings are marked.

Main Menu		Default
System Time	Sets the time using 24-hour format.	
System Date	Sets the date using mm/dd/yy format.	
Floppy Drive	Sets the floppy drive type.	
Hard Disk	Sets the hard disk drive type and various parameters.	
Quiet Boot	When disabled, runs power-on self-test and shows summary during boot.	Disabled
Video Display Device	Sets whether the built-in and external display signals automatically switch when an external display is detected, or whether both signals are active. Pressing Fn+F5 temporarily switches between options.	Auto
System Memory	Shows the system memory size.	
Extended Memory	Shows the extended memory size.	

System Devices Menu

Default

Parameters marked with * below appear only if the main parameter is Enabled (values specified by settings below). The list of parameters scrolls if it is longer than the screen.		
PS/2 Mouse	Enables the PS/2 TouchPad and external PS/2 mouse, if present.	Enabled
External Fn Key	Sets whether left-CTRL + left-ALT on an external keyboard is interpreted as the Fn key.	Enabled
IDE Controller	Enables the primary (hard drive) and secondary (optional CD-ROM drive) controllers.	Both
FDD Controller	Enables the floppy drive.	Enabled
Serial Port	Sets how the serial port is configured: by the BIOS (specified or automatic) or by a PnP operating system.	Enabled
Base I/O address*	Sets the I/O address and interrupt.	3F8h, IRQ4
Infrared Port	Sets how the infrared port is configured: by the BIOS (specified or automatic) or by a PnP operating system.	Disabled
Mode*	Sets the hardware to support SIR (Standard IR), ASK IR, or FIR (Fast IR) infrared communications. (Driver installation required.)	SIR
Base I/O address*	Sets the I/O address and interrupt.	2F8h, IRQ3
DMA channel*	For Fast Ir mode, sets the DMA channel.	DMA3
Parallel Port	Sets how the parallel port is configured: by the BIOS (specified or automatic) or by a PnP operating system.	Enabled
Mode*	Sets the port to normal, bi-directional, EPP, or ECP.	ECP
Base I/O address*	Sets the I/O address.	378h
Interrupt*	Sets the interrupt.	IRQ7
DMA channel*	For ECP mode, sets the DMA channel.	DMA3

Setting Up the OmniBook
 Configuring the OmniBook

System Devices Menu (continued) Default

Audio	Sets how the audio system is configured: by the BIOS (specified or automatic) or by a PnP operating system.	Enabled
SB I/O address*	Sets the Sound Blaster I/O address.	220h
WSS I/O address*	Sets the Windows Sound System I/O address.	530h
AdLib I/O address*	Sets the AdLib synthesizer I/O address.	388h
Interrupt*	Sets the interrupt.	IRQ5
1st DMA channel*	Sets the DMA channel for playback.	DMA1
2nd DMA channel*	Sets the DMA channel for recording.	DMA0
MPU Device	Sets how the MIDI capability is configured: by the BIOS (specified or automatic) or by a PnP operating system. The port replicator provides a MIDI port, but not the OmniBook.	Disabled
MPU I/O address*	Sets the MIDI I/O address.	330h
Interrupt*	Sets the interrupt.	IRQ9

Security Menu Default

System Password is	Shows whether a password is set.	Clear
Set System Password	Press ENTER to set, change, or clear the password and save all Setup changes. (Up to 8 alphanumeric keys, prefix keys ignored.)	
Password on Boot	Sets whether the password is required to boot.	Disabled
Password on Resume*	Sets whether the password is required to continue after Suspend and Hibernate.	Disabled

Setting Up the OmniBook
Configuring the OmniBook

Power Menu

Default

Power Menu		Default
Power Management Mode	Disables time-outs, selects a combination of time-outs, or allows customized time-outs.	Max Power Savings
Smart CPU Mode	Enables automatic CPU power savings. Absence of keyboard, mouse, and hard disk activity could cause slower CPU response.	On
Standby Time-out	Sets the period of inactivity after which the computer goes from On to Standby power mode.	2min
Suspend Time-out	Sets the period of inactivity after which the computer goes from Standby to Suspend power mode. (Skips Standby mode if that time-out is disabled.)	4min
Hibernate after 4 hours	Sets whether the computer goes from Suspend to Hibernate power mode after the indicated period of inactivity. (Skips Suspend mode if that time-out is disabled.)	Enabled
Hard Disk Time-out	Sets the period of hard disk inactivity after which the hard disk stops spinning.	30sec
Time-out on AC	Sets whether power management time-outs occur while the ac adapter is connected.	Disabled
Power Button Mode	Sets the action of the blue power button when pressed for less than 4 seconds.	Suspend
Resume on Modem Ring	Sets whether the system resumes from Suspend if a ring signal is received.	Enabled
Resume on Time of Day	Sets whether the system resumes from Suspend at a defined time of day.	Disabled
Resume Time	Sets the 24-hour time when the system resumes from Suspend if enabled.	

Setting Up the OmniBook
Configuring the OmniBook

Boot Menu		Default
Diskette Drive Hard Drive CD-ROM Drive	Shows the order of boot devices. Move the entries to change the order.	1. Diskette drive 2. Hard drive 3. CD-ROM drive

Exit Menu

Save Changes and Exit	Saves Setup changes, exits, and reboots.	
Discard Changes and Exit	Discards Setup changes since last save, exits, and reboots.	
Get Default Values	Restores all default settings, and stays in Setup.	
Load Previous Values	Discards Setup changes since last save, and stays in Setup.	
Save Changes	Saves Setup changes, and stays in Setup.	



Getting Comfortable

Getting Comfortable

This chapter introduces the OmniBook and helps you get familiar with basic operation including how to

- ◆ Start and stop the OmniBook (including power modes).
- ◆ Use the OmniBook TouchPad.
- ◆ Adjust the OmniBook display.
- ◆ Use the OmniBook keyboard.
- ◆ Check the status of the OmniBook (status panel and battery lights).
- ◆ Protect the OmniBook.

Starting and Stopping the OmniBook

You can easily start and stop your OmniBook using the blue power button. However, at certain times, you may want to use other methods for starting and stopping your OmniBook—depending on power considerations, types of active connections, and start-up time.

To turn the OmniBook on and off

You can stop the OmniBook several ways. Some methods provide “Instant-On,” so you can quickly continue your work where you left off. Others reboot the computer.

On	Press the blue power button to turn on the OmniBook.
Standby	Press Fn+S to go into Standby mode. —or— Occurs automatically if the computer is inactive for about 2 minutes (by default).
Suspend	Press the blue power button to suspend activity when the OmniBook is on. The OmniBook restores your previous work session when you turn it back on. —or— From the Start menu, click Suspend —or— Press Fn+R —or— Close the lid (for more than 2 seconds) also suspends the computer. (If an external monitor is connected, closing the lid merely turns off the built-in display and turns on the external display.)
Hibernate	Press Fn+F12. The computer completely shuts down, but your current work session is first saved to disk. The computer will restore your previous session when you turn it back on.
Off	From the Start menu, click Shut Down, or press the blue power button for more than 4 seconds to completely shut down the computer. Unsaved data will be lost. The computer will reboot when you turn it back on.

To use OmniBook power modes

Hint Time-out settings . In order to save power, you can change time-outs to automatically enter different power states after a certain amount of inactivity.

When you	The OmniBook enters	To exit this mode
Press Fn+S or allow time-out.	Standby Mode Turns off the display only. Maintains network connections. Restarts quickly ("Instant-On").	Press any key. Any mouse or TouchPad movement will also exit Standby mode.
Press blue power button or close the lid or click Start, Suspend or allow time-out.	Suspend Mode Turns off the display. Saves significant power. Saves current session in RAM. Restarts quickly ("Instant-On"). Loses network connections. *	Press the power button to resume.
Press Fn+F12 or allow time-out.	Hibernate Mode Saves to disk, then reboots. Saves maximum power. Saves current session on Disk.	Press the power button to turn on and restore the current session.
Click Start, Shut Down (recommended) or Press blue power button longer than 4 seconds.	Off Mode Saves maximum power. Resets everything at startup. Starts a new session.	Press the power button to turn on and reboot.
* Windows 95 can restore network connections when you turn on the OmniBook. For a different operating system, you may have to reboot the OmniBook or restart the operating system to restore them.		

Note If the ac adapter is connected, the OmniBook battery continues to charge in any mode.

To reset the OmniBook

If Windows or the OmniBook stops responding, you can reset the OmniBook and restart Windows.

1. If possible, shut down Windows.
2. Press the blue power button for 4 seconds.

–or, if this fails–

Insert a pen or straightened paper clip into the recess on the back panel, as shown.

3. After the computer shuts down, press the blue power button to turn it on.

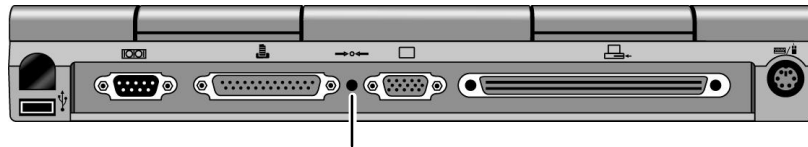

System-Off button. Insert a paper clip,
then press the blue power button to
reset the OmniBook.

Using the OmniBook TouchPad

The TouchPad is a touch-sensitive pointing device located in front of the keyboard. The two click buttons are located in front of the TouchPad.

The TouchPad controls the motion and speed of the pointer on the screen. The click buttons work like those on a standard mouse—what the buttons do depends on the software being used.

This section describes how to

- ◆ Control the pointer.
- ◆ Drag objects without using buttons.
- ◆ Scroll through a document without using scroll bars.
- ◆ Configure the TouchPad, learn more, and get help.

To control the pointer

The TouchPad controls the motion of the pointer on the screen by detecting pressure.

1. To move the cursor, move your finger or thumb across the TouchPad in the direction you want the pointer to move.
2. To select an item, click the left button.

-or-

Tap on the surface of the TouchPad. *To double-click, tap twice.*

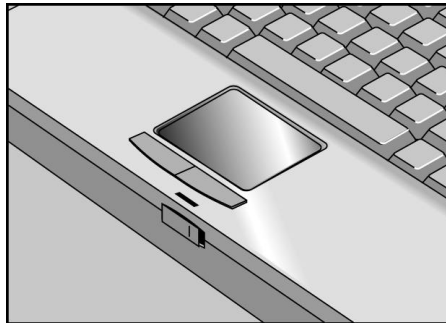

Hint

To customize the operation of the TouchPad, click Start, Settings, Control Panel, Mouse, TouchPad.

To drag objects

1. First move the pointer over the item.
2. Tap twice and leave your finger pressed on the TouchPad.
3. Use your finger on the TouchPad to move to the new location.

To scroll without scroll bars

You can scroll the display in a window without moving the pointer away from your work.

- Slide your finger up and down the right edge of the TouchPad.
When your finger reaches the top or bottom of the TouchPad, scrolling continues as long as you hold your finger against the edge.
The scrolling motion is touch-sensitive—the harder you press, the faster the scrolling.

To configure the TouchPad

The TouchPad has settings to adjust its sensitivity, speed, and how it interprets taps. There are also optional enhancements to choose from. There is online Help and a tutorial to explain the details.

1. Double-click My Computer, Control Panel, Mouse.
2. Click TouchPad, Enhancements.

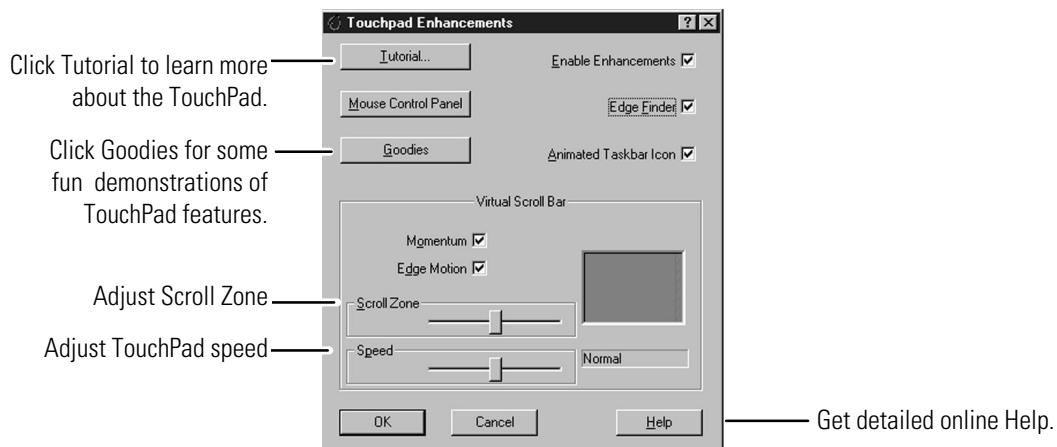

Using the OmniBook Display

The OmniBook display is a 13.3-inch XGA active-matrix (TFT) display (1024 × 768 × 64K colors). It supports PCI local bus video, 128-bit graphics controller with 2-MB video RAM, and Zoomed Video (enabled by default).

This section describes

- ◆ How to adjust the display brightness.
- ◆ The HP TFT quality statement.

To adjust the display

To maximize your battery operating time, set the brightness to the lowest comfortable setting, so that the internal light uses less power.

- Press Fn+F1 to decrease the brightness.
- Press Fn+F2 to increase the brightness.

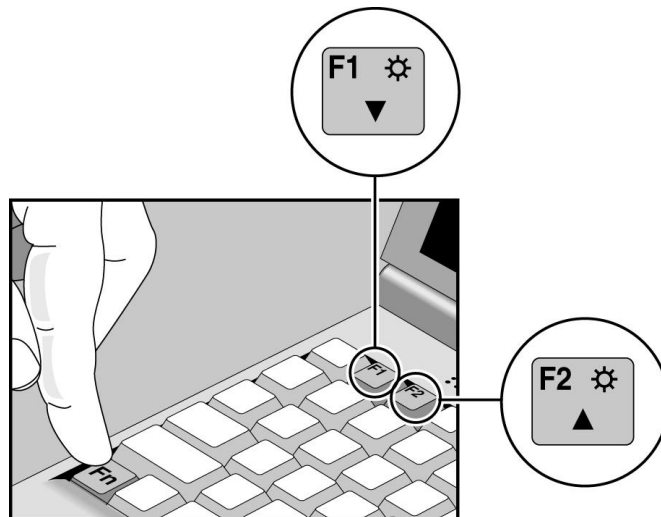

About TFT display quality

TFT display manufacturing is a high precision, but imperfect technology, and manufacturers cannot currently produce large displays that are cosmetically perfect. Most, if not all, TFT displays will exhibit some level of cosmetic imperfection. These cosmetic imperfections may be visible under varying display conditions and can appear as bright, dim, or dark spots. *This issue is common across all vendors supplying TFT displays in their products and is not specific to the HP OmniBook display.*

HP OmniBook TFT displays meet or exceed all TFT manufacturer's standards for cosmetic quality of TFT displays. HP does not warrant that the displays will be free of cosmetic imperfections. *TFT displays may have a small number of cosmetic imperfections and still conform to the display manufacturer's cosmetic quality specifications.*

Using the OmniBook Keyboard

W A R N I N G

Improper use of keyboards and other input devices has been associated with ergonomic injury. For information about reducing your risk, see the “Working in Comfort” instructions provided in the online OmniBook Library and in Windows Help. They are also available at our website, <http://www.hp.com/mcd/ergo>.

This section describes the special features of the OmniBook keyboard including

- ◆ Fn hot keys.
- ◆ Windows 95 keys.
- ◆ Embedded keypad.

To use the Fn hot keys

Labeled F1 through F12, these keys provide shortcut key sequences for various system controls. The OmniBook keyboard shows the Fn *hot keys* labeled in gray.

The following table provides a list and description of the OmniBook Fn key combinations.

Pressing these keys	Does this
Fn + F1	Decreases the display's brightness.
Fn + F2	Increases the display's brightness.
Fn + F3	Decreases the display's contrast (non-TFT displays only).
Fn + F4	Increases the display's contrast (non-TFT displays only).
Fn + F5	Switches among the built-in display, an external display, and simultaneous displays.
Fn + F6	For use with two batteries: Briefly displays the individual battery status for each battery, then resumes displaying the combined battery status. For complete information about battery status, see page 3-14.
Fn + F7	Toggles the sound on and off (mutes sound).
Fn + F8	Toggles the built-in keypad on and off. Does not affect an external keyboard. If Num Lock is on, then the numeric functions are active; otherwise, cursor control is active.
Fn + F9	Toggles Num Lock on and off for both built-in and external keyboards. For the built-in keyboard, keypad (Fn+F8) must also be on to get Num Lock.
Fn + F10	Toggles Scroll Lock on and off.
Fn + F12	Enters Hibernate mode.
Fn + S	Enters Standby mode.
Fn + R	Enters Suspend mode
Fn + UP-ARROW	Increases volume.
Fn + DOWN-ARROW	Decreases volume.

To use the Windows 95 keys

- The left and right Windows Logo keys bring up the Start menu.
- The function of the Windows Application key is application-dependent.

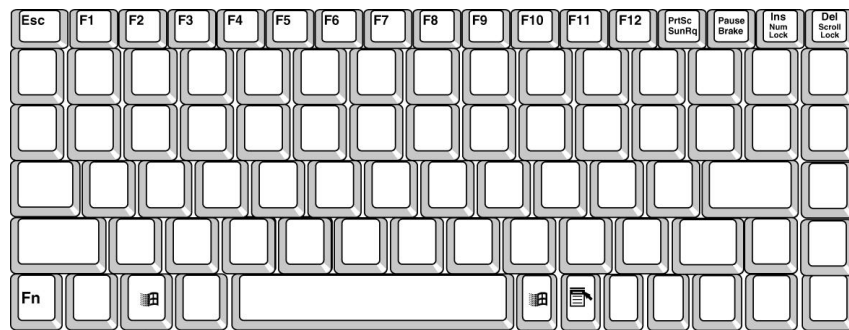

Windows 95 keys

To use the embedded keypad

When the keypad is active and Num Lock is on, keys change to the numeric or arithmetic designations printed in gray on the front faces of those keys.

1. Press Fn+F9 to turn Num Lock on and off.
2. Press Fn+F8 to turn the embedded keypad on and off.

-or-

To temporarily turn on the embedded keypad, hold Fn while typing a key.

Hint

Num Lock. Consider leaving Num Lock on all the time. Then, when you want to use the embedded keypad on your built-in keyboard, turn it on (by pressing Fn+F8) or by holding Fn for each keypad key.

Eternal Keyboard

- Press Fn+F9 to turn Num Lock on and off. This activates the numeric keys on an external keyboard.



Checking the Status of the OmniBook

The OmniBook status panel, located above the keyboard, contains indicators that show the current status of the OmniBook. The indicators in the status panel show keyboard status, drive status, and power status.











This section describes how to

- ◆ Read the status panel indicators.
- ◆ Interpret power and battery lights.

To read the status panel indicators

Indicator	Meaning
	AC power. The ac adapter is plugged in. <i>Blinks</i> when the battery is being charged.
	Battery status. Shows the approximate charge level of the battery relative to a full charge. Each bar (displayed from right to left), represents a 10% charge. The upper and lower triangles indicate the presence of main (upper) and secondary (lower) batteries. A triangle blinks when that battery is charging or is in use. The main battery charges first, discharges last. If two batteries are installed and ac power is not connected , the gauge reports the percent of total charge, where both batteries are included. For example, if the main battery is 50% and the secondary battery is empty then the gauge would read 25%. If two batteries are installed and ac power is connected , the gauge reports the percent of total charge for only the battery that is charging. For example, if the main battery is 50% and the secondary battery is empty, the gauge will read 50% indicating the state of the main battery. You can press Fn + F6 at any time to see the status of each individual battery.

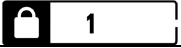
Getting Comfortable
Checking the Status of the OmniBook

Indicator	Meaning
	Battery low. The outline blinks when the battery charge is critically low. The OmniBook also beeps.
	Defective battery. An empty battery icon with ac plug not blinking. No battery activity; no charging.
	Overheated battery. The battery is too hot to charge.
	CD-ROM drive, hard disk drive, or Zip drive. The OmniBook is accessing one of these built-in drives.
	Floppy disk drive. The OmniBook is accessing the floppy disk drive.
	PC Card. There is activity between the PC Card and the computer.
	Suspend mode. These symbols flash from left to right when the OmniBook is suspended (turned off by pressing the power button briefly). If ac power is not connected, the green power light also blinks slowly.
	Caps Lock. Caps Lock is active.
	Num Lock. Num Lock is active (Fn+F9).
	Keypad Lock. The built-in embedded keypad is active (Fn+F8). Num Lock must also be on for the numeric keys. Otherwise, cursor keys are active.
	Scroll Lock. Scroll Lock is active (Fn+F10).

To understand power and battery lights

Power Lights

The green power light indicates the power state.

Power Light (on hinge)	Meaning
Steady green light	Battery charging.
Blinking light	Not charging (if ac power on). —or— OmniBook in Suspend mode (if ac power off).
No light	Not charging (ac power off).

Battery Lights

The battery itself has four square lights that indicate charge status when you press the square black button on the battery. Each light represents 25% charge.

The green lights on the main battery or secondary battery indicate its charge level.

Protecting the OmniBook

Your OmniBook provides several ways for you to identify and protect your computer. This section describes how to

- Set up password protection.
- Clear a password.
- Attach a security cable.
- Protect the hard disk drive.

To set a password

If password protection is set, then you will be prompted to enter a password whenever you reset or turn on the computer (depending on your setting). You cannot use the computer until you enter the correct password.

To set or change password protection, use the BIOS Setup Utility.

1. Reset the computer and press F2, when prompted, to enter the BIOS Setup Utility. Active keys are described along the bottom of the screen. (The TouchPad does not work in BIOS Setup.)
2. Select the Security menu.
3. Select Set System Password, then press ENTER.
4. Type the new password, then press ENTER. *The password can contain up to eight alphanumeric characters, and it is not case-sensitive.*
5. Type the password again to confirm.
6. Choose when the password will be required: select Password on Boot and, if desired, Password on Resume. Press F5 to select Enabled or Disabled for each one.
7. Press F10 to save and exit BIOS Setup.

Note

If a password is set, but Password On Boot is not selected, then the password is still required to get into the BIOS Setup Utility.

Getting Comfortable
Protecting the OmniBook

Important

Be sure you record your password in a safe place. If you forget your password, you might need to return your OmniBook PC to Hewlett-Packard for repair. You will also need your proof-of-purchase. Call Hewlett-Packard at the number in the *Support and Service* booklet.

To delete a password

1. Reset the computer and press F2, when prompted, to enter the BIOS Setup Utility. Active keys are described along the bottom of the screen. (The TouchPad does not work in BIOS Setup.)
2. Select the Security menu.
3. Select Set System Password, then press ENTER.
4. Type the current password, then press ENTER.
5. Press ENTER at the Enter New Password prompt.
6. Press ENTER at the Confirm New Password prompt.
7. Press Continue to save changes.

To attach a security cable

Your OmniBook has a built-in connector that allows you to secure the OmniBook with a cable. The Kensington MicroSaver lock system works with these connectors and is available at many computer stores. The same lock works with an OmniBook port replicator.

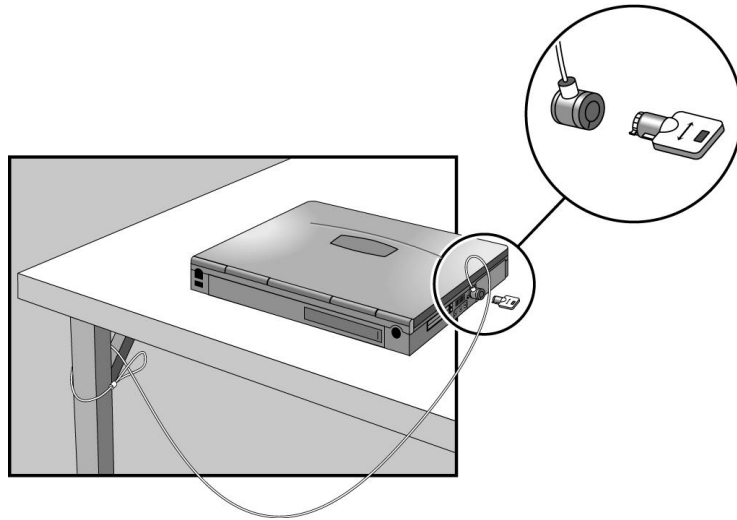

Protecting the Hard Disk Drive and Memory

When you have a Kensington MicroSaver lock system connected to the OmniBook, the lock blocks removal of the hard disk drive and memory modules from the OmniBook.

Power Management

Power Management

The OmniBook conserves power by using Advanced Power Management (APM), software that controls battery charging and power drain.

The OmniBook provides several safeguards so you won't be surprised by a dead-battery condition, including the following:

- ◆ The battery status indicator shows the remaining battery charge.
- ◆ Built-in warnings are displayed for low-battery conditions.
- ◆ The OmniBook automatically turns off when the battery charge gets too low—your session continues when you start recharging the battery or insert a fresh battery.
- ◆ Data on any of the drives is not affected by a low battery—unless the battery runs down completely while writing data to the drive, or if the battery in a PC RAM card is also low.

Monitoring Battery Power

The primary source of power for the OmniBook is its rechargeable battery pack. You can use the ac adapter to recharge the battery—or to run on ac power to preserve the battery.

Important

Running external connections is a power-intensive operation that significantly shortens the length of a battery session. Whenever possible, connect the ac adapter when using external connections.





This section describes how to

- ◆ Check the battery status.
- ◆ Update the battery status indicator.
- ◆ Respond to a low-battery warning.
- ◆ Recharge a battery.
- ◆ Replace the main battery.
- ◆ Install a secondary battery.

To check the battery status

From the Status Panel

The following table explains how to check battery status from the OmniBook status panel.

 Full battery	<p>Shows the approximate charge level of the battery relative to a full charge. Each bar (displayed from right to left), represents a 10% charge.</p> <p>The upper and lower triangles indicate the presence of main (upper) and secondary (lower) batteries. A triangle blinks when that battery is in use. The main battery charges first, discharges last.</p> <p>See "Battery Status" on page 3-14 for more information about the battery indicators.</p>
 Low battery	<p>The outline blinks when the battery charge is critically low. The OmniBook also beeps.</p>
 Defective battery	<p>No battery activity; no charging. If a left bar appears in the far left of the battery cell, the battery is overheated, so charging stops.</p>
 AC power connected	<p>AC power is connected. If the indicator is blinking, then the battery is also being charged.</p>

From the Windows Taskbar

- Place the pointer over the battery indicator at the right end of the taskbar. The approximate battery charge is displayed in a pop-up window.



For additional power information, click My Computer, Control Panel, Power.

To respond to a low-battery warning

When battery power is critically low, the battery indicator in the status panel appears empty and starts to blink. A warning beep reminds you to save your work. (Press Fn+F7 to stop the beeping.)

The OmniBook automatically hibernates to preserve your current session. You won't be able to restart until you restore power by one of the following actions:

- Plug in the ac adapter.
–or–
- Replace the main battery with one that's charged.
–or–
- Install a charged secondary battery.

To recharge a battery

Charging the battery takes about 1.5 hours when the computer is off or suspended, or about 2.2 hours when the computer is in use.

CAUTION

The ac adapter is normally warm to the touch whenever it's plugged into an ac outlet. The OmniBook is normally warm while it's charging. Don't charge it in a briefcase or other confined space as this may cause the battery to overheat.

1. Connect the power cord to the ac adapter, then plug the cord into an ac outlet. The indicator light on the ac adapter shines when the adapter is on.
If the ac adapter does not light, make sure that cord is not damaged. Also ensure that the battery has been inserted correctly into the OmniBook.
2. Connect the ac adapter to the OmniBook's left side, as shown in the following illustration.

Power Management
Monitoring Battery Power

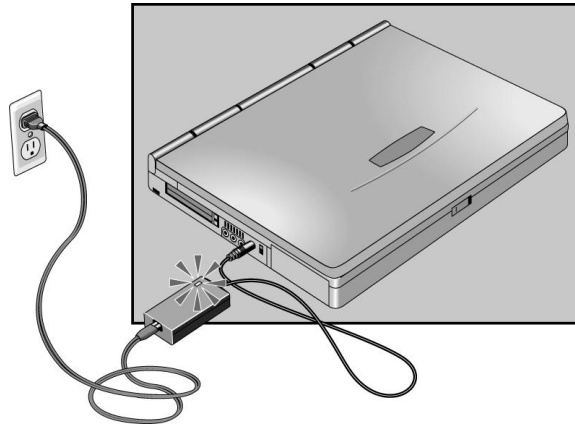

Optimum Charging

To get the longest battery operating time, continue charging until the ac power indicator stops blinking in the status panel. Charging stops when the battery is fully charged. Because of rounding, a battery indicator can show a full battery before it's fully charged. The ac power indicator stops blinking only when the battery is actually full. You can continue working while the battery is charging.

To replace the main battery

The main battery is located under the right corner of the palm rest.

WARNING

Do not mutilate, puncture, or dispose of batteries in fire. A battery can burst or explode, releasing hazardous chemicals. A rechargeable battery must be recycled or disposed of properly.

CAUTION

If you have any unsaved data, it (and your current work session) will be lost when you remove the battery *unless the computer is connected to ac power or a secondary battery is installed*.

1. Save your work.
2. From the Start menu, shut down the OmniBook.
3. Slide the safety latch for the battery compartment into its recess.
4. Slide *and hold* the release latch, then slide out the battery.
5. After inserting the new battery, close the safety latch.

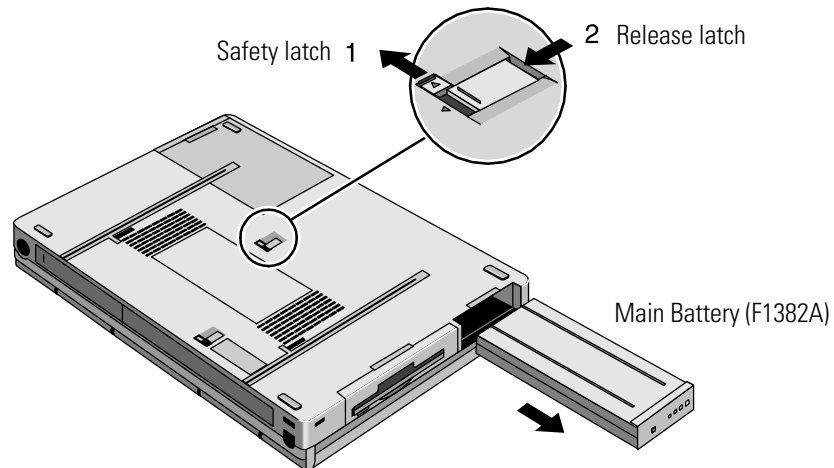

To install a secondary battery

The OmniBook is shipped with a floppy drive module installed in the plug-in slot. Other plug-in accessories are available, including a CD-ROM drive and secondary battery. See page 5-4 for more information about plug-in modules.

1. Slide the safety latch for the plug-in slot into its recess.
2. Slide and hold the release latch, then slide out the module.

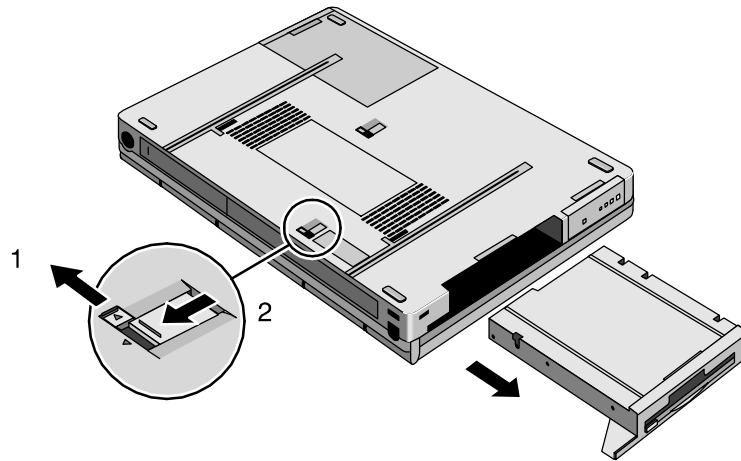

3. Slide the secondary battery module into the plug-in slot.
4. Close the safety latch.

A lower triangle appears next to the battery icon in the status panel.

Conserving Battery Power

The OmniBook uses Advanced Power Management (APM) to conserve battery power. You can take steps to optimize your battery operating time.

This section describes how to

- ◆ Save battery power.
- ◆ Specify the automatic time-out settings.
- ◆ Handle and store the battery safely.
- ◆ Maintain and preserve battery life.

To save battery power

Follow these suggestions to conserve battery power.

- Plug in the ac adapter, especially while using the floppy disk drive, the CD-ROM drive, or any external connections.
- Put the OmniBook in Suspend mode whenever you are not using it for a short while: close the lid, *or* press the blue power button for approximately 1 second, *or* select Start menu, Suspend.
- Put the OmniBook in Hibernate mode whenever you want to save your current session, but will not be using the computer for several hours or more (Fn+F12).
- Turn the OmniBook off whenever you will not be using it for several hours or more: press the blue power button for more than 4 seconds *or* select Start menu, Shut Down. The current session is *not* saved.
- Turn the brightness of the display down to the lowest comfortable level. This reduces the backlight power, *which can increase the battery operating time by as much as 15%*.
- Set the automatic time-out settings to emphasize saving power. (See the following topic.)
- If you work with an application that uses the serial port or a PC Card, exit the application when you are done using it.
- If you have an I/O PC Card—that is, a PC Card having an external connection, such as a modem or network card—remove it when you are not using it. Some I/O cards use significant power, even while they're inactive.

To set time-outs

The BIOS Utility program includes settings for automatic time-outs at specified periods of inactivity. There are four different time-outs for different levels of power and conservation.

1. Reboot the OmniBook and when prompted, press F2 to enter the BIOS Setup Utility. Active keys are described along the bottom of the screen. (The TouchPad does not work in Setup.) Help information for the highlighted item appears in the right-hand sidebar in the display.
2. Select the Power menu.
3. Select Power Management Mode. (Press the spacebar, F5, or F6 to pick an option *other than* Disabled.)

Maximum Power Savings : The time-out settings are defined for best power savings (relatively short time-outs).

Maximum Performance : The time-out settings are set for fast performance with some power conservation (relatively long time-outs).

Customized : You determine each setting for Smart CPU Mode, Standby Time-out, Suspend Time-out, Hibernate Time-out, and Hard Disk Time-out. For definitions of these power modes, see page 3-4.

4. Choose a setting for Time-Out On AC. If you want the time-outs to occur even when the OmniBook is connected to ac power, choose Enabled. To prevent time-outs while the OmniBook is plugged in, choose Disabled (default setting).
5. Press F10, then press ENTER to save your settings.

To handle and store the battery safely

- To avoid risk of fire, burns, or damage to your battery pack, do not allow a metal object to touch the battery contacts.
- The battery pack is suitable for use only with compatible OmniBook models. Check the *Support and Service* booklet for your local HP contact.
- Do not disassemble. There are no serviceable parts inside. Do not dispose of the battery pack in fire or water.
- Handle a damaged or leaking lithium-ion battery with extreme care. If you come in contact with the electrolyte, wash the exposed area with soap and water. If it contacts the eye, flush the eye with water for 15 minutes and seek medical attention.
- Do not expose the battery pack to high storage temperatures (above 60 °C, 140 °F).
- When the battery is not in use, store it in the battery pouch provided.
- When discarding a battery pack, contact your local waste disposal provider regarding local restrictions on the disposal or recycling of batteries.
- To obtain a replacement battery, contact your local dealer or HP sales office.
- Do not charge the battery pack if the ambient temperature exceeds 45 °C (113 °F).

To maintain and preserve battery life

To preserve the life of your battery, be sure to charge the battery regularly. In cases of long-term storage, the battery must be charged at 20-50% to save capacity loss by self-discharge and to avoid deterioration of battery performance.

In a discharged condition, the battery voltage decreases faster. Storage in a 100% charged condition can cause higher self-discharge and deterioration of discharge capacity—even after recharging compared to storage in a 20-50% charged condition

———— Making Connections

Making Connections

This chapter describes procedures to expand the capabilities of your OmniBook, including how to

- ◆ Use OmniBook plug-in accessory modules (illustrated below).
- ◆ Connect external devices.

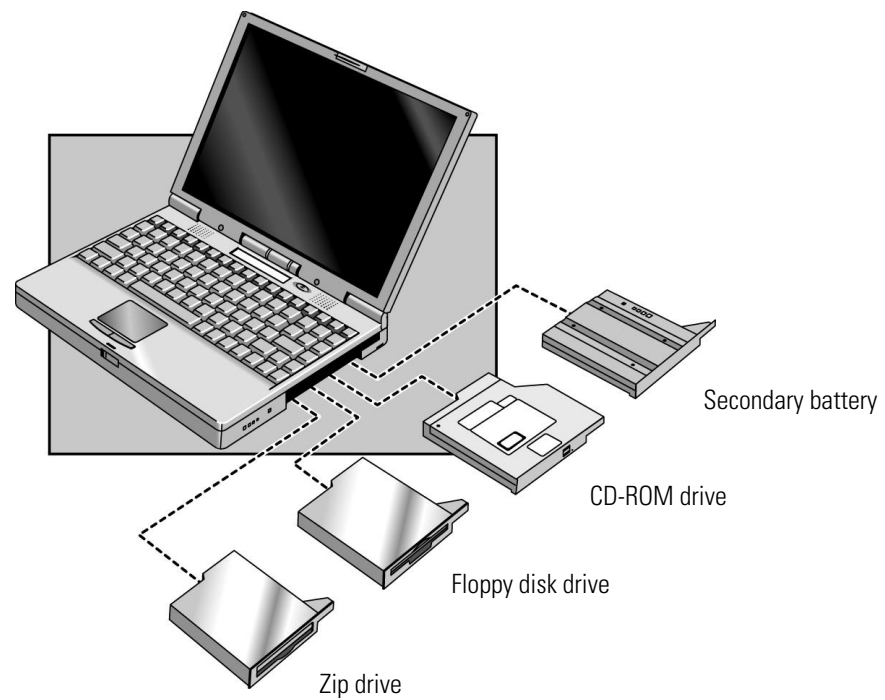

Using OmniBook Plug-In Modules

The plug-in module bay can hold an internal CD-ROM drive, a floppy disk drive, a Zip drive, or a secondary battery. This section describes how to

- ◆ Replace a plug-in module in the OmniBook.
- ◆ Install the floppy disk drive externally.
- ◆ Insert and eject a floppy disk.
- ◆ Insert and remove a CD.
- ◆ Use the CD-ROM safely.
- ◆ Open the CD-ROM drive manually.
- ◆ Install drivers for the Zip drive.
- ◆ Insert and eject a Zip disk.
- ◆ Eject a Zip disk manually.

To replace a plug-in accessory module

1. Important : If you are removing or inserting a CD-ROM drive or Zip drive, shut down the OmniBook before removing or inserting the plug-in module.(From the Start menu, shut down Windows 95.) This is not necessary if you are removing and installing the floppy disk drive or secondary battery.
2. Slide the safety latch for the plug-in slot into its recess.
3. Slide *and hold* the release latch, then pull out the module, as shown.

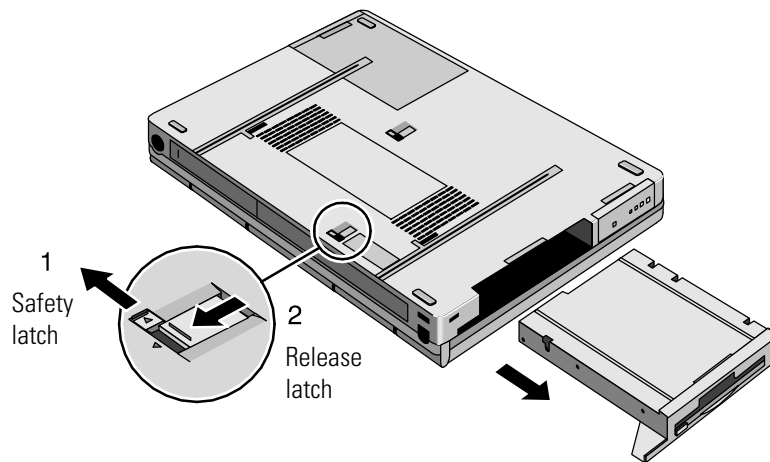

4. Insert the new plug-in module.
5. Close the safety latch.

CAUTION

If inserting another plug-in module, be sure the safety latch is open. Otherwise you could damage the module or your OmniBook.

To install the floppy disk drive externally

When using the plug-in floppy disk drive externally, the plug-in module bay can be used by another plug-in module—such as a CD-ROM drive, a Zip drive, or a secondary battery.

Only one floppy disk drive is supported on the OmniBook. *You cannot use both an external floppy disk drive and a plug-in floppy disk drive.*

- Connect the external floppy-drive cable to the OmniBook parallel port.

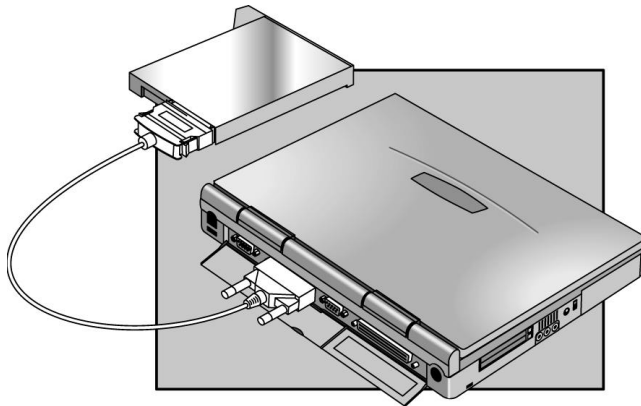

To insert and eject a floppy disk

CAUTION

Do not insert or remove a floppy disk while the OmniBook is actively reading or writing data. Otherwise, you could lose data or the OmniBook could stop responding.

1. Hold the disk with its face up, then slide it into the floppy disk drive slot until it clicks into place.
2. To remove the floppy disk, press the eject button on the front of the drive.

To insert or remove a CD

CAUTION

Do not insert or remove a CD while the OmniBook is actively reading data. Otherwise, the OmniBook could stop responding and you could lose data.

1. Press the button on the face of the CD-ROM drive.
2. Place the CD into the drive and gently press down to seat the CD on the spindle.
-or-
Remove the CD.
3. Close the door to the drive.

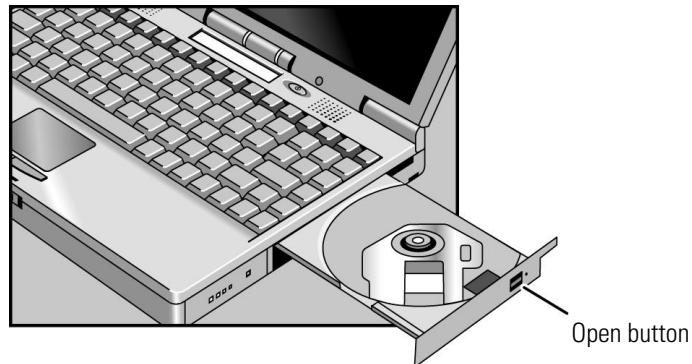

To use the CD-ROM drive safely

- If the unit requires service, contact an authorized HP service center—see the *OmniBook Support and Service* booklet.
- Do not attempt to make any adjustment of the unit.
- Avoid direct exposure to the laser beam.

To open the CD-ROM drive manually

If you lose power to the OmniBook, or if you have removed the CD-ROM module from the OmniBook, you can manually open the CD-ROM drive to remove a CD.

- Insert a straightened paper clip into the recessed hole, as shown.

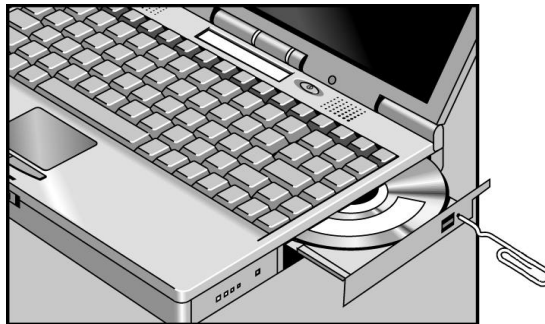

To install drivers for the Zip drive

The Zip drive comes with a CD containing drivers and software for the Zip drive. Follow these steps to set up this software.

1. Set up a CD-ROM drive for your OmniBook. (The Zip drive does not have to be installed at this time.)
2. Insert the Zip CD in the CD-ROM drive.
3. Click Start, Run, then type *drive*:\install and click OK, where *drive* is the drive letter of the CD-ROM drive. For example, type d:\install if the CD-ROM is drive D. This installs the Zip software so it's ready whenever you insert the Zip drive.

To obtain the latest versions of Zip drivers and software, access the Iomega website at <http://www.iomega.com/>.

To insert and eject a Zip disk

CAUTION

Always turn on power to the OmniBook before inserting a Zip disk. When you insert a Zip disk, the green busy light will flash momentarily and go out. (If the light continues to blink slowly, push the disk eject button to eject the Zip disk, then insert it again.) Do not insert or remove a Zip disk while the OmniBook is actively reading data. Otherwise, the OmniBook could stop responding and you could lose data.

- To insert the Zip disk, hold the disk with its face up and then gently insert it into the Zip drive.
- To remove the Zip disk, gently press the eject button on the front of the Zip disk drive. Do not use force. The green busy light blinks as the disk spins down. The drive takes a few seconds to eject the disk.

The Zip drive automatically ejects the disk when you shut down your OmniBook. Store all your Zip disks in the protective case when not in use.

To eject a Zip disk manually

The OmniBook must be on for normal disk ejection from the Zip drive. If you need to remove a Zip disk from the drive when power is off, carefully push a straightened paper clip into the emergency eject hole located on the eject button.

CAUTION

Use the manual disk eject procedure only when OmniBook power is off. Do not try to forcibly remove a Zip disk from the drive. If the disk does not eject immediately, repeat the manual disk eject procedure.

Connecting External Devices

Your OmniBook is a powerful computer in its own right—but you can greatly expand its capabilities by connecting other devices.

Note

Before you connect any device, check the documentation that came with the equipment to see if you need to make any settings or adjustments to the equipment before using it. This might include setting switches to configure the equipment so that it will operate properly with the OmniBook and the software you plan to use.

This section describes how to

- ◆ Connect an external monitor.
- ◆ Enable the built-in and external displays.
- ◆ Connect a parallel device.
- ◆ Connect a serial device.
- ◆ Connect an external PS/2 keyboard or PS/2 mouse.
- ◆ Connect a Universal Serial Bus (USB) devices.
- ◆ Insert and eject PC Cards.
- ◆ Review a list of tested PC Cards.
- ◆ Connect audio devices.
- ◆ Dock and undock the OmniBook to a port replicator.
- ◆ Make an infrared connection.

To change display settings in the BIOS Setup Utility

1. Close all applications, then shut down Windows and reboot the OmniBook.
2. When you see the following message, press F2 to enter the BIOS Setup Utility.
Press <F2> to enter SETUP
3. From the Main menu, use the down arrow to highlight Video Display Device.
4. Press ENTER to view choices.
5. Select External, Internal, or Both.
6. Press F10 to save settings and exit Setup.

To connect a parallel device

The parallel port uses a standard 25-pin connector, most commonly used for connecting a printers. These include dot matrix, ink-jet, and laser printers. The parallel port supports both EPP and ECP capabilities (if selected in BIOS Setup).

- Connect the parallel printer cable or other parallel cable to the parallel port.

The OmniBook has one parallel port. Its address and properties can be set in the BIOS Setup Utility.

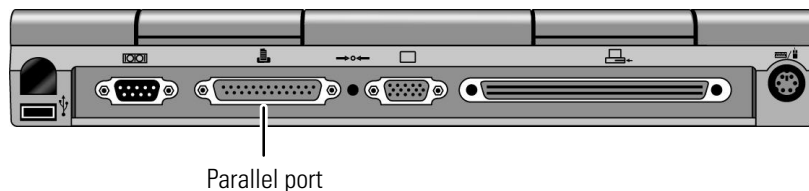

To connect a serial device

The OmniBook's serial port uses a standard 9-pin serial port. Serial connections typically are to external modems and fax modems. You can make such connections using standard serial cables and adapters available at computer dealers and electronic supply stores.

- Connect the serial cable to the serial port.

For a serial mouse, you need to select Standard Serial Mouse in Control Panel, Mouse, General, Change.

The OmniBook has one serial port. Its address can be set in the BIOS Setup Utility.

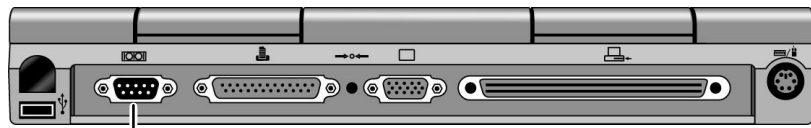

Serial port

To connect an external keyboard or PS/2 mouse

The 6-pin PS/2 port allows you to attach an external keyboard or a PS/2-compatible mouse to the OmniBook.

1. Press the power button for one second to suspend the OmniBook.
2. Plug the mouse or keyboard PS/2 cable into the PS/2 port on the OmniBook.

If the device has a PC-type jack, first connect its cable to an adapter cable with a PS/2 jack.

3. Press the power button to turn on the OmniBook.

PS/2 mouse
or keyboard

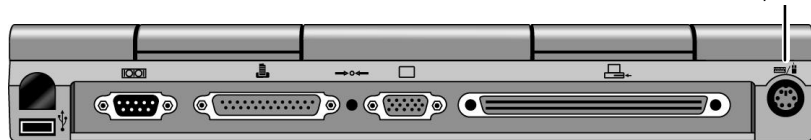

To connect Universal Serial Bus devices

Universal Serial Bus (USB) provides a bi-directional serial interface for adding peripheral devices such as game controllers, serial and parallel ports, and scanners on a single bus. The OmniBook provides one USB port; the OmniBook's port replicator provides two USB ports.

- Attach the USB cable to the USB port. Windows 95 automatically recognizes the USB device. Some USB devices can be connected to the OmniBook in series with other USB devices—this is called a “daisy-chain” connection.

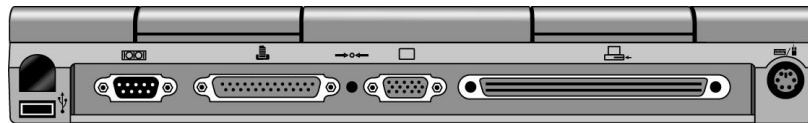

USB port

Note

If you have problems making this connection, contact the vendor of the peripheral device, as well as Hewlett-Packard, for the latest versions of the USB drivers. The USB technology is dynamic and continues to develop.

To insert a PC Card

The OmniBook PC Card slots are available for storing data and expanding the communication capabilities of the OmniBook. The OmniBook supports standard Type I, II, and III PC Cards (PCMCIA and CardBus). You can use two type I or II cards or one type III card. The lower card slot (slot zero) supports Zoomed Video, which allows high-quality multimedia presentations.

1. Hold the card with its face up and its connector holes toward the card slot.
2. Slide the PC Card into the slot until it is flush with the OmniBook.

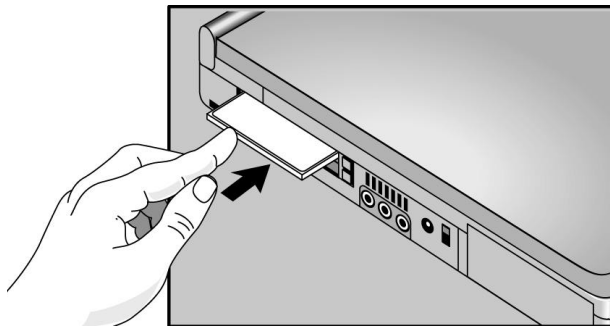

A double beep signals that the PC Card is recognized and successfully configured.

To remove a PC Card



PC Card indicator

Do not insert or remove a PC Card while the OmniBook is actively reading or writing data. Otherwise, you could lose data or the OmniBook could stop responding. When the card is active, the PC Card indicator appears on the status panel.

1. Click the PC Card indicator in the taskbar, then click Stop.

This protects your data and avoids unexpected problems. You can restart the card by removing it, then inserting again.

2. Press the ejector button once to pop the button out.
3. Press the eject button again to eject the PC Card.

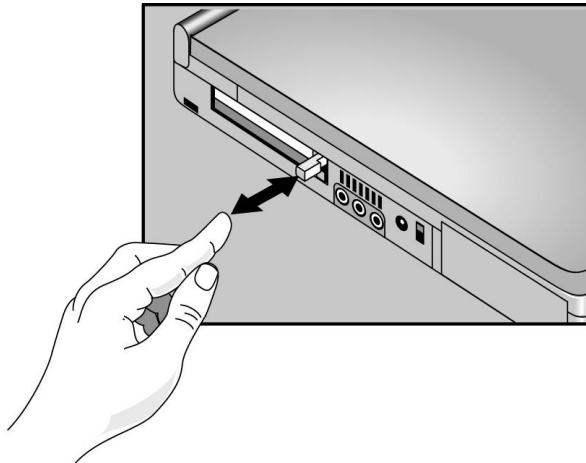

List of tested PC Cards

At the time of this printing, the following cards have been tested for use with the OmniBook.

For the latest information about compatible cards, visit our website at <http://www.hp.com/go/omnibook> and check the Approved Solutions. Or contact Hewlett-Packard as described in the *Support and Service* booklet.

Manufacturer	Card Description	Operating System Tested
Ositech	Combination Ethernet Lan + 33.6 Modem	Windows 95 Windows NT 4.0
Ositech	Seven of Diamonds 10/100 Ethernet Adapter	Windows 95 Windows NT 4.0
Xircom	Combination Ethernet Lan + 56K Modem	Windows 95 Windows NT 4.0
Xircom	CardBus 10/100 Ethernet Lan Adapter	Windows 95 Windows NT 4.0
Olicom	Go Card Token Ring Adapter C30 OC3221	Windows 95 Windows NT 4.0
Olicom	Combination Token Ring + 33.6 Modem	Windows 95 Windows NT 4.0

To connect audio devices

There is a built-in microphone located just below the OmniBook display. You can use it to record voice, sound, and music. You can also plug in a stereo input source, (such as a CD player), an external microphone, external speakers or headphones.

WARNING

The audio jacks are three-terminal stereo jacks. They are not compatible with two-terminal mono plugs. Connecting a mono plug into the speaker-out jack may damage the OmniBook.

- Attach the audio cable to the corresponding audio port.

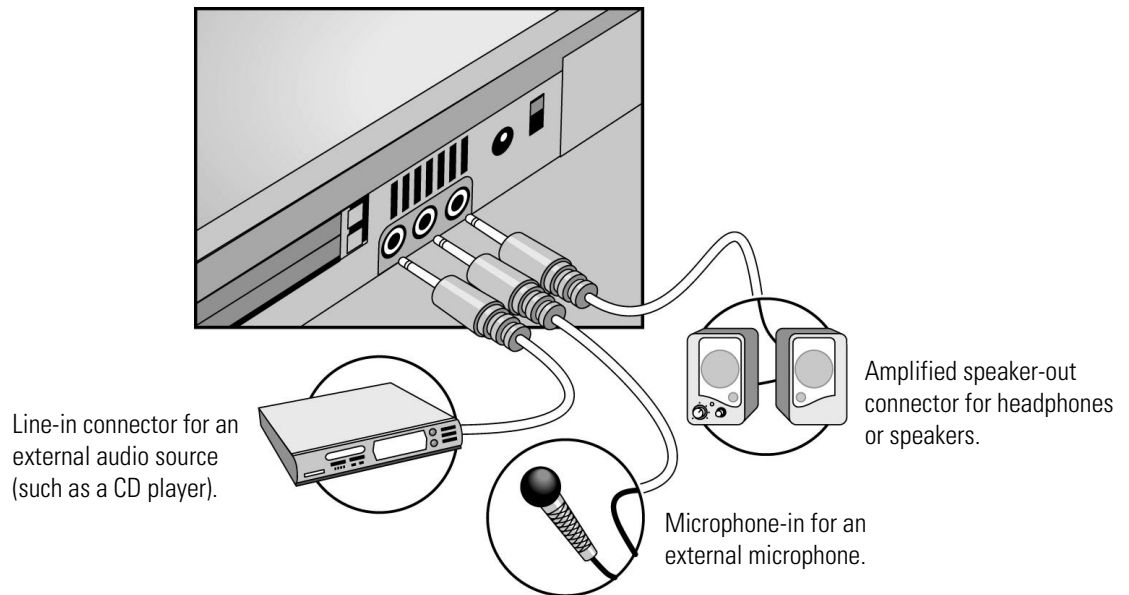

Note

- When you plug a device into the microphone-in port, the built-in microphone automatically turns off.
 - When you plug a device into the speaker-out port, the built-in speakers automatically turn off.
-

To dock the OmniBook

CAUTION

Use only an HP F1377A ac adapter (the type shipped with the OmniBook) —do not use an ac adapter from another product. Using an improper adapter could damage the OmniBook and will make your warranty invalid.

1. Plug the power cord into the ac adapter, then into an ac outlet. Plug the ac adapter into the port replicator.

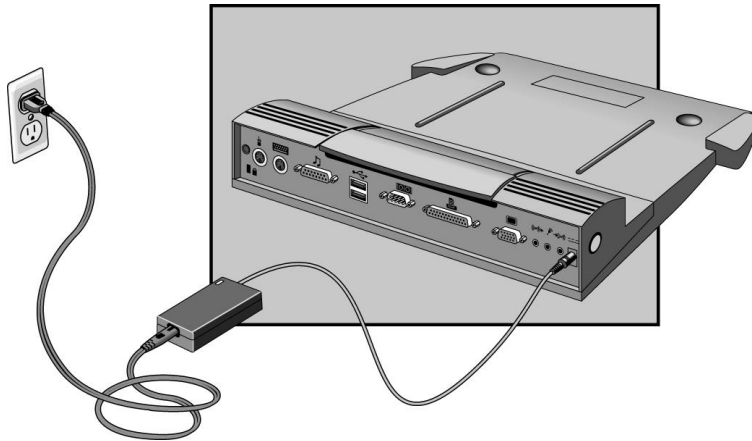

2. Slide the OmniBook's rear port door to the left.

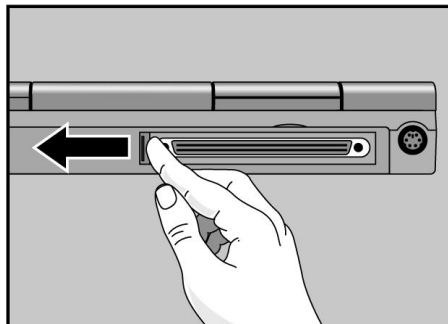

3. Place the OmniBook on the port replicator platform, with the back of the computer facing the port replicator's docking connector.

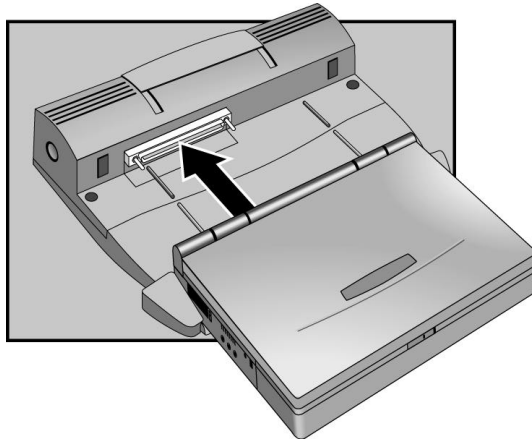

4. Position your fingers on the platform grips as shown below. Use your thumbs to push the computer firmly toward the port replicator until the OmniBook slides into place.

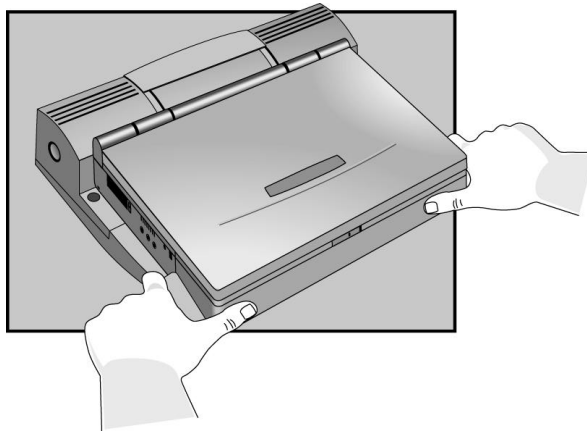

To undock the OmniBook

1. Raise the release lever at the top of the port replicator.
2. After removing the OmniBook, push the release lever back into place.

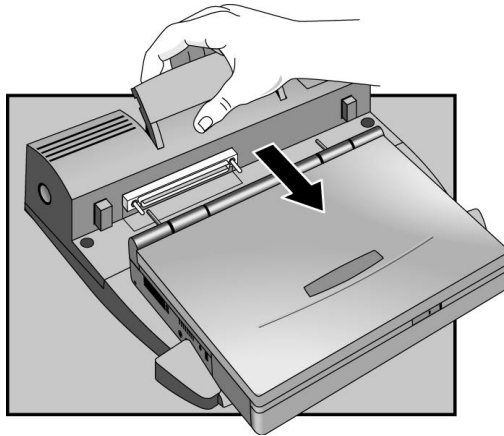

To make an infrared connection

The infrared (IR) port is on the back panel. It provides wireless, serial communication between the OmniBook and other IR-equipped devices such as printers and other OmniBooks.

Note

By default, the IR port is *not enabled*. You must install the appropriate IR driver and enable it in BIOS Setup. For details, refer to the drivers' Readme files located in \OmniBook\drivers\Win95.

Infrared port

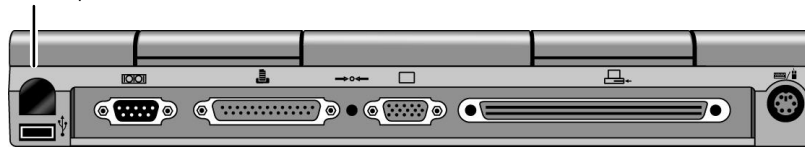

- Line up the OmniBook's IR port and the other IR port in as straight a line as possible. The two ports should be no more than 1 meter apart, with no obstructions in between. Noise from nearby equipment can cause transmission errors.

To check the status of communications, there is an Infrared Monitor in the Control Panel.

Expanding the OmniBook

Expanding the OmniBook

This chapter describes some of the optional equipment that can be added to the OmniBook—components installed inside the computer rather than connected to the computer's I/O ports.

This chapter describes procedures to expand or update the capabilities of your OmniBook, including how to

- ◆ Install a hard disk drive.
- ◆ Install a RAM expansion module.

Installing a Hard Disk Drive

This section describes how to

- ◆ Replace a hard disk drive.
- ◆ Remove the hard disk drive carrier.
- ◆ Create a hibernate partition for a new hard disk drive.

To replace the hard disk drive

You'll need a small Phillips screwdriver to remove the hard disk drive.

1. From the Start menu, shut down the OmniBook.
2. Unplug the ac adapter, if present, and remove the battery.
3. Remove the two screws from the bottom of the hard disk drive holder.

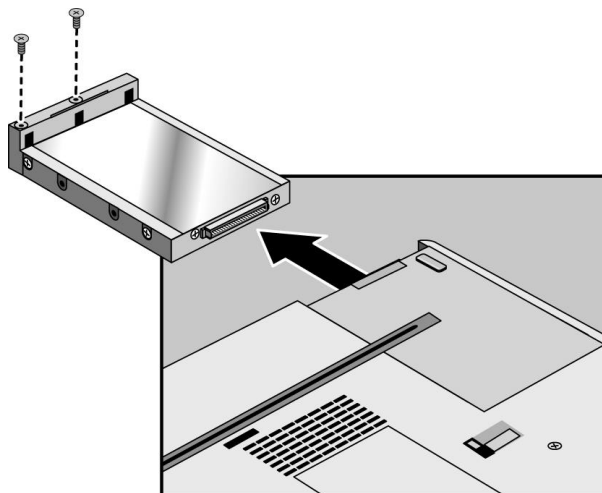

4. Pull out the hard disk drive.
5. Insert the new drive and replace the hard disk drive screws.
6. Insert the battery.

Expanding the OmniBook
Installing a Hard Disk Drive

Important

If you are installing a new hard disk drive, you should create a Hibernate partition on the drive before loading any software—see page 6-5 for instructions.

To replace the hard disk drive holder

If you are installing a new hard drive that does not have a plastic holder, you can remove the holder from the old hard drive.

You'll need a small Phillips screwdriver for this procedure.

1. Remove the four screws from the sides of the carrier.
2. Swing out the free end of the hard drive about 90°, then gently pry off the connector from the hard drive.

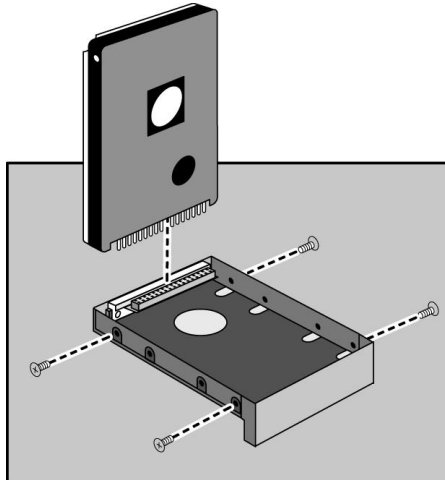

To create a Hibernate partition

If you do not have an OmniBook 3000 Support Utility floppy disk, create one now. After inserting a formatted floppy disk in the floppy drive, do one of the following:

- On a factory software installation, click Start, Programs, OmniBook, Create Support Utility Disk.
- On any computer, run makesupp.bat from the \OmniBook\Drivers\Hputils directory on the OmniBook 3000 *Recovery CD*. (Note: Use the \OmniBook\Drivers\Hputils directory, not \OmniBook \Hputils).
- On any computer, download the Support Utility software package from the OmniBook website (<http://www.hp.com/go/omniBook>). Follow the instructions provided.

1. Connect the ac adapter to the OmniBook.
2. Insert the Support Utility disk in the floppy disk drive or insert the bootable Recovery CD in your CD-ROM drive. (If you are using the Recovery CD to boot from, verify that the CD-ROM is listed before the Hard Drive in the Boot menu by rebooting and pressing F2, then look at the Boot menu.)
3. Reset the OmniBook. The DOS Startup menu appears.
4. Choose option 3:
Create Hibernate Partition (erases Hard Disk)
5. Choose Y to Continue.
6. When prompted for “Hibernate” partition size, we recommend that you create a 144-MB partition, the same as the factory default.

Do not interrupt the Hibernate partition process or unplug the ac adapter until complete.

Installing RAM Expansion Modules

This section describes how to

- ◆ Install a RAM module.
- ◆ Remove a RAM module.

To install a RAM expansion module

The OmniBook provides an optional memory expansion slot for installing up to two 3.3-volt EDO RAM expansion modules.

Your OmniBook's computer chips are extremely static-sensitive. Static electricity can permanently damage computer chips. Carefully read the following caution information.

CAUTION

Handle the RAM module only by its edges. Otherwise, you may damage the module due to electrostatic discharge. Static electricity can permanently damage computer chips. It is therefore important to discharge the static electricity from your body before installing the memory module. Discharge your body's electricity by touching the metal shielding around the connectors on the rear of the OmniBook computer.

You'll need a small Phillips screwdriver to complete this procedure.

1. From the Start menu, shut down the OmniBook.
2. Unplug the ac adapter, if present, and remove the battery.
3. Remove the hard disk drive (see page 6-3).

4. Slide the RAM cover about 3 mm toward the hard disk drive opening, then lift off the cover.

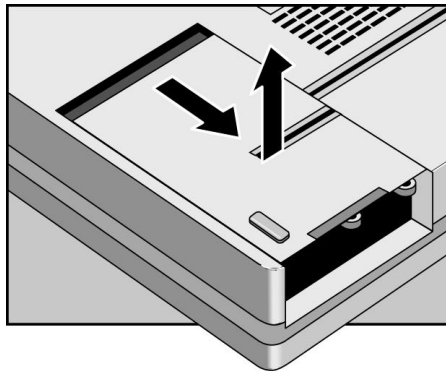

4. Insert the RAM board into the connector at about a 30° angle, then press down at both sides until it latches.

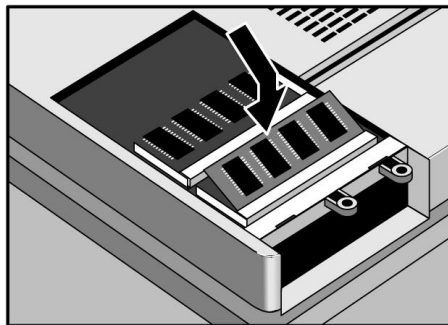

5. Place the RAM cover about 3 mm from its closed position, then slide it closed.
6. Insert the hard disk drive and battery.

To remove a RAM expansion module

You'll need a small Phillips screwdriver to complete this procedure.

1. From the Start menu, shut down the OmniBook.
2. Unplug the ac adapter, if present, and remove the battery.
3. Remove the hard disk drive (see page 6-3).
4. Slide the RAM cover about 3 mm toward the hard disk drive opening, then lift off the cover.

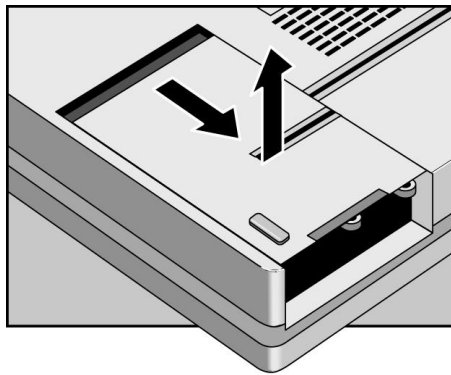

5. Release the two latches at the sides of the RAM board.

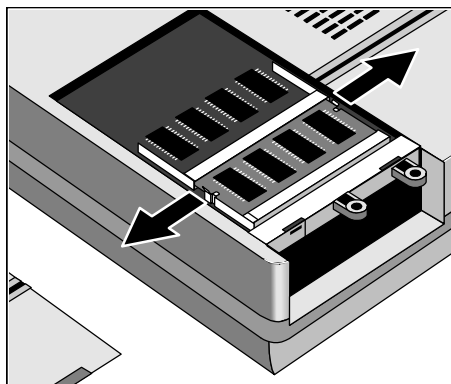

When you release the latches, the free edge of the board pops up.

6. Pull the board out of the connector.

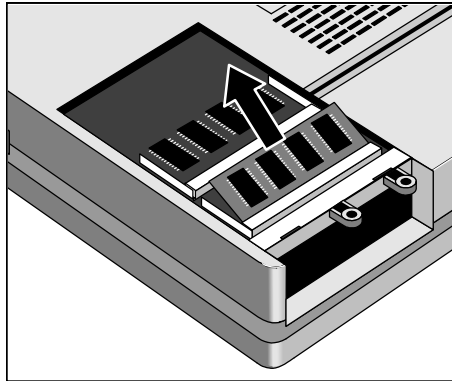

7. Insert the hard disk drive and battery.

Installing Software

Installing Software

This chapter has instructions for installing new software or recovering original OmniBook software. You can install or recover a factory-installed version of the Windows 95 operating system, drivers for other operating systems, OmniBook files.

This section describes how to

- ◆ Locate files on the *Recovery CD*.
- ◆ Set up a PC Card or parallel port CD-ROM drive.
- ◆ Install an operating system and drivers.
- ◆ Install OmniBook files, such as the *User's Handbook*.

Installing Drivers

If you have formatted the OmniBook's hard disk drive and loaded your company's disk image, the *Recovery CD* provides OmniBook-specific software and device drivers that you can add to your build image.

This section describes how to

- ◆ Find individual audio, video, infrared, and PC Card drivers for various operating systems including the following:
 - MS-DOS.
 - Windows for Workgroups.
 - Windows NT 4.0.

Each driver has a README file with instructions.

- ◆ Install a PC Card or parallel port CD-ROM drive from a floppy boot disk. A CD-ROM drive is required for installing drivers from the *Recovery CD*.
- ◆ Install an operating system (other than Windows 95 factory-installation).

Hint

Add the online *User's Handbook* to your custom installation. See page 7-9.

Contents of the Recovery CD

Directory	Contains
README.TXT text file	Instructions for using the <i>Recovery</i> CD.
RECOVER\	
ENC	Encrypted Microsoft Windows 95 recovery files. (Usable only in conjunction with the <i>Support Utilities</i> disk.)
BOOTDISK	For creating your own copy of a boot disk (like the FAT32 <i>Support Utility</i> disk).
FILE.CHK	Checksum list (also for FAT32).
OMNIBOOK\	
HPUTILS	Use this to install the online <i>User's Handbook</i> or to copy the OmniBook Notes and Support files to the \OmniBook directory on your hard drive.
DRIVERS	Use this to manually install individual audio, video, infrared, and PC-Card (PCMCIA) drivers for Windows NT 4.0, Windows 95, and Windows for Workgroups. Look for the specific driver for the specific version of your operating system. Each driver has a README file with instructions.
MANUALS	Use this for direct viewing of the online <i>User's Handbook</i> from the CD, not for its installation.

The following sections tell you how to set up and start a recovery installation. Refer to the README text file on the *Recovery* CD for step-by-step instructions.

To set up a PC Card or parallel port CD-ROM drive

If you are using the *Support Utility* disk with the Recovery CD and do not have the OmniBook internal CD-ROM drive, you'll need to edit the CONFIG.SYS and AUTOEXEC.BAT files on the *Support Utility* disk so that it can recognize the external CD-ROM drive. The required device-drivers statements should come from the CD-ROM manufacturer.

What you'll need from your CD-ROM manufacturer

- The names of the device drivers to copy to the *Support Utility* disk.
- The `device=drivers` statements to add the CONFIG.SYS file.
- Statements for the CD-ROM drive to add to the AUTOEXEC.BAT file.

Hint

Both the CONFIG.SYS and AUTOEXEC.BAT files contain comments that should help your CD-ROM manufacturer advise you in editing the files to meet the particular requirements for your device.

1. Connect the ac adapter to the OmniBook.
2. If you do not have an OmniBook 3000 *Support Utility* disk, create one now. After inserting a formatted floppy disk: in the floppy drive, do one of the following:
 - On a factory software installation, click Start, Programs, OmniBook, Create Support Utility Disk.
 - On any computer, run **makesupp.bat** from the \OmniBook\Drivers\Hputils directory on the OmniBook 3000 Recovery CD.
 - On any computer, download the Support Utility software package from the OmniBook website. Follow the instructions provided.
3. Insert the *Support Utility* disk in the OmniBook floppy drive.
4. Copy the device drivers from the installation software provided with the CD-ROM drive to the *Support Utility* disk into the A:\tools directory.
5. Add the `device=driver` statements to the CONFIG.SYS file on the Support Utility disk. The device statements should immediately follow the [USERCD] label.
6. Check the AUTOEXEC.BAT file to make sure that the CD-ROM drive is assigned as drive G.

To install an operating system

You provide the software to install an alternate operating system. The *Recovery CD* provides the OmniBook-specific drivers to configure your custom system. The drivers for Windows 95, Windows NT 4.0, and Windows for Workgroups are located

- On the *Recovery CD* ROM, under \OmniBook\Drivers.
- On the OmniBook hard drive under C:\OmniBook\Drivers.
- On the OmniBook website at <http://www.hp.com/go/omnibook> . This website contains the latest updates of software drivers.

The *Corporate Evaluator's Guide*, also available at our website, provides complete information about installing alternate operating systems, as well as how to configure the OmniBook in a corporate, networked environment.

Different versions of an operating system require different drivers, so make sure to select the appropriate driver.

The equipment you need are the OmniBook, its ac adapter, a floppy disk drive, and a CD-ROM drive. You also need the *Support Utility* floppy disk. If you have not already created one, see page 7-5.

CAUTION

Before you start installing a new operating system, make sure the drivers you need will be accessible after the installation . Copy them from the OmniBook website or the hard drive to floppy disks, or use the *Recovery CD* with a CD-ROM drive.

1. Connect the ac adapter to the OmniBook.
2. Install the operating system.
3. Install the OmniBook-specific drivers according to the instructions in the README files that accompany the drivers.

Hint

Add the online *User's Handbook* to your custom installation. See page 7-9.

Recovering OmniBook Files

This section describes how to

- ◆ Install the Windows 95 operating system (factory-installation).
- ◆ Install the OmniBook online *User's Handbook*.
- ◆ Use the *Recovery CD* programming service.
- ◆ Recover a damaged *Recovery CD* or hard disk drive.
- ◆ Update the OmniBook BIOS.

To install Windows 95 (factory-installation)

The following procedure describes how to install the Windows 95 operating system that came with your OmniBook. These steps will format the hard disk drive. Back up any files you would like to save before installing Windows 95.

The entire recovery process takes approximately 1 hour. To install the Windows 95 operating system, you'll need a CD-ROM drive and the *Recovery CD*.

1. Connect the ac adapter to the OmniBook.
2. If you have an internal CD-ROM drive, install it.

-or-

If you have a PC Card or parallel port CD-ROM drive, connect it (see page 7-5 for instructions about modify the *Support Utility* disk).

3. Insert the *Recovery CD* in CD-ROM drive.
4. Insert the *Support Utility* disk in the floppy disk drive.
5. Press CTRL+ALT+DEL to reboot the OmniBook. The MS-DOS Startup menu appears.
6. Choose "Recover Windows 95 from OmniBook Recovery CD."
7. Follow the setup instructions on the screen.
8. When prompted, select "Create Hibernate Partition."
We recommend that you create a 144-MB partition—the same as the factory default.
9. Press CTRL+ALT+DEL to reboot the OmniBook. The MS-DOS Startup menu appears.
10. Choose "Recover Windows 95 from OmniBook Recovery CD."

The recovery process can take up to an hour. Do not interrupt the recovery process or unplug the ac adapter until recovery is completed.

To install the online *User's Handbook*

You can install the online *User's Handbook* from the *Recovery CD*. This also installs OmniBook Notes and Support files to your hard drive.

1. Connect the ac adapter to the OmniBook.
2. If you have an internal CD-ROM drive, install it in the OmniBook.

–or–

If you have a PC Card or parallel port CD-ROM drive, connect the PC Card or parallel port CD-ROM drive. See “To set up a PC Card or parallel port CD-ROM drive” on page 7-5.

3. Insert the *Recovery CD* in the CD-ROM drive.
4. From the \OmniBook\Hputils\Disk1 directory on the CD, double-click **setup.exe**. The OmniBook Application Software Setup screen appears.
5. Click Next.
6. Click “OmniBook Online Documentation.”
7. Click Install Now.

To use the Recovery CD programming service

If you need to recover an operating system, OmniBook drivers, or any other program on the *Recovery CD*, but do not have access to a CD-ROM drive, HP Service can recover these files for you. The cost is a standard charge equal to one-half the hourly labor rate. This service is available for the OmniBook *Recovery CD* only. Microsoft CDs and other non-HP CDs do not qualify for this service.

To replace a damaged Recovery CD

If you lose or damage the *Recovery CD*, take your OmniBook and Certificate of Authenticity to an HP Service Center to be replaced. If you mail your OmniBook for this service, you *must* provide a photocopy of the Certificate of Authenticity along with payment.

To update the OmniBook BIOS

Hewlett-Packard may update the BIOS to enhance the capabilities of the OmniBook 3000. Updates will be available from HP Electronic Support Services.

C a u t i o n

Because a BIOS update replaces the previous version, it is very important you follow these instructions exactly. Otherwise, the OmniBook may be damaged.

The BIOS update process resets the configuration settings in the BIOS Setup Utility except for the PC Identification and Password.

1. From the Start menu, shut down the OmniBook.
2. Connect the ac adapter to the OmniBook.
3. Remove any PC Cards.
4. Insert the BIOS Update disk in the floppy disk drive.
5. Press the blue power button.
6. When prompted, choose the correct language.
7. When prompted, press C. This starts a process that takes approximately 1 minute.
8. When prompted, press the system-off button.

Do not interrupt the update process.

———— Troubleshooting

Troubleshooting

If you run into problems with your OmniBook, you can use the suggestions in this chapter for getting back on track.

If you have questions that this manual doesn't answer, you can

- Look at the online Help for Windows and other applications.
- Find technical information about the OmniBook on the Internet—visit the Support website at <http://www.hp.com/go/omnibook>.
- See other books about Windows, MS-DOS, and other applications. Check your local library or bookstore.
- Contact your dealer, or contact Hewlett-Packard—see the OmniBook *Support and Service* booklet or OmniBook Support in the online OmniBook Library.

Get information about system resources (interrupts, addresses, and memory)—see “Software System Resources” on page 9-5.

Solving Problems

If your OmniBook has a problem, find the symptom below that matches your situation. Try the suggestions one at a time.

Accessory Problems

If a port replicator port isn't working

- Check that ac power is connected.
- Try using the corresponding OmniBook port, while undocked.

If you can't boot from a CD in the CD-ROM drive

- Check boot order in BIOS Setup (Boot menu).
- Make sure you are using an internal OmniBook CD-ROM drive. You cannot boot from an external CD-ROM drive.
- Check that the CD is bootable.
- Reset the OmniBook.

If the Zip drive isn't working

- Make sure the Zip drive is seated correctly—remove and reinsert.
- Check that drivers have been installed.
- Reset the OmniBook.

Audio Problems

If sounds aren't audible

- Check that the volume is not muted. Pressing Fn+F7 toggles muting on and off.
- Press Fn+UP-ARROW several times to make sure the volume isn't set too low.
- Check settings in BIOS Setup—from the System Devices menu, check that Audio is enabled.
- Check for sound resource conflicts in BIOS Setup or Windows Device Manager.

If sound doesn't record

- Check the playback or recording sound levels.
- Check settings in BIOS Setup—from the System Devices menu, check that Audio is enabled.
- Check software controls for recording sound (Sound Recorder under Program Accessories).

Display Problems

If the OmniBook is on, but the screen is blank

- Press the space bar to see if the computer is in Standby mode.
- Press Fn+F1 or Fn+F2 to adjust the display.
- Press Fn+F5 in case the internal display was disabled. (Do this three times to return to the state you started from.)
- If the OmniBook is cold, allow it to warm up.

If the screen is difficult to read

- Check whether the display resolution is set to its default setting, 1024 × 768 (XGA). Check this in Start, Settings, Control Panel, Display, Settings.

Floppy Disk Drive Problems

If the OmniBook's floppy disk drive doesn't work

- Try using an alternate connection (with or without floppy cable).
- Check settings in BIOS Setup—from the System Devices menu, check FDD Controller. Also check the boot order from the Boot menu.

Hard Disk Drive Problems

If the OmniBook's hard drive doesn't spin

- Check the power source.
- Remove and reinsert the hard drive. See page 6-3 for instructions.

If the hard disk makes buzzing or whining noise

- Back up the drive immediately.
- Check for alternate noise sources, such as a PCMCIA drive or fan.

If files are corrupted

- Run a virus scan program.
- Boot to DOS and run CHKDSK to look for problems, run CHKDSK /f to fix.
- Run Scandisk surface scan to check the platter.
- Use Recovery CD to recover files that are corrupted.

Keyboard, Mouse, and TouchPad Problems

If the pointer is difficult to control

- Adjust the pointer settings using the Mouse icon in Control Panel.

If the TouchPad doesn't work

- Make sure you don't have an external mouse connected to the OmniBook.
- If you just disconnected an external mouse, try exiting and restarting Windows to make the OmniBook TouchPad active again.
- Press the blue power button to suspend the OmniBook, then turn it on again without moving the pointer.
- Reset the OmniBook.

If the embedded numeric keypad doesn't work

- Press and hold the Fn key to temporarily access the embedded keypad.

If a PS/2 keyboard and mouse with Y-adapter don't work

- This configuration is not supported. (You can use a port replicator or a serial mouse.)

If you have problems with the TouchPad response

- Check settings in Control Panel.

Infrared Problems

If you have problems with infrared communications

- Make sure the infrared light path is not blocked.
- Check settings in BIOS Setup—from the System Devices menu, check that Infrared Port is enabled.
- For infrared communications, an infrared driver must be installed and a BIOS Setup setting must be enabled. For details, refer to the drivers' Readme files located in \OmniBook\drivers\Win95.
- Check that only one application is using the infrared port.
- If you have a Standard IR and Fast IR machine communicating with each other, make sure that they are set to the highest *common speed* (115200 baud).
- Remove any PC Cards. An IRQ conflict is possible if two PC Cards are plugged in.

If an infrared printer doesn't print

- Make sure the infrared light path is not blocked.
- An infrared driver must be installed and the BIOS Setup setting must be enabled. For details, refer to the drivers' Readme files located in \OmniBook\drivers\Win95.
- In Windows Help, use the Print Troubleshooter.

Memory Problems

If a message says you are out of memory

To find out how much memory is in your OmniBook, run the BIOS Setup Utility (reset the computer and press F2 when prompted), Main menu.

- In Windows Help, use the memory troubleshooter.
 - Check for amount of free drive space.
 - If you are having memory problems running MS-DOS programs, in Windows Help use the MS-DOS troubleshooter.
-

PC Card (PCMCIA) Problems

If the OmniBook doesn't recognize a PC Card

- Remove and reinsert the PC card.
- If the card requires an IRQ, check that there is one available. Look in Windows Device Manager.
- Check the OmniBook website for information about supported PC Cards.
- Try the card in another computer.

Performance Problems

If the OmniBook's internal clock loses time

- Plug in ac adapter for 24 hours to charge backup battery.

If the OmniBook gets hot

- It is normal for the computer to get hot.
- Make sure the air vents are clear.
- DOS games and other programs that drive CPU usage toward 100% can contribute to the temperature.

If the OmniBook pauses or runs sluggishly

- This may be normal Windows 95 behavior (background processing can affect response time).
- If the hard disk has spun down to conserve power, it can take several seconds to spin up. Run BIOS Setup and increase the hard disk time-out.
- Certain background operations (such as virus scans) can affect performance while they're running.
- Some file browsers may be unresponsive while they're processing a graphic image or waiting for broken network connections to time out.
- Run BIOS Setup and try turning off smart CPU mode.
- Install additional memory if Windows is spending a lot of time swapping to disk.
- Check amount of available free disk space.

Power and Battery Problems

If the OmniBook turns off immediately after it turns on

- Battery power is probably extremely low. Plug in the ac adapter, or insert a charged battery pack.

If the OmniBook keeps beeping

- Battery power may be low. Save your work, quit immediately, and replace the battery or plug in the ac adapter.

If the OmniBook has a short operating time

- Try conserving power using any of the suggestions listed under “To save battery power” on page 4-10.
- If the operating time has gotten shorter and the battery is more than a year or two old, you may need to replace the battery.
- Turn down the display brightness.
- Check the Power Management settings in BIOS Setup. Make sure they are set to Maximum Power Savings.

If the battery doesn't charge

- Make sure the ac adapter is plugged into the power source.
- Check that the battery is fully installed and locked in place.
- Turn off the OmniBook, then check that the battery contacts are clean and that the ac adapter cables are fully plugged in.
- Move the OmniBook away from any nearby heat source. Unplug the ac adapter and allow the battery to cool down. An elevated battery temperature prevents charging.
- If available, try another battery and ac adapter.

If the secondary battery doesn't charge

- The OmniBook's secondary battery doesn't charge until the main battery is fully charged.

If the OmniBook stops responding

- Press the blue power button and wait a few moments until the icons on the status panel stabilize. Then press the blue button again to turn the OmniBook back on.

If necessary, press CTRL+ALT+DEL to reboot.

- If nothing happens, insert a paper clip into the system-off button on the back side of the OmniBook, between the parallel and VGA-out ports.

If the OmniBook doesn't suspend automatically

- If you have a connection to another computer, the OmniBook doesn't suspend if the connection is actively in use.
- Check the time-out settings in the BIOS Setup Utility. Make sure the Suspend time-out is enabled.

If the OmniBook doesn't suspend immediately

- If the OmniBook is performing an operation, it normally waits for the operation to finish.

Printing Problems

If a serial or parallel printer doesn't print

- Check that you are using a proper cable or cable adapter, and that the printer is on.
- Check for paper in the printer or other printer errors.
- Make sure the printer cable is secure at both ends.

If an infrared printer doesn't print

- Make sure the infrared light path is not blocked.
- Check for paper in the printer or other printer errors.
- Make sure Windows is running—infrared printing is supported only while Windows is running.
- An infrared driver must be installed and the BIOS Setup setting must be enabled. For details, refer to the drivers' Readme files (located in \Omnibook\Drivers).
- In Windows Help, use the Print Troubleshooter.

If the left edge of printed output is missing

- If the printer you are using is a 600-dpi (dots per inch) printer, try selecting a compatible printer driver for a 300-dpi printer. For example, for a 600-dpi HP LaserJet printer, try using the HP LaserJet IIIsi driver (300-dpi). Certain applications may not work properly with 600-dpi printers.

Serial and Parallel Problems

If the serial mouse doesn't work

- First, make certain you followed the manufacturer's installation instructions completely and everything necessary to install the mouse properly.
- Make sure the serial port option of the setup program is set to the same port that is selected for the mouse driver.
- Set the mouse device driver to the corresponding COM port which is selected for the serial port option.
- Check the port connection (may be loose).

If a serial modem doesn't work properly

- In Windows Help use the modem troubleshooter.
- Check the port connection (may be loose).

If an I/O card stops communicating properly

- It may have been reset if the OmniBook suspended or turned off. Exit and restart the application.

If the serial or parallel port is not working

- Check settings in BIOS Setup (under System Devices). Make sure that Parallel and Serial are enabled.
- Check the port connection (may be loose).

Startup Problems

If the OmniBook doesn't respond at turn-on

- Connect the ac adapter.
- Press blue power to try turning on the unit.
- Reset the OmniBook.

If you get no response, remove the battery and ac adapter—then plug in the ac adapter and try resetting. If you still get no response, the unit requires service.

If the OmniBook doesn't boot from battery power

- Make sure the battery is properly inserted.
- Check battery level on status panel and battery LEDs.
- Check battery contacts. If available, try another battery.

If the OmniBook doesn't boot from the floppy disk drive

- Check the floppy drive cable connection.
- Try using an alternate connection (with or without floppy cable).

Check boot order in BIOS Setup. From the Boot menu, make sure that Diskette Drive appears *above* Hard Drive in the boot list.

**Specifications and Regulatory
Information**

Specifications and Regulatory Information

Your OmniBook is designed to provide trouble-free operation. The following suggestions can help you maintain its dependability:

- Observe the temperature limits and other specifications listed in the next section.
- If you have problems, see the problem-solving suggestions in chapter 8 of this manual.
- If you think your OmniBook might need repair service, see the warranty and service information in the *Support and Service* booklet.

To contact Hewlett-Packard

If you have questions that this manual and the online OmniBook manuals don't answer (even after looking in the contents and index), you can contact Hewlett-Packard at the address or phone number listed in the *Support and Service* booklet or in OmniBook Support in the online OmniBook Library. Please have your OmniBook with you.

To clean the OmniBook

You can clean the OmniBook with a soft cloth dampened either in clean water or in water containing a mild detergent. Do not use an excessively wet cloth nor allow water inside the case. Do not use any abrasive cleaners, especially on the display. *Do not apply any cleaner directly to the display.* Instead, apply the cleaner to a soft cloth and then gently wipe the display. You can clean the keyboard with a vacuum cleaner to remove accumulated dust.

Hardware Specifications

Physical Attributes	Size: 30.30 × 23.73 × 5.24 cm (11.93 × 9.34 × 2.06 in) closed. Weight: 3.03 kg (6.7 lb).
Processor and Bus Architecture	233- or 200-MHz Intel Pentium processor with MMX technology. Intel sub-2V low-power processor. 512-KB burst-synchronous L2 cache. 32-bit PCI bus.
Graphics	13.3-inch XGA active-matrix (TFT) display (1024 × 768 × 64K colors). PCI local bus video; 128-bit graphics controller with 2-MB video RAM. Zoomed Video enabled.
Power	Rechargeable Lithium Ion battery with built-in four-level fuel gauge. Low-battery warning. Suspend/resume capability. Battery life: 2.5-3 hours (varies with type of usage) for one battery. AC adapter 100 to 240 Vac (50 to 60 Hz) input; 19 Vdc, 2.4 A output.
Mass Storage	4.0 GB or 2.1GB removable hard drive. 1.44-MB internal/external floppy drive (swap with optional 20X CD-ROM drive or optional second battery). Optional removable 20X CD-ROM drive (20X maximum, 14X average). Optional removable Zip drive.
RAM	16-MB RAM on board. Two slots for RAM expansion up to 128 MB (together with the 16 MB on the main board give a total of 144 MB).
Audio System	16-bit, Sound Blaster Pro-compatible. MIDI support with optional port replicator. Stereo sound via two built-in speakers. Built-in microphone. Line-in, line-out, and microphone-in. 3D enhanced audio.
Keyboard and Pointing Device	87/88-key touch-type QWERTY keyboard. Embedded keypad. TouchPad.

Specifications and Regulatory Information

Hardware Specifications

Input/Output	Universal Serial Bus (USB). 9-pin, 115,200-bps serial (16550 UART). 25-pin bi-directional ECP/EPP parallel. Video-out (up to 1024 × 768 × 64K colors) at up to 75-Hz refresh rate. PS/2 keyboard/mouse. 4-Mbps IrDA-compliant infrared.
Expandability	One Type III or two Type II 16-/32-bit PC Card slots. CardBus enabled. Plug-in module bay for accessory modules. Optional port replicator with two USB, serial, parallel, video-out (up to 1024 × 768 × 64K colors), keyboard, PS/2 mouse, audio, MIDI/joystick, and power-in ports.
Preinstalled Software	Microsoft Windows 95. Windows 95-compatible Plug and Play. Advanced Power Management (APM 1.2). DMI 1.1 under Windows 95 with HP TopTools. Online documentation. OmniBook Recovery CD-ROM included. Centralized worldwide BIOS and driver update service.
Windows NT Support	Windows NT 4.0 certified. APM 1.2 and PC Card Plug-and-Play support for Windows NT 4.0.
Security Features	Password protection. DMI-accessible electronic serial number. Kensington Microsaver lock slot.
Environmental Limits	Operating temperature: 5 to 35 °C (41 to 95 °F). Operating humidity: 20 to 90 percent RH (5 to 35 °C). Storage temperature: -20 to 50 °C (-4 to 122 °F).

Software System Resources

Below are default values for the system resources. To see other, non-default possibilities, refer to the BIOS Setup Utility, which lists port and audio device configurations in the Input/Output menu.

System Resources

The tables in this section show typical resource usage as set up by the OmniBook BIOS. Plug-and-play operating systems, drivers, and SCU settings may change some of the entries.

System Interrupts

	System timer
	Keyboard
	Cascade to IRQ 9
	Free (or COM2 infrared port, if enabled)
	COM1 (serial port)
5	Crystal sound
	Floppy drive
	LPT1 (ECP parallel port)
	Real-time clock
9	Free (or MIDI, if enabled)
	Universal Serial Bus (USB) - assigned by Windows 95 driver
	CardBus controller - assigned by Windows 95 driver
	TouchPad
	Numeric data processor
	Internal hard disk (primary IDE controller)
5	Internal CD-ROM drive (secondary IDE controller)

System Memory

	- 9FFFF	System memory
A	- BFFFF	Video
C	- CBFFF	Video BIOS
CC	- DFFFF	Free (see below)
E	- FFFFF	System BIOS

Specifications and Regulatory Information
Software System Resources

Valid uses for memory addresses CC000-DFFFF:

- Upper memory blocks (UMBs).
- PC Card memory windows.

System Input/Output Addresses (100 -3FF)

-	Secondary HDD controller (internal CD-ROM)
F - F	Internal hard disk
-	Joystick
- F	Crystal sound
	Secondary HDD controller (internal CD-ROM)
- F	LPT1 (printer port)
- B	Sound
B - BB	VGA adapter
C - DF	VGA adapter
E - E	PCMCIA controller
F - F5	Floppy controller
F	Primary HDD controller
F	Floppy controller
F - FF	COM1 (serial port)

DMA Channels

	Sound record
	Sound playback
	Floppy drive
	LPT1 (ECP parallel port)
	Cascade
5	Free
	Free
	Free

Safety Information

Power Cords

The power cord supplied with the OmniBook ac adapter should match the plug and voltage requirements for your local area. Regulatory approval for the ac adapter has been obtained using the power cord for the local area. However, if you travel to a different area and need to connect to a different outlet or voltage, you should use one of the power cords listed below. To purchase a power cord (including one for a country not listed below) or a replacement ac adapter (HP part number F1377A), contact your local Hewlett-Packard dealer or Sales and Service office.

Power Cords

Country	Rated Voltage and Current	HP Part Number
Canada Mexico Philippines Taiwan United States	125 Vac (3 A)	8120-6313
East and West Europe Egypt Saudi Arabia	250 Vac (2.5 A)	8120-6314
Hong Kong Singapore United Kingdom	250 Vac (2.5 A)	8120-6315
Australia New Zealand	250 Vac (2.5 A)	8120-6312
Japan	125 Vac (3 A)	8120-6316
India South Africa	250 Vac (2.5 A)	8120-6317
People's Republic of China	250 Vac (2.5 A)	8120-8373

W A R N I N G

Working In Comfort

Improper use of keyboards and other input devices has been associated with ergonomic injury. For information about reducing your risk, see the “Working in Comfort” instructions provided in the online OmniBook Library and in Windows Help. They are also available at our website, <http://www.hp.com/mcd/ergo>.

Battery Safety

- To avoid risk of fire, burns, or damage to your battery pack, do not allow a metal object to touch the battery contacts.
- The battery pack is suitable for use only with compatible OmniBook models. Check the *Support and Service* booklet for your local HP contact.
- Do not disassemble. There are no serviceable parts inside. Do not dispose of the battery pack in fire or water.
- Handle a damaged or leaking lithium-ion battery with extreme care. If you come in contact with the electrolyte, wash the exposed area with soap and water. If it contacts the eye, flush the eye with water for 15 minutes and seek medical attention.
- Do not expose the battery pack to high storage temperatures (above 60 °C, 140 °F).
- When the battery is not in use, store it in the battery pouch provided.
- When discarding a battery pack, contact your local waste disposal provider regarding local restrictions on the disposal or recycling of batteries.
- To obtain a replacement battery, contact your local dealer or HP sales office.
- Do not charge the battery pack if the ambient temperature exceeds 45 °C (113 °F).

Laser Safety

The CD-ROM drive used with the OmniBook is certified as a Class 1 laser device according to the U.S. Department of Health and Human Services (DHHS) Radiation Performance Standard and International Standards IEC 825 / IEC 825-1 (EN60825 / EN60825-1). This device is not considered harmful, but the following precautions are recommended:

- Ensure proper use by reading and following the instructions carefully.
- If the unit requires service, contact an authorized HP service center—see the *OmniBook Support and Service* booklet.
- Do not attempt to make any adjustment of the unit.
- Avoid direct exposure to the laser beam—do not open the unit.

CLASS 1 LASER PRODUCT
LASER KLASSE 1

LED Safety

The infrared port located on the back panel of the OmniBook is classified as a Class 1 LED (light-emitting diode) device according to International Standard IEC 825-1 (EN60825-1). This device is not considered harmful, but the following precautions are recommended:

- If the unit requires service, contact an authorized HP service center—see the *OmniBook Support and Service* booklet.
- Do not attempt to make any adjustment of the unit.
- Avoid direct eye exposure to the infrared LED beam. Be aware that the beam is invisible light and cannot be seen.
- Do not attempt to view the infrared LED beam with any type of optical device.

CLASS 1 LED PRODUCT
LEDSCHÜTZKLASSE 1 PRODUKT

Regulatory Information

This section presents information that shows how the OmniBook 3000 complies with regulations in certain regions. Any modifications to the OmniBook not expressly approved by Hewlett-Packard could void the authority to operate the OmniBook in these regions.

U.S.A.

The OmniBook 3000 generates and uses radio frequency energy and may interfere with radio and television reception. The OmniBook complies with the limits for a Class B computing device as specified in Part 15 of FCC Rules, which provide reasonable protection against such interference in a residential installation. In the unlikely event that there is interference to radio or television reception (which can be determined by removing the unit's batteries and ac adapter), try the following:

- Reorienting or relocating the receiving antenna.
- Relocating the OmniBook with respect to the receiver.
- Connecting the OmniBook ac adapter to another power outlet.

Connections to Peripheral Devices

To maintain compliance with FCC Rules and Regulations, use properly shielded cables with this device.

For more information, consult your dealer, an experienced radio/television technician, or the following booklet, prepared by the Federal Communications Commission: *How to Identify and Resolve Radio-TV Interference Problems*. This booklet is available from the U.S. Government Printing Office, Washington, DC 20402, Stock Number 004-000-00345-4. At the first printing of this manual, the telephone number was (202) 512-1800.

Declaration of Conformity

Responsible Party: Hewlett-Packard Company
Manager of Corporate Product Regulations
3000 Hanover Street
Palo Alto, CA 94304
(415) 857-1501
declares that the product(s)
Trade name: Hewlett-Packard Company
Product name: HP OmniBook 3000

Complies with Part 15 of the FCC Rules. Operation is subject to the following two conditions:

1. This device may not cause harmful interference, and
2. This device must accept any interference received, including interference that may cause undesired operation.

Canada

This digital apparatus does not exceed the Class B limits for radio noise emissions from digital apparatus as set out in the radio interference regulations of the Canadian Department of Communications.

Le présent appareil numérique n'émet pas de bruits radioélectriques dépassant les limites applicables aux appareils numériques de Classe B prescrites dans le règlement sur le brouillage radioélectrique édicté par le Ministère des Communications du Canada.

Japan

この装置は、情報処理装置等電波障害自主規制協議会（VCCI）の基準に基づく第二種情報技術装置です。この装置は、家庭環境で使用することを目的としていますが、この装置がラジオやテレビジョン受信機に近接して使用されると、受信障害を引き起こすことがあります。

取扱説明書に従って正しい取り扱いをして下さい。

Energy Saving Law

Product: HP OmniBook 3000.
Energy Efficiency: 16.3 watts (power consumption).
Manufacturer: Hewlett-Packard Company.

Declaration of Conformity

Products sold in Europe by Hewlett-Packard and its authorized dealers meet the specifications listed below.

Declaration of Conformity (according to ISO/IEC Guide 22 and EN 45014)

Manufacturer: Hewlett-Packard Company
Address: Hewlett-Packard Company
Mobile Computing Division
19310 Pruneridge Ave.
Cupertino, CA 95014
declares that the following product
Product name: HP OmniBook 3000, all models
Options: All
conforms to the following product specifications
Safety: IEC 950:1991+A1,A2 / EN 60950 (1992)+A1,A2
IEC 825-1:1993/EN60825-1:1994, Class 1
EMC: CISPR 22:1993 / EN 55022 (1994): Class B [1]
EN 50082-1:1992
IEC 801-2:1991 / prEN 55024-2 (1992): 4kV CD, 8kV AD
IEC 801-3:1984 / prEN 55024-3 (1991): 3V/m
IEC 801-4:1988 / prEN 55024-4 (1992): 0.5 kV signal lines, 1.0kV
power lines
Supplementary Information: The product herewith complies with the requirements of the Low
Voltage Directive 73/23/EEC and the EMC Directive 89/336/EEC.

The HP F1377A ac adapter used with this product is designed to
operate on all power systems, other than IT power systems.
[1] The product was tested in a typical configuration with
Hewlett-Packard personal computer peripherals.

Quality Department
Hewlett-Packard Company
Mobile Computing Division

Index

A

- ac adapter
 - charging battery, 4-5
 - connecting, 2-3, 4-5
 - status panel icon, 4-4
- address
 - AdLib synthesizer, 2-8
 - audio jacks, 5-17
 - base I/O address, 2-7
 - Hewlett-Packard, 9-2
 - HP website, 1-2
 - Input/Output, 9-6
 - MIDI, 2-8
 - Sound Blaster, 2-8
 - Windows Sound System, 2-8
- adjusting
 - brightness, 3-9
 - volume, 3-12
- AdLib synthesizer I/O address, 2-8
- Advanced Power Management (APM), 4-2
- anti-static devices, 6-6
- audio devices
 - configuring, 2-8
 - connecting, 5-17
 - drivers, 7-3, 7-4
 - mono plugs, 5-17
 - muting, 5-17
 - troubleshooting, 8-4
- auto adapter, 1-7

B

- base I/O address, 2-7
- battery
 - charging, 4-5
 - charging light, 1-6
 - defective, 4-4
 - installing main, 4-7
 - installing secondary, 4-8
 - low warning, 4-5
 - operating time, 4-6, 4-10
 - overheated, 4-4
 - safeguards, 4-2
 - safety, 4-7
 - saving power, 4-10
 - troubleshooting, 8-10
- BIOS
 - resources, 9-5
 - updating, 7-10
- brightness (adjusting), 3-9
- bulletin board service, 1-2

C

- cable
 - floppy (F1380A), 1-4
 - security lock, 3-19
- cards. *See* PC Cards
- CD-ROM drive
 - inserting CD, 5-6
 - opening manually, 5-7
 - parallel port CD-ROM drive, 7-5
 - PC Card, 7-5

- removing
 - CD, 5-6
 - safety, 5-6
- channels (DMA), 9-6
- charging
 - battery, 4-5
 - status, 4-6
- CHKDSK, 8-5
- cleaning the OmniBook, 9-2
- click buttons, 1-6
- clicking items, 3-7
- compatible PC Cards, 5-16
- configuring
 - audio devices, 9-5
 - MIDI devices, 2-8
 - OmniBook, 2-5
 - system resources, 9-5
 - TouchPad, 3-8
- connecting
 - ac adapter, 4-5
 - audio devices, 5-17
 - infrared, 5-21
 - keyboard, 5-10, 5-12
 - parallel device, 5-11
 - port replicator, 5-18
 - PS/2 mouse, 5-12
 - serial device, 5-12
 - serial mouse, 5-12
 - USB device, 5-13
- Corporate Evaluator's Guide, 1-2, 7-6
- corrupted files, 8-5
- creating
 - hibernate partition, 6-5
 - Support Utility Disk, 6-5

D

- daisy-chain connection, 5-13
- default values, 9-5
- devices
 - anti-static, 6-6

- audio, 5-17
- boot order, 2-10
- conflicts, 2-6
- connecting, 5-9
- drivers, 7-3, 7-4
- MIDI, 2-8
- parallel, 5-11
- serial, 5-12
- USB, 5-13
- video display, 2-6
- display
 - impact on operating time, 4-10
 - options, 5-10
 - quality statement, 3-10
 - resolution, 3-9
 - scrolling, 3-8
 - troubleshooting, 8-4
- DMA channels, 9-6
- dock. *See* port replicator
- dot matrix printer, 5-11
- dragging items, 3-7
- drivers
 - installing, 7-6
 - on Recovery CD, 7-6

E

- ECP, 5-11
- enabling
 - built-in keypad, 3-12
 - display device, 5-10
 - external keypad, 3-13
 - PS/2 device, 2-7
- EPP, 5-11
- ergonomics, 9-8
- external
 - connections, 5-9
 - display, 3-12
 - Fn key, 2-7
 - keyboard, 3-12
 - keypad, 3-13

video display device, 2-6

F

F1 through F12, 3-12
factory-installed operating system, 2-4
FAT32, 7-4
floppy disk drive
 cable (F1380A), 1-4
 inserting/removing disk, 5-5
 specifications, 1-5
 status panel icon, 3-15
 troubleshooting, 8-5
Fn key
 + DOWN-Arrow (volume), 3-12
 + F1 (decrease brightness), 3-9
 + F12 (hibernate), 3-12
 + F2 (increase brightness), 3-9
 + F5 (display options), 5-10
 + F6 (battery status), 3-12, 3-14
 + F8 (keypad), 3-13
 + F9 (Num Lock), 3-13
 + R (Suspend), 3-12
 + S (Standby), 3-12
 + UP-Arrow (increase volume), 8-4
 + UP-arrow (volume), 3-12
function keys, 3-12

H

hard disk drive
 hibernate partition, 6-5
 installing, 6-3
 removing, 6-2, 6-3
 security, 3-19
 troubleshooting, 8-5
hardware specifications, 9-3
hibernate
 mode, 3-4, 3-12
 partition, 6-5
hot keys, 3-12
HP applications, 7-9

I

infrared
 configuring port, 2-7
 light path, 8-7
 port (connecting), 5-21
 printing, 8-7
 troubleshooting, 8-7
InkJet printer, 5-11
inserting CD, 5-6
installing
 hard disk drive, 6-3
 HP software, 7-4
 operating systems, 7-4
 PC Cards, 5-14
 RAM, 6-6
 secondary battery, 4-8
 Windows 95 4.0 950 B, 7-8
 Windows for Workgroups, 7-4, 7-6
 Windows NT 4.0, 7-6
instant-on, 3-4
internal microphone, 1-6
internal speaker, 1-6
interrupts (system), 9-5

K

Kensington lock, 3-19
keyboard
 function keys, 3-12
 numeric keypad, 3-12
 troubleshooting, 8-6

L

laser printer, 5-11
laser safety, 5-6, 9-9
LED safety, 9-9
license agreement, iii
lights
 ac adapter, 2-3
 battery charge remaining, 3-16

- battery status, 3-16
- infrared, 8-7
- low battery
 - charging, 4-5
 - condition, 4-2
 - warning, 4-5

M

- main battery
 - installing, 4-7
 - location, 1-6
- memory. *See* RAM
- MicroSaver lock, 3-19
- MIDI devices
 - configuring, 2-8
 - I/O address, 2-8
 - with port replicator, 9-4
- mono plugs, 5-17
- mouse
 - enabling, 2-7
 - serial, 5-12, 8-6
 - troubleshooting, 8-6
 - Y-adapter, 8-6

O

- Off mode, 3-4
- Olicom
 - Token Ring + 33.6 Modem, 5-16
 - Token Ring Adapter C30 OC3221, 5-16
- OmniBook
 - accessories, 1-5
 - cleaning, 9-2
 - configuring, 2-5
 - docking, 5-18
 - features, 1-6
- OmniBook Notes, 1-2
- operating systems
 - Windows 95
 - recovering 4.0 950 B, 7-8

- Windows NT 4.0, 7-6
- Ositech
 - Ethernet Lan + 33.6 Modem, 5-16
 - Seven of Diamonds 10/100 Ethernet Adapter, 5-16

P

- parallel device
 - configuring port, 2-7
 - connecting, 5-11
 - troubleshooting, 8-13
- partition (hibernate), 6-5
- password
 - deleting, 3-18
 - setting, 3-17
 - system, 2-8
- PC Cards
 - CardBus 10/100 Ethernet Lan Adapter, 5-16
 - compatible, 5-16
 - Ethernet Lan + 33.6 Modem, 5-16
 - Ethernet Lan + 56K Modem, 5-16
 - Go Card Token Ring Adapter C30 OC3221, 5-16
 - inserting, 5-14
 - removing, 5-15
 - saving power, 4-10
 - Seven of Diamonds 10/100 Ethernet Adapter, 5-16
 - Token Ring + 33.6 Modem, 5-16
 - troubleshooting, 8-8
 - types, 5-14
- performance, 8-9
- plug requirements, 9-7
- pointing device. *See* TouchPad
- port replicator
 - MIDI port, 2-8
 - part number, 1-5
 - security, 3-19
 - troubleshooting, 8-3

- undocking, 5-20
- USB ports, 5-13
- power
 - Advanced Power Management, 4-2
 - connecting ac, 2-3, 4-5
 - conserving, 4-11
 - managing, 4-2
 - saving, 4-10
- power button
 - location, 1-6
 - suspending OmniBook, 3-3
- power cords, 9-7
- printing
 - compatible printers, 5-11
 - infrared, 8-7
 - parallel connection, 5-11
 - troubleshooting, 8-12
- product specifications, 9-2
- programming service, 7-9
- protection
 - password, 3-17
 - security cable, 3-19

R

- RAM
 - correct handling, 6-6
 - installing, 6-6
 - system resource, 9-6
 - troubleshooting, 8-8
- recharging battery, 4-5
- recovering Windows, 7-4
- Recovery CD
 - contents, 7-4
 - drivers, 7-6
 - programming service, 7-9
 - replacing, 7-10
- regulatory information, 9-10
- reinstalling
 - HP applications, 7-9
 - Windows 95 4.0 950 B, 7-8

- release latch, 4-7
- removing
 - hard disk drive, 6-2, 6-3
 - main battery, 4-7
 - PC Cards, 5-15
 - secondary battery, 4-8
- removing CD, 5-6
- replacing
 - hard drive, 6-3

S

- safety
 - CD-ROM, 5-6
 - ergonomics, 9-8
 - laser, 5-6, 9-9
 - latch, 4-7
 - LED, 9-9
 - power, 9-7
 - voltage, 9-7
- saving battery power, 4-10
- scrolling, 3-8
- security
 - hard disk drive, 3-19
 - RAM, 3-19
- security cable, 3-19
- selecting
 - items, 3-7
 - text, 3-7
- serial device
 - connecting, 5-12
 - conserving power, 4-10
 - troubleshooting, 8-13
 - USB, 5-13
- serial mouse, 5-12, 8-6
- service
 - booklet, 1-4
 - CD programming, 7-9
 - HP Bulletin Board, 1-2
 - HP service center, 9-9
- setting

- time-outs, 2-9
- setting passwords, 3-17
- shortcut keys, 3-12
- software
 - license, iii
 - resources, 9-5
- Sound Blaster:, 2-8
- speakers (internal), 1-6
- specifications, 9-2
 - hardware, 9-3
 - software system, 9-5
- Standby
 - automatic after 2 min., 3-3
 - mode, 3-4
 - setting time-out for, 2-9
- status panel
 - battery status indicators, 4-4
 - charge status, 4-6
 - location, 1-6
- support, 9-9
- Support Utility Disk, 6-5, 7-4
- Suspend
 - by closing lid, 3-3
 - mode, 3-4
 - password on resume, 2-8
 - setting time-out for, 2-9
 - with power button, 3-3
- system resources
 - DMA channels, 9-6
 - Input/Output addresses, 9-6
 - memory, 9-6
 - system interrupts, 9-5

T

- tapping items, 3-7
- time-out
 - defaults, 2-9
 - power savings, 3-4
 - setting, 4-11
- TouchPad

- configuring, 3-8
- customizing, 3-7
- dragging objects, 3-7
- enhancements, 3-8
- introduction, 3-6
- location, 1-6
- scrolling, 3-8
- settings, 3-8
- troubleshooting, 8-6
- tutorial, 3-8
- troubleshooting
 - audio devices, 8-4
 - CD-ROM drive, 8-3
 - display, 8-4
 - floppy disk drive, 8-5
 - hard disk drive, 8-5
 - infrared, 8-7
 - keyboard or mouse, 8-6
 - memory, 8-8
 - parallel device, 8-13
 - PC Cards, 8-8
 - performance, 8-9
 - power, 8-10
 - printing, 8-12
 - serial device, 8-13
 - startup, 8-14
 - TouchPad, 8-6
 - Zip drive, 8-3
- turning off OmniBook
 - methods, 3-3
 - reset, 3-5
 - time-outs, 3-4

U

- Universal Serial Bus (USB)
 - connecting, 5-13
 - daisy-chain connection, 5-13
- User's Handbook (online)
 - in OmniBook Library group, 1-2

V

virtual scroll bar, 3-8
virus scan, 8-5
voltage requirements, 9-7

W

warning (low battery), 4-5
website, 1-2
Windows 95
 Companion CD, 1-4
 compatible PC Cards, 5-16
 documentation, 1-2
 license agreement, 2-4
 setting up, 2-3
 version 4.0 950 B, 7-8
Windows NT 4.0, 7-6
 compatible PC Cards, 5-16
 installing drivers, 7-3
 support, 9-4

Windows Sound System, 2-8
Working in Comfort, 9-8

X

Xircom
 CardBus 10/100 Ethernet Lan
 Adapter, 5-16
 Ethernet Lan + 56K Modem, 5-16

Y

Y-adaptor, 8-6

Z

Zip drive
 ejecting, 5-8
 inserting, 5-8
 installing drivers, 5-7
zoomed video, 3-9, 5-14, 9-3