

# USER'S GUIDE

**PC-8300**



3/25/96 PC8300 CLK = -21 sec.

## FOR USERS OUTSIDE THE UNITED STATES

" Batt = 2860 -

**Please read this sheet before you read the User's Guide or TELCOM Manual. In countries other than the United States, the following items are different from those mentioned in the manuals.**

1. The optional 300 baud Modem Card PC-8361A (in User's Guide Chapter 1, 6, Section 6.3, Appendix A, B, and E; and TELCOM Manual) is not available in countries other than the U.S.
2. The PHONE port on the rear of the PC-8300 (explained in the User's Guide Section 2.2, 6.3, Appendix B, and TELCOM Manual) is used when the optional 300 baud Modem Card is installed in the PC-8300, so without the Modem Card, this port has no function.
3. The optional CFT Adapter PC-8241A-K (introduced in the User's Guide Chapter 1, and Section 6.6) is not available in countries other than the U.S.
4. Some recommended printers in Appendix E are not available in countries other than the U.S. Contact the shop where you purchased your PC-8300 for information on compatible printers.
5. AC outlet power varies by country. The following are the recommendable AC Adapters for the PC-8300 provided from NEC.  
For 120 V AC outlet: AC Adapter PC-8271A-01  
For 220 V AC outlet: AC Adapter PC-82713-01
6. Some other accessories in User's Guide Appendix E are not available in countries other than the U.S. Contact the shop where you purchased your PC-8300 for information on compatible accessories.
7. Please ignore the warranty cards and the customer questionnaire provided from NEC Home Electronics (U.S.A.) (introduced in the User's Guide Section 1.2). They are only for users in the U.S. The Business Reply Mail system is usable only in the U.S. as well.
8. The tutorial section of the TELCOM Manual uses MCI Mail as an example of how to access a database service. But for some countries other than the U.S., this database service is not available or is using different procedures. Refer to the information provided from the database service available in your country.

**This sheet is not necessary for U.S. users, who can tear this page out.**

## ITEMS TO BE DELIVERED

The following items will be packed and delivered to you.

Description	Quantity
1. PC-8300 Portable Computer	1
2. PC-8300 User's Guide	1
3. PC-8300 TELCOM Manual	1
4. PC-8300 TEXT Manual	1
5. PC-8300 Personal Application Kit Guide	1
6. PC-8300 N82-BASIC Reference Manual	1
7. PC-8300 N82-BASIC Reference Card	1
8. PC-8300 Limited Warranty	1
9. PC-8300 Extended Warranty	1
10. PC-8300 Customer Questionnaire	1
11. PC-8300 Personal Application Kit	1
12. CMT Cable (PC-8493A)	1

If you should find any item missing, contact your nearest sales office or shop where you bought the product.

78118322

# **NEC**

# **PC-8300**

# **USER'S GUIDE**

©1986 NEC Home Electronics (U.S.A.), Inc.  
NEC Corporation

All rights reserved. No part of this publication may be reproduced in whole or in part without the prior written permission of NEC Home Electronics (U.S.A.) Inc., and NEC Corporation.

The policy of NEC being that of continuous product improvement, the contents of this manual are subject to change, without notice.

All efforts have been made to ensure that the contents of this manual are correct; however, should any errors be detected, NEC would greatly appreciate being informed.

NEC can assume no responsibility for errors in this manual, or their consequences.

## NOTICE

This equipment generates and uses radio frequency energy, and if not installed and used properly, that is, in strict accordance with the manufacturer's instructions, may cause interference to radio and television reception.

It has been type tested and found to comply with Part 68 and the limits for a Class B computing device in accordance with the specifications in Subpart J of Part 15 of FCC Rules, which are designed to provide reasonable protection against such interference in a residential installation.

If the equipment does cause interference to radio and television reception, which can be determined by turning the the equipment off and on, the user is encouraged to try to correct the interference by one or more of the following measures:

- reorient the receiving antenna
- relocate the computer with respect to the receiver
- move the computer away from the receiver
- plug the computer into a different outlet so that the computer and the receiver are on different branch circuits

If necessary, the user should consult the dealer or an experienced radio/television technician for additional suggestions. The user may find the following booklet prepared by the Federal Communications Commission helpful:

"How to Identify and Resolve Radio-TV Interference Problems". This booklet is available from the US Government Printing Office, Washington, D.C., 20402.

## WARNING

This equipment has been certified to comply with Part 68 and the limits for a Class B computing device, pursuant to Subpart J of Part 15 of FCC Rules.

Only peripherals (computer input/output devices, terminals, printers etc.) certified to comply with the Class B limits may be attached to this computer.

Operation with non-certified peripherals is likely to result in interference to radio and TV reception.

## INTERCONNECTING CABLES

Optional dedicated cartridges are connected by inserting them into the "system slot" on the CPU.

The following cables were used in the tests:

- A shielded CMT cable (PC-8493A),
- A shielded reverse RS-232C computer-cable (PC-8495A-02),
- A shielded straight RS-232C modem cable (PC-8495A-01),
- A shielded printer cable (PC-8494A),
- An unshielded FDD cable (PC8298),
- A shielded CRT cable (PC-8292A), and
- An unshielded phone cable (PC-8399A-02)

The central office line was connected via a phone cable (PC-8399A-02)

The CRT cable had two ferrite toroids installed, one on each end.

The RS-232C cables, the printer cable, and the CMT cable each had one ferrite toroid installed on the end which connects to the CPU.

The FDD cable had one ferrite toroid installed on the end which connects to the FDD.

Operation without the cables described above could violate the FCC rules and regulations.

## FCC REQUIREMENTS

### TYPE OF SERVICE

Your PC-8300 is designed to be used on standard device telephone lines. Connection to a coin-service telephone (central office implemented systems) provided by a telephone company is prohibited. Connection to party lines service is subject to state tariffs.

### TELEPHONE COMPANY PROCEDURE

The goal of the telephone company is to provide you with the best possible service. In order for them to do this, it may occasionally be necessary for them to make changes to their equipment, operations, or procedures. If these changes might affect your service or the operation of your equipment, the telephone company will give you notice, in writing, to allow you to make any necessary changes to maintain uninterrupted service.

If you have any questions about your telephone line, such as how many pieces of equipment you can connect to it, the telephone company will provide this information upon request.

In certain circumstances it may be necessary for the telephone company to request information from you concerning the equipment which you have connected to your telephone line. Upon the telephone company's request, please provide the FCC registration number and the ringer equivalence number (REN) of the equipment which is connected to your line; both of these items are listed on the equipment label. The sum of all the RENs on your telephone lines should be less than five in order to assure proper service from the telephone company. In some cases, even a sum of five may not be used on a given line.

### IF PROBLEMS ARISE

If any of your telephone equipment is not operating properly, you should immediately remove it from your telephone line as it may cause harm to the telephone network. If the telephone company notes a problem, they may temporarily discontinue service. When practical, they will notify you in advance of such disconnection. If advance notice is not feasible, you will be notified as soon as possible. When you are notified, you will be given the opportunity to correct the problem, and you will be informed of your right to file a complaint with the FCC.

If your PC-8300 needs repair, it should be performed by NEC Home Electronics U.S.A. Inc., or by an authorized representative of NEC Home Electronics U.S.A. Inc.

For more information, please contact:

NEC Home Electronics U.S.A. Inc.  
1255 Michael Drive  
Wood Dale, Illinois 60191-1094

# PREFACE

The PC-8300 is a unique and practical computer. It is compact enough to be carried in a briefcase and yet it offers many features of a large computer. It is portable and can be used anywhere.

The latest technology has been used in the development of the PC-8300, as seen in the Complementary Metal Oxide Semiconductor (CMOS), Read Only Memory (ROM), and Random Access Memory (RAM).

CMOS is a state-of-the-art semiconductor technology used in battery operated systems, since it offers low power and low voltage operation. ROM is used to store the programs that operate the PC-8300. ROM cannot be "written into" or altered in any way, and it is not erased when the power to the PC-8300 is turned off. RAM is the type of memory that can be altered. Information can be "written in" or "read out" very quickly. This memory is "saved" in the PC-8300 as long as the battery power remains adequate, or an electrical power source is connected to the unit.

The PC-8300's RAM is expandable to 192K bytes through the use of external RAM Cartridges. The PC-8300 has a large Liquid Crystal Display (LCD) which can display 8 lines of text containing 40 characters each.

The PC-8300 has a full-size keyboard with a variety of special function keys. It offers the convenience of operating the machine with battery power anywhere. An AC Adapter is available for use with 120 volt AC power, so that the NiCd Battery Cartridge (PC-8307A-90 or PC-8207A-90) can be recharged, and the charge of standard batteries can be conserved.

Built-in software features include Microsoft<sup>TM</sup>'s N82-BASIC programming language, wordprocessing, and telecommunications. Hardware features built into the PC-8300 include automatic power shut-off, a "real-time" clock, and a sound generator.

Interfaces allow the PC-8300 to communicate with various external devices such as printers, data recorders, disk drive units, bar code readers, telephones, etc.

The PC-8300 is intended for all people, from the computer novice to professionals. Anywhere there is a need for portable computing power, such as at school, work, or while traveling, the PC-8300 is the logical choice.

# DO'S AND DON'T'S



- Do read the User's Guide thoroughly. Notice the precautions, special references, and special notes in the manual, for best performance of the PC-8300.

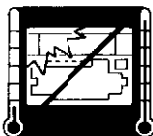

- Don't expose the PC-8300 to extreme temperatures. Extreme cold could freeze the LCD display, causing permanent damage.



- Don't leave the PC-8300 or peripheral devices in direct sunlight.

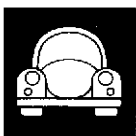

- Don't leave your PC-8300 in a car unattended for long periods, since temperatures are not controlled in a parked automobile.



- Don't leave the PC-8300 in the luggage compartment of a train, bus, or airplane, since temperatures are not controlled in those areas.
- Don't allow the PC-8300 to pass through airport X-ray scanning equipment.



- Don't put pressure on the LCD screen. Excessive pressure could cause permanent damage to the display.
- Don't use harsh detergents or cleaning solutions on the PC-8300. Clean only with a slightly damp cloth.
- Do keep connection ports on the back of the PC-8300 covered with the plastic covers provided when not in use. Pins and connectors could easily be damaged if left uncovered.



# TABLE OF CONTENTS

---

## CHAPTER 1 OUTLINE

<b>1.1 HOW TO USE THIS MANUAL</b> .....	2
<b>1.2 UNPACKING YOUR PC-8300</b> .....	4
1.2.1 Description of the PC-8300 Manuals .....	5
<b>1.3 STANDARD FEATURES OF THE PC-8300</b> .....	6
1.3.1 Description of the Computer and Its Parts .....	6
<b>1.4 OPTIONAL FEATURES OF THE PC-8300</b> .....	7
1.4.1 Family of Components .....	8

## CHAPTER 2 GETTING UP AND RUNNING

<b>2.1 MEETING YOUR PC-8300</b> .....	14
<b>2.2 MAIN POWER SUPPLY OPTIONS</b> .....	18
2.2.1 AA Batteries .....	18
2.2.2 AC Adapter .....	22
2.2.3 NiCd (Nickel-cadmium) Battery Cartridge .....	23
<b>2.3 BACK-UP POWER</b> .....	24
<b>2.4 TURNING THE POWER ON AND OFF</b> .....	25
2.4.1 Turning the Power On .....	25
2.4.2 Turning the Power Off .....	26
2.4.3 Automatic Shut Off .....	27
<b>2.5 LOW BATTERY LED</b> .....	27
<b>2.6 USING THE PC-8300 KEYBOARD'S SPECIAL KEYS</b> .....	28

## **CHAPTER 3      INFORMATION ABOUT THE MEMORY**

<b>3.1 MEMORY CAPACITY .....</b>	<b>34</b>
<b>3.2 WARM START AND COLD START .....</b>	<b>35</b>
3.2.1 Back-up Power .....	35
3.2.2 When and How to Use a Warm Start and a Cold Start .....	36
3.2.3 Turning the PC-8300 on by a Warm Start .....	36
3.2.4 Initializing the PC-8300 RAM with a Cold Start ...	37
<b>3.3 MEMORY PROTECTION .....</b>	<b>39</b>
<b>3.4 RESET SWITCH .....</b>	<b>41</b>

## **CHAPTER 4      UNDERSTANDING THE MENU**

<b>4.1 LOOKING AT THE MENU .....</b>	<b>47</b>
<b>4.2 INTRODUCING THE BUILT-IN SOFTWARE .....</b>	<b>48</b>
<b>4.3 FILES .....</b>	<b>50</b>
<b>4.4 SETTING TIME AND DATE .....</b>	<b>52</b>
<b>4.5 STARTING A PROGRAM .....</b>	<b>55</b>
4.5.1 Starting a Built-in Program .....	55
4.5.2 Starting and Automatically Opening a Document File .....	56
4.5.3 Executing a Program from the MENU .....	57
<b>4.6 EXITING TO THE MENU MODE .....</b>	<b>57</b>

## CHAPTER 5 MENU COMMANDS

<b>5.1 LOAD</b> <b>f.1</b> .....	61
5.1.1 Device Name and File Name .....	63
(Response to the "Load from" Prompt)	
5.1.2 File-type Extensions .....	64
<b>5.2 SAVE</b> <b>f.2</b> .....	65
5.2.1 Device Name and File Name (to the "Save Filename as" Prompt) .....	67
<b>5.3 NAME</b> <b>f.3</b> .....	69
<b>5.4 LIST</b> <b>f.4</b> .....	70
<b>5.5 SETIPL</b> <b>f.6</b> .....	72
<b>5.6 CLR IPL</b> <b>f.7</b> .....	74
<b>5.7 KILL</b> <b>f.9</b> .....	75
<b>5.8 BANK</b> <b>f.10</b> .....	76

## CHAPTER 6 PERIPHERAL DEVICES

<b>6.1 DATA RECORDER</b> .....	81
6.1.1 Connecting the Data Recorder PC-8281A .....	82
6.1.2 Preparing Cassette Tape and Data Recorder ...	83
6.1.3 Care and Handling of Cassette Tapes .....	84
6.1.4 Maintaining the PC-8281A Data Recorder .....	86
6.1.5 Troubleshooting .....	87
<b>6.2 PRINTER</b> .....	87
6.2.1 Connecting a Printer .....	88
6.2.2 Preparing a Printer .....	89
6.2.3 Printing out Your Data and Files .....	89
6.2.4 Printer Maintenance .....	90
6.2.5 Troubleshooting .....	91
<b>6.3 DEVICES FOR TELECOMMUNICATIONS</b> .....	93
6.3.1 Purpose of Telecommunications .....	93
6.3.2 Connecting the Optional Modem Card .....	93
6.3.3 Using the RS-232C Serial Port .....	96
6.3.4 Operating with an External Modem .....	99
6.3.5 Troubleshooting .....	100

<b>6.4 RAM CARTRIDGE</b> .....	102
6.4.1 Connecting and Disconnecting the RAM Cartridges .....	102
6.4.2 Power Supply for the RAM Cartridge .....	105
6.4.3 Operating the RAM Cartridges .....	105
6.4.4 Memory Protection .....	106
6.4.5 Battery Information .....	107
6.4.6 Troubleshooting .....	109
<b>6.5 DISK DRIVE</b> .....	109
6.5.1 Introducing the PC-8231A Micro Disk Unit and the Micro Floppy Disk .....	110
6.5.2 The Micro Floppy Disk .....	112
6.5.3 Connecting the Disk Unit .....	113
6.5.4 Operating the PC-8231A Micro Disk Unit .....	115
6.5.5 Booting the Disk Code .....	118
6.5.6 Operating the PC-8300 MENU with the Disk Unit .....	119
6.5.7 Operating N82-BASIC with the Disk Unit .....	121
6.5.8 Care and Handling of Micro Floppy Disks .....	122
6.5.9 Maintaining the Micro Disk Unit .....	124
6.5.10 Troubleshooting .....	125
<b>6.6 OTHER PERIPHERAL DEVICES</b> .....	126

## APPENDICES

<b>A. HARDWARE SPECIFICATIONS</b> .....	130
<b>B. I/O INTERFACE</b> .....	135
<b>C. MEMORY MAP</b> .....	141
<b>D. CHARACTER CODES</b> .....	143
<b>E. OPTIONAL ACCESSORIES</b> .....	144
<b>F. SWITCHING THE CHARACTER SET</b> .....	147
<b>G. SWITCHING TO THE PC-8201A MODE</b> .....	151
<b>H. GLOSSARY</b> .....	153
<b>I. LIST OF NEC SERVICE OFFICES</b> .....	155

<b>INDEX</b> .....	157
--------------------	-----

# CHAPTER 1

## OUTLINE

---

<b>1.1 HOW TO USE THIS MANUAL .....</b>	<b>2</b>
<b>1.2 UNPACKING YOUR PC-8300 .....</b>	<b>4</b>
1.2.1 Description of the PC-8300 Manuals .....	5
<b>1.3 STANDARD FEATURES OF THE PC-8300 .....</b>	<b>6</b>
1.3.1 Description of the Computer and Its Parts .....	6
<b>1.4 OPTIONAL FEATURES OF THE PC-8300 .....</b>	<b>7</b>
1.4.1 Family of Components .....	8



## **1.1 HOW TO USE THIS MANUAL**

Welcome to the world of portability and convenience! As a new owner of an NEC PC-8300 portable personal computer, you've just embarked on a journey that will take you to new heights of productivity and efficiency.

The PC-8300 comes equipped with three productivity software packages built in. 3.44 pound (1.56 kg) battery-operated package includes programming, word processing, and telecommunications tools. Now you can truly take your office with you.

This User's Guide is the map for your journey into the world of the PC-8300.

Read this manual immediately after you unpack your PC-8300 from its box. You'll find that it's arranged in a manner suitable for you, whether you're a first-time user or an experienced operator.

Chapter 1 through 5 include instructions on the basic operations of the PC-8300 for all users.

Chapter 6 describes the use of the PC-8300 with optional peripherals.

The Appendices contains technical information of interest to experienced users.

## Signs and Symbols

The following signs, symbols, and warnings will be found throughout the PC-8300 User's Guide.



"CAUTION"



"REMEMBER"



**BOLD FACE CAPS** Type in the command or text exactly as written.



Press the return key when you see this.

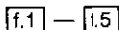

Press the function keys when you see this.

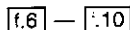

Press **SHIFT** and **f.1** — **f.5** function keys simultaneously when you see these.

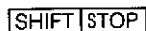

These are examples of cases when two keys must be pressed simultaneously. Normally you hold the first key down while pressing the second key. **SHIFT**, **CTRL**, and **GRAPH** are always used with other character keys, since they never work alone. In the first example above, hold down **SHIFT** and press **STOP**.

space bar

The longest key with no label, on the bottom of the PC-8300 keyboard, is called the space bar.

## 1.2 UNPACKING YOUR PC-8300

Opening the package is the first exciting step toward using the PC-8300. Refer to the diagram below to be sure your PC-8300 package includes all the manuals, accessory cables and other items in this picture. Save the original box in case you have to ship or transport the PC-8300.

Besides the PC-8300 portable personal computer, the package should contain these items:

**Two Warranty Cards:** Please take a few minutes to fill out the warranty cards to insure that your PC-8300 is properly registered with NEC.

**CMT Cable (PC-8493A):** Connects the PC-8300 to a data recorder

**Personal Application Kit:** A cassette tape with business application programs, utilities, and games.

**A questionnaire from NEC Home Electronics, (U.S.A.) Inc.:** Please fill out this questionnaire and return it to us at your earliest convenience.

**Six Manuals:** PC-8300 User's Guide, PC-8300 TEXT Manual, PC-8300 TELCOM Manual, PC-8300 Personal Application Kit Guide, N82-BASIC Reference Manual, and N82-BASIC Reference Card. (Please see the next section for a more complete description of each of the above-mentioned manuals.)

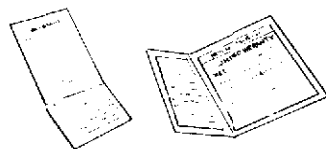

Warranty Cards

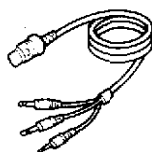

CMT Cable



Personal Application Kit:



Questionnaire

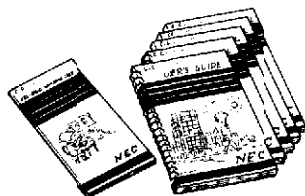

Manuals



## 1.2.1 Description of the PC-8300 Manuals

Included in the PC-8300 box are six manuals designed to help you utilize the PC-8300 to its fullest potential.



### **PC-8300 User's Guide**

The User's Guide includes information on using the PC-8300. It describes all the procedures from turning ON the power supply to operating the built-in software programs. Every user should read the PC-8300 User's Guide. Also included are instructions for operating the optional peripherals.

### **PC-8300 TEXT Manual**

The TEXT Manual describes the operation of the built-in word processing program called TEXT.

### **PC-8300 TELCOM Manual**

This manual describes the operation of the convenient, built-in telecommunications utility program called TELCOM.

### **PC-8300 Personal Application Kit Guide**

This guide explains how to use the programs in the Personal Application Kit (cassette tape included with your PC-8300). With the help of this guide, the application programs will be very useful to you.

### **N82-BASIC Reference Manual**

This manual gives detailed explanations of the built-in programming language in the PC-8300 ROM. The manual describes all commands and instructions of N82-BASIC in alphabetical order, and also contains sample programs.

### **N82-BASIC Reference Card**

This card was prepared specifically for use by experienced N82-BASIC programmers. A quick syntax format and useful tables are included.

## **1.3 STANDARD FEATURES OF THE PC-8300**

The PC-8300 offers true portability in a small package just the size of a small notebook.

The PC-8300 contains 64K RAM and 128K ROM. It is an 8085 compatible, CMOS-based, microcomputer that features low requirements for power and voltage. It operates with AA size batteries, externally recharged NiCd batteries or with AC Adapter (PC-8271A-01).

Enhancing the true portability of the PC-8300 are the two powerful built-in application programs called TEXT and TELCOM, a built-in programming language called BASIC, and a built-in operating system called MENU.

The MENU commands are menu driven from the large 40 column by 8 line LCD and are easy to use and understand.

TEXT is a very powerful and versatile built-in word processing program.

TELCOM is the built-in telecommunications utility program that uses the built-in RS-232C serial interface, the optional 300 baud Modem Card, or any other telecommunications devices, such as modems and acoustic couplers.

BASIC (Beginners' All-purpose Symbolic Instruction Code) is a programming language for beginning, intermediate and advanced computer programmers.

If you are not already familiar with BASIC, you will soon learn how easy it is to write programs to suit your own needs.

The PC-8300 by itself is a complete data processing unit, and with the addition of a few peripherals it can become a full performance desktop productivity tool.

### **1.3.1 Description of the Computer and Its Parts**

The PC-8300 is a computer for people on the go. Its light-weight, small size, self-contained power supply, built-in programs, and built-in programming language provide true portability and complete data processing capabilities.

The most visually apparent feature of the PC-8300 is the large display screen. The 40 column by 8 line LCD adjusts for optimum contrast and provides a large, easy-to-read viewing area. The comfortable keyboard features large keys and is arranged in the familiar electric-typewriter format. Five function keys provide ten functions, with the extra five accessed by holding **SHIFT**. The cursor keys are arranged in a logical cluster to provide easy cursor positioning on the screen.

An 8-bit, 8085 compatible CMOS CPU handles processing. The standard available RAM is 64K bytes expandable to 192K with the optional 128K RAM Cartridge (PC-8207A). The RAM Cartridge acts as a file storage device.

The PC-8300 interfaces include the system slot for use with the 32K/128K byte RAM Cartridges, or the CRT Adapter (PC-8241A-K). The RS-232C serial interface is used for data communications with other computers connected directly or through an external modem. The transmission rate is adjustable from 75 to 19200 baud. A Centronics-compatible parallel interface allows connection to a printer. The LINE and PHONE ports are used to install the optional Modem Card (PC-8361A) to the PC-8300. The data recorder is interfaced through the CMT (Cassette Magnetic Tape) port with a transmission rate of 600 baud. To save on batteries, an AC Adapter socket is provided for use with the optional AC Adapter (PC-8271A-01).

## 1.4 OPTIONAL FEATURES OF THE PC-8300

Although the PC-8300 is a full performance, productivity tool, its flexible design and family of peripherals allow it to perform as a normal desktop unit.

A larger display screen for easier viewing is possible when the CRT Adapter is used with a monochrome composite monitor.

The Micro Disk Unit (PC-8231A-K) is AC powered with one single-sided, double-density disk drive, which has a capacity of 320K. The Micro Disk Unit is connected to the PC-8300 by a special cable with modular connectors on each end, included in the unit.

The 32K and 128K RAM Cartridges (PC-8406A, and PC-8207A) are inserted into the system slot. They are battery-powered storage devices that act as rapid-access disk drives.

Additional peripherals and related items (cables, adapters etc.) for the PC-8300 are listed in the next section.

The PC-8300 is compatible also with all peripherals of the PC-8200 series.

### **1.4.1 Family of Components**

#### **PC-8300 Portable Computer**

Portable battery operated computer featuring a 40 column by 8 line LCD, two built-in (ROM) application programs, a BASIC language interpreter and a built-in operating system (MENU).

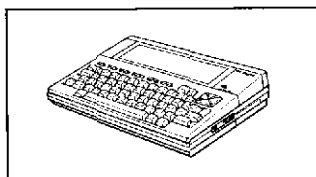

#### **PC-8241A-K CRT Adapter**

Adapter unit for interfacing the PC-8300 with a monochrome composite monitor.

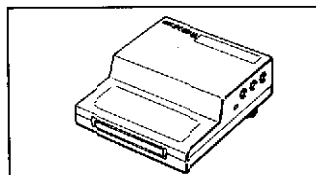

#### **PC-8231A-K Micro Disk Unit**

Disk Unit featuring a single 3 1/2inch, single-sided, double density, 320K capacity drive. AC powered.

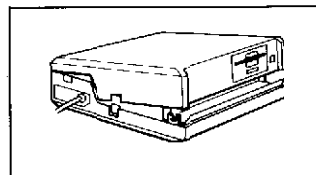

#### **PC-8361A Modem Card**

When this 300 baud Modem Card is installed into the bottom of the PC-8300, the ROM-resident telecommunications software TELCOM can communicate through it.

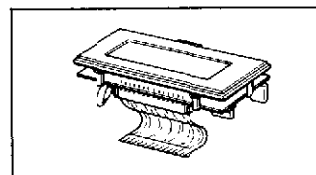

**PC-8207A RAM Cartridge (32K×4)**

Battery-powered 128K RAM Cartridge, for data storage (divided into four banks of 32K bytes each). The PC-8300 can access only one of the four banks at a time. You can select a bank by setting the BLOCK switch on the side of the cartridge.

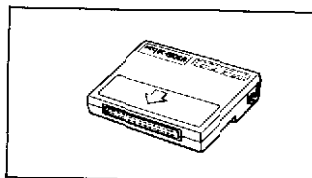
**PC-8206A 32K RAM Cartridge**

Similar to the PC-8207A, except that it has only one 32K byte memory bank.

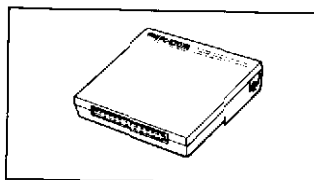
**PC-8281A Data Recorder**

Battery operated portable data recorder with some very convenient functions for use with your PC-8300.

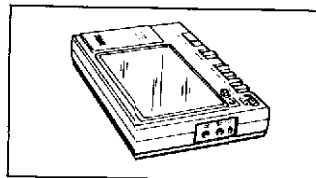
**PC-8271A-01 AC Adapter**

For use with the PC-8300 Portable Computer.

It will help you to save on batteries.

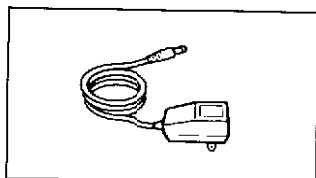
**PC-8201A-90 or PC-8301A-90****NiCd Battery Cartridge**

Exclusive Nickel-Cadmium Battery Cartridge. Recharged by installing it in the PC-8300 and using the AC Adapter.

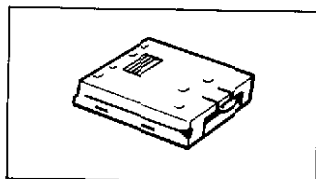

**PC-8495A-01 RS-232C Cable (normal)**

Normal (straight) RS-232C cable for data communications through an external modem.

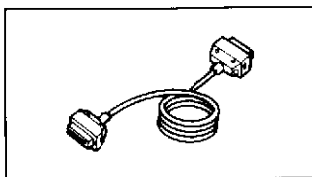

**PC-8495A-02 RS-232C Cable (reverse)**

Reverse RS-232C cable for direct computer-to-computer data communications.

**Not for use with a modem.**

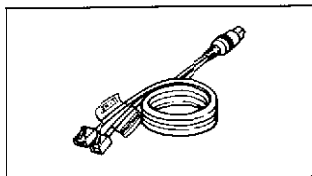

**PC-8399A-02 Phone Cable**

Used to connect a telephone set to the optional Modem Card (PC-8361A) installed in the PC-8300. Included with the PC-8361A.

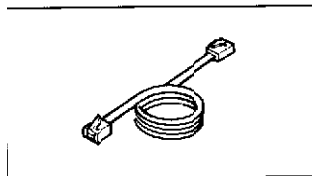

**PC-8494A Printer Cable**

Centronics compatible parallel printer cable to connect the PC-8300 to a parallel printer.

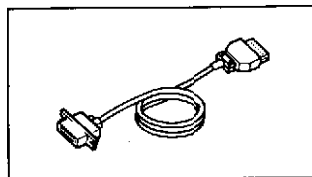

**PC-8493A CMT Cable**

Interface cable to connect the PC-8300 to a data recorder. Included with the PC-8300.

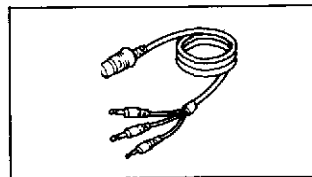

**PC-8298A FDD Cable**

Interface cable to connect the PC-8300 to a Micro Disk Unit (PC-8231A-K). Included in the Disk Unit box.

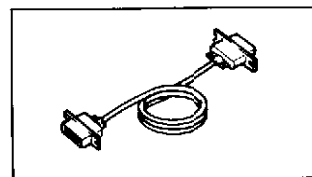

## Caution Regarding the Use of Cables

Optional dedicated cartridges are connected by inserting them into the system slot on the PC-8300.

The following cables were used in the tests:

- A shielded CMT Cable (PC-8493A),
- A shielded RS-232C Cable (normal) (PC-8495A-01),
- A shielded RS-232 Cable (reverse) (PC-8495A-02),
- A shielded Printer Cable (PC-8494A),
- An unshielded FDD Cable (PC8298A),
- A shielded CRT Cable (PC-8292A), and
- An unshielded Phone Cable (PC-8399A-02)

The central office line was connected via a phone cable (PC-8399A-02).

The CRT Cable had two ferrite toroids installed, one on each end.

The RS-232C Cables, the Printer Cable, and the CMT Cable each had one ferrite toroid installed on the end which connects to the PC-8300.

The FDD cable had one ferrite toroid installed on the end which connects to the FDD.

Operation without the cables described above could violate the FCC rules and regulations.

# CHAPTER 2

## GETTING UP AND RUNNING

---

<b>2.1 MEETING YOUR PC-8300</b> .....	14
<b>2.2 MAIN POWER SUPPLY OPTIONS</b> .....	18
22.1 AA Batteries .....	18
22.2 AC Adapter .....	22
22.3 NiCd (Nickel-cadmium) Battery Cartridge .....	23
<b>2.3 BACK-UP POWER</b> .....	24
<b>2.4 TURNING THE POWER ON AND OFF</b> .....	25
24.1 Turning the Power On .....	25
24.2 Turning the Power Off .....	26
24.3 Automatic Shut Off .....	27
<b>2.5 LOW BATTERY LED</b> .....	27
<b>2.6 USING THE PC-8300 KEYBOARD'S     SPECIAL KEYS</b> .....	28





Now that you have all the pieces of the PC-8300, it's time to get the computer "up and running".

This chapter introduces the PC-8300, its special hardware features and its keyboard.

This chapter also includes information on the power sources for the PC-8300 and shows you how to turn on the power.

## **2.1 MEETING YOUR PC-8300**

The next step you should take is simply to look at the various parts of the PC-8300, as shown:

## The Front and Right Side

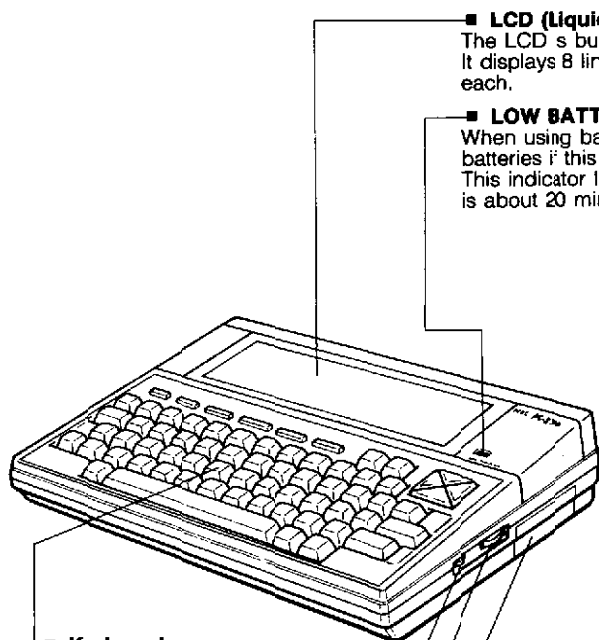

■ **LCD (Liquid Crystal Display)**

The LCD is built into the PC-8300. It displays 8 lines of 40 characters each.

■ **LOW BATTERY LED**

When using battery power, replace batteries if this indicator lights up. This indicator lights up when there is about 20 minutes of power left.

■ **Keyboard**

The keyboard of the PC-8300 has ordinary keys like on any typewriter, and also special keys. When an ordinary key is pressed, its symbol will appear on the screen, but when a special key is used, the corresponding command or special function is performed.

Some keys show two symbols on their key tops; when, while holding down **[SHIFT]**, a key is pressed, the character or function which appears on the top half of its key top will result.

Of course, when a letter key (a — z) is pressed while **[SHIFT]** is being held down, that letter will appear as a capital or upper case letter.

When locked down, the **[CAPS LOCK]** key will cause all the letters of the alphabet to appear as upper case letters.

■ **Battery pack**

The battery pack will hold four AA (1.5 volt) batteries. An optional Battery Cartridges containing NiCd (nickel-cadmium) batteries (PC-8301A-90 or PC-8201A-90) may be used in place of the regular battery pack.

■ **CONTRAST control**

This control adjusts the contrast of the LCD for optimal viewing.

■ **POWER switch**

This switch simply turns the power to the PC-8300 on or off.

## The Back

### ■ DC 8.5V\*

Connect the optional AC Adapter (PC-8271A-01) here to plug the PC-8300 into a wall outlet.

### ■ PROTECT switch

This switch prevents data from being entered into bank #2 if the memory has been expanded to include extra banks. The data within this bank is then protected from accidental loss.

### ■ RESET switch

The RESET switch is used to perform a "cold start", or as part of a process to free the computer when "hung up". This switch should only be used as a last resort, since the contents of the memory of the PC-8300 may be erased.

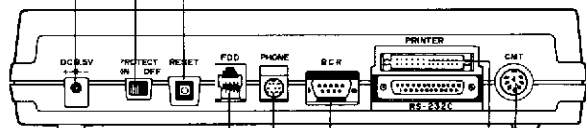

### ■ CMT port\*

Connect a data recorder to the PC-8300 here using the PC-8493A data recorder connection cable (included in the PC-8300 box).

### ■ PRINTER port\*

Connect parallel centronics interface printers to the PC-8300 here with the PC-8494A parallel printer cable.

### ■ RS-232C port\*

Connect a serial printer, an external modem or a cable to directly connect to another computer here.

### ■ BCR port\*

Connect a Bar Code Reader to the PC-8300 here.

### ■ PHONE port\*

With the branched Phone Cable (included in the optional Modem Card box), the PC-8300 is connected to your telephone system.

### ■ FDD port\*

Connect the Micro Disk Unit (PC-8231A-K) here using the modular jack cable (included in the PC-8231A-K box).

A protective cap has been fitted on these connectors. Before connecting a peripheral, remove the cap, save it, and put it back over the connector when the peripheral is disconnected.

## The Bottom

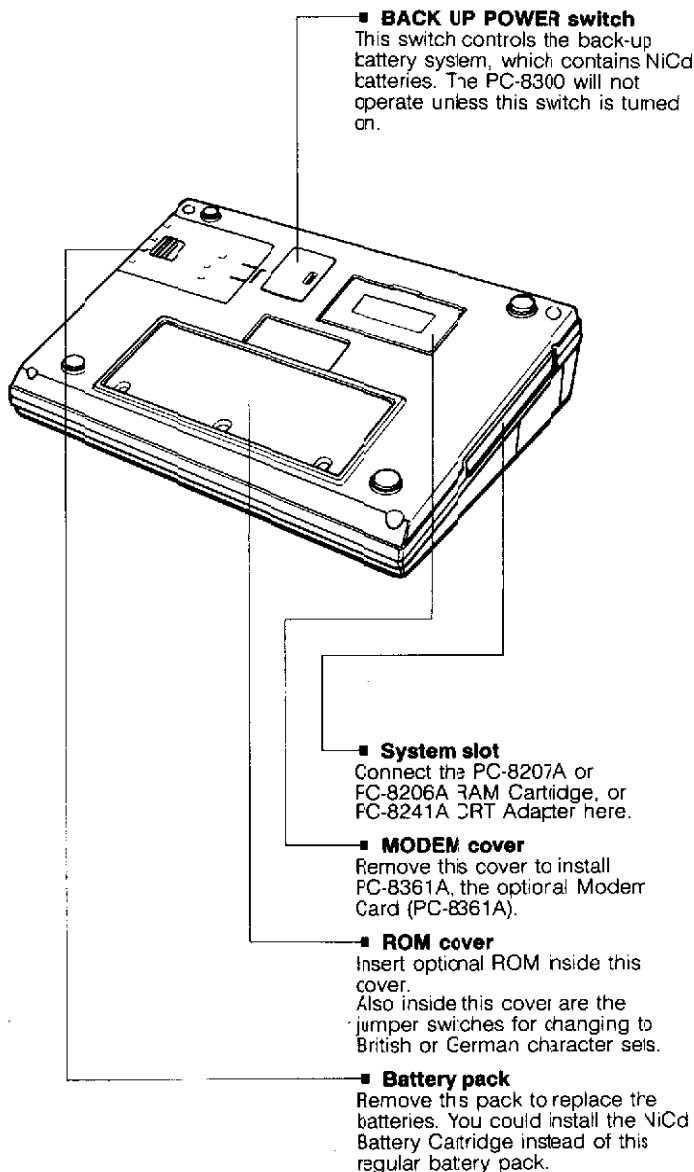

## 2.2 MAIN POWER SUPPLY OPTIONS

The PC-8300 has three main power source options:

- AA batteries,
- an optional AC Adapter, and
- a rechargeable NiCd Battery Cartridge.

This section describes how to install these three power sources.

### 2.2.1 AA Batteries

The PC-8300 can operate on four standard or alkaline AA batteries installed in the regular battery pack.



NiCd AA batteries can't be used in the regular battery pack. When you use NiCd batteries, the optional NiCd Battery Cartridge is necessary.

To install AA batteries, follow these steps.

1. Turn the POWER switch to the OFF position:

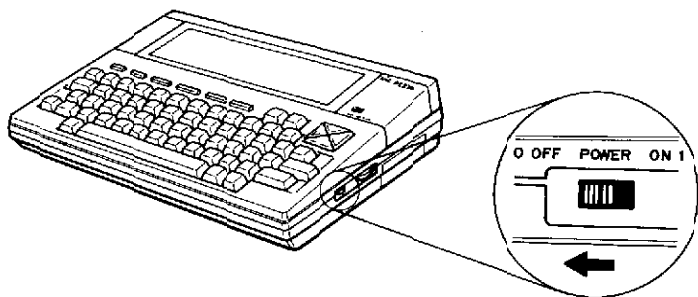

2. Place the PC-8300 face down on a stable and level surface, making sure there is no pressure on the LCD.

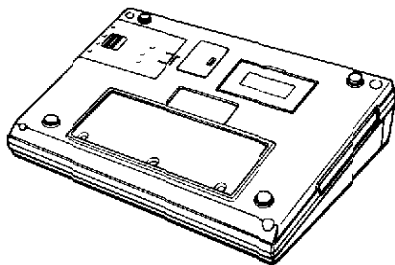

3. Place one of your thumbs at point A and the other thumb on point B as shown below:

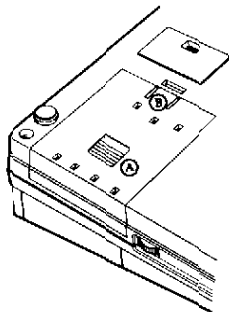

4. Push downward and outward with both thumbs to remove the battery compartment, as shown:

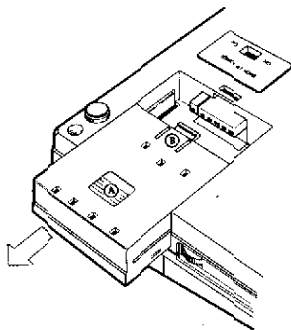

5. Remove the battery case completely and turn it over so that the tab is on the bottom:

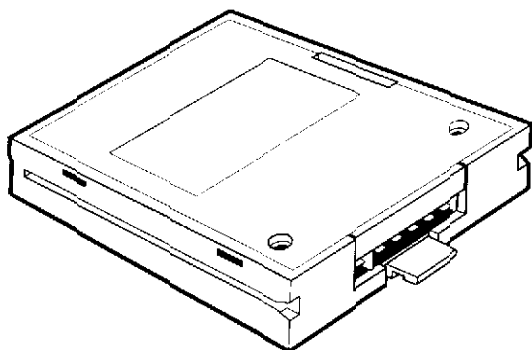

6. Insert a quarter into the slot as shown and gently pry off the top of the battery case:

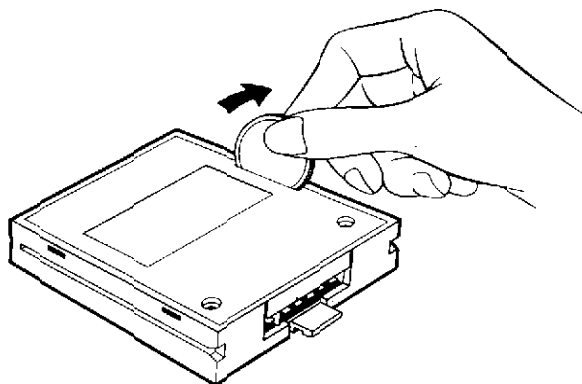

Do not attempt to open the optional NiCd Battery Cartridge (FC-8301A-90 or PC-8201A-90).

7. Insert the four AA size batteries with positive and negative poles positioned exactly as shown in the illustration. All of the negative poles should be touching the springs in the battery case:

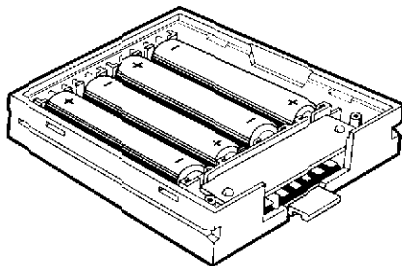

If the batteries are not placed exactly as described, the PC-8300 could be damaged.

8. Snap the top of the battery case in place. Install the battery case as shown:

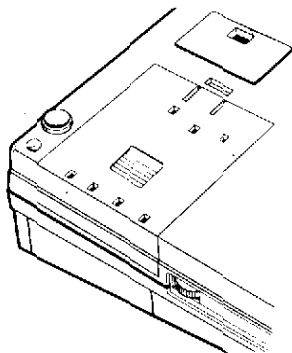

## Battery Life Span

Different types of batteries may be installed in the main battery case. The life span of different batteries will vary according to temperature and other conditions.

- Alkaline Batteries: More than 18 hours
- Standard Batteries: More than 6 hours



## 2.2.2 AC Adapter

If you use your PC-8300 near a wall outlet, the optional AC Adapter (PC-8271A-01), is another convenient power source.

To connect the AC Adapter to the PC-8300, follow these steps.

1. Plug the AC adapter into the wall outlet.
2. With the PC-8300 power switch turned off, plug the single jack end of the PC-8271A-01 into the interface on the rear of the PC-8300, labelled DC 8.5V.

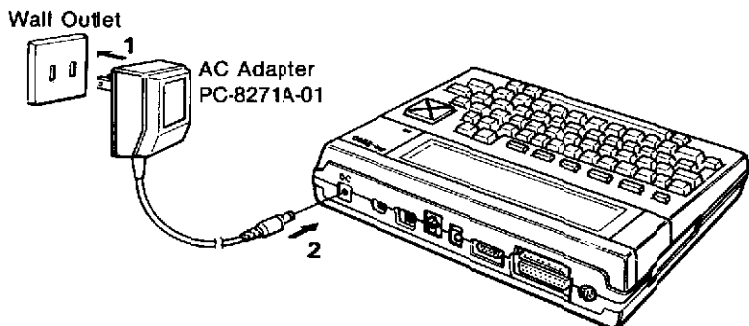

When connecting the AC Adapter, make sure that power to the PC-8300 is off.



When connecting the AC Adapter to the PC-8300 **ALWAYS** plug the adapter into the wall outlet before connecting it to the unit.

When disconnecting, the adapter should first be unplugged from the PC-8300.



Be certain that you use the PC-8271A-01 adapter **ONLY**. Serious damage to the PC-8300 personal computer may be caused by using any other adapter.



If you connect the AC Adapter to the PC-8300 when batteries are inserted in the battery case, then the PC-8300 will operate from the AC Adapter, not from the batteries.

## 2.2.3 NiCd (Nickel-cadmium) Battery Cartridge

The optional NiCd Battery Cartridge (PC-8301A-90 or PC-8201A-90) can be used in place of the regular battery pack containing standard or alkaline AA batteries. The main advantage of using the NiCd Battery Cartridge is that it may be recharged more than 500 times by using the AC Adapter (PC-8271A-01).

The insertion and removal of the NiCd Battery Cartridge in the PC-8300 is performed the same as for a regular battery pack, as described in the section 2.2.1 on battery installation; however the cartridge may not be opened. This battery cartridge is recharged continuously when the AC Adapter is connected to the PC-8300, even when the power switch is turned off.

The AC Adapter supplies electrical power to the PC-8300 via a wall outlet while the NiCd Battery Cartridge is recharging. The recharging process is completed in approximately 48 hours. The NiCd Battery Cartridge should have a full charge prior to using it for the first time.

The NiCd Battery Cartridge should be recharged as soon as possible after the LOW BATTERY LED lights up. Keep in mind that the NiCd Battery Cartridge may not reach its full potential until the unit has been used and recharged 2 or 3 times. Once the NiCd Battery Cartridge can no longer hold a charge, the entire cartridge must be replaced.

Careful handling of this cartridge is necessary for optimum performance. The terminal connector portion of the cartridge should never be touched, and the cartridge should never be dropped. The cartridge should be stored in an area with low humidity.



The use of any AC adapter other than the PC-8271A-01 can cause serious damage to the NiCd Battery Cartridge.

### Battery Life Span

NiCd Battery Cartridge:

More than 5.5 hours

## 2.3 BACK-UP POWER

The BACK-UP POWER switch is located on the bottom of the PC-8300.

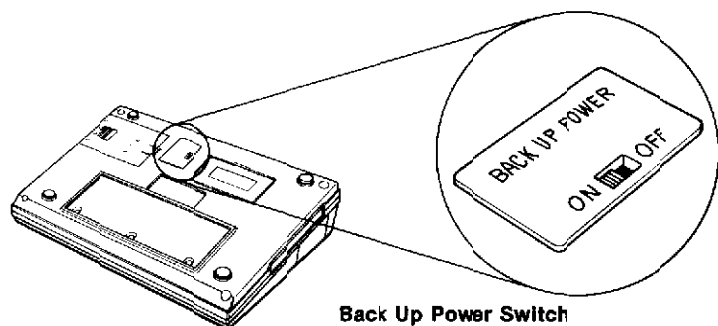

It must be turned on before you switch on the main power supply of the PC-8300 for the first time.

This switch is for the back-up system that is powered by an internal NiCd battery in the PC-8300. Even when the main power supply of the PC-8300 is turned off, the internal NiCd battery maintains the power supply to the PC-8300 so that your files stored in the PC-8300 are saved. It operates only when the POWER switch of the PC-8300 is turned off.

The BACK-UP BATTERY switch should be turned off only if you will not be using the PC-8300 for an extended period (longer than one month) in order to avoid the total discharge of the batteries and deterioration in performance.

The back-up battery will save the files and store them internally for 7 days without any batteries in the battery pack and without an AC Adapter connected to the PC-8300.



When the BACK-UP POWER switch is turned off, all files stored in the PC-8300 will be lost.

Make sure that important files are saved onto an external storage device before you turn the BACK-UP POWER switch off.

Due to their rechargeable nature, the NiCd back-up battery has a total life span of approximately 2 1/2 years. After that time, you will probably need to take the PC-8300 to your NEC agent for replacement, since the internal cell will start to lose their ability to hold a charge.

## **WARNING: Turning the PC-8300 Power On and Off**

Wait at least five seconds between turning the PC-8300 power ON and OFF, or the files contained in the RAM might be destroyed.

78118961

## 2.4 TURNING THE POWER ON AND OFF

### 2.4.1 Turning the Power On

To turn on the power of the PC-8300 for the first time or after an extended period of storage, follow this procedure:

1. Make sure the batteries are inserted properly or that the PC-8271A-01 AC Adapter is properly connected as outlined in Chapter 2.2.
2. Turn on the BACK-UP BATTERY switch on the bottom of the PC-8300.
3. Turn on the POWER switch on the right side of the PC-8300.
4. While holding **SHIFT** and **CTRL** down, press the RESET button or the rear of the PC-8300. Then release both **SHIFT** and **CTRL**. (This procedure is called a 'cold start').
5. Use the contrast adjustment knob on the right side of the PC-8300 so that the LCD display gives the right amount of contrast and light for comfortable viewing.

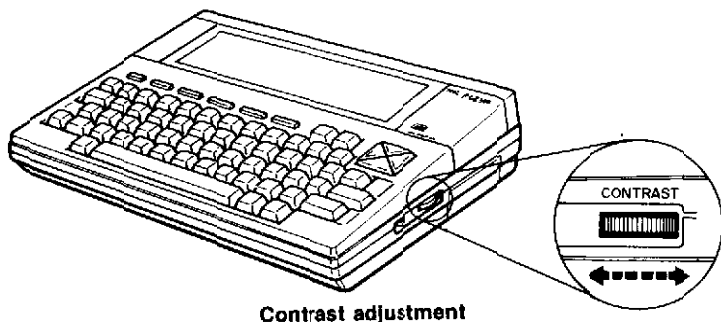

Contrast adjustment

Once the power has been turned on and the screen contrast has been adjusted, the display should always appear as illustrated:

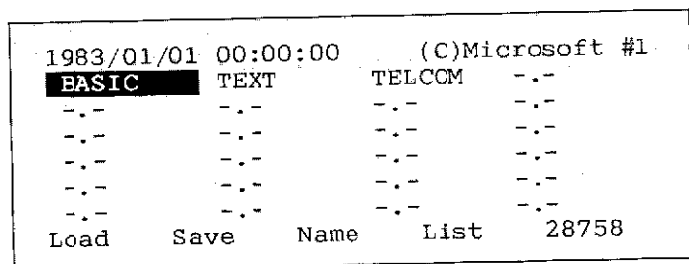

Although you may eventually have more files than shown above, you should at least have the BASIC, TEXT, and TELCOM file names displayed on the screen, since these three are written in the Read Only Memory or ROM. They will not be erased, even by a cold start.

If the screen does not look like this you should perform a cold start, as described in Chapter 3.

To turn the power on for the second and subsequent times, only turn on the POWER switch on the right side of the PC-8300.

## 2.4.2 Turning the Power Off

The power supply to the PC-8300 can be turned off at almost any time, whether you're in an application software program or whether you're in the MENU.

The back-up battery maintains the contents of the memory even when the main power supply is turned off.

### 2.4.3 Automatic Shut Off

When the PC-8300 is on and no key has been pressed for over 10 minutes, the unit's power will automatically shut off to prevent excess discharge of the batteries. When the automatic shut-off function has been activated, the POWER switch has to be manually set to the OFF position and then turned ON again, to turn the PC-8300 back on.



The predetermined time period of 10 minutes after a cold start for the automatic shut-off can be altered using a BASIC language POWER command. The automatic shut-off feature may be canceled by the use of the POWER CONT command when the AC Adapter is connected to the PC-8300. See the BASIC Reference Manual for explanations of these commands.



The only times that the automatic shut-off function cannot be activated is when the PC-8300 is in the terminal mode of TELCOM, and when a BASIC program is being run.

## 2.5 LOW BATTERY LED

If the batteries have a low charge, causing the back-up battery system to be used, the LOW BATTERY LED on the PC-8300 will light up. You should change the batteries when this happens, since you can only operate the PC-8300 for about 20 more minutes from this point.

Storing the PC-8300 for a long time with a low charge will cause it to become inoperable.



If you continue to operate the PC-8300 with the LOW BATTERY LED lit up for more than 20 minutes, the unit will become inoperable and you will lose all of the data stored in the RAM.



Batteries should be replaced as soon as possible after the LOW BATTERY LED lights up. The power switch should always be turned off while changing batteries.

## 2.6 USING THE PC-8300 KEYBOARD'S SPECIAL KEYS

Take a look at the PC-8300 keyboard.

As you can see, almost all the keys on the PC-8300 are the same as on an ordinary typewriter. Keys for letters, numbers, symbols (these keys are called character keys) and the space bar, are light beige. They work just like their counterparts on a typewriter.

The grey keys surrounding the light beige keys are called special keys. The functions they perform depend on what software program is running on the PC-8300.

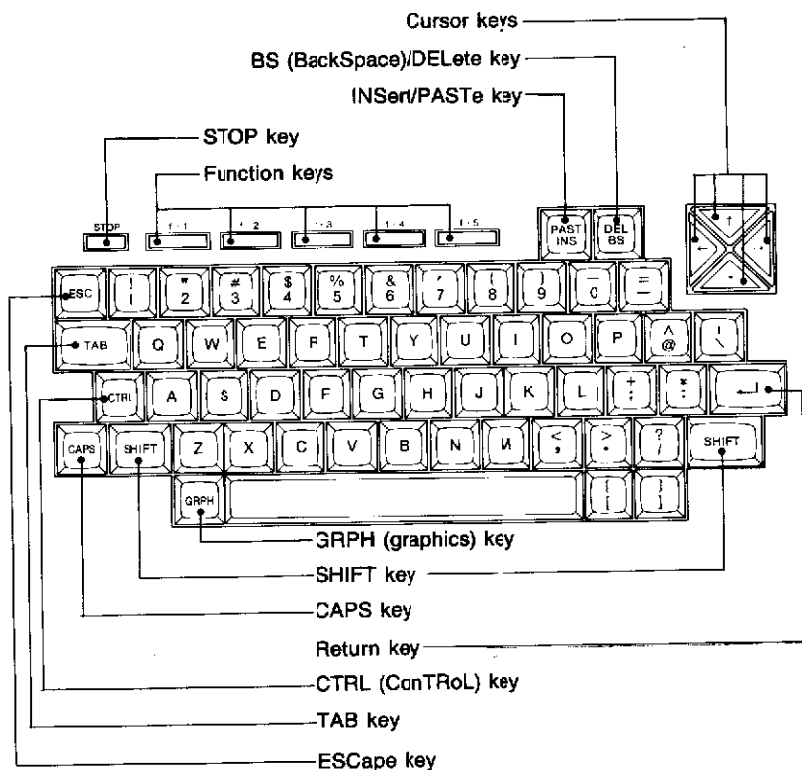



This section describes the general operation of the special keys. More details on how each special key is used within a software program can be found in the manual for that program.

Each software program built into the PC-8300 utilizes the special keys in a way unique to that program. This section briefly describes special key functions common to all the software programs.

### **Function keys**

You can see the **f.1** through **f.5** above the top row of the keyboard; these are called function keys, and they are assigned various commands depending on the software program being used. The currently assigned commands are displayed on the bottom line of the screen. By pressing **SHIFT** with **f.1** through **f.5** respectively, **f.6** through **f.10** are accessed.

### **ESCAPE key**

This key's functions are different for each software program. In combinations with other keys, it is used for many functions. In the TELCOM program, it can be used to send special codes (escape sequences) to a host computer.

### **STOP key**

STOP is used to interrupt the execution of different commands, depending upon the mode, such as BASIC, TEXT, and TELCOM.

To stop the operation of peripheral devices, press **SHIFT STOP**.

### **TAB key**

**TAB** moves the cursor to the right by the designated number of columns. The function of **TAB** differs according to the software program being used.

### **CTRL (ConTRol) key**

Holding **CTRL** while pressing another key will permit you to input a wide variety of commands. The functions resulting from such combinations depend on the software program being used. Please refer to the manual for each software program for more details.

### **CAPS key**

All capital or upper case letters will be displayed while **CAPS** is locked down. This mode is released by pressing **CAPS** once again.

### Cursor keys

The cursor keys move the cursor up, down, to the right and to the left. They're arranged in an easy-to-locate, logical cluster. The functions of these keys vary depending on the current program, such as BASIC or TEXT.

### INSert key

The INSert function is activated by pressing the key marked **PAST INS**.

INSert is used in the BASIC mode for inserting characters into a line immediately before the cursor position. The insert mode is deactivated by pressing a cursor key or by pressing **PAST INS** again.

Notice the shape of the cursor changes to underline ( \_ ) instead of block (█) while in the insert mode.

### PASTe key

To use the PASTe function, hold **SHIFT**, then press **PAST INS**.

The PASTe function allows the contents of the paste buffer to be pasted into a document in the TEXT mode.

### BS (BackSpace) key

To use the BackSpace function, press **DEL BS**.

**DEL BS** (BackSpace) erases characters as it moves the cursor back over them. Characters or lines of text after the cursor position will be pulled backwards.

### DELeTe key

To use the DELeTe function, hold **SHIFT** and press the key marked **DEL BS**.

**SHIFT DEL BS** deletes characters forward from the cursor position, and any characters following the cursor are pulled backwards.

### Return key

The Return key is used to tell the computer that you have finished your typing, and that you wish to input the command or line into the PC-8300.

**↵** also marks the end of lines used in BASIC or TEXT files.

In the MENU mode, **↵** confirms which file to open or execute.

The function of this key depends on the software programs being used.

### SHIFT key

The SHIFT key works just like its counterpart on a typewriter.

It causes upper-case (capital letters) to be output when a key is typed while **SHIFT** is held down. The special symbols labelled on the top half of some keys are accessed by holding **SHIFT** and pressing those keys. This key also gives access to **f.6** to **f.10**.

### GRPH (graphics) key

When the Z, X, and C keys are pressed while **GRPH** is held down, graphics symbols are generated.

**GRPH Z** : ◀

**GRPH X** : ▶

**GRPH C** : ☼

The PC-8300 can have 125 graphic symbols that may be defined and stored in RAM; among these characters, 93 symbols can be typed by using

**GRPH**.

# CHAPTER 3

## INFORMATION ABOUT THE MEMORY

---

<b>3.1 MEMORY CAPACITY</b> .....	34
<b>3.2 WARM START AND COLD START</b> .....	35
3.2.1 Back-up Power .....	35
3.2.2 When and How to Use a Warm Start and a Cold Start .....	36
3.2.3 Turning the PC-8300 on by a Warm Start .....	36
3.2.4 Initializing The PC-8300 RAM With A Cold Start .....	37
<b>3.3 MEMORY PROTECTION</b> .....	39
<b>3.4 RESET SWITCH</b> .....	41



## 3.1 MEMORY CAPACITY

The PC-8300 has 64K bytes of internal RAM, and 128K bytes of internal ROM. You can enhance the RAM with the optional RAM cartridges.

The PC-8207A Expansion RAM Cartridge has four blocks of 32K bytes each, which increases the total available RAM to 192K bytes.

The PC-8205A Expansion RAM Cartridge holds 32K bytes of RAM, which increases the total available RAM to 96K bytes.

For more details, please refer to Chapter 6.5.

The total available RAM is divided into units referred to as "banks". One bank contains 32K bytes of memory.

If your PC-8300 has no Expansion RAM Cartridge, the total RAM available to you is 64K bytes, divided into two internal memory banks of 32K bytes each, referred to as bank #1 and bank #2.

Please see the figure below.

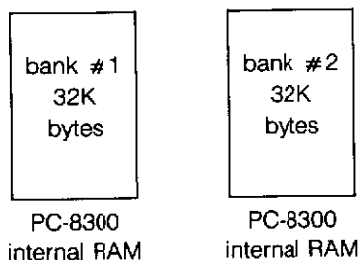

When you use the PC-8206A Expansion RAM Cartridge, you will have another bank as bank #3.

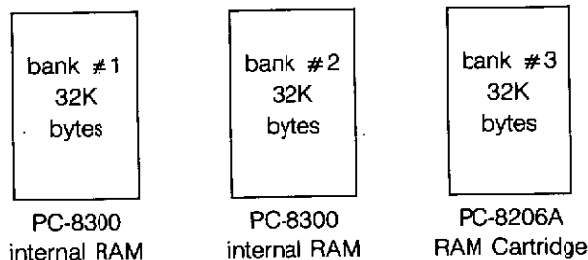

The PC-8207A Expansion RAM Cartridge is used in the same way as the PC-8206A, but it has four times the memory capacity of the PC-8206A RAM, with a switch that lets you select one of the four 32K byte blocks of memory to use as bank #3. The PC-8300 can at any one time recognize and access a maximum of three memory banks, although there may in fact be six banks present (two in the PC-8300 and four in the PC-8207A).

## **3.2 WARM START AND COLD START**

It is important that you clearly understand the two ways to boot your PC-8300 computer, since they are very different, are used in different situations, and have very different results. These two booting methods are called "Warm Start" and "Cold Start" respectively.

### **3.2.1 Back-up Power**

The PC-8300 is a portable personal computer, so it is not always used on a desk. NEC designed the PC-8300 to be convenient to carry, and to be usable without the need of external storage devices or an AC power outlet.

For most users, it is necessary to store data and programs; thus the PC-8300 is the answer to their dreams since its internal RAM has the capability to store files even after the computer has been turned off, (always backed up by the internal NiCd battery) while the BACK UP POWER switch is ON. The power to keep the contents stored in the RAM is called back-up power.

The internal NiCd battery is charged while the PC-8300 is being supplied with power (refer to the previous chapter) by an AC Adapter, AA batteries, or an NiCd Battery Cartridge).

The PC-8206A and PC-8207A Expansion RAM Cartridges have Lithium batteries for back-up power.

### 3.2.2 When and How to Use a Warm Start and a Cold Start

The usual method of turning on the power is called a "warm start" by which the PC-8300 is turned on without initializing (clearing) the file storage area, the data in its RAM or the setting of the real-time clock. Any files previously created and stored in the RAM are still saved there.

A cold start initializes (clears) the RAM areas, so any files you may have had there will be erased. A cold start is used to start the computer for the first time, after a long period of non-use, and also to escape when "hung up". When turning on the BACK-UP POWER switch, it is necessary to initialize all of the RAM by performing a cold start. Also, when you want to clear the RAM of all the files, perform a cold start.

### 3.2.3 Turning the PC-8300 On by a Warm Start

When you have a file(s) in RAM that you wish to keep, turn on your PC-8300. This consists of merely turning the POWER switch on the right side to ON.

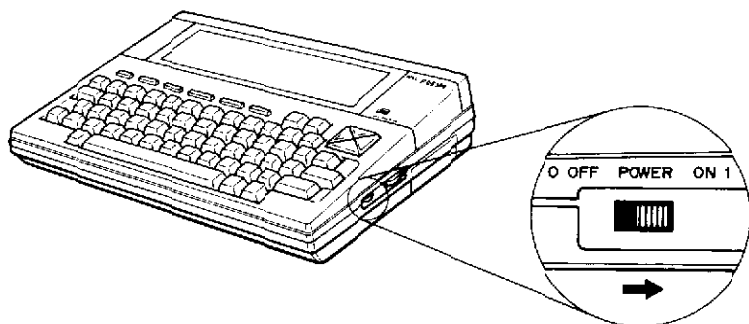

If the power of the PC-8300 has been automatically turned off by its own function but the POWER switch is still set to the ON position, change this to the OFF position, and then turn it on again.

A warm start is the way you normally turn on your PC-8300 since you will usually want to retain files which have been previously saved in RAM.

Usually the MENU is displayed on the screen after a warm start. If the PL (Initial Program Loader) is set, it will be executed after a warm start.



If the PC-8300 is turned off while executing a job (for example, while a BASIC program is running), the PC-8300 will continue that job when next it is turned on by a warm start.

### 3.2.4 Initializing the PC-8300 RAM with a Cold Start

A cold start is performed when you want to initialize the internal RAM, or to escape from being hung-up.

A separate cold start is performed for each memory bank. A cold start for bank #1 is different from that for banks #2 and #3.

Follow these steps to cold start the various memory banks.

#### Cold Start of Bank #1

1. Turn the BACK-UP POWER switch to the ON position.
2. Turn the POWER switch to the ON position.
3. In the MENU mode, hold **SHIFT** and **CTRL** down.
4. Press and release the RESET switch on the back of the PC-8300.
5. Release **SHIFT** and **CTRL**.

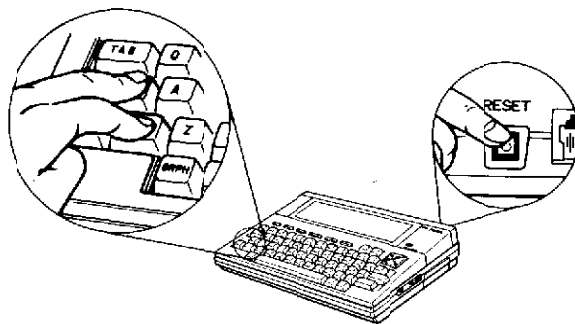



The screen is erased for an instant after a cold start, and then the MENU appears on the screen. Since the RAM has been completely erased and initialized, the MENU displays no file names other than the three primary files BASIC, TEXT, and TELCOM, since they are in ROM.

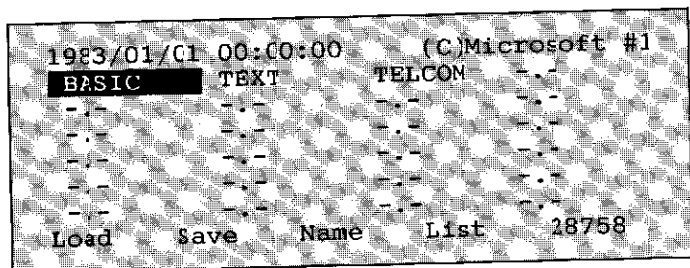

 Before performing a cold start, be sure that important files have been saved on some external storage medium, such as a cassette tape or a floppy disk; otherwise all your files will be lost.

### Cold Start of Bank #2 and Bank #3

Follow these steps to cold start bank #2.

1. A cold start is usually performed in the MENU mode.  
If not in the MENU mode, try to exit to it.

From the BASIC mode, press **f.10** at the "Ok" prompt.

From the TEXT mode, press **ESC** twice, to save your file and exit to the main MENU.

From the TELCOM mode, press **f.10**.

2. Select bank #1 by using the BANK command (**f.10**) while in the MENU mode. At the top right corner of the screen, you will see the bank number indicator. When bank #1 is selected, the top right corner of the screen looks like this:



3. The next two steps must be performed immediately following each other, with no time apse in-between.

Hold **[SHIFT]**, then

(1) Press **[5]** while still holding **[SHIFT]**.

The screen will clear for an instant: at this time, and the bank number indicator will change to #2.

(2) When the screen has been cleared and while still holding **[SHIFT]**, press **[CTRL]**.

This process will not work if **[SHIFT]** is released before step (2) is completed. The screen clears instantly and the current bank is changed to #2 after step (1). Step (2) must be performed during the short interval after the screen is cleared, but before a new screen is displayed.

If the cold start for bank #2 does not work, try it again.

It is possible that too much time elapsed between steps (1) and (2).

Bank #2 should be cleared of all files if the cold start has been performed successfully.

To clear bank #3, steps (1) and (2) above are repeated exactly as for bank #2, with the exception that the procedure is started when bank #2 is the current bank. In this case, the first step will switch to bank #3.

### 3.3 MEMORY PROTECTION

The PC-8300 and the RAM Cartridges have a facility for memory protection. Bank #2 of the PC-8300, bank #3 on the PC-8206A RAM Cartridge, and three of the four banks of PC-8207A RAM Cartridge can be protected.

If you have some very important files that you don't want to change or delete, it is recommended to save them in the banks that can be protected.

## Memory Protection of Bank #2

The PROTECT switch, set to the ON position, prevents data from being entered into or erased from bank #2.

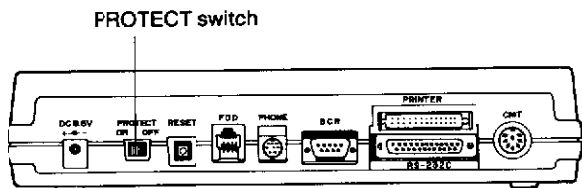

Rear view of the PC-8300

After you set the PROTECT switch to the ON position, you can't select or use bank #2. If you need to access files in it, then simply turn the protection off.



Before turning the PROTECT switch on, be sure the power of the PC-8300 is turned off.

## Memory Protection of Bank #3

The RAM cartridge PC-8206A or PC-8207A will be bank #3 for the PC-8300.

The PROTECT switch on the PC-8206A will protect bank #3 in the PC-8206A from deletion or change.

The PC-8207A RAM Cartridge has a select switch that selects one of the four 32K byte RAM banks.

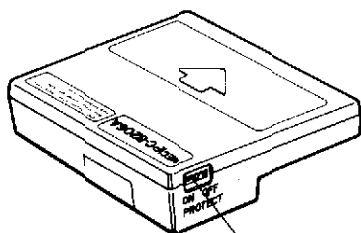

BLOCK switch of the PC-8207A RAM Cartridge

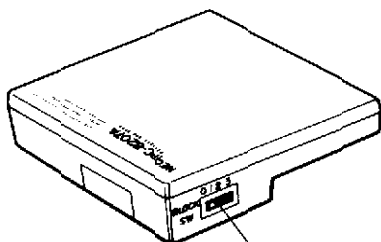

PROTECT switch of the PC-8206A RAM Cartridge

### PC-8207A RAM Cartridge side view

Refer to Chapter 6.5 for more details.

## 3.4 RESET SWITCH

The RESET switch is located on the back of the PC-8300.

As mentioned previously the RESET switch should not be used often since it may cause the programs and files stored in the RAM to be erased.

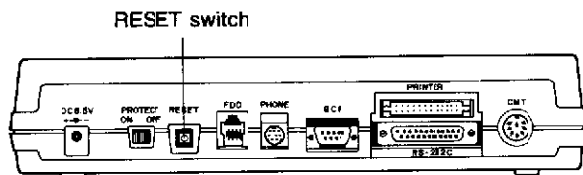

Rear view of the PC-8300

The RESET switch is used during the cold start process and as part of a sequence for freeing the PC-8300 when "hung up"

The PC-8300 is said to be "hung up" when it does not respond to commands input from the keyboard. This should not happen when using the built-in software features but may occur while using customized programs.

## What to do when you cannot control your PC-8300 from the keyboard ("hung up"):

Step 1. Press **CTRL Q**

**CTRL Q** is used to escape from the halt mode. (**CTRL S** starts the halt mode). If it is not in the halt mode, step 1 will have no effect, so continue to step 2:

Step 2. Press **STOP**

Usually BASIC programs can be stopped by step 2. If the problem is still not resolved, continue to step 3:

Step 3. Press **SHIFT STOP**

Step 3 will stop the PC-8300 communicating with the peripheral devices.

If your PC-8300 still cannot be controlled, continue to step 4:

Step 4. Perform a warm start (turn off the PC-8300 and then turn the power back on).

Usually, steps 1 through 4 will be the only action needed to regain control of your PC-8300. After succeeding with one or more of the above steps, your files in RAM are saved.

Unfortunately, if your PC-8300 got hung-up while running a machine language program, steps 1 through 4 may not work and you will have to perform the following steps:

Step 5. Press the **RESET** switch.



Step 5 may erase all the files in RAM, but if it works and your PC-8300 is under your control with the files still intact, you should save the files onto a cassette tape or a floppy disk as soon as possible, and perform a cold start.

The reason for this is that after pressing the **RESET** switch, the condition of the PC-8300 may be unsettled, so it is recommended that you do not keep the files that were in RAM.

When step 5 frees the PC-8300 from being hung up, the last step is a cold start that will initialize the RAM completely.

Step 6. Perform a cold start (while holding down **SHIFT** and **CTRL**, press and release the RESET switch).



In any situation requiring you to perform a cold start, remember that the files contained in RAM will be erased.

# CHAPTER 4

## UNDERSTANDING THE MENU

---

<b>4.1 LOOKING AT THE MENU</b> .....	47
<b>4.2 INTRODUCING THE BUILT-IN SOFTWARE</b> ....	48
<b>4.3 FILES</b> .....	50
<b>4.4 SETTING TIME AND DATE</b> .....	52
<b>4.5 STARTING A PROGRAM</b> .....	55
4.5.1 Starting a Built-in Program .....	55
4.5.2 Starting and Automatically Opening a Document File .....	56
4.5.3 Executing a Program from the MENU .....	57
<b>4.6 EXITING TO THE MENU MODE</b> .....	57



In Chapter 2, you looked at the various parts of the PC-8300 and became familiar with the computer. You also learned how to turn on the PC-8300 and some of the functions of the internal RAM.

This chapter introduces the PC-8300 MENU. The MENU is the home base of the PC-8300. All the operations of the PC-8300 start from the MENU, and the PC-8300 returns to the MENU when operations are completed. The MENU displays everything you can do with the PC-8300. When the PC-8300's power is turned on, the MENU is the first thing you see.

The PC-8300's MENU was specially developed to be friendly and easy to use. All the MENU commands are of course "menu-driven" and "query-driven", so you just select from the menu and answer the questions.

The RAM in the PC-8300 can store many files, such as programs in BASIC or machine language, and also text files. The MENU controls the handling of these files. The following operations can be performed from the MENU mode:

- Display file names
- Change file names
- Copy files
- Delete files
- Save files to external devices
- Load files from external devices
- Set or clear the IPL program
- Switch between memory banks

This chapter describes the basic concepts of the MENU so that first-time computer users will be able to understand how the MENU controls the PC-8300.

Please refer to the next chapter for more detailed information on the MENU commands.



## 4.1 LOOKING AT THE MENU

After you perform a warm start, the PC-8300 MENU screen looks like this:

Names of the three built-in programs

Directory cursor

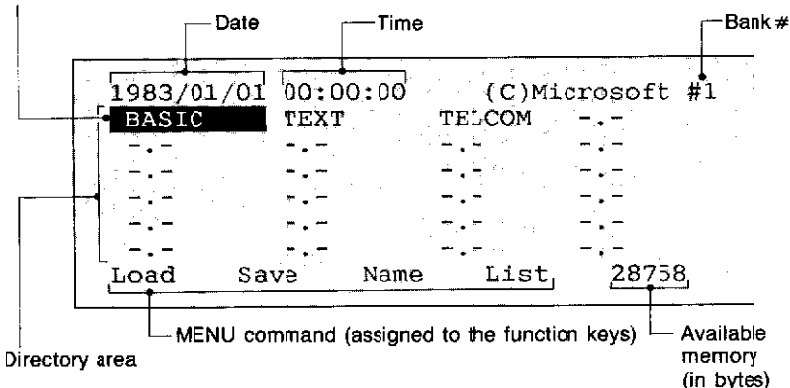

**Date and time:** The year, month, day of the month, and the time are listed here. These values can be changed in the BASIC mode using the BASIC DATES\$, and TIMES\$ instructions.

**Bank #:** Indicates the current memory bank number.

**Directory area:** The names of files that are stored in the current memory bank are displayed here. The first three names are those of the built-in software; these appear on the display of every memory bank. You can store up to 21 files in each memory bank.

**Directory cursor:** The inverse video rectangle which can be moved around the directory area is called the directory cursor. Its movement is controlled by the cursor keys and the space bar, and it can be moved up, down, to the right, and to the left around the directory area in order to select a file name.

**Available memory:** The value here indicates how much memory is available to you for saving files in RAM. If this value is too small you cannot save files and you cannot create files; to solve this problem, you must erase a file.

**MENU commands:** The MENU has eight commands assigned to the function keys. The assigned functions are as follows:

- "Load" f.1
- "Save" f.2
- "Name" f.3
- "List" f.4

When you hold SHIFT, these function keys have another set of functions assigned to them, as follows:

- "SetIPL" f.6
- "ClrIPL" f.7
- "Kill" f.9
- "Bank" f.10

Note that f.5 just indicates the amount of memory available in the current memory bank, and f.8 has no function.

Please refer to Chapter 5 for more detailed information on the MENU commands.

## 4.2 INTRODUCING THE BUILT-IN SOFTWARE

This section introduces and briefly describes the three built-in software packages of the PC-8300. Please refer to the appropriate manual for more details on each of these software packages.

### BASIC

BASIC is a popular programming language for personal computers. N82-BASIC is the modified form of Microsoft BASIC specifically prepared for the PC-8300. N82-BASIC has been designed to fully utilize the many features of the PC-8300. With some study and practice, you too can soon write BASIC programs for your own use.

N82-BASIC supports:

- programmable function keys,
- a real-time clock,
- a sound generator,
- etc.

N82-BASIC also controls various external devices such as:

- data recorders,
- printers,
- Micro Disk Unit,
- etc.



N82-BASIC for the PC-8300 has been enhanced to support a Disk Unit, and a CRT Adapter.

There is also a BASIC command called POWER with which you can program the automatic power-off function of the PC-8300.

## **TEXT**

TEXT is a complete word-processing system that makes it easy for you to create any kind of letter or document. TEXT offers all the features of the most advanced electric typewriters, plus many more features not found on any typewriter.

### **Editing**

You can make changes, insertions or deletions at any time, even after you have typed a document.

### **Moving**

You can move words, sentences, paragraphs or even entire chapters from one location to another.

### **Viewing**

On the LCD screen you can see up to eight lines of text at a time.

### **Printing**

You can print your TEXT file on a variety of printers. Most printers can use bold type and underscoring to emphasize important points.

### BASIC Editing

You can edit EASIC programs using TEXT, and you can even enter the TEXT mode from BASIC, conveniently edit your program, and then switch back to BASIC.

### Special Effects

You can embed escape sequences for your particular printer into your document to perform special printing effects.

## TELCOM

TELCOM is the ROM-based telecommunications program built into the PC-8300. This program is powerful and easy to use. Using either the RS-232C interface or the optional Modem Card, (PC-8361A) practically every method of data communications is possible.

TELCOM offers these features:

Data communications at baud rates from 75 to 19200.

With the Modem Card:

- Automatic dialing by either typing a telephone number or selecting it from a telephone directory file.
- Automatic log-on by selecting from a telephone directory file.
- Two different protocols for uploading and downloading document files — standard ASCII file transfer and the Xmodem protocol for file transfer with error checking procedures.

## 4.3 FILES

The names of any files that have been saved in RAM will appear in the MENU directory.

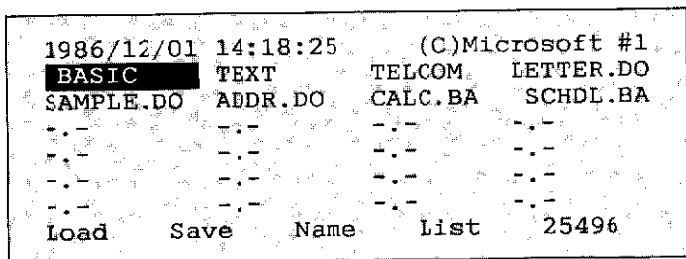

The fact that the names of these files appear in the MENU directory is proof that they have been saved in RAM.

A file can be created and/or saved in the RAM of the PC-8300, either from the MENU, BASIC, TEXT or TELCOM mode. The files saved in RAM will not be erased when you turn off the main power of the PC-8300, because the back-up batteries keep the RAM "alive".

A file name consists of three parts:

- The main name, consisting of up to six characters
- A period used to separate the first and last parts of the name
- The file-type extension, consisting of two characters

Although a file name can consist of many types of characters, it is recommended that you use letters of the alphabet instead of numbers and symbols, in order to avoid name errors which result in the error message (?NM Error) being displayed. If this error message appears, you must try again, using a legal file name.

Examples of legal file names with their file-type extensions:

**CALC.BA**

**LETTER.DO**

The ".BA" and ".DO" are file-type extensions added by the PC-8300, according to the mode being used to create the file. Thus, when you are naming a file, you need only supply the first part of the file name.

A file name may be typed in using upper or lower case letters, and the name displayed on the screen will appear exactly as it was typed in. However, the file-type extension will always be displayed in upper case letters, no matter how you typed it in, since this is assigned by the PC-8300.

Types of file name extensions:

- |     |                                                                                                          |
|-----|----------------------------------------------------------------------------------------------------------|
| .BA | BASIC program files in binary format                                                                     |
| .DO | TEXT document files, and both BASIC data files and BASIC program files which were saved in ASCII format. |
| .CO | Both machine language program files and machine language data files in machine language format.          |

The file-type extension can be keyed in by you, or otherwise it is automatically supplied by the PC-8300, according to the mode you are using. For example, if you are currently in the BASIC mode when you create a BASIC program file, the file-type extension assigned by the PC-8300 would be ".BA"

When loading or saving files to or from RAM, the PC-8300 checks the file-type extensions. Thus you could use the same name as the first part of several different file names, and as long as the file-type extensions are different, the computer will have no problem recognizing the files correctly.

The maximum number of files that can be stored in each of the three memory banks is 21. Since there is a limit to the total available memory space, the actual number of files which you will be able to store will depend on the total size of the individual files.

If, while in the BASIC mode, you attempt to store more files than permitted in a memory bank, the error message FL Error (File Limit error) will be displayed if the PC-8300 is in the BASIC mode.

If the PC-8300 is in the TEXT mode, a warning BEEP will sound. If the current mode is the TELCOM mode, the error message "Download Aborted" will be displayed.

Files are displayed on the screen in the following order:

Machine language files	with file-type extension .CO
TEXT files (and other ASCII-format files)	with file-type extension .DO
BASIC files (Binary format)	with file-type extension .BA

## **4.4 SETTING TIME AND DATE**

The built-in real-time clock of the PC-8300 continues to run even after the main power is turned off, since it is powered by the NiCd battery.

The date and time can be set by using the BASIC instructions, TIME\$ and DATE\$.

```

1986/12/01 14:18:25      (C)Microsoft #1
BASIC TEXT TELCOM LETTER.DO
SAMPLE.DO ADDR.DO CALC.BA SCHL.BA
-- -- -- --
-- -- -- --
-- -- -- --
-- -- -- --
Load Save Name List 25496

```

The above illustration shows the PC-8300 screen after turning it on. The directory cursor is on "BASIC", so by pressing  the BASIC mode is entered, with the screen changing to that shown below.

```

NEC PC-8201 BASIC Ver 1.1 (C) Microsoft
28758 Bytes free
OK
■

Load " Save " Files List Run

```

The PC-8300 is now in the BASIC mode.

To set the date:

Use the following BASIC instruction to enter the date, in double-digit format YY/MM/DD. In this format, YY represents the last two digits of the year, MM represents the month, and DD represents the day of the month. All of these must be entered in double-digit format. If a number consists of a single digit, you must type a zero (0) before it.

Examples:

May 7th, 1987 would be entered as:

**DATE\$="87/05/07" **

Christmas Day, 1986 would be entered as:

**DATE\$="86/12/25" **



Make sure that the double quotation marks are typed in the command exactly as shown above.

If an "Ok" message appears on the screen after you have entered the date, it means that your entry procedure was successful.

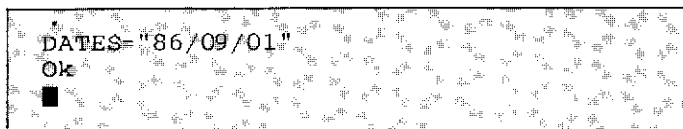

If the error message "?SN Error" (syntax error) appears on the screen, it means that you made an error in the date entry procedure. Go back and check the format, and re-enter the date correctly.

To set the time:

Use the TIME\$ command of BASIC, and input the data in double digit format between double quotation marks as shown below.

**TIME\$="HH:MM:SS" ←**

HH represents the hour on the 24-hour clock, MM represents minutes, and SS represents the seconds. If any of these numbers are single digits, then type a zero (0) in front of it to conform to the two-digit format.

Examples:

To set the time at 30 seconds past 2:07 pm:

**TIME\$="14:07:30" ←**

To set the time at exactly 8:45 am:

**TIME\$="08:45:00" ←**

The PC-8300 uses a 24-hour clock, so pm times are shown as hours over 12, such as 16 for 4 pm etc.

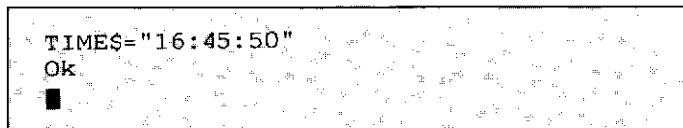



If you have correctly entered the time, the message "Ok" will appear on the screen as shown above. From now on, the correct time should be displayed on the top line of the MENU mode display

Consult the BASIC Reference Manual for a description of the use of EASIC commands, DATE\$ and TIME\$, used for setting the date and time.

## 4.5 STARTING A PROGRAM

### 4.5.1 Starting a Built-in Program

When the PC-8300 is turned on, it is generally in the MENU mode. You can select one of the built-in programs, one of your files, or any file operation command from the MENU.

When you turn the POWER switch on you will see the file name BASIC inversely displayed on the second line of the MENU screen. This inverse image is called the directory cursor.

The directory cursor is moved by using the four cursor keys or the space bar. You select one of the built-in programs or one of your files by moving the cursor over its file name, and pressing .

For example, to enter in the TEXT mode, locate the directory cursor over the file name TEXT:

```

1986/12/01 14:18:25      (C)Microsoft #1
BASIC      TEXT      TELCOM  LETTER.DO
SAMPLE.DO  ADDR.DO   CALC.BA  SCHDL.BA
.-.-      -.-      -.-      -.-
.-.-      -.-      -.-      -.-
.-.-      -.-      -.-      -.-
.-.-      -.-      -.-      -.-
Load      Save      Name      List      25496

```

and press . Now you have entered the TEXT mode.

```

File to edit? █

```

The BASIC mode and the TELCOM mode are started in the same way, by moving the directory cursor over the name of the desired mode, and then pressing .

## 4.5.2 Starting and Automatically Opening a Document File

Document files can be quickly opened. When you have document files, (which have the .DO extension) in RAM, you can enter the TEXT mode and also open one of the document files by a one-step operation.

For example, if you have a document file named "LETTER.DO", place the directory cursor over this file name,

```
1986/12/01 14:18:25 (C)Microsoft #1
BASIC      TEXT      TELCOM  LETTER.DO
SAMPLE.DO  ADDR.DO  CALC.BA  SCHDL.BA
--         --         --         --
--         --         --         --
--         --         --         --
--         --         --         --
Load      Save      Name      List      25496
```

and press . Then PC-8300 enters the TEXT mode, and opens the text file called "LETTER.DO".

```
Dear Mr. Jones,
We are planning to arrive in New York on
January 12 and will be staying at the
Sheraton Hotel.
```

### 4.5.3 Executing a Program from the MENU

BASIC programs (which have the extension ".BA"), and machine language programs (which have the extension ".CO"), can be executed quickly by locating the directory cursor over the file name of the program file you want to execute, and pressing .

For example, locate the directory cursor over the file name "SCHDL.BA" as on the screen shown below:

1986/12/01	14:18:25	(C)Microsoft #1	
BASIC	TEXT	TELCOM	LETTER.DO
SAMPLE.DO	ADDR.DO	CALC.BA	<b>SCHDL.BA</b>
--	--	--	--
--	--	--	--
--	--	--	--
--	--	--	--
Load	Save	Name	List
			25496

and press .

The PC-8300 enters the BASIC mode, and executes "SCHDL.BA".

Therefore it is not necessary to type in the RUN command or EXEC command after you enter the BASIC mode, if you just want to run programs without editing or writing them.

## 4.6 EXITING TO THE MENU MODE

The MENU mode is the home base of the PC-8300, you will often want to exit to this mode from the other modes and programs.

### From the BASIC Mode

BASIC has the MENU command to let you exit to the MENU mode. The MENU command is assigned to .

At the command level (a block cursor is flashing under the "Ok" prompt ), type:

**MENU**

and press **←** ,

or alternatively, use **f.10** (this means hold **SHIFT** and press **f.5**).

```
1986/12/01 14:18:25      (C)Microsoft #1
BASIC      TEXT      TELCOM  LETTER.DO
SAMPLE.DO    ADDR.DO    CALC.BA  SCHDL.BA
.-.-        .-.-      .-.-      .-.-
.-.-        .-.-      .-.-      .-.-
.-.-        .-.-      .-.-      .-.-
.-.-        .-.-      .-.-      .-.-
Load        Save      Name      List      25496
```

Now you are in the MENU mode.

You can also include the MENU command in your programs.

**From the TEXT mode**

The MENU command of TEXT is assigned to **f.10** . You can see it by pressing **f.6** (KEYS) while in the TEXT editing mode. You can also exit to the MENU mode by pressing **ESC** twice.

Exiting to the MENU mode closes and saves your current document automatically.

**From the TELCOM mode**

The MENU command of TELCOM is also assigned to **f.10** . You can directly access the MENU mode except when in the terminal mode. At the "Telcom:" prompt, press **f.10** to return to the MENU mode. If you are in the terminal mode, press **f.10** (BYE) and type Y to exit from the terminal mode, and then press **f.10** (MENU)

# CHAPTER 5

## MENU COMMANDS

---

<b>5.1 LOAD</b>	<b>f.1</b>	.....	61
5.1.1	Device Name and File Name (Response to the "Load from" Prompt)	.....	63
5.1.2	File-type Extensions	.....	64
<b>5.2 SAVE</b>	<b>f.2</b>	.....	65
5.2.1	Device Name and File Name (to the "Save Filename as" Prompt)	.....	67
<b>5.3 NAME</b>	<b>f.3</b>	.....	69
<b>5.4 LIST</b>	<b>f.4</b>	.....	70
<b>5.5 SETIPL</b>	<b>f.6</b>	.....	72
<b>5.6 CLR IPL</b>	<b>f.7</b>	.....	74
<b>5.7 KILL</b>	<b>f.9</b>	.....	75
<b>5.8 BANK</b>	<b>f.10</b>	.....	76



In the PC-8300 MENU mode, there are eight commands assigned to the function keys. These commands are activated by pressing the respective function keys. In most cases, in response to pressing one of these function keys, a message will appear on the bottom line of the screen requesting a file name or some other data to be entered.

The following list shows the eight commands assigned to these function keys.

<b>Command</b>	<b>Function key</b>	<b>Function of the command</b>
LOAD	f.1	Loads a file from a specific external device* and saves it in the current RAM bank.
SAVE	f.2	Saves a file from the RAM bank to a specified external device*.
NAME	f.3	Changes the name of a file in the current RAM bank.
LIST	f.4	Also outputs the contents of a file which is in the current RAM bank to a parallel printer.
SETIPL	f.6 (SHIFT f.1)	Sets the Initial Program Load (PL) command which is automatically executed by the PC-8300 when turned on.
CLR IPL	f.7 (SHIFT f.2)	Resets the IPL command.
KILL	f.9 (SHIFT f.4)	Deletes the specified file from the current RAM bank.
BANK	f.10 (SHIFT f.5)	Switches RAM banks.

\* In this User's Guide, only the use of a data recorder and RS-232C devices are explained. If you want to use a disk drive, please refer to the Micro Disk Unit PC-8231A User's Guide.

## 5.1 LOAD f.1

### FUNCTION

The LOAD command loads a file from a specific external device and saves it in the current RAM bank. The specified external device can be a data recorder, the Micro Disk Unit, or some other device connected to the RS-232C serial port of the PC-8300.

### OPERATION

1. Connect the necessary external device to the PC-8300.
2. Turn on the external devices and the PC-8300.
3. In the MENU mode, select the bank by pressing f.10 (see details of the BANK command at the end of this chapter). You can see the bank number on the upper right corner of the MENU screen.
4. Press f.1. You will see the following message on the last line of the screen:

Load from \_

5. This prompt is asking you to specify the name of the external device and the name of the file which you want to load.

For example, to load a document file named "TEST" from a cassette tape: (refer to next subsections about the other devices and other type of files);

Type

**TEST**

or

**CAS:TEST**

and press ↵.

"CAS:" is the device name for a cassette tape recorder, and since it is the default value, it can be omitted.

6. The next prompt will appear on the last line of the screen:

Save as \_

This prompt is asking you to specify the file name you want to assign to the file when it is stored in the current RAM bank, including the correct file type extension.

In this example the file is a document, type:

**TEST.DO**

and press . ".DO" is the file-type extension for document files.

7. If you have a file which already has the same name (TEST.DO), the following prompt will be displayed:

Save as *filename* Sure? \_

Type Y (for Yes) if you want to overwrite the previous version of that file with the new version. If you don't want to overwrite it, type N, to cancel the LOAD command

8. The next prompt is asking you if you have correctly set the device, (in this case, a data recorder), by pressing the PLAY button, and so on. When you have everything ready, press Y

Save as *filename* Ready? \_

9. In this example, we will describe the use of a data recorder. If some files have already been saved onto the tape in front of the file named "TEST", the PC-8300 will inform you of the names of those files as they are being skipped over, until it reaches the specified file.

For example:

Skip :CALC

10. When the PC-8300 finds the file "TEST", you will see:

Found :TEST

11. After loading the file, you can find this new file name on the MENU screen.



```

1986/12/01 14:18:25      (C) Microsoft #1
BASIC  TEXT      TELCOM      TEST.DO
--
--
--
--
Load      Save      Name      List      28523

```



If you want to interrupt the loading process, press **SHIFT STOP**.



When the maximum number of files (21) are already present in the RAM, any attempted use of "Save as" will result in an error except when you are using one of the file names already saved. This will also happen if the available memory becomes full during the loading process. The best way to solve this situation is to create extra available memory space by deleting unwanted files with the KILL command, and then try loading once more.

### 5.1.1 Device Name and File Name (Response to the "Load from" Prompt)

Your response to the "Load from" prompt of the LOAD command designates the specific device name and file name:

***device-name:filename***

The *device-name* can be designated:

CAS: cassette tape

COM: device connected to the RS-232C port



If the *device-name* is omitted, the use of a data recorder will be assumed, since "CAS:" is the default.

The file name can be designated when the "CAS:" is used as a *device-name*. However, when both "CAS:" and the *filename* are omitted, the first file read from the cassette tape will be loaded.

When "COM:" is used as a *device-name*, specify the communications parameters instead of a file name. If this parameter is omitted, the procedure will be performed with the current status (the latest specified by the TELCCM STAT command, the TEXT PFINT command, or the BASIC OPEN"COM: command).

Refer to the TELCOM manual for details on the communications parameters.

The responses to the "Load from" prompt, external device, and the resulting file name are listed.

Response to "Load from"	External Device	Name of File Loaded
no response	Data recorder	(no name, but first file found on tape is loaded)
TEST	Data recorder	TEST
CAS:TEST	Data recorder	TEST
COM	RS-232C serial device	(current mode)
COM:8171XN	RS-232C serial device	(8171XN)

## 5.1.2 File-type Extensions

When responding to a "Save as" prompt, you must add the file-type extension to a file name. The PC-8300 system checks the file-type extension and proceeds as outlined below:

1. When the specified external device type is "COM:", the file-type extension must be ".DO" (this means that it must be a document file)
2. If the file-type is specified as ".BA", then a BASIC program file in binary format will be loaded.
3. If the file-type is specified as ".DO", a TEXT file or a BASIC file in ASCII format will be loaded.
4. If the file-type is specified as ".CO", a machine language file is loaded.

## 5.2 SAVE f.2

### FUNCTION

The SAVE command saves a file from the current RAM memory bank to the specified external device. The specified device could be a data recorder, a Micro Disk Drive Unit, or a serial device connected to the RS-232C port of the PC-8300. The RAM bank from which the file is stored is the bank you selected.

### OPERATION

1. Connect the necessary external device properly.
2. Turn on the external device and the PC-8300.
3. In the MENU mode, select the bank by pressing f.10 (see BANK command).

You can see the bank number in the upper right corner of the MENU screen.

4. Move the directory cursor onto the file name you want to save. For example if you want to save the file "SCHDL.BA" to a cassette tape move the directory cursor over it like on the following screen:

1986/12/01	14:18:25	(C)Microsoft #1	
BASIC	TEXT	TELCOM	LETTER.DO
SAMPLE.DO	ADDR.DO	CALC.BA	<b>SCHDL.BA</b>
.-	.-	.-	.-
.-	.-	.-	.-
.-	.-	.-	.-
.-	.-	.-	.-
Load	Save	Name	List 25496

5. Press f.2. You will see the message on the last line like this:

Save SCHDL.BA as _
--------------------

6. This prompt is asking you to specify the name of the external device and the file name you want to save. Here for example, we assume to save a document file named "SCHDL" onto the cassette tape (refer to the next section about the other devices and other type of files).

Type

**SCHDL**

or

**CAS:SCHDL**

and press .

Or just press  only.

"CAS:" is the device name for cassette tape, and it can be omitted. And if it is not necessary to change the file name from the one in RAM bank, you don't have to specify the file name either.



Files on the cassette tape don't have to have file extensions.

7. In this example you selected a BASIC program files. There are two formats for saving a BASIC program to external devices other than RS-232C devices. The next prompt is asking you which format you want to save the file in, binary format or ASCII format.

B(inary) or A(ascii)? \_



In binary format, the file will be saved in the BASIC intermediate code and it is shorter than the ASCII format.

In ASCII format, BASIC programs will be saved in the same format as document files, so they can be read as data files, but the files will be longer because each character comprising the program will be saved as an ASCII character.

For the example, type in **B** (for Binary) or just press  (binary is the default setting).



8. The next prompt is asking you if you have set the device, in this case setting the cassette tape, by pressing the PLAY and REC button. If you are ready, type Y or just press .

Ready? \_

Refer to Chapter 6 for details about using cassette tapes and a data recorder.

9. When saving is successfully completed the last line of the MENU screen will return to the function key commands display.



If you want to interrupt saving in the middle of the saving process, press  .

### 5.2.1 Device Name and File Name (to the "Save filename as" Prompt)

You have to specify the device name and file name to the "Save as" prompt like you do to the LOAD "Load from" prompt.

#### ***device-name:filename***

The possible *device-names* are

no device-name	default is cassette tape
<b>CAS :</b>	cassette tape
<b>COM :</b>	device connected to the RS-232C port

The file name can be omitted when the device-name is "CAS". And the name of the file on the cassette tape will be the same as the file in the RAM bank.

For example you select the file named "SAMPLE.BA" and type only **CAS :** and press  or no response entered to the "Save as" prompt, the file name on the cassette tape will be "SAMPLE". The files on the cassette tape have no extensions.

The *device-name* "COM:" designates a communication parameter instead of a *filename*. If the parameter is omitted, the current mode is retained.

A document file ".DO" and a BASIC program file ".BA" can be saved to any external devices, but a machine language file ".CO" cannot be saved to the RS-232C device.

The following chart shows the appropriate responses to the "Save as" prompt, the results of the response, the type of external device, and the resulting file name.

File Name Selected	Response to "Save filename as"	External Device	Resulting File Name
NOTE.DO	(no response entered)	Data Recorder	NOTE
	MEMO	Data Recorder	MEMO
	CAS:MEMO	Data Recorder	MEMO
	CAS:	Data Recorder	NOTE
	COM:8171XN	RS-232C Device	(8171XN)
	COM:	RS-232C Device	(Current mode)
MAZE.BA	(no response entered)	Data Recorder	MAZE
	DEMO	Data Recorder	DEMO
	CAS:DEMO	Data Recorder	DEMO
	COM:8171XS	RS-232C Device	(8171SX)
	COM:	RS-232C Device	(Current mode)
TEST.CO	(no response entered)	Data Recorder	TEST
	TEST1	Data Recorder	TEST1
	CAS:TEST1	Data Recorder	TEST1

## 5.3 NAME f.3

### FUNCTION

The NAME command changes a file name in the current RAM bank.

### OPERATION

1. Move the directory cursor over the name of the file to be renamed and then press f.3.
2. Type the new file name in response to the following prompt, where "xxxxxx.xx" in this case is the file name to be changed:

**NAME xxxxxx.xx as**

3. Type in a proper file name, press ↵ and the old name of the file will be changed to the new name. The new name will be displayed on the screen in place of the old name.

It is impossible to assign a file type such as ".DO", ".BA", or ".CO" when you are replacing an old file name with a new name. The new file will automatically assume the same file type extension as the old file.

A "BEEP" sound will be generated and the input will be rejected if one of the following has been entered:

1. If an attempt is made to designate a file name that is longer than 6 characters.
2. If you try to include a period or colon as part of the 6 character name.
3. If you assign an already existing name to a new file.

Most punctuation marks, other than the colon or period, may be used as part of a file name.

The PC-8300 will accept an identical file name for a new file if one file name is entered in upper case letters and the other in lower case letters.

If it becomes necessary to cancel a process while executing a file NAME command, you may perform one of the following procedures:

1. Press STOP.
2. Press CTRL C.
3. Press ↵ if the name you are assigning has not yet been input into the PC-8300.

## 5.4 LIST f.4

### FUNCTION

The LIST command outputs the contents of a file to a parallel printer.

### OPERATION

1. Connect your parallel printer to the PRINTER port on the rear of the PC-8300.
2. Turn your printer on and make sure it is on-line (NEC printers have a SElect switch to place the printer on-line).
3. In the MENU mode, select the bank in which the file you want to print out is stored by pressing f.10 (see details at the end of this chapter for BANK command). You can see the bank number in the upper right corner of the MENU screen.
4. Move the directory cursor over the file name you want to print out. Let us assume that you want to print out a file named "CALC.BA".

1986/12/01	14:18:25	(C) Microsoft #2		
BASIC	TEXT	TELCOM	LETTER.DO	
SAMPLE.DO	ADDR.DO	COSTS.DO	SCHDL.BA	
<b>CALC.BA</b>	--	--	--	--
--	--	--	--	--
--	--	--	--	--
--	--	--	--	--
Load	Save	Name	List	25496

5. Press f.4.



If you select a ".DO" file, you will see the message on the last line like this:

```
List With(80): _
```

This prompt is only displayed when you select ".DO" files.

Type in the appropriate printer width (greater than 9 but less than 133) and press ↵. You may press ↵ to use the default value displayed in the parentheses.



6. To the next prompt, type **Y** (for Yes) if the printer is properly set.

```
List filename Ready? _
```

Then your printer will begin to print out the file.

### Type of Files to Print Out by LIST Command

The LIST command is used for the files which have ".DO" or ".BA" extensions. If any other file is selected a beep sound will be generated and the input will be rejected.

### Interrupt Printing

When a malfunction does occur, or if you want to interrupt the printing, just press **SHIFT STOP**.

### Features

The LIST command has the following features when a file is being printed:

- (1) Automatic word-wrap — moves a word onto the next line when the word is going to extend past the margin setting.
- (2) Dropping the extra spaces at the beginning of lines

### Other Ways to Print Out

- (1) Document Created by the TEXT

It is recommendable to use the TEXT PRINT command to print out the document files created in the TEXT mode. It has more convenient features than the LIST command and you can also use a serial printer.

- (2) BASIC Program Files

You can use the BASIC LLIST command to print out BASIC program files. This command has almost the same function as the MENU LIST command but doesn't have the features of word wrapping nor of dropping the extra beginning spaces.

## 5.5 SETIPL **f.6**

### FUNCTION

The SETIPL command will load a predetermined set of instructions previously saved in a file, so that when the PC-8300 is turned on, these instructions will be automatically executed.

### FEATURES

An IPL command file contains a series of commands or information that would normally be input from the keyboard.

The purpose of using an IPL file is to save time by not having to repeat steps which are frequently needed. You can also use the IPL to protect your files from unauthorized use by using a log-on password.

### OPERATION

1. Move the directory cursor over the name of the file to be set as an IPL command file.
2. Press **f.6**
3. Turn off the power to the PC-8300.
4. Turn the PC-8300 back on, and the file you designated as the IPL command file will be executed.

### DESCRIPTION

Only a TEXT file with the extension ".DO" can be designated as an IPL command file. After the SETIPL command has been used, the IPL command file is displayed with the file-type extension "\*DO" when it appears in the MENU.

An IPL file can execute commands, or respond to commands with designated information. The three main commands that an IPL command file can execute as the first command are BASIC, TEXT and TELCOM, the file names of the three ROM-based software of the PC-8300.

Once one of these three modes has been entered by using an IPL command file, the commands specific to the chosen mode can be executed.

If an error occurs during the execution of these commands, the IPL file will interrupt its operation and display an appropriate error message. The program execution will be aborted, so the program lines following the line which contained the error will not be executed.



If an invalid file name is designated as an IPL file, a warning "BEEP" sound will be generated when the SETIPL function is executed.

If an IPL command already exists and you attempt to designate another file as an IPL command file, the original IPL command file-type will revert from "\*DO" to the ordinary TEXT file-type ".DO", thus allowing the new designation to be accepted.

Also such reversion to ordinary file-type will happen to the designated IPL command file when the CLR IPL command is used.

### A Sample IPL Command File

The PC-8300 can be used in the TEXT mode for taking notes during meetings. An IPL command file can be designated to perform the steps of entering the TEXT mode and opening the file to be used each time a meeting is attended.

In the MENU mode, move the directory cursor onto the word "TEXT" and then press . Type 'IPL.DO' as the filename in response to the prompt "File to edit?" and then press . Then type the following lines while in the TEXT mode:

TEXT 

MEMO.DO 



Notice that  is used to separate the command lines in an IPL command file.

An IPL command file can consist of up to 64 characters, with  being counted as two characters, for the carriage return and the line feed.

Now press  to save this file, and set "IPL.DO" to the IPL command file by using SETIPL command. The next time you turn on the PC-8300, the TEXT is always executed and "MEMO.DO" is opened automatically.

## An IPL Command File for Password Protection

In the MENU mode, select the TEXT mode, and then type "PASSWD.DO" for the file name in response to the prompt "File to edit?" Then type the following in the TEXT mode:

```
BASIC 
```

```
CLS: INPUT AS: IF AS<>"PC8300" THEN POWER OFF
```

```
ELSE MENU 
```

Now press  to save the file in RAM as "PASSWD.DO".

Now in the MENU mode put the directory cursor over the filename "PASSWD\*DO" and press . This will designate that file as the current IPL command file. Notice that its file-type extension changed to "\*\*DO".

Next, turn the power of the PC-8300 off, wait a few seconds, and turn it back on again.

You will see a question mark, which is prompting you to enter the password, so type in "PC8300", without the double quotation marks. This will permit you to continue, so you will see the MENU display.

If someone who does not know your password tries to use your computer, after you type the wrong word and when you press  (not "pc8300") the computer will turn itself off.

The password can be changed, and it is a good idea to use a long password and change it frequently, to avoid unauthorized people from guessing it.

## 5.6 CLR IPL

### FUNCTION

Clears an IPL command file.

### OPERATION

Press . This will cause the currently designated IPL command file with its file-type "\*\*DO" to revert to an ordinary TEXT file with the file-type extension ".DO".

```

1986/12/01 14:18:25      (C) Microsoft #2
BASIC          TEXT          TELCOM          LETTER.DO
SAMPLE.DO     ADDR.DO     PASSWD*DO     COSTS.DO
SCHDL.BA     CALC.BA     --            --
--            --            --            --
--            --            --            --
--            --            --            --
SetIPL  ClrIPL          Kill          Bank

```

## 5.7 KILL f.9

### FUNCTION

The KILL command deletes a file in the current RAM bank.

### OPERATION

1. Move the directory cursor over the file name to be erased and then press f.9.

For example:

To erase the file called "PC8300.DO":

```

1986/12/01 14:18:25      (C) Microsoft #2
BASIC          TEXT          TELCOM          LETTER.DC
SAMPLE.DO     ADDR.DO     PC8300.DO     CCSTS.DC
SCHDL.BA     CALC.BA     --            --
--            --            --            --
--            --            --            --
--            --            --            --
SetIPL  ClrIPL          Kill          Bank

```

2. The prompt "Kill PC8300.DO Sure?" will appear as shown below:

```

** Kill PC8300.DO Sure?

```

3. Type **Y** for "Yes", and the file will be deleted.

To cancel a "KILL" command, input any key other than "Y" or "y" in response to the prompt above.

Any file with the file-type extensor ".BA", ".DO" or ".CO" can be erased with this command.

Note that the three built-in commands BASIC, TEXT and TELCOM cannot be erased by the "KILL" command because they reside in the ROM.

After a file has been deleted, you can check that its file name no longer appears in the MENU.

1986/12/01	14:18:25	(C) Microsoft #2	
<b>BASIC</b>	TEXT	TELCOM	LETTER.DO
SAMPLE.DO	ADDR.DO	COSTS.DO	SCHDL.BA
CALC.BA	--	--	--
--	--	--	--
--	--	--	--
--	--	--	--
Load	Save	Name	List 25496

## 5.8 BANK f.10

### FUNCTION

The BANK command lets you switch between bank #1, #2 or #3.

### OPERATION

Press f.10 to change the current bank number which appears on the MENU screen.

Bank switching will occur in one of the sequences shown below depending on how many banks are available:

If there are only two banks, the BANK command will toggle between #1 and #2. This means that if #1 is the current bank, the BANK command will switch to #2, and vice versa.

If there are three banks, then the switching order is:

# 1 to # 2 to # 3 and back to # 1 in a circular sequence.

Internal RAM Banks

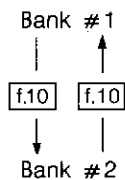

With RAM Cartridge

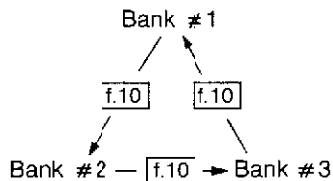

# CHAPTER 6

## PERIPHERAL DEVICES

---

<b>6.1 DATA RECORDER</b> .....	81
6.1.1 Connecting the Data Recorder PC-8281A .....	82
6.1.2 Preparing Cassette Tape and Data Recorder .....	83
6.1.3 Care and Handling of Cassette Tapes .....	84
6.1.4 Maintaining the PC-8281A Data Recorder .....	86
6.1.5 Troubleshooting .....	87
<b>6.2 PRINTER</b> .....	87
6.2.1 Connecting a Printer .....	88
6.2.2 Preparing a Printer .....	89
6.2.3 Printing out Your Data and Files .....	89
6.2.4 Printer Maintenance .....	90
6.2.5 Troubleshooting .....	91
<b>6.3 DEVICES FOR TELECOMMUNICATIONS</b> .....	93
6.3.1 Purpose of Telecommunications .....	93
6.3.2 Connecting the Optional Modem Card .....	93
6.3.3 Using the RS-232C Serial Port .....	96
6.3.4 Operating with an External Modem .....	99
6.3.5 Troubleshooting .....	100



<b>6.4 RAM CARTRIDGE</b> .....	102
6.4.1 Connecting and Disconnecting the RAM Cartridges .....	102
6.4.2 Power Supply for the RAM Cartridge .....	105
6.4.3 Operating the RAM Cartridges .....	105
6.4.4 Memory Protection .....	106
6.4.5 Battery Information .....	107
6.4.6 Troubleshooting .....	109
<b>6.5 DISK DRIVE</b> .....	109
6.5.1 Introducing the PC-8231A Micro Disk Unit and the Micro Floppy Disk .....	110
6.5.2 The Micro Floppy Disk .....	112
6.5.3 Connecting the Disk Unit .....	113
6.5.4 Operating the PC-8231A Micro Disk Unit .....	115
6.5.5 Booting the Disk Code .....	118
6.5.6 Operating the PC-8300 MENU with the Disk Unit .....	119
6.5.7 Operating N82-BASIC with the Disk Unit ..	121
6.5.8 Care and Handling of Micro Floppy Disks .....	122
6.5.9 Maintaining the Micro Disk Unit .....	124
6.5.10 Troubleshooting .....	125
<b>6.6 OTHER PERIPHERAL DEVICES</b> .....	126

Although the PC-8300 is a portable, full-performance, productivity tool, when used with its family of peripherals, it can perform satisfactorily as a desktop-dedicated unit.

As you saw in Chapter 1, the PC-8300 has many compatible peripherals, such as printers, data recorders, Expansion RAM Cartridges, Micro Disk Units, CRT monitors, bar code readers, Modem Cards, and other external devices which use the RS-232C serial interface.

This chapter introduces the step-by-step procedures to hook up these peripheral devices.

The use of these peripheral devices is explained in conjunction with the use of the built-in software, so please refer to the appropriate software manual or the relevant sections of this guide.

## **6.1 DATA RECORDER**

Cassette tapes are the cheapest external storage media for computers. You can use an ordinary audio cassette tape with almost any make of cassette tape recorder connected to your PC-8300 through the REMOTE port, using the appropriate jacks. Some tape recorders have different type of jacks from the ones for the CMT (Cassette Magnetic Tape) cable of the PC-8300.

NEC recommends the Battery-Operated Portable Data Recorder PC-8281A\* for use with the portable computers. The PC-8281A is specially designed for use as an external storage device for use with computers. It has a monitor function (the data is saved on tape as audio signals) and a beginning-of-file function to search for a file saved on tape.

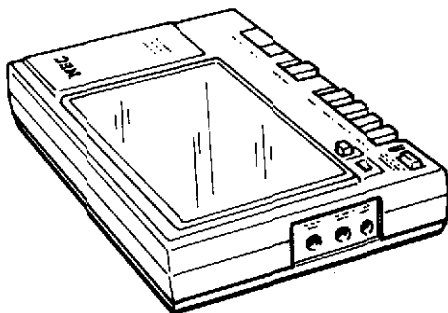

**Data Recorder PC-8281A**

When you fill the internal RAM bank of the PC-8300 with files, a data recorder is a handy peripheral to have. You can copy important files stored in the PC-8300 internal RAM to the cassette tape. You can then erase them from the internal RAM to make room for new files.

In addition, saving files to a data recorder enables users to exchange programs and data files between PC-8300's.

Periodically storing important files to an external storage device, like a data recorder, can protect them from being lost by accidental erasure.

\* The PC-8281A Data Recorder is used as an example in this section.

### 6.1.1 Connecting the Data Recorder PC-8281A

The PC-8300 has a data recorder interface for program and data file storage with a speed of 500 baud (bits per second).

To connect a PC-8281A data recorder to your PC-8300, follow these simple steps.

1. Check to make sure that the PC-8300 power switch is turned off.
2. Plug each of the three male plugs of the CMT Cable (included in the PC-8300 box) into the appropriate jacks on the side of the PC-8281A data recorder as shown in the figure below.

The REMOTE jack allows the PC-8300 to automatically turn the PC-8281A on or off.

The CMT OUT jack sends the data to the PC-8300.

The CMT IN jack receives data from the PC-8300

3. Plug the other end of the CMT Cable into the round interface port labeled "CMT" on the right rear side of the PC-8300. Make sure that the notch on the connector is facing up when inserting it into the CMT interface.

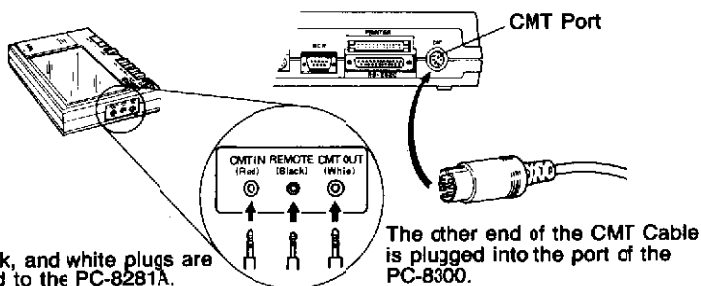

- To use electrical power from your main power supply, plug the data recorder into its AC adaptor, which is connected to a wall electrical outlet.

Now the connection between your PC-8300 and the PC-8281A is complete. Next, prepare your PC-8300 and PC-8281A to load and to save files.

## 6.1.2 Preparing Cassette Tape and Data Recorder

- Turn on the power of the PC-8300 and the PC-8231A.
- When loading a file from cassette tape to the PC-8300, set the volume using the volume control on the PC-8281A.  
When saving a file to cassette tape, the PC-8281A automatically adjusts itself to the best level for recording; however, if you use some other tape recorder, it will be necessary for you to find the best level for recording (saving) files. Try adjusting the volume a little at a time, until you find the best recording level. This may take quite a bit of experimenting.
- Saving files to tape or loading files from tape.

Make sure that you are using the correct side of the tape.



When saving files, make sure to move the tape forward past the black leader portion, because if you try to record on this part you will lose part of your program.

- Reset the counter to 000 to note the number of the location where you store the programs on the tape.

Now you can begin to load from tape, or save files onto tape by using the features of MENU or BASIC:

**MENU mode:** BASIC program files (BA files),  
BASIC data files (.DO files),  
machine language files (.CO files),  
TEXT document files (.DO files),  
are loaded by the LOAD command (**[f.1]**), and are  
saved by the SAVE command (**[f.2]**).

- BASIC mode:** BASIC program files are loaded and saved by the LOAD, CLOAD, SAVE, and CSAVE commands.
- Data is written into or read from BASIC data files by the use of the OPEN, INPUT #, PRINT #, CLOSE instructions (and some other), written into programs.
- Machine language files are loaded and saved by using BLOAD and BSAVE commands.

If you're not a BASIC programmer, it is recommended that you operate a Data Recorder in the MENU mode, in which you need only follow the prompts from the MENU.

For more detailed information on the use of the commands, please refer to Chapter 5 MENU Commands and the appropriate pages in the N82-BASIC Reference Manual.

## 6.1.3 Care and Handling of Cassette Tapes

### Audio Tapes

Audio tapes are standard cassette tapes used with stereo tape players. In order to "write protect" files stored on a cassette tape, remove the tabs from the back of the cassette; this will prevent overwriting of the files, which would replace them with new files. Remove the tab carefully, as illustrated below, without cracking or damaging the cassette itself.

When the cassette tape is held flat with the open side facing away from you, the write-protect tab for the side facing up is on the right. The illustration shows the tab for Side A being removed in order to provide write protection.

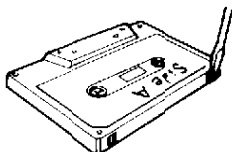

To write new information to a write-protected tape, you must first remove the write-protection (enable writing to the tape); you do this by covering the write protect tab area with a piece of cellophane tape. Now you will be able to record new files over those already on the tape.

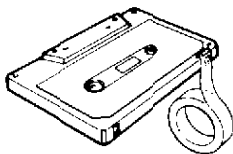

For best results, use the best quality, high-bias cassette recording tape available. Often you will be storing valuable information on cassette tapes, which you do not want to lose, so it is not wise to use low-quality tapes.

Follow the manufacturer's recommendations regarding care, ambient temperature and storage of cassette tapes.

A few additional recommendations:



- Never touch the magnetic surface of the tape. Handle the tape by its plastic case only.



- Always insert the tape into the data recorder with the magnetic surface facing the front of the unit. Gently place the cassette tape into its seating. Never try to force it into place.

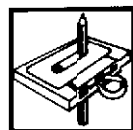

- The tape should be tightly wound in the cassette at all times. If it is loose, place a pencil into the play reel (not the take-up reel!) and slowly tighten the tape by turning the pencil clockwise.

## Digital Tapes

Digital tapes are specially made for storing data. They have write-protect tabs that slide or flip into and out of place to turn the write-protection feature on or off.

Refer to the manufacturer's instructions for the proper method of write-protecting each make of cassette tape.

### 6.1.4 Maintaining the PC-8281A Data Recorder

Your PC-8281A Data Recorder requires only minimal maintenance. However, for optimal performance, you should periodically clean the recording heads. The easiest way to do this is with a head cleaning tape. You can buy this type of tape from an audio component supply house or a stereo store. Directions for using these tapes are supplied with the tape.

If you do not have a head cleaning tape, follow the instructions below to maintain your data recorder's high performance.

1. Open the cassette tape door by pressing the STOP/EJECT button.
2. Gently clean the surface of the heads and capstan with a cotton swab dipped in rubbing alcohol.

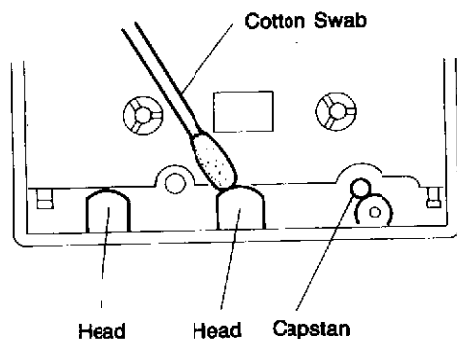

3. Use a clean dry cotton swab to gently dry the surfaces.
4. Wait five minutes after drying before inserting a tape, to make sure that all the alcohol has evaporated.

## 6.1.5 Troubleshooting

If the PC-8281A Data Recorder does not operate properly, check these items.

- Is the PC-8281A Data Recorder properly supplied with power? It should be either plugged into a mains power outlet via its AC adapter, or it should have four new AA type batteries inserted properly in its battery case.
- Is the CMT Cable correctly connected to the PC-8281A and the PC-8300?
- Is the LOAD button correctly pressed down when you try to load files into the PC-8300 from the PC-8281A?
- Are the LCAD and SAVE buttons correctly pressed down when you want to save files from the PC-8300 onto cassette tape?
- Is the load-level indicator on the center position or above when loading files into the PC-8300 from cassette tape?
- Are you trying to save files to a cassette tape that has been write-protected?
- Is the cassette tape defective? Have you tried another tape?

If you've checked all the above items and the PC-8281A data recorder still isn't working properly, contact your nearest NEC Dealer or NEC service offices (listed in Appendix I).

## 6.2 PRINTER

The PC-8300 can operate with practically any printer. It has a parallel (Centronics compatible) interface and a serial (RS-232C) interface, so it can be used with both parallel and serial printers.

If you already own a printer, the PC-8300 will probably work with it.

If you need to buy a printer, the selection of printers on the market is large and varied. Your selection of a printer should be dependent on your needs and your budget. Please check with the shop where you purchased your PC-8300.



## 6.2.1 Connecting a Printer

To connect a printer, please follow the simple steps below:

### A Parallel Printer

You need the PC-8300, a printer, and a Printer Cable

1. Place your printer near the PC-8300.
2. Make sure the power switches of the printer and the PC-8300 are turned off.
3. Connect the small end of the Printer Cable to the parallel printer port labeled **PRINTER** on the rear of the PC-8300.
4. Connect the large end of the printer cable to the parallel interface on your printer.

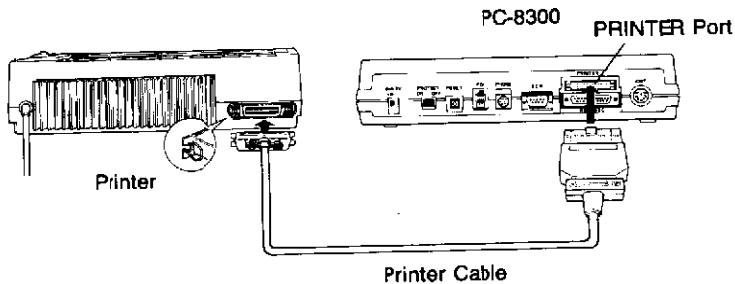

5. Turn on the power of the PC-8300.
6. Turn on the power of the printer.
7. Make sure your printer is in the on-line mode (many NEC printers have a **SELect** button to switch between the on-line and off-line modes).

### A Serial Printer

You need the PC-8300, a serial printer, and an appropriate RS-232C cable.

Follow the same steps above except using an RS-232C cable connected to the RS-232C port on the rear of the PC-8300.

## 6.2.2 Preparing a Printer

There are many types of printers available on the market, so we will not even attempt to explain the procedure needed to use each one. However, the following will give you enough information to be able to use most printers. You will also need to refer to the manual of your printer, especially for the unique features and codes used for its control and operation.

1. Install the ink ribbon properly in your printer. Most printers need a ribbon, but some thermal printers don't. Laser printers require only toner.
2. Set the dip switches of your printer according to your printer's manual. Some printers have switches which are used to select modes. In most cases, however, the default setting of these dip switches can be used.
3. Install a sheet feeder for the paper when necessary. Some printers are designed to take an optional sheet feeder.
4. Load paper. Every printer needs to have paper loaded, either into a sheet feeder, to have continuous paper set on a tractor feeder, or to have paper hand-fed, sheet by sheet.
5. Before use, close the canopy and all other parts of the printer that you opened.
6. If your printer has a self-test function, run it.

## 6.2.3 Printing out Your Data and Files

You can print out your data from the MENU mode, the BASIC mode, the TEXT mode, or the TELCOM mode.

This section explains the procedure needed to print out in each mode.

**MENU mode:** The MENU mode has a LIST command (`f4`), which will list files which are in the RAM bank and print them on your parallel printer. Place the directory cursor onto the file name of the file you want to print out, and then press `f4`. Refer to Chapter 5 for more detail of the LIST command.

**BASIC mode:** BASIC includes some instructions to control the parallel PRINTER port and the RS-232C serial port, so you can use both parallel and serial printers.

If your printer is parallel, please see the details of the LPRINT and LLIST instructions in the N82-BASIC Reference Manual.

If your printer is serial, please see the details of the OPEN"COM": and PRINT# instructions in the N82-BASIC Reference Manual.

**TEXT mode:** TEXT is a powerful word processor. You can print our your documents with a beautiful layout to both parallel and serial printers. Please read the TEXT Manual for details.

**TELCOM mode:** TELCCM is a telecommunications tool using the RS-232C serial port. If your printer is serial you can use TELCOM's UPLOAD command to print your file. Check your TELCOM Manual for the correct settings of the telecommunications parameters.

## 6.2.4 Printer Maintenance



- Don't use the printer without a ribbon because you might damage the print head.

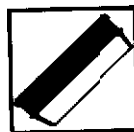

- Use the ribbon cartridge designated for your particular printer.



- Replace the ribbon before it wears all the way through or you might damage the print head.



- Don't place foreign materials (clips, pins, liquids, etc...) where they may fall into your printer.



- Don't use detergents or solvents to clean the mechanical parts of your printer.
- Use only a damp cloth to clean the cover.



- Follow all precautions described in the manual of your printer.

## 6.2.5 Troubleshooting

1. If the printer does not operate, check these items:

- Is the power indicator light on?  
If not, make sure the printer is properly plugged in and the power is turned on.
- Is the ON-LINE (select) indicator light on?  
If not, push the ON-LINE select button.

2. The print head moves but nothing is printed

OR

the characters are blurred

OR

some characters are not printed.

- Is the ink ribbon installed correctly?  
If not, reinstall it correctly.
- Is the ink ribbon too old?  
If so, install a new one.

3. Paper is not fed when the paper feed button is pushed.
  - Is the power indicator light on?  
If not, make sure the printer is properly plugged in and the power is turned on.
  - Is the select indicator light on?  
If it is on, press the online (select) button to go to the offline mode.
  - Is the paper inserted correctly?  
If not, adjust the paper.
4. The printer prints a test printout without a problem but it will not print files from the PC-8300.
  - Are you using the correct cable?  
If not, contact the shop from which you purchased it or your nearby NEC agent to obtain the correct cable.
  - Is the cable connected to the PC-8300 and the printer correctly?  
Check the connection procedures in Chapter 6.2.1.
  - Is the correct printer interface selected, parallel or serial, as outlined in Chapter 6.2.3?
5. The printer prints a document from the TEXT mode, but the document is improperly formed or the characters are somehow incorrectly printed.
  - Did you select the correct printer from the printer selection list in the TEXT program as outlined in the TEXT manual?
  - If you are using a serial printer, did you enter the correct communications parameters for your printer as given in your TEXT manual?

If you've checked all of the above items and your printer still isn't working properly, contact the nearest NEC service offices from among those listed in Appendix I.

## **6.3 DEVICES FOR TELECOMMUNICATIONS**

### **6.3.1 Purpose of Telecommunications**

With the increase in the number of electronic data services available to subscribers today, more and more, personal computer purchasers are considering the telecommunications capability of a personal computer as an important factor in deciding what kind of computer to buy.

Many owners of portable computers have made their purchase for the primary purpose of telecommunications. They've found that portable computers allow them the flexibility of transmitting or receiving data anywhere at any time. No longer are they tied to their office to wait for access to a company mainframe or a main electronic database.

The NEC PC-8300, as a portable personal computer, is the perfect example of this new breed of computer. The PC-8300, with its built-in telecommunications software, terminal emulation capabilities, standard RS-232C interface, and optional 300 baud Modem Card that can be installed into the PC-8300 body, is the perfect portable data communications terminal. These hardware and software features combine to give the PC-8300 user easy access to electronic data services and databases, to other personal computers, and easy transfer of information directly to other personal computers through cables via the RS-232C interface, or even access to standard mainframe computers.

The optional 300 baud Modem Card has autodial capabilities.

This section includes information on using the optional 300 baud Modem Card, and accessing the RS-232C interface.

Please refer to the TELCOM Manual for information regarding the built-in TELCOM telecommunications utility.

### **6.3.2 Connecting the Optional Modem Card**

One of the most outstanding features of the PC-8300 is the optional 300 baud Modem Card. When used with the powerful, built-in TELCOM telecommunications utility, data transfer to and from the PC-8300 is easy, fast and efficient.

Follow the simple steps below to connect the PC-8300 to your telephone system.

Refer to the TELCOM Manual for instructions on data transfer.

1. To operate the PC-8300 with the optional 300 baud Modem Card, the minimum hardware requirements are:
  - (1) A PC-8300
  - (2) A PC-8361A 300 baud Modem Card
  - (3) A telephone connected to a telephone system with a cable that uses RJ11 modular plugs and connectors
  - (4) A PC-8399A-02 Phone Cable which is supplied in the box with the PC-8261A
2. Make sure that the power of the PC-8300 is off.
3. Remove the lid for the Modem Card on the bottom of the PC-8300 by using a screwdriver.

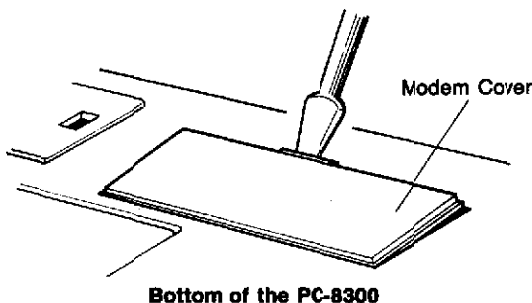

4. Install the PC-8361A Modem Card into the PC-8300 by following the Instruction Guide that is included in the PC-8361A packing box.

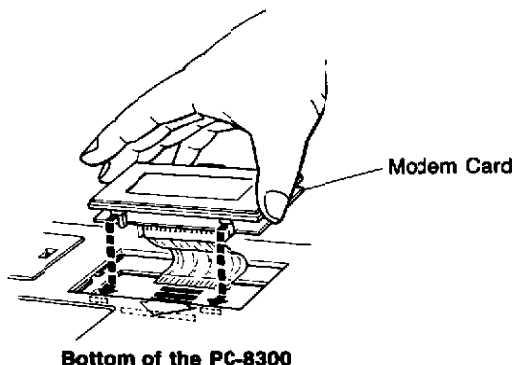

5. Connect the round end of the Phone Cable included in the PC-8361A packing box into the PHONE port on the rear of the PC-8300.

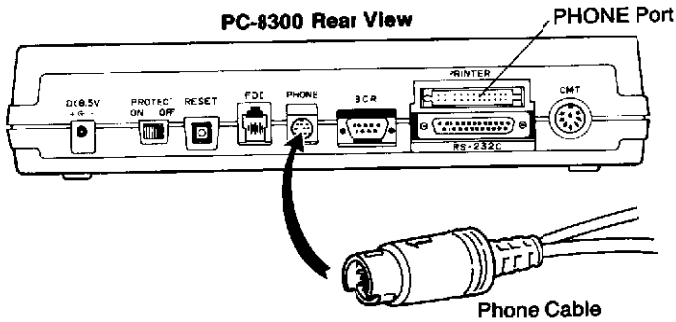

6. Disconnect the telephone from the telephone system by removing the male RJ11 connector from the rear of the telephone.

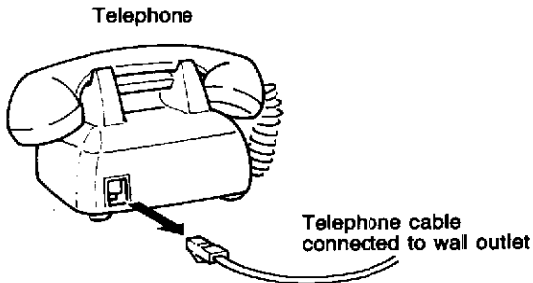

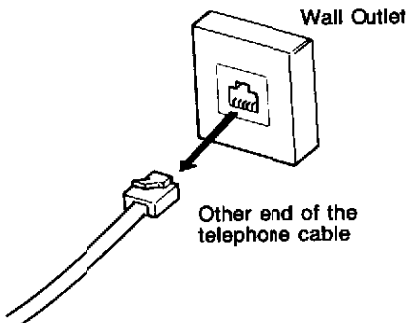

7. Disconnect the RJ11 cable from the wall outlet.



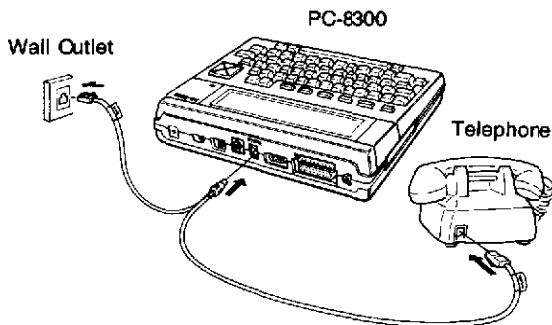

8. Connect the end of the Phone Cable labelled "TELEPHONE" to the telephone, and the other end labelled "LINE" to the wall outlet.



9. Turn on the power of the PC-8300 and start the TELCOM program by placing the directory cursor over the name TELCOM and pressing .
10. Set up the data communication parameters required by the host computer. Continue data transfer according to the instruction in the TELCOM Manual.

### 6.3.3 Using the RS-232C Serial Port

The PC-8300 can communicate with practically any other computer, either directly or through a modem. This section will describe how to connect the PC-8300 directly, without the need of a modem, to other computers, or to any other devices that have an RS-232C serial port.

#### A. Other personal computers

The concept of the PC-8300 portable computer is that of a stand-alone, portable, high-productivity tool. In addition, the PC-8300 was designed to act as a desk-top personal computer while using the peripherals available in the computer series. While the PC-8300 computer and its peripherals should normally be adequate for most data processing needs, it may be necessary or desirable to transfer data from the PC-8300 to another personal computer for processing in another environment.

The builtin TELCOM program of PC-8300 is a powerful telecommunications utility to support file transfer. The hardware and software requirements for each combination depend on the data transfer functions and facilities of the other personal computers involved. The most common steps are introduced below.

1. The hardware requirements for connecting a PC-8300 and another personal computer are:
  - (1) A PC-8300
  - (2) A personal computer that has an RS-232C serial interface and an RS-232C connector (Some computers need the installation of an optional RS-232C interface unit. Be sure that your other computer already has the required capability for the RS-232C interface.)
  - (3) An RS-232C reverse cable that has a connector compatible with the other personal computer and with the PC-8300  
(NEC provides the reverse RS-232C Cable for data transfer with NEC PC-8801A, PC-8500, PC-8401A, PC-8201A and other personal computers that have a compatible RS-232C serial interface and a compatible connector.)
2. Make sure the PC-8300 and the other personal computer are both turned off.
3. If the RS-232C interface which you want to use on the other personal computer is an option and if it is a board or some additional hardware, install it correctly into the personal computer by following the instructions which come with it.
4. Connect one end of the RS-232C Cable to the RS-232C port on the rear of the PC-8300. Connect the other end of the RS-232C cable to the RS-232C port on the other personal computer.

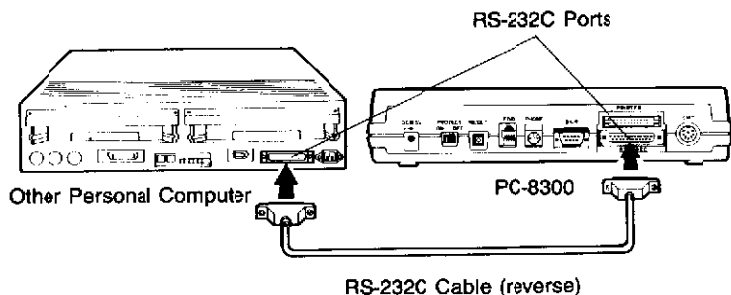

5. Turn on the power of both of the computers and start running the telecommunications utilities on each side.  
(Start TELCOM on the PC-8300. You could also write a controller program using N82-EASIC.)

## **B. Other RS-232C equipment**

Since the PC-8300 has a standard RS-232C interface, it can be used as a controller for equipment that has an RS-232C interface. Here we introduce a set of simple steps to connect the PC-8300 with a serial printer as an example.

1. The minimum hardware requirements for connecting a PC-8300 to a serial printer are:
  - (1) A PC-8300
  - (2) A serial printer that has an RS-232C serial interface
  - (3) An RS-232C Cable
2. Make sure the power of the PC-8300 and the serial printer is turned off.
3. Connect one end of the RS-232C Cable to the RS-232C port on the rear of the PC-8300, and the other end of this cable to the RS-232C port on the serial printer.
4. Turn on the serial printer.
5. Turn on the PC-8300, and start running the communications utility.
6. Before transmitting the data, make sure to set the communications parameters correctly, referring to the manual of the serial printer. You can set the communications parameters from the TELCOM mode, from the TEXT mode, or from the BASIC mode.
7. When you want to print out your .DO files (TEXT files or documents) using the TEXT mode, you should use the PRINT command of the TEXT mode. In other cases (such as when you want to print out the .DO files you created using BASIC, it is convenient to use the UPLoad command of TELCOM.

From BASIC you can also transfer data to a serial printer by using a data transmitting program.

In the above example, we used a serial printer with which the use of TEXT and TELCOM are the most common. In other cases, such as when you want to control the RS-232C units by receiving and transmitting data, you can do it by writing an appropriate program in BASIC.

### **6.3.4 Operating with an External Modem**

The PC-8300 can communicate with a variety of external modems. The selection of a modem depends on the requirements of the user.

1. The minimum hardware requirements for connecting the PC-8300 with an external modem are:

- (1) A PC-8300
- (2) An external modem of your choice
- (3) A PC-8495A-01 RS-232C Cable (normal). Some modems require a specific cable. Check the owner's manual of the modem for this information.
- (4) A telephone connected to the telephone system.

2. Telecommunications devices are generally classified into two categories, direct connect or acoustic couplers.

The method of connecting either type of device to the PC-8300 should be basically the same. Simply attach one end of the RS-232C Cable to the RS-232C port on the back of the PC-8300 and the other end of the RS-232C Cable to the RS-232C port on the modem or acoustic coupler.

3. When using a direct connect modem:

- A. You must use a telephone that uses modular connectors. First, disconnect the telephone from the telephone system by removing the male RJ11 jack from the back of the telephone.
- B. Connect the telephone system cable that was just disconnected from the telephone to the appropriate port on the modem.
- C. Some modems require the telephone to be connected to the modem also; if the one you have is this type, connect the telephone to the modem by the appropriate cable which should be provided with the modem.

4. If using an acoustic coupler:

Connect the telephone receiver to the acoustic coupler according to the instructions given in the owner's manual.

5. Turn on the power of the modem, or the acoustic coupler.

6. Turn on the power of the PC-8300 and start the TELCOM program by placing the directory cursor over the name TELCOM and pressing 

7. Set up the communications parameters as required by the modem and the host computer. Refer to the PC-8300 TELCOM Manual for instructions.

8. Use the PC-8300's keyboard or the telephone to dial the telephone number of the host computer; your choice of which to do depends on the modem's capabilities. Refer to the owner's manual of the modem for this information.

Due to the variety of telecommunications devices, both direct connect modems and acoustic couplers, the steps given here are general guidelines to follow for this type of data communications operation.

Continue the data communications session while following the instructions in the PC-8300 TELCOM Manual.

### **6.3.5 Troubleshooting**

1. If the PC-8300 does not operate properly when using the PC-8361A Modem Card, check these items.

- Is the telephone properly connected to one end of the cable labeled "TELEPHONE"?
- Is one end of the cable labeled "LINE" properly connected to the wall outlet?
- Are the communications parameters entered correctly?

2. If the PC-8300 does not operate properly when performing compute-to-computer operations, check these items.
  - Are you using the correct cable?
  - Is the cable properly connected?
  - Are the communications parameters entered correctly?
  - Are the communications parameters correctly set up on the other computer?
  - Are you using the correct software on the other computer?
3. If the PC-8300 does not operate properly when using an external modem, check these items.
  - Are you using the correct cables?
  - Are the cables properly connected?
  - Are the communications parameters entered correctly?
  - Is the power to the modem turned on?
4. If the PC-8300 does not operate properly when auto dialing, check these items.
  - Is the Phone Cable properly connected?
  - Is the telephone in good working order?
  - Is the pulse dial rate set correctly using the SETUP command in the TELCOM program?
  - Is pulse dialing compatible with your telephone system?
  - Is the telephone number entered correctly in the directory file?

If you've checked all of the above items and the PC-8300 still isn't working properly, contact your NEC Authorized Dealer or contact your nearby NEC agent, listed in Appendix I.

## **6.4 RAM CARTRIDGE**

The PC-8206A 32K RAM Cartridge and the PC-8207A 32K × 4 RAM Cartridge are portable external storage devices for use as additional memory banks of the PC-8300. They can be used in much the same way as floppy disks, since they can be removed from the PC-8300 and put in storage with data on them. Because they operate on a lithium battery and weight so little, RAM cartridges are much more convenient storage devices for a portable computer such as the PC-8300.

Besides their portability, the RAM Cartridges have other advantages as data storage devices. The RAM Cartridges access data very quickly — almost as instantaneously as the PC-8300 internal RAM bank. They're much faster than floppy disks which have to be accessed by the disk drive. Their independent power source and small size enhance portability. Their operation is quiet. Servicing the RAM cartridges is usually unnecessary because they have no mechanical or moving parts.

Also, since there is no limit to the number of RAM cartridges you may use, you have limitless data storage capacity, just like with disks.

### **6.4.1 Connecting and Disconnecting the RAM Cartridges**

The procedure for connecting and disconnecting the two kinds of RAM cartridges is exactly the same. Follow these steps:

#### **Connecting the RAM Cartridges**

The RAM Cartridges PC-8206A and PC-8207A are shipped with a plastic insulating plate inserted between the lithium battery and one of the battery contacts. It must be removed before the RAM Cartridge will work properly.

To remove the insulating plate, open the battery access cover on the bottom of the RAM Cartridge. Gently pull the insulating plate out from between the lithium battery and the contact.

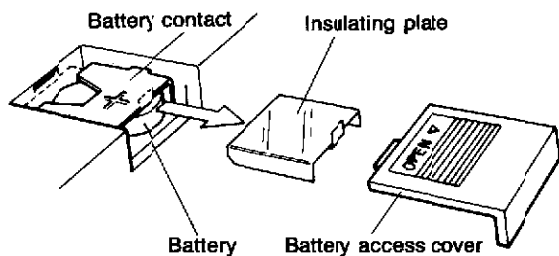

Close the battery access cover. Now the RAM Cartridge is ready for insertion.

To insert the RAM Cartridge, follow these steps.

1. Make sure the power of the PC-8300 is turned off.
2. With a ball-point pen or a screwdriver, remove the connector cap from the connector of the RAM Cartridge.

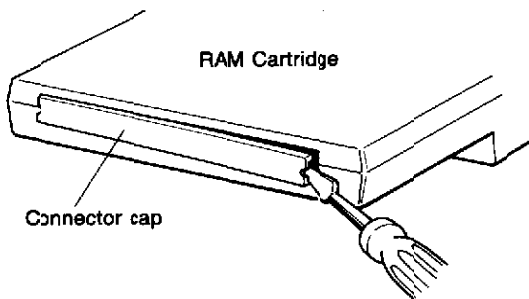



3. Insert the RAM Cartridge firmly into the system slot of the PC-8300 as shown below.

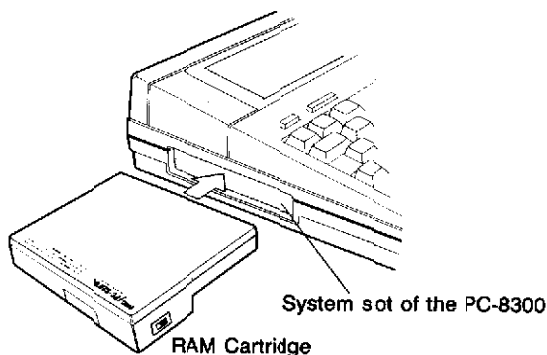

4. Turn the power of the PC-8300 on.

### **Disconnecting the RAM Cartridge**

To disconnect the RAM cartridge, follow these steps.

1. Make sure the power of the PC-8300 is turned off.
2. Grasp the RAM Cartridge firmly and pull it straight out from the PC-8300 system slot.
3. Put the connector cap back on the RAM Cartridge for safety.



If the RAM Cartridge is connected or disconnected from the PC-8300 when the power is on, both the RAM Cartridges and the PC-8300 may be damaged.  
Data stored on the RAM Cartridge may also be damaged.



Don't touch the connectors of the RAM Cartridge or the PC-8300. This may cause malfunctions.



Before installing or using the RAM Cartridges, read the instructions provided with them.

## 6.4.2 Power Supply for the RAM Cartridge

While a RAM Cartridge is disconnected from the PC-8300, or while the power to the PC-8300 is turned off with a cartridge installed, the lithium battery within the RAM Cartridge powers the circuitry to save files on the cartridge.

The PC-8300 consumes more power when a RAM Cartridge is used with it. This is because the power supply in the PC-8300 must also power the circuitry in the RAM Cartridge.

## 6.4.3 Operating the RAM Cartridges

After connecting the RAM Cartridge, a third RAM memory bank (bank #3) is available. In fact, the PC-8207A has four 32K RAM areas, and you can choose which one to use as the current bank #3. Only three banks can be accessed at one time.

### Selecting a 32K Block of the PC-8207A as Bank #3

The PC-8207A consists of 4 x 32K byte RAM areas. You can select one of these four blocks as bank #3 by setting the BLOCK switch on the side of the PC-8207A.

Follow these steps:

1. Turn the PC-3300 off if the PC-8207A is connected to it.
2. Set the BLOCK switch to the number you want to select.

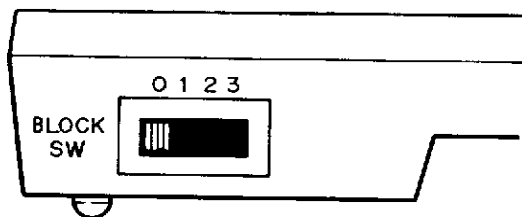

**BLOCK switch on the side of the PC-8207A**

3. Make sure that the PC-8207A is connected to the PC-8300.
4. Turn the PC-8300 on.

 The PC-8300 recognizes the selected block of the PC-8207A when it is turned on, so if you change the BLOCK switch setting while the PC-8300 is on, you can't switch the block.

### Initializing Bank #3 by a Cold Start

The first time you use the RAM Cartridge, and later, when you want to initialize the RAM (to clear it of your unwanted files, you should perform a cold start on bank #3.

 If you have forgotten to replace used batteries in your RAM Cartridge, and your files stored there are damaged or lost, replace the batteries with new ones and perform a cold start.

1. Turn on the PC-8300. If you aren't in the MENU mode, exit to the MENU mode by using the appropriate command for the software you are currently using.
2. Select bank #2 by using [f.10] BANK command. (hold [SHIFT] press [f.5])
3. As soon as you release the [f.5], and while still holding [SHIFT] down, press [CTRL].
4. For the PC-8207A, turn off the PC-8300, switch to another memory block, and repeat the procedure described above for each block.

Now you can access bank #3 exactly the same as the other two banks, #1 and #2.

### 6.4.4 Memory Protection

Just like the PC-8300 has a PROTECT switch for internal bank #2, the PC-8206A also has a PROTECT switch to inhibit writing to and reading from its memory. Use this PROTECT switch (set it to ON) to protect your valuable files stored on a PC-8206A.

Although the PC-8207 RAM Cartridge (32K x four blocks) has no PROTECT switch, the currently unselected three blocks are automatically protected, while the selected bank is vulnerable.

While a bank is protected, it cannot be selected from MENU by the BANK command.



Don't change the PROTECT switch setting (on the PC-8300 or the PC-8206A) while using bank #3, unless the PC-8300 doesn't work properly. If you make a mistake by doing this, it will probably result in some malfunction; if this happens, try turning off the PC-8300, set the PROTECT switch off again, and turn on the PC-8300.

## 6.4.5 Battery Information

### Battery Life

The PC-8206A and PC-3207A RAM Cartridges operate on Lithium CR-2032 batteries which should last approximately six months. It is advisable to replace it every six months, even though the RAM Cartridges seem to be functioning normally.

### Replacing the Battery

To make sure that you know when you last replaced the battery, you should write the date a new battery was inserted into the RAM cartridge on a label and stick this to the cartridge. Replace the battery when the due date approaches.

You can replace the battery without losing the files stored on the RAM Cartridge. First, remove the RAM Cartridge from the PC-8300. Then, plug the PC-8271A-01 AC Adapter into the adapter jack on the side of the RAM Cartridge and plug it into a wall power outlet.

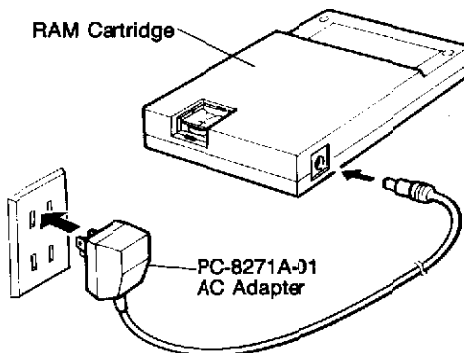

To replace the battery, open the battery access cover on the bottom of the RAM Cartridge. Pull the battery out from under the contact. Place the new battery in under the contact. Make sure that the battery is facing the correct way and the polarity is correct. Positive should face up.

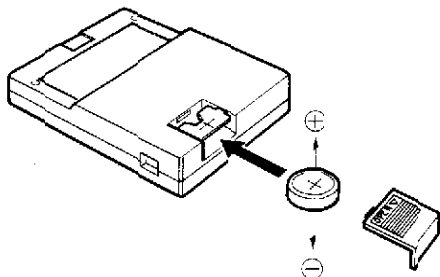

Close the battery access cover, unplug the AC Adapter and insert the RAM Cartridge back into the PC-8300.



Don't plug the AC Adapter PC-8271A-01 into a RAM Cartridge while the RAM Cartridge is still inserted into the PC-8300.



The date the insulating plate between the battery and the contact was removed is the first date for the battery life record. See Chapter 6.4.1 for instructions on removing the insulating plate.

### Battery Precautions

- If the battery catches on the battery contact during insertion, press it in with the tip of a ball-point pen
- Make sure your fingers are clean before you touch the battery.
- Store the battery away from direct sunlight and at low temperature and low humidity.
- When the RAM Cartridge is not used for an extended period of time, remove the battery and store it in a safe place. Remember that removing the battery will cause all data stored on the RAM Cartridge to be lost.
- The battery cannot be recharged.

## 6.4.6 Troubleshooting

1. Incorrect data appears in the MENU screen when you are using bank #3.
  - Did you do a cold start on bank #3?
  - Has the battery been used for more than six months?
  - Is the insulating plate removed?
  - Did you insert or remove the RAM Cartridge when the PC-8300 power was on?
2. Contents of a file are destroyed.
  - Has the battery been used for more than six months?
  - Is the insulating plate removed?
  - Did you insert or remove the RAM Cartridge when the PC-8300 power was on?
3. When you try to access the RAM Cartridge, you cannot select bank #3.
  - Is the RAM Cartridge securely connected to the PC-8300 system slot?
  - Is the PROTECT switch of the PC-8206A turned off?

If you have checked all the above items and the RAM Cartridge still is not working properly, contact your NEC Dealer, or contact your nearby NEC services offices, listed in Appendix I.

## 6.5 DISK DRIVE

A disk drive is a device that reads and writes computer programs and data on magnetic media. The magnetic media in this case is a micro floppy (flexible) disk enclosed in a protective cover.

A disk drive stores data externally which the computer cannot store internally because of internal memory size. In addition, a disk drive provides more permanent non-volatile file storage to maintain data safety and integrity.

A disk drive has many advantages over other external storage devices. These advantages include high storage capacity, high speed data reading and writing, and dependability.

External data storage is almost unlimited when using a library of disks with several data files on each disk. In addition, each disk has its own record of files called the directory. Reading the directory gives you the convenience of knowing what files are on the disk without having to read the entire disk.

### 6.5.1 Introducing the PC-8231A Micro Disk Unit and the Micro Floppy Disk

The PC-8231A Micro Disk Unit is an external storage device developed especially to work with the PC-8300 portable computer.

The PC-8231A is an intelligent drive consisting of one 3 1/2 inch floppy disk drive, a drive controller, and a power unit. The PC-8231A Disk Drive Unit operates on 120V AC power.

The PC-8231A diskettes provides 327.68K bytes of formatted storage area per disk. You can store a maximum of 128 files per disk.

The features of the PC-8231A are shown in the illustrations below.

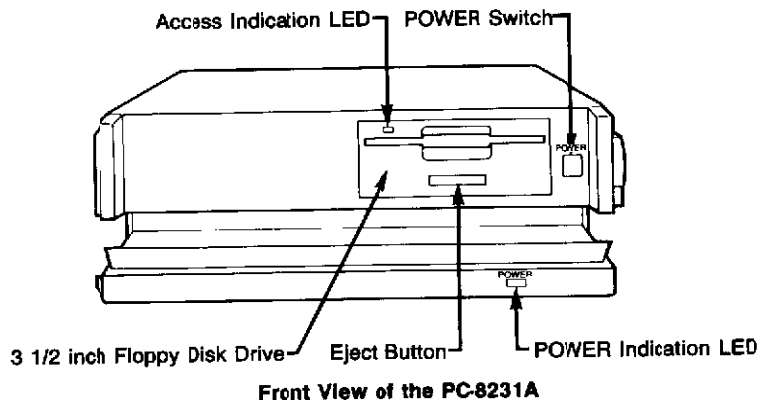

#### Power Switch

This turns the power to the PC-8231A off and on.

#### Power Indication LED

This green LED is lit when the power is on.

### Access Indication LED

This red LED is lit when the disk drive is reading data from the disk or writing data to the disk. When the disk drive is not reading or writing data, the access indication LED will be off or will be lit at about 20% of its normal brightness.

### 3 1/2 Inch Floppy Disk Drive

This is the single sided, 80 track 3 1/2 inch floppy disk drive.

### Eject Button

Pressing this button ejects the micro floppy disk out from the drive. You can then gently pull the disk out of the drive. When the disk is inserted in the drive, the eject button is popped out.

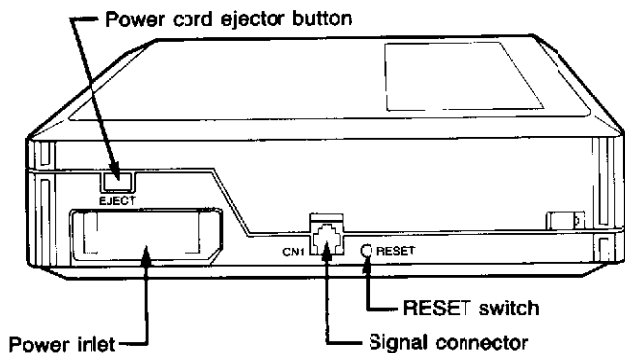

**Side View of the PC-8231A**

### Signal Connector CN1

This connector is used to transmit signals which the PC-8300 uses to control the operations of the PC-8231A. It uses an 8 pin modular cable as standard equipment, and connects directly to the Floppy Disk Drive (FDD) port of the PC-8300.



## RESET switch

Pushing this switch executes bootstrap 1 (please refer to the PC-8231A User's Guide), regardless of what operations the unit is performing. This switch can be operated by pushing it all the way in and releasing it by using a slender object such as the point of a ballpoint pen.

## Power cord ejector button

This button is used to remove the AC pack or battery pack from the Micro Disk Unit. Be careful, as the AC pack or battery pack will shoot out quickly.

## 6.5.2 The Micro Floppy Disk

The PC-8231A Micro Floppy Disk Unit stores data on 3 1/2 inch disks. Please contact your NEC Dealer for disks.

The illustration below shows the top and bottom of a micro floppy disk.

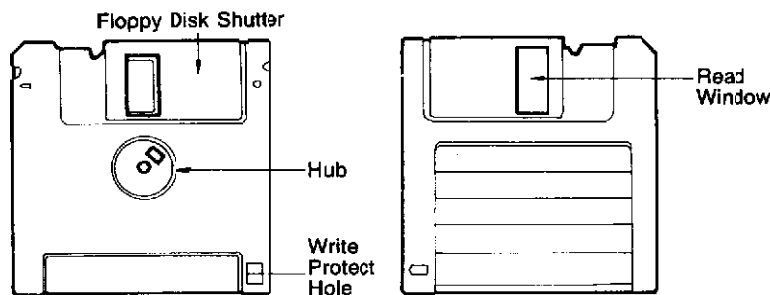

**Bottom of Micro Floppy Disk**

**Top of Micro Floppy Disk**

The shutter opens when the disk is inserted into the disk drive, but it closes when the disk is removed from the drive. This provides very effective protection for the disk.

Insert the disk correctly into the drive. Insert the disk straightly with the hub side down. Push the disk into the drive gently until it locks in place.

When the write protect hole is open, you cannot save files to the disk. When the write protect hole is closed, you can save files to the disk. Open the write protect hole on the disk if important data and files which should not be altered are stored on the disk. Close the write protect hole to update programs and data. The write protect hole is opened or closed by sliding the small knob.



Don't touch the head window with your finger. Any dust on your fingers can damage the disk and cause data errors.

### 6.5.3 Connecting the Disk Unit



Make sure that the power supplies of both units are off when connecting the units together.

#### Connection of the PC-8231A's Signal Connector

The standard 8 pin signal connector is on the left side of the PC-8231A unit. Connect the end with the ferrite toroid to the Micro Disk Unit.

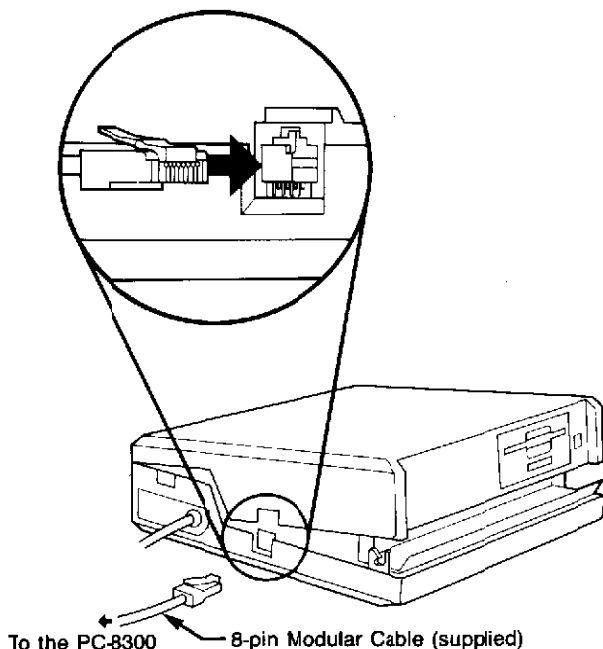

## Connection to the PC-8300

After connecting one end of the 8 pin modular cable to the PC-8231A unit, connect the other end to the connection which has no ferrite toroid, marked FDD, on the back panel of the PC-8300.

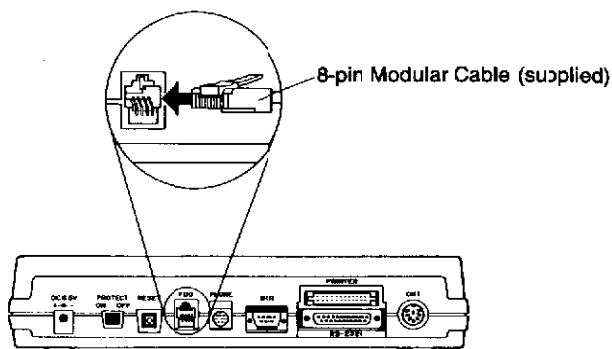

## Inserting the AC Power Pack

Power to the Micro Disk Unit can be supplied from the AC pack (included). The AC power can be obtained by inserting the AC pack as shown. Be sure to insert the AC pack into the device until it clicks in place, thus making sure that it will not pop out during use. The inlet is usually covered by a sliding cover.

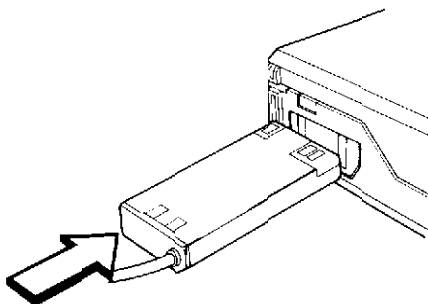

## 6.5.4 Operating the PC-8231A Micro Disk Unit

### Opening the PC-8231A

The lid of the PC-8231A is opened by the slide-lock buttons on the left and right side of the unit. Place your hands on both of these buttons and lift the top half of the unit up while pulling these slide-lock buttons. Raise the front side of the unit approximately 2 inches (5cm) and the lid will automatically open and the front side of the unit will slowly come down. The lid will support itself in the open position.

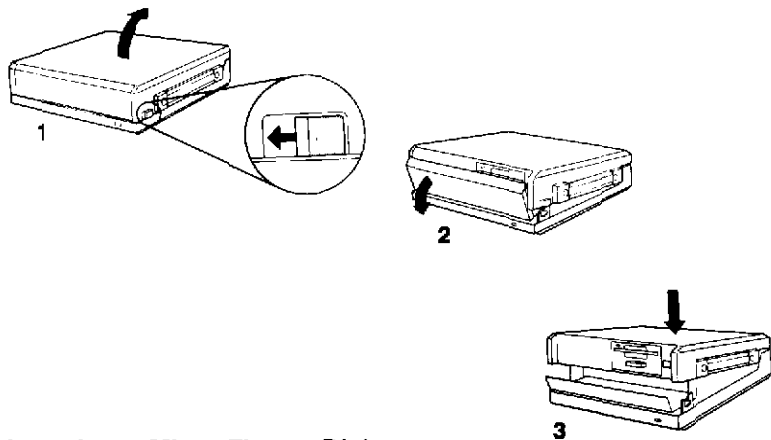

### Inserting a Micro Floppy Disk

To insert a micro floppy disk into the PC-8231A, first make sure the power to the PC-8231A is turned on.

Position the micro floppy disk with the top side up into the drive until about 1/2 inch of it can be seen.

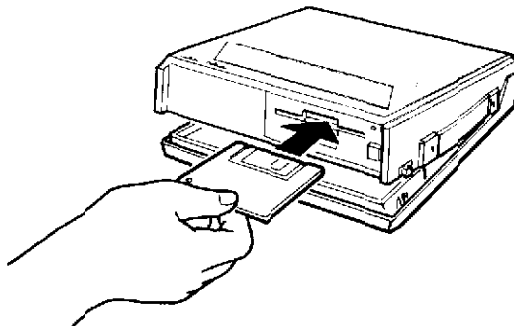

Then, gently push the micro floppy disk into the drive until it clicks into place, the eject button is popped out, and the drive is closed.

The figure below left shows the micro floppy disk **properly** inserted.

The figure below right shows the micro floppy disk **improperly** inserted.

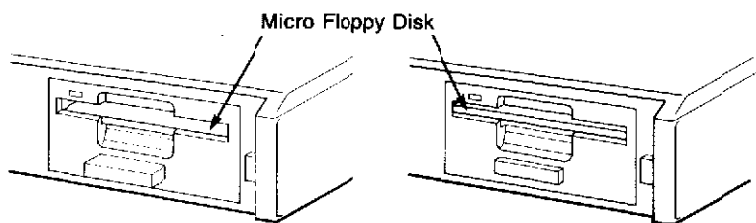

**Correctly inserted position**

**Incorrectly inserted position**



Bending or forcing the micro floppy disk into the drive may damage it.

## Removing a Micro Floppy Disk

To remove a micro floppy disk from the drive, first push the eject button on the PC-8231A in until the micro floppy disk pops out of the drive. Then simply remove the disk.

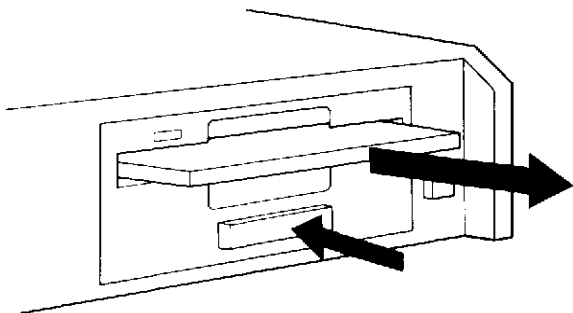

Never remove the micro floppy disk from the drive when the access indicator LED is on or before an open file is closed. You may cause a read error and the data may be permanently damaged.

## Closing the PC-8231A

To close the PC-8231A, first remove the micro floppy disk from the drive. Turn the power to the PC-8231A off.

Using both hands, raise the upper half of the unit about 2 inches (5 cm) and use one hand to support the unit while closing the lid with the other hand. Then lower the upper half of the unit down gently and close the lid by pulling with both hands on the left and right slide-locks. Be sure that the upper and lower body halves are correctly locked together by pushing the slide-locks in.

Lift the unit

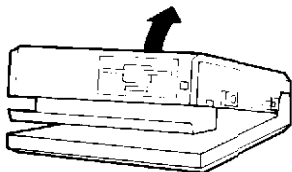

Close the lid with one hand

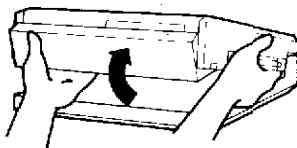

Lower the lid while gently pushing on it

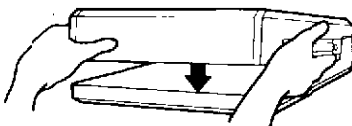

Lock the two halves together and push in the slide-locks

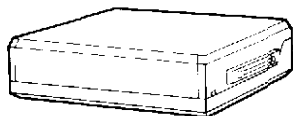

Never move or carry the PC-8231A without closing it tightly and locking it down securely.

### 6.5.5 Booting the Disk Code

Since the stand-alone PC-8300 has no disk operation system it is necessary to load the disk operating system into the PC-8300 RAM and the RAM in the Disk Unit from the system disk. This is called bootstrap sequences.

After connecting the units, insert the system disk PC-8234A, and when you turn on the Disk Unit, a part of the DISK CODE operating system is loaded into the RAM in the Disk Unit from the system disk (bootstrap 1).

Then when you turn the PC-8300 on, the DISK CODE operating system which is meant to reside in the PC-8300 RAM is read (bootstrap 2).

You can see the message "Disk version" on the beginning screen of BASIC.

```
NEC PC-8201 BASIC Ver 1.1 (C) Microsoft
Disk BASIC Ver 2.0
25717 Bytes free
Ok
■
Load " Save " Files List Run
```

Please refer to the PC-8231A User's Guide for more detailed information.

## 6.5.6 Operating the PC-8300 MENU with the Disk Unit

With the DISK CODE operating system loaded into the PC-8300 RAM, the functions of MENU and BASIC are enhanced to enable them to be used with the Disk Unit.

You can use MENU's LOAD and SAVE commands on the disk files.

### To LOAD a File from the Disk:

1. Type  (LOAD) in the MENU mode.

The last line will be:

```
Load from _
```

2. For example, to load a file called "TANK" from the disk, type:

**1:TANK**

and press . "1:" is the device name of the disk drive. You will see the next prompt:

```
Save as _
```

3. Specify the file name you want to name the file that will copied in the PC-8300 RAM. For example type:

**TANK.BA**

and press .

4. Type **Y** (for Yes) to the next prompt.

```
Save as TANK.BA Ready? _
```

5. The PC-8300 will read the file on the disk and copy it to RAM. After loading the file you can see the file name "TANK.BA" in your MENU screen.



**To SAVE a File to a Micro Floppy Disk:**

1. Select a file name you want to copy onto your floppy disk by putting the directory cursor over it.

For example you select "PHONE.DO" like this:

1986/12/01	14:18:25	(C) Microsoft #1	
EASIC	TEXT	TELCOM	IETTER.DO
SAMPLE.DO	ADIR.DO	COSTS.DO	<b>PHONE.DO</b>
..-	..-	..-	..-
..-	..-	..-	..-
..-	..-	..-	..-
..-	..-	..-	..-
Load	Save	Name	List
			25496

2. Press **F2** (SAVE). You will see the prompt:

Save PHON.DO as \_

3. Specify the file name with the device name '1:'. for example type:

**1:PHONE.n82**

and press **↵**.

4. If the file on the RAM has the ".BA" extension, select B or A for the next prompt:

B(inary) or A(sci)? \_

5. Type Y (for Yes) to the "Ready?" prompt if your equipment is ready:

B(inary) or A(sci)? B. Ready? \_

6. The file is saved to the disk. You can see the filename "PHONE.n82" by using the BASIC FILES Command. Refer to the FC-8231A User's Guide for detailed information.

```
NEC PC-8201 BAIC Ver 1.1 (C) Microsoft
Disk BASIC Ver 2.0
xxxxx Bytes free
Ok
files 1
PHONE.n82      1
Ok
Load " Save " Files List Run
```

### 6.5.7 Operating N82-BASIC with the Disk Unit

With the DISK CODE operating system loaded into the PC-8300 RAM, the functions of MENU and EASIC are enhanced to enable them to be used with the Disk Unit.

Most of the enhanced functions are supported in the BASIC mode.

#### Utility Programs

Three convenient utility programs are in the system disk included in the PC-8231A box.

##### **format.n82**

This utility formats micro floppy disks. It is necessary to format any new disks, or those formatted by machines with different formats.

##### **backup.n82**

This utility copies the contents of an entire disk to another disk. It is recommended to make backup copies of your important files.

##### **xfiles.n82**

This utility transfers specified file(s) to another disk.

## Enhanced BASIC

Some instructions are enhanced for disk handling.

Example: LOAD, SAVE, NAME, OPEN, RUN, KILL, etc.

Some functions are newly added to enable the use random files on disks.

Example: STATUS CVI, STATUS MKI\$, etc.

Please refer to the N82 DISK-BASIC Chapter of the PC-8231A User's Guide when you write BASIC programs for use on disks.

## 6.5.8 Care and Handling of Micro Floppy Disks

### Before Using a Micro Floppy Disk



- Don't use a disk if it's damaged, bent, warped or if its shutter does not move in and out of place easily.



- If the micro floppy disk has been stored under different temperature and humidity than the micro floppy disk unit, let the disk stand at least five minutes before using it to equalize the temperature and humidity. The temperature gradient should be 68°F/hour (20°C/hour) with no condensation.

### Inserting the Micro Floppy Disk

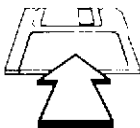

- Insert the disk gently and straight into the drive. Otherwise, you may bend the floppy disk shutter or damage the inside of the drive.
- For best results, store your micro floppy disks in a dust-free environment. Store the micro floppy disk with the shutter closed.

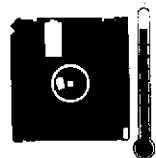

- Don't place things on the micro floppy disk or the disk may be damaged.
- Don't expose the micro floppy disk to direct sunlight or high temperatures {maintain temperature between 50°F (10°C) and 125°F (51°C)}.



- Keep the disk away from magnets and magnetic fields.  
If the disk is exposed to a magnetic field stronger than 50 Oe, errors in data may result.
- Don't try to clean the micro floppy disk.
- Don't bend the micro floppy disk.

### Labelling a Micro Floppy Disk

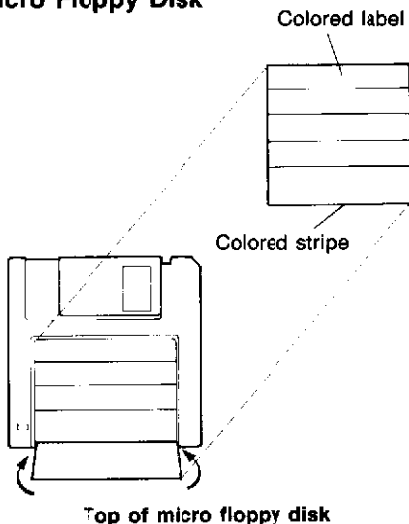

You can easily label the micro floppy disk with colored adhesive labels which come in the package when you buy micro floppy disks. The labels stick to the micro floppy disks. List information about the files stored on the disk on the label.

### Hints for Writing on the Labels

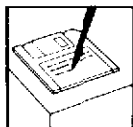

- Don't write directly on the micro floppy disk.  
Always write on the label and then later stick the label to the micro floppy disk.
- Write on the label with a felt-tip pen before sticking it to the micro floppy disk. Cross out old information but never use an eraser.



- Never use a ball-point pen, pencil or eraser. Dust and other dirt from the pencil or eraser can damage the disk surface and cause data errors.



- Close the disk shutter before writing on the label attached to the disk. If the head window is open, you may touch the recording surface and cause a data error. Place the micro floppy disk on a level surface when writing. Otherwise, the micro floppy disk may be damaged.



- To change a label, first remove the old label and pull the remains of the adhesive from the disk. Attach a new label. Don't stick a new label over the old one.

## 6.5.9 Maintaining the Micro Disk Unit



- Don't store or use the Micro Disk Unit in direct sunlight or near a radiant heat source.
- Don't store or use the Micro Disk Unit where it's humid or dusty.



- A vent on the top of the Micro Disk Unit prevents over-heating. Elevate the upper half when using the unit.
- Don't block the vent. Use the Micro Disk Unit in a properly ventilated area.
- Don't place objects (manuals, papers, etc.) on top of the unit. This can cause overheating.



- The Micro Disk Unit is made up of delicate electronic parts, so don't drop it.
- Don't store or use the unit under extremely high or low temperatures or where the temperature varies rapidly.



- Don't spill anything on the Micro Disk Unit.
- Make sure that metals and other foreign materials do not enter the disk drive.



- Operating the Micro Disk Unit near a radio or TV may cause interference with the TV or radio reception.
- Don't store or use the unit near an electrical or magnetic field.



- Wait at least five seconds after turning the disk unit off before turning it back on.



- To clean the Micro Disk Unit, wipe it lightly with a soft cloth slightly moistened with water or a neutral detergent.
- Don't use volatile chemicals like benzene or paint thinner to clean the unit. This may deform or discolor the Micro Disk Unit.

### 6.5.10 Troubleshooting

If you experience any of these problems, try the solutions listed below. If, after trying these solutions, the Micro Disk Unit still does not work properly, contact any NEC Dealer or contact your nearby NEC agent listed in Appendix I.

#### 1. The disk drive does not operate.

- Is the power switch pushed in?
- Is the power supply LED illuminated?
- Is the connection between the PC-8300 and the PC-8231A secure?
- Are the cables connected correctly?
- Did you perform a boot sequence correctly?

2. You can't read data from, write data to or transfer files to the micro floppy disk. "?IO Error" keeps coming up on the screen.
  - Is the micro disk positioned correctly within the drive?
  - Is the micro floppy disk damaged physically or electronically?
  - Is the micro floppy disk formatted properly?
  - If you're trying to save files to the micro floppy disk or transfer files to the micro floppy disk, is the disk write-protected?
3. You're trying to save files or transfer files to the micro floppy disk and you get "?DF Error" (Disk Full message).
  - Use the DSKF function of BASIC to find out how much storage space is available on the disk. If there's not enough to save the files, remove the micro floppy disk and insert a new, formatted one into the drive to save the files.

## 6.6 OTHER PERIPHERAL DEVICES

### Using CRT Monitor

With the CRT Adapter PC-8241A-K connected to the system slot of the PC-8300 you can switch the screen from the LCD to a CRT monitor.

Please refer to the PC-8241A User's Guide for detailed information.



When you use the CRT as a screen, the symbols of the TEXT editing commands (P) are displayed as a caret (^).



To connect a CRT monitor to the CRT Adapter, use the CRT Cable PC-8292A included in the PC-8241A-K box.

## **Bar Code Reader**

The PC-8300 has a BCF port on its rear side. You have barcode reading utilities in the Application tape included in the PC-8300 box. A bar code wand is not provided by NEC but the following wands are recommended for use with the PC-8300:

HEWLETT PACKARD HEDN-3000/3050

BarComp BL-25-2

We recommend you to contact the store where you purchased your PC-8300 about the latest models of bar code wands.



# APPENDICES

---

A. HARDWARE SPECIFICATIONS .....	130
B. I/O INTERFACE .....	135
C. MEMORY MAP .....	141
D. CHARACTER CODES .....	143
E. OPTIONAL ACCESSORIES .....	144
F. SWITCHING THE CHARACTER SET .....	147
G. SWITCHING TO THE PC-8201A MODE .....	151
H. GLOSSARY .....	153
I. LIST OF NEC SERVICE OFFICES .....	155

# APPENDIX A

## HARDWARE SPECIFICATIONS

---

### PC-8300 Portable Computer

Principal dimensions:	11 7/16" approx. (300mm) length 8 7/16" approx. (215mm) width 1 3/8" approx. (35mm) front height 2 1/2" approx. (61mm) rear height
Weight:	3.43 lbs. (1.56 kg.)
CPU:	80C85
Clock:	2.4 MHz
ROM:	32K × 4 (standard 32K × 2 used by built-in software, 32K × 2 system reserve) 32K (optional, connects into the IC socket)
RAM:	64K (standard) 32K (optional, with the RAM Cartridge PC-8206A) 32K × 4 (optional, with the RAM Cartridge PC-8207A)
Keyboard:	67 keys in total: 5 function keys, and 5 more functions using <b>SHIFT</b> 4 cursor keys 58 additional keys
LCD:	Effective display area 7 1/2" approx. (191.2mm) length 2" approx. (50.4mm) width Resolution 240 × 64 dots Dot size 0.73 × 0.73mm Dot pitch 0.8mm Display characters 40 characters per line × 8 lines Inverse display possible by means of escape sequences

### Electrical Power Section of the PC-8300

Battery case:	4 standard or alkaline AA batteries Non-rechargeable Batteries can be replaced External dimensions: 2 3/4" approx. (70mm) width 3 1/6" approx. (80.5mm) depth 3/4" approx. (19mm) thickness
---------------	---------------------------------------------------------------------------------------------------------------------------------------------------------------------------------------------------------------

## Length of operation:

- 4 alkaline batteries - Up to 18 hours  
(constant use at normal temperatures)
- 4 standard batteries - Up to 6 hours  
(constant use at normal temperatures)

## Output:

DC 6 V 600 mA

## Batteries for

emergency operation: 50 mA/h 3.6 V NiCd batteries installed inside the PC-8300

Trickle-chargeable from whatever batteries operation are used as the electrical power source for the basic unit

A battery-discharge-prevention switch is included

Emergency operation battery back-up time limit:

Up to 7 days

## Power of:

Power manually turned off by means of the POWER switch

Controllable by means of the POWER command in BASIC

Automatic power shut-off when no key has been input after 10 minutes (this interval can be varied from 1 minute to 25 minutes)

## Low Battery LED:

The LED will light up when the electrical power decreases below a certain level.

## Changing batteries:

After the PC-8300 has become battery inoperable due to power shortage.  
After 7 days

## Operating Conditions:

	Ambient temperature (°F)                      (°C)		Relative Humidity (%)	Maximum wet-bulb temperature
Operation	41 — 95	5 — 35	20 — 80	No condensation AT 77°F (25°C)
Transport	14 — 122	-10 — 50	20 — 80	
Storage	14 — 122	-10 — 50	20 — 80	

Leaving this machine in a hot environment such as a car or a trunk may permanently damage it.

**OPTIONAL ACCESSORIES****AC Adapter PC-8271A-01**

Standard output: 8.5V 100 mA

No-load output: 11V

Input voltage: 120V ± 10%

Frequency: 50/60 Hz

## **NICD Battery Cartridge PC-8201A-90/PC-8301A-90**

500 mA/h

Rechargeable by AC Adapter

A charging circuit from the PC-8300 to the unit's electrical power supply.

Retention of charge: up to 48 hours

Batteries not replaceable

Dimensions:

2 3/4" approx. (70 mm) length

3 1/6" approx. (80.5 mm) width

3/4" approx. (19 mm) thickness

## **128K byte (32K bytes x 4) RAM Cartridge PC-8207A**

Capacity: 32K bytes x 4 = 128K bytes total  
(One of the four blocks can be selected by the BLOCK switch.)

Lithium battery included as back-up power source

Duration of back-up power: up to 6 months (at temperatures lower than 104°F  
(40°C))

The batteries can be changed without erasing the RAM contents by plugging the AC Adapter for the PC-8300 into the power inlet of the PC-8207A RAM Cartridge, and then charging its batteries.

Dimensions: 3 7/8 inches (99 mm) long  
(not inserted into PC-8300 system slot)  
3 7/8 inches (99 mm) wide  
1 1/16 inches (27 mm) high

Weight: 0.29 lbs (130 g)

## **32K byte RAM Cartridge PC-8206A**

Capacity: 32K bytes  
8K byte RAM chips (4 separate chips per pack)

Lithium battery included as backup power source

Duration of backup power: Up to 6 months  
(at normal temperature)

Write protect switch included

Battery can be replaced (so that the contents on the RAM Cartridge will not be erased) by connecting the AC Adapter designed for the PC-8300 unit into the jack on the side of the PC-8206 RAM Cartridge.

Use only the AC Adapter specified above, as an AC Adapter with the wrong electrical specifications may damage the RAM cartridges.

Dimensions: 3 18/16" approx. (100.5 mm) length  
3 1/3" approx. (85 mm) width  
2/3" approx. (16 mm) height

Weight: 0.24 lbs (110 g)

**300 baud Modem Card PC-8361A**

Data transfer system: synchronous binary serial signal

Transfer speed: 300 BPS

Modulation system: Frequency Shift Keying (FSK)

Modem Mode: Full duplex

Transmit level: -10 dBm (typical)

Receive level: -6 to -40 dBm



The condition of the line influences the actual receive level.

Carrier detect trip point: CD ON -44 dBm (typical)  
CD OFF -47 dBm (typical)

Auto dial system: DP, PB

Dial pulse speed: 10 PFS, 20 PPS

	10 PPS	20 PPS
Pulse make	= 39 ms	= 20 ms
Pulse break	= 61 ms	= 30 ms
Minimum	> 600 ms	> 450 ms

DTMF output:

	f (Hz) L	f (Hz) L
1	697	1209
2	697	1336
3	697	1477
4	770	1209
5	770	1336
6	770	1477
7	852	1209
8	852	1336
9	852	1477
0	941	3336
*	941	1209
#	941	1477
A	697	1633
B	770	1633
C	852	1633
D	941	1633

Power supply: Supplied from the PC-8300  
Dimensions: 1 13/16 inches (48 mm) long  
3 9/16 inches (92 mm) wide  
Weight: 0.15 lbs (70 g)

**Operating Conditions:**

	Ambient temperature (°F)	(°C)	Relative Humidity (%)	Maximum wet-bulb temperature
Operation	4 — 95	5 — 35	20 — 80	No condensation AT 77°F (25°C)
Transport	14 — 122	-10 — 50	20 — 80	
Storage	14 — 122	-10 — 50	20 — 80	

Leaving this card in a hot environment such as a car or a trunk may permanently damage it.

# APPENDIX B

## I/O INTERFACE

### RS-232C D SUB 25 Pin

Connectbr: 25pin D SUB

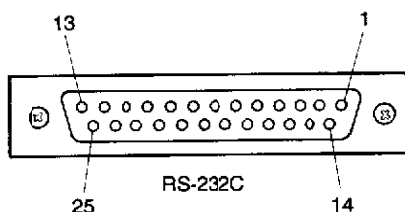

Pin Number	Signal Name	Remarks
1	GND	Protective ground
2	TxD	Transmit Data
3	RxD	Receive Data
4	RTS	Request To Send
5	CTS	Transmission authorized
6	DSR	Data Set Ready
7	GND	Signal Ground
8	DCD	Data carrier detect
9—19	NC	Not Connected
20	CDR	Data carrier ready
21	NC	Not Connected
22	RD	Bell detect
23—25	NC	Not Connected

Data Length: 6, 7, 8 bits  
 Parity: None, Odd, Even  
 Stop bits: 1, 2 bits  
 Baud rates: 75  
 110  
 300  
 600  
 1200  
 2400  
 4800  
 9600  
 19200

## FDD (Floppy Disk Drive)

Connector: 8 pin DuPont BERG modular jack

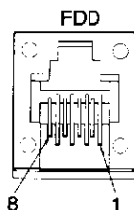

Pin Number	Signal Name	Remarks
1	GND	Signal Ground
2	TxD	Transmit Data
3	RxD	Receive Data
4	RTS	Request To Receive
5	CTS	Transmission authorized
6	Vcc	+5 V
7	NC	Not Connected
8	NC	Not Connected

Transmission distance: 3 m minimum

Data length: 8 bits

Baud rate: 19200

Parity: None

Stop bits: 1, 2 bits

## CMT (Cassette Magnetic Tape)

Connector: 8 pin DIN plug

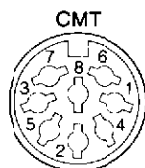

Pin number	Signal name	Remarks
1	$\bar{x}C$	TTL level output
2	GND	Signal Ground
3	GND	Electrical power Ground
4	MIC	Output to a MIC
5	EAR	Input from EAR
6	REM1	REMOte terminal
7	REM2	REMOte terminal
8	Vcc	+5 V



Transmission distance: 1.5 m minimum  
 Baud rate: 600  
 File format: N-BASIC compatible  
 Output level: MIC level

### BCR (Bar Code Reader)

Connector: 9 pin D SUB

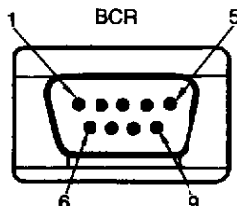

Pin number	Signal name	Remarks
1	NC	Not Connected
2	RxDB	Receive Data
3	NC	Not Connected
4	NC	Not Connected
5	GND	Signal Ground
6	NC	Not Connected
7	GND	Signal Ground
8	NC	Not Connected
9	Vcc	-5 V

Recommended Model: HEDN-3000/3050  
 BL-25-2

Hewlett Packard  
 BarComP

### PHONE Port

Connector: 8 pin mini DIN plug

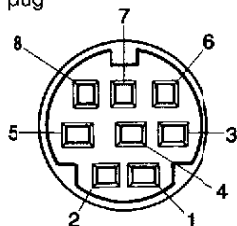

Pin Number	Signal Name	Remarks
1	TL	Tel Line
2	AGND	Analog Ground
3	RXMD	Ring
4	RXMAC	System Reserved
5	TXMAC	System Reserved
6	VDD	-5 V
7	TXMD	Tip
8	NC	Not Connected

8 1/2  
11 1/2

## PRINTER

Connector: 26 pin connector using a fat cable

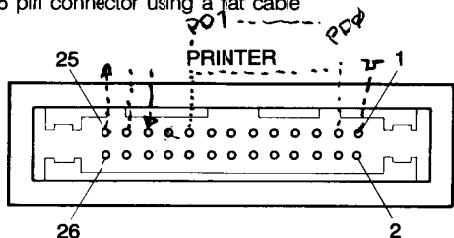

Pin number	Signal name	Remarks
1	STROBE	WRITE STROBE
2	GND	Signal Ground
3	PD0	Parallel Data 0
4	GND	Signal Ground
5	PD1	Parallel Data 1
6	GND	Signal Ground
7	PD2	Parallel Data 2
8	GND	Signal Ground
9	PD3	Parallel Data 3
10	GND	Signal Ground
11	PD4	Parallel Data 4
12	GND	Signal Ground
13	PD5	Parallel Data 5
14	GND	Signal Ground
15	PD6	Parallel Data 6
16	GND	Signal Ground
17	PD7	Parallel Data 7
18	GND	Signal Ground
19	NC	Not Connected
20	GND	Signal Ground
21	BUSY	Printer BUSY
22	GND	Signal Ground
23	SYSTEM	SYSTEM Received
24	GND	Signal Ground
25	SLCT	Printer Select
26	NC	Not Connected

## SYSTEM SLOT

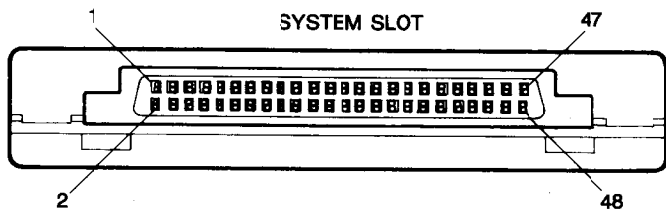

Pin number	Signal name	Remarks
1	VDC	+5 V
2	VDC	+5 V
3	AD0	Address/Data 0
4	AD4	Address/Data 4
5	AD1	Address/Data 1
6	AD5	Address/Data 5
7	AD2	Address/Data 2
8	AD6	Address/Data 6
9	AD3	Address/Data 3
10	AD7	Address/Data 7
11	NC	Not Connected
12	NC	Not Connected
13	A8	Address 8
14	A12	Address 12
15	A9	Address 9
16	A13	Address 13
17	A10	Address 10
18	A14	Address 14
19	A11	Address 11
20	A15	Address 15
21	A16	Not Connected
22	A18	Not Connected
23	A17	Not Connected
24	A19	Not Connected
25	NC	Not Connected
26	NC	Not Connected
27	RD	Read
28	WR	Write
29	IO/M	IO or Memory
30	ALE	Address Latch Enable
31	HOLD	HOLD
32	HO_DA	HOLD Acknowledge
33	INTR	INTERRUPT
34	INTA	INTER Acknowledge
35	RESET	RESET
36	READY	READY
37	ROME	ROM Enable
38	E	Enable
39	BANK #3	RAM Cassette Select signal
40	NC	Not Connected
41	HARD	High Address Disable
42	LARD	Low Address Disable
43	CLK	CLOCK
44	POWER	RAM Protect signal
45	GND	Ground
46	GND	Ground
47	NC	Not Connected
48	NC	Not Connected

## Function Block Diagram

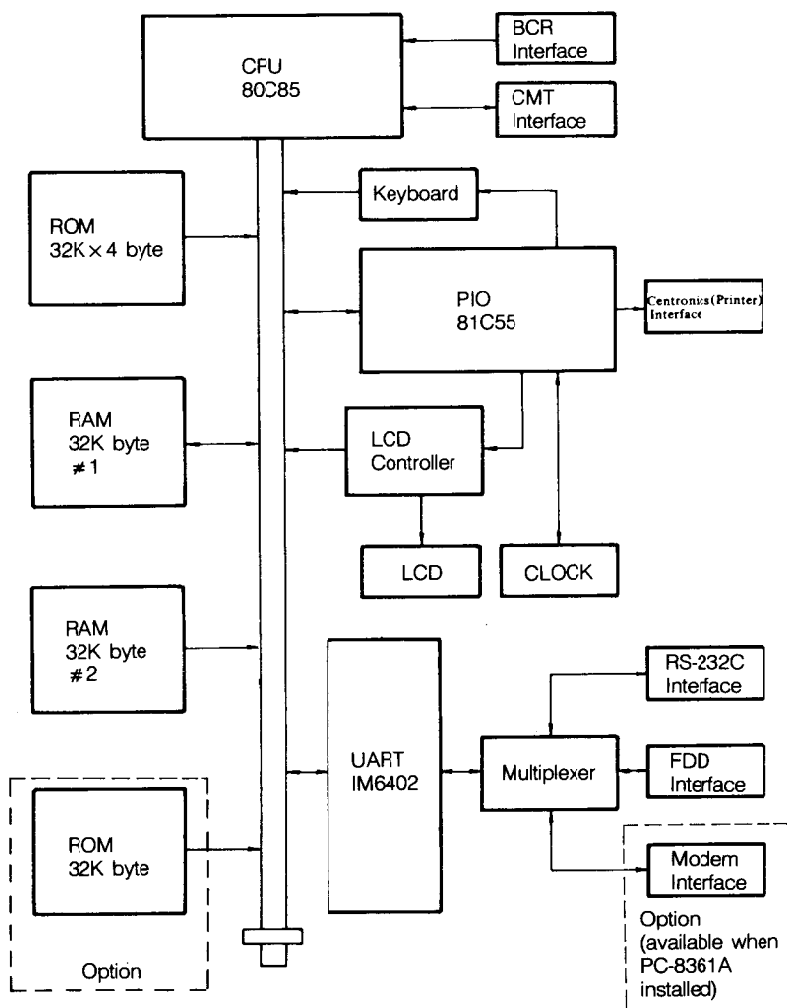

# APPENDIX C

## MEMORY MAP

The PC-8300's 8-bit CPU (80C85) can access 64K bytes of memory at a time. The address is allocated from address 0 to address 65535 (FFFF hexadecimal).

The lower half 32K bytes (address 0 to 32767) are assigned to the ROM area, and the higher half 32K bytes (address 32768 to 65535) are for RAM.

You have 32K x 4 byte ROM in the standard PC-8300. The PC-8300's software (MENU, BASIC, TEXT, and TELCOM) is in two of these 32K byte ROM areas, and remainder is reserved for the PC-8300 system. The software automatically switches between these two banks of ROM.

You can also install optional user ROM into the PC-8300.

The standard PC-8300 has two banks of RAM, selectable by the MENU's BANK command. By using optional RAM Cartridge, a third RAM bank is available.

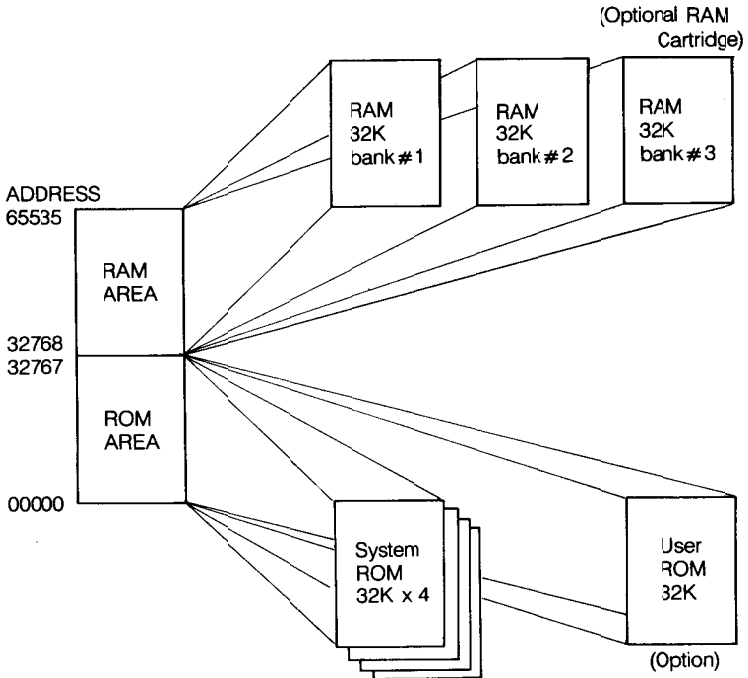

Each RAM bank is as explained in the figure below:

65535

62336

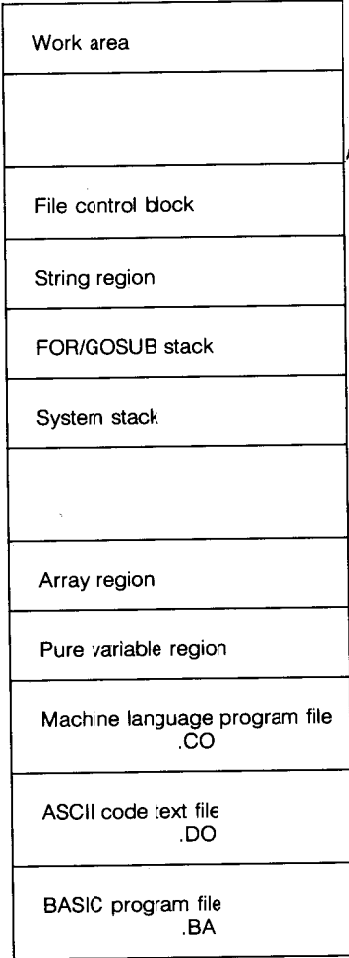

Changes according to BASIC's CLEAR statement's second parameter

Changes according to MAXFILES command of BASIC

Changes according to BASIC's CLEAR statement's first parameter

32768

# APPENDIX D

## CHARACTER CODES

DECIMAL		Lower 4 bits															
		0	16	32	48	64	80	96	112	128	144	160	176	192	208	224	240
		HEX BINARY	0 0000	1 0001	2 0010	3 0011	4 0100	5 0101	6 0110	7 0111	8 1000	9 1001	A 1010	B 1011	C 1100	D 1101	E 1110
Higher 4 bits	0	0 0000	C/R C/P	(SPACE)	0	@	P	r	p	C/Z ◀	G/Q	GS/Z	GS/Q				
	1	1 0001	C/A S/r	C/Q C/r			A	Q	a	q	C/X J	G/W	GS/X	GS/W			
	2	2 0010	C/B S/r	C/R INS C/r	"	2	B	R	b	r	C/C █	G/E	GS/C	GS/E			
	3	3 0011	C/C STOP	C/S	≠	3	C	S	c	s	G/V	G/R	GS/V	GS/R			
	4	4 0100	C/D S/r	C/T S/r	\$	4	D	T	d	t	G/B	G/T	GS/B	GS/T			
	5	5 0101	C/E S/r	C/U	%	5	E	U	e	u	G/N	G/Y	GS/N	GS/Y			
	6	6 0110	C/F S/r	C/V	&	6	F	V	f	v	G/M	G/U	GS/M	GS/U			
	7	7 0111	C/G BS	C/W C/r	'	7	G	W	g	w	G/L	G/I	GS/L	GS/I			
	8	8 1000	C/H C/r	C/X		8	H	X	h	x	G/A	G/O	GS/A	GS/O			
	9	9 1001	C/I C/r	C/Y	)	9	I	Y	i	y	G/S	G/P	GS/S	GS/P			
	10	A 1010	C/J C/r	C/Z C/r	*	:	J	Z	j	z	G/D	G/B	GS/D	GS/B			
	11	B 1011	C/K C/r	ESC	†	;	K	[	k	{	G/F	G/A	GS/F	GS/A			
	12	C 1100	C/L C/r	→	,	<	L	\	l	!	G/G	G/	GS/G	GS/			
	13	D 1101	C/M C/r	←	=	M	]	m	}		G/H	G/	GS/H	GS/			
	14	E 1110	C/N C/r	↑	.	>	N	^	n	~	G/J	G/	GS/J	GS/			
	15	F 1111	C/O C/r	↓	/	?	O	_	o	{DEL}	G/K	G/	GS/K	GS/			

- Notes:**
1. C/r means hold **CTRL** while pressing "r".
  2. S/r means hold **SHIF** while pressing "r".
  3. G/r means hold **GRPH** while pressing "r".
  4. GS/r means hold **SHFT** and **GRPH** while pressing "r".

**Example:** To find the character code of "A", add 1 to DECimal 64, or to HEX 40.  
Thus the character code of "A" is 65 DEC or 41 HEX (0100C001 BINARY).

### Code:

- 00H — 1FH: Unique code that cannot be output as characters (See N82-BASIC Reference Manual Appendix A.3 Control Codes)
- 83H — DFH: User-defined characters (Can be input from the keyboard)
- E0H — FFH: User-defined characters (Can be output by using the CHR\$ function)

# APPENDIX E

## OPTIONAL ACCESSORIES

### E.1 Optional accessories compatible with the PC-8300

The following table lists the optional accessories compatible with the PC-8300, as well as special cables for hardware or software requirements.

Accessories	Special Requirements
<b>Disk Unit</b> PC-8231A-K Micro Floppy Disk Unit	System disk (PC-8234A) and cable (PC-8294A) are included with the PC-8231A-K man unit.
<b>RAM Cartridge</b> PC-8207A 32 x 4 byte RAM Cartridge PC-8206A 32K byte RAM cartridge	No special requirements No special requirements
<b>Data Recorder</b> PC-8281A Battery Operated Portable Data Recorder  It is possible to use any commercially available audio cassette recorder.	Cable PC-8493A is included with the PC-8300.
<b>Printers</b> PC-PR105A Dot Matrix Tri Mode Printer  PC-8221A* Battery Operated Portable Thermal Printer  Other NEC Printers*  IBM Graphic Printer and its compatibles Most of the other parallel or serial printers* are compatible with the PC-8300. * Special-effect printing commands are not supported by all printers in the TEXT mode.	Cable PC-8494A necessary Cable included with PC-8221A Cable PC-8494A necessary Check at the store
<b>Monitors</b> You can use NEC monochrome composite monitors for the PC-8300 with the CRT Adapter PC-8241A-K.	The PC-8241A-K is available only in the United States.



Accessories	Description
<p><b>Cables</b>            For Telecommunications</p> <p>PC-8495A-01 RS-232C Cable (normal)            PC-8495A-02 RS-232C Cable (reverse)            PC-8361A 300 Baud Modem Card            PC-8399A-02 Phone Cable</p> <p>Other cables for peripherals</p> <p>PC-8494A Printer Cable            PC-8493A CMT (Cassette Magnetic Tape) Cable</p>	<p>Optional            Optional            Optional            included with PC-8361A*            * The PC-8361A is available only in the United States.</p>
<p><b>Power Supply</b>            PC-8271A-01* AC Adapter</p> <p>*The PC-8271A-01 is for the area where the outlet power is 120V. Contact the store where you purchased your PC-8300 for other AC Adapters.</p> <p>PC-8301A-90 or PC-8201A-90 NiCd Battery Cartridge</p>	<p>Optional              Optional</p>
<p><b>Other accessories and software not available from NEC</b>            Bar code reader            Application programs for PC-8201A or PC-8300</p>	<p>Recommended models</p>

## E.2 Connection of Peripherals

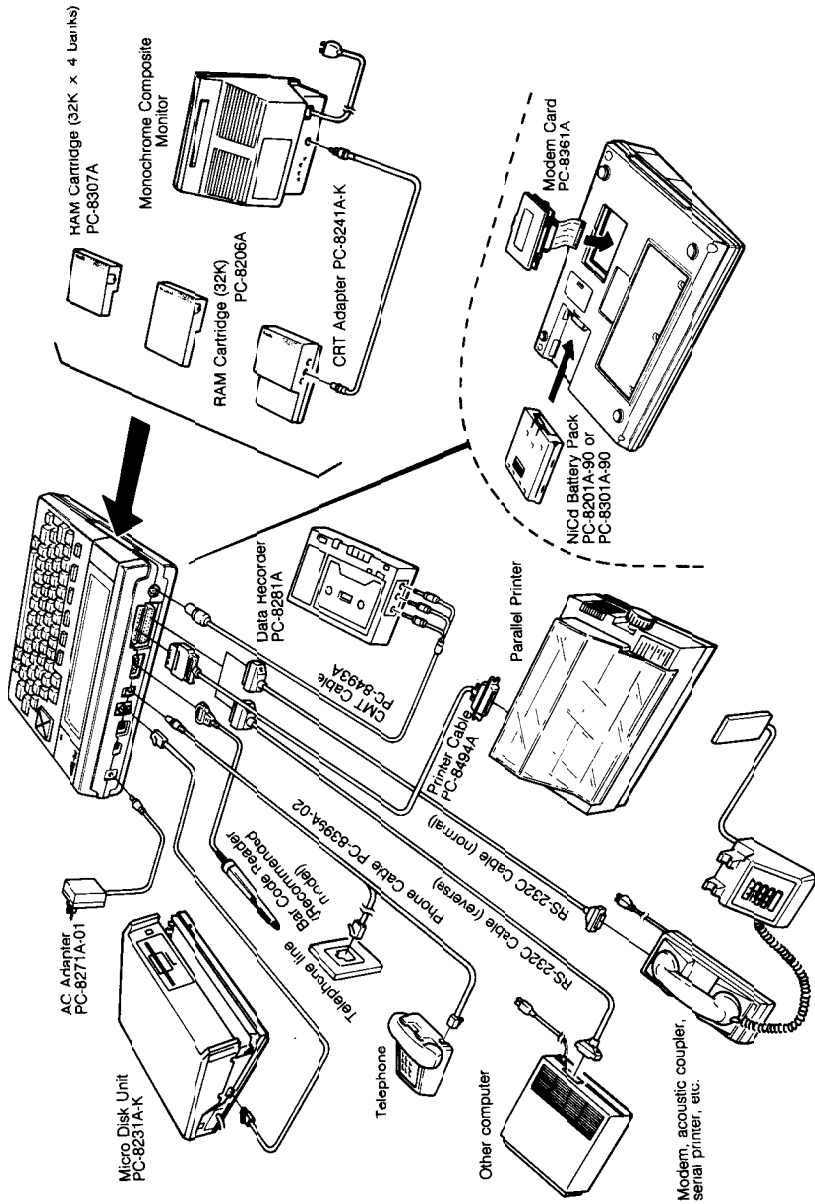

## APPENDIX F

# SWITCHING THE CHARACTER SET

The PC-8300 has an ASCII standard keyboard, but it can be used as a German or British keyboard by switching the jumper socket inside the bottom lid of the PC-8300. Follow these steps to change the character set:

1. Save all files you want to keep from the RAM onto an external storage device such as a cassette tape, floppy disk, etc.).
2. Turn the power of the PC-8300 off.

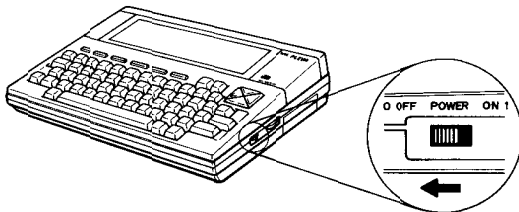

3. Turn the BACK-UP POWER switch to the OFF position. All the files in the RAM will be erased by this.

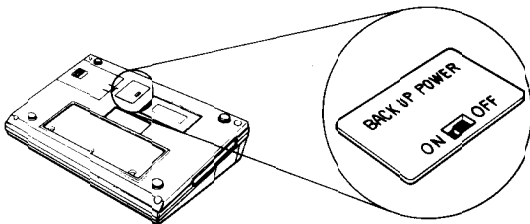

4. Using a screwdriver, take off the largest lid on the bottom of the PC-8300.

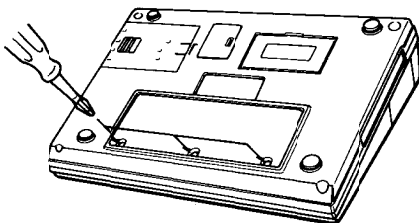

5. You can see two jumper switches at the right side of the ROM socket.

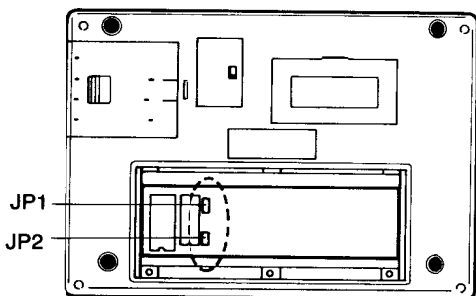

6. Reset the jumper switch by using a needle-nosed pliers or something similar to the figure below:

for U.S.



for German



for British

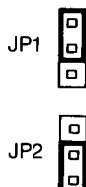

7. Close the lid as before by using the screwdriver.
8. Turn the BACK-UP POWER switch to the ON position again.
9. Turn on the PC-8300.
10. Perform a cold start (while holding **SHIFT CTRL**, press RESET on the rear of the PC-8300. Release the RESET switch and then release **SHIFT CTRL**).
11. You should test the keyboard by entering either the BASIC or TEXT mode.
12. We recommend that you switch the character labels or mark the keytops themselves, so you will not be confused by the labels on the keytops not matching the characters which result when you press the keys.

Please contact your nearest NEC dealer if you cannot switch the character sets.

Differences Between The U.S., German, and British Keyboards

ASCII character set

(U. S. A.)

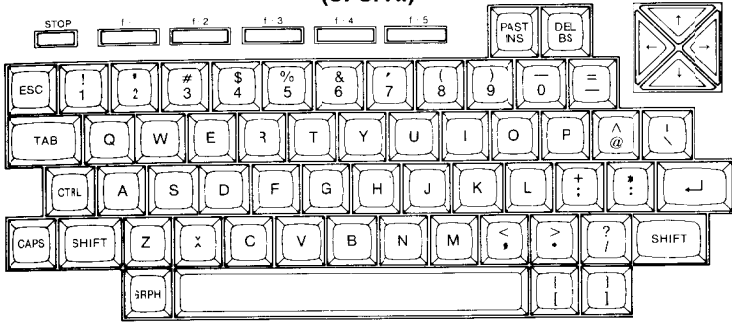

German character set

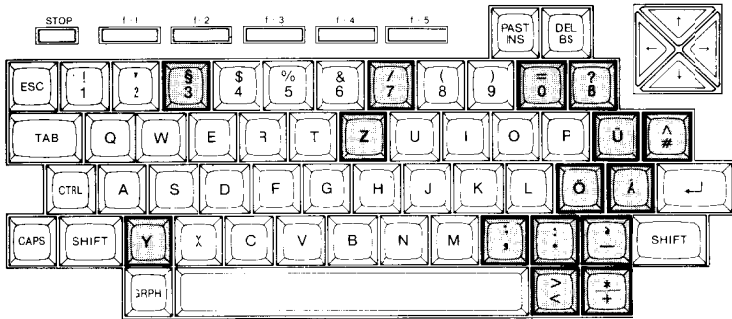

British character set

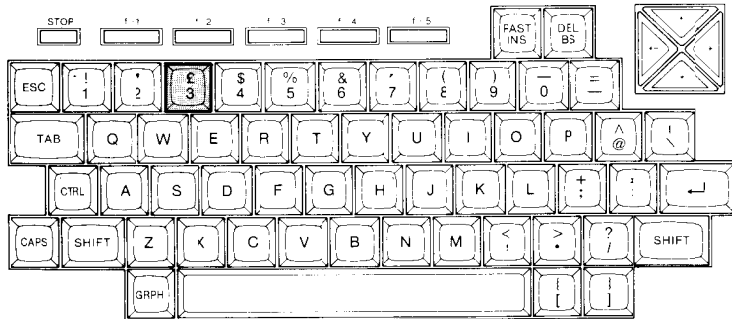

US ASCII Character Set

	2	3	4	5	6	7	8
0		!	@	P	'	p	4
1	!	1	A	Q	A	q	↓
2	"	2	B	R	B	r	☒
3	#	3	C	S	C	s	
4	\$	4	D	T	D	t	
5	%	5	E	U	E	u	
6	&	6	F	V	F	v	
7	'	7	G	W	G	w	
8	(	8	H	X	H	x	
9	)	9	I	Y	I	y	
A	*	:	J	Z	J	z	
B	+	;	K	[	k	{	
C	,	<	L	/			
D	-	=	M	]	m	}	
E	.	>	N	^	n	~	
F	/	?	O	_	o		

German Character Set

	2	3	4	5	6	7	8
0		!	§	P	'	p	4
1	!	1	A	Q	A	q	↓
2	"	2	B	R	B	r	☒
3	#	3	C	S	C	s	
4	\$	4	D	T	D	t	
5	%	5	E	U	E	u	
6	&	6	F	V	F	v	
7	'	7	G	W	G	w	
8	(	8	H	X	H	x	
9	)	9	I	Y	I	y	
A	*	:	J	Z	j	z	
B	+	;	K	Ä	k	ä	
C	,	<	L	Ö	l	ö	
D	-	=	M	Ü	m	ü	
E	.	>	N	^	n	ß	
F	/	?	O	_	o		

United Kingdom Character Set

	2	3	4	5	6	7	8
0		!	@	P	'	p	4
1	!	1	A	Q	A	q	↓
2	"	2	B	R	B	r	☒
3	£	3	C	S	C	s	
4	\$	4	D	T	D	t	
5	%	5	E	U	E	u	
6	&	6	F	V	F	v	
7	'	7	G	W	G	w	
8	(	8	H	X	H	x	
9	)	9	I	Y	I	y	
A	*	:	J	Z	J	z	
B	+	;	K	[	k	{	
C	,	<	L	/			
D	-	=	M	]	m	}	
E	.	>	N	^	n	~	
F	/	?	O	_	o		

# APPENDIX G

## SWITCHING TO THE PC-8201A MODE

The NEC PC-8201A is the previous model of the PC-8300. The PC-8300 is designed as an enhanced version of the PC-8201A. Therefore, you can use all the application software for the PC-8201A on the PC-8300. However, there are some software packages which need some preparation before use.

If the application software you have doesn't work properly, switch your PC-8300 to the PC-8201A mode by following the steps below.

1. Do a Cold Start

While pressing **SHIFT** and **CTRL** together and push the reset button at the back of the PC-8300. All your programs and files in the PC-8300 memory will be cleared (BASIC, TEXT, and TELCOM will of course remain intact). Please refer to Chapter 3.2 for a detailed explanation of "Cold Start".

2. Enter the BASIC mode

Press **↵** when the directory cursor in the MENU mode is on BASIC. The start-up message of BASIC appears on the screen.

```

NEC PC-8201 BASIC Ver 1.1 (C) Microsoft
25596 bytes free
Ok
█

Load " Save " Files List Run
  
```

3. Execute OUT instruction in BASIC

Type the BASIC instruction listed below and the press **↵** to execute it.

**OUT '63,2**

The "Ok" sign appears just below that command. Now your PC-8300 is in the PC-8201A mode.



In the PC-8201A mode, the modem function cannot be utilized. Even if you set the optional modem into PC-8300.

In the PC-8201A mode, the PC-8300 enhanced formatting capability in the TEXT mode cannot be used.



If you do a cold start in the PC-8201A mode, the PC-8300 returns to its original mode. To go back to the PC-8201A mode, execute an OUT instruction in BASIC again.

### **How to Return to the PC-8300 Mode**

Do a cold start. The PC-8300 always returns to its original PC-8300 mode every time a cold start is executed.



---

# APPENDIX H

## GLOSSARY

---

<b>ASCII</b>	American Standard Code for Information Interchange.
<b>ARRAY</b>	A set of values arranged in a regular pattern such as in single file or in two dimensions.
<b>BASIC</b>	Beginner's All-purpose Symbolic Instruction Code. Easy to understand programming language.
<b>DATA</b>	Information such as numbers, names etc. that a computer must have in order to solve a given problem or to do a certain job.
<b>DELIMIT</b>	Separate.
<b>FILE</b>	A collection of data to be used with a computer program. Programs also are often called files.
<b>INPUT</b>	To send information to the computer, for example by pressing keys on the keyboard.
<b>K</b>	A KiloByte, 1024 bytes (2 raised to the 10th power) which is used to measure memory capacity in computers. One typed page, double spaced, is equivalent to about 2K.
<b>LINE NUMBER</b>	An identifying number that is placed ahead of each BASIC statement in a program.
<b>MEMORY</b>	The part of a computer which stores data or information. There are two main types of memory, Random Access Memory (RAM) which is temporary and is used for what we input to the computer; Read Only Memory (ROM) is permanent memory, and normally programs such as computer control software are written on ROM chips.
<b>OUTPUT</b>	What a computer sends out, such as the result of a program, a printed document etc.
<b>PROGRAM</b>	A set of instructions telling a computer how to solve a given problem or do a specific job. The instructions are organized in a certain sequence in a programming language such as BASIC, FORTRAN, COBOL, etc.
<b>RAM</b>	Random Access Memory. Temporary memory that can be altered, by means of saving files or new programs or running programs.
<b>RETURN KEY</b>	A key on the terminal's keyboard that is used to complete the users input to the computer, such as entering a BASIC statement.

- RESERVED WORD** in BASIC, the first word of a statement that identifies the type of statement.  
For example: LET, IF, GO TO, PRINT, etc.
- ROM** Read Only Memory. The type of memory that stays intact even when the PC-8300's power is turned off. The user cannot change it, only read it and use it.
- STATEMENT** A single instruction to the computer such as 10 LET P=42.6

# APPENDIX I

## LIST OF NEC SERVICE OFFICES

If your NEC equipment does not work properly, even though you operate it in the correct manner as described in this manual, refer to your nearby NEC representative. The representatives of NEC listed below will be glad to give you any assistance they can.

Offices	Address	TEL Number
NEC Home Electronics (U.S.A.) Inc.	1225 Michael Drive Wood Dale, IL. 60191-1094	312-860-9500
NEC Business Systems (Europe) Ltd.	35 Oval Road London NW1 7EA England	01-267-7000
NEC Home Electronics (Europe) GmbH	Wiesenstr. 148 4040 Neuss, 1 West Germany	(02101) 278-0
NEC Informaton Systems Australia Pty, Ltd.	99 Nicholson Street St. Leonards, N.S.W. 2065, Australia	02-438-3544
NEC Computers Singapore Pte. Ltd.	138 Robinson Road Hong Leong Finance Bldg., #11-10 Singapore	2259288
NEC Business Systems (HK) Limited	Rm 910-917 Tower B Mandarin Plaza 14 Science Museum Rd. Tsimshatsui East Kowloon, Hong Kong	3-690335
NEC Corporation	NEC Building 33-1 Shiba Gochome Minato-ku, Tokyo Japan 108	03-454-1111

# INDEX

## A

- AA batteries 18
- AC Adapter 9, 16, 18, 22
  - Power Pack 114
- adjustment of contrast 25
- alkaline batteries 21
- ASCII format 66
- audio tapes 84
- automatic shut-off 27

## B

- BA, file-type 51, 64
- back of PC-8300 16
- back-up power 17, 24, 35
  - power switch 17
- backspace ( BS ) 28, 30
- backup.n82 121
- bank #, MENU 47
- bank #1 37, 76
  - cold start 37
  - 38, 41
- bank #2
  - cold start 38
  - memory protection 40
- bank #3 38, 40, 76
  - cold start 38
  - memory protection 40
- BANK command 48, 76
- banks
  - of RAM 34, 47
  - with internal RAM 77
  - with RAM Cartridge 77
- bar code reader BCR 16
- BASIC 8, 48, 84
  - editing 50
  - interpreter 8
  - mode, loading/saving 34
  - Reference Card 5
  - Reference Manual 5

- batteries,
  - changing 27
  - information 107
  - life 21, 23, 107
  - need to replace 27
  - packs 15
  - precautions 108
  - replacement 27, 107
- battery power indicator 15, 27
- BCR bar code reader 16, 127
  - port 16
- binary format 66
- BLOCK switch 9, 105
- booting, disk code 118
- bootstrap sequences 118
- bottom of PC-8300 17
- BS key (backspace key) 28, 30
- built-in
  - programs, starting 55
  - software 48, 55

## C

- cable
  - CMT for data recorder 10
  - computer-to-computer 10
  - for data recorder 10
  - for FDD 10
  - for modem use 10
  - for parallel printer 10
- capacity of RAM memory 34
- CAPS key 28, 29
- Cartridge,
  - NiCd Battery 17, 18, 23
  - Expansion RAM 34
- CAS 63
- caution 3
  - NiCd Battery Cartridge 20
  - use of cables 11

centronics parallel printer  
changing batteries 27  
character codes 143  
  set, switching 147  
CLR IPL command 48, 74  
CMT interface cable 4, 8, 10  
  port 16  
CO file-type extension 51  
cold start 16, 26, 36, 106  
.COM 63

commands, MENU 48  
components, family of 8  
computer-computer 10, 16  
  cable 10  
connecting computers 16  
  Data Recorder 82  
contrast adjustment 15, 25  
CRT adapter 7, 8  
  monitor 126  
CTRL C 3  
  key 3, 28, 29  
cursor keys 28, 30

## D

Data Recorder 9, 81  
  recorder interface cable 10  
date and time, MENU 47  
DATES 52, 53  
DELEte key 28, 30  
device name 63, 67  
digital tapes 86  
directory area, MENU 47  
  cursor, MENU 47  
disk, micro floppy 112, 115  
disk drive 8, 10, 16, 109  
interface cable 10  
  port 16  
disk unit  
  connection 113  
  with N82-BASIC 121  
DO file-type extension 51 64  
do's and don'ts v  
document file 56

Download Aborted error 52

## E

ESCape key 28, 29  
escaping from hang-up 16  
expansion RAM cartridges 34  
external modem 99, 100

## F

f.1 to f.5 key 29  
f.6 to f.10 key 29, 31  
family of components 8  
FCC rules 11  
FDD 10, 16, 111  
FDD cable 10  
FDD port 16  
file names 51, 63, 67  
file-type extensions 51, 64  
files 50, 71  
?FL error 52  
floppy disk drive unit 10  
format.n82 121  
front of PC-8300 15  
function keys 15, 28, 31

## G

glossary 153  
graphics symbols 31  
GRP-H key 28, 31

## H

hardware specifications 130  
hung up 16, 41, 42

## I

I/O Interface 135  
initialize (clear) 36, 106  
initializing  
  bank #3 106  
  RAM 37  
INSert key 28, 30

insertion, floppy disks 122  
interface cable, recorder 10  
internal RAM capacity 34  
IPL command file 37, 72, 73

## K

keyboard 15, 28  
keys, special 28  
KILL command file 48, 75

## L

labelling disks 123  
LCD 8, 15  
life of batteries 21, 23  
LIST command 48, 70  
Lithium batteries 35  
LOAD command 48, 61, 119  
LOAD file from disk 119  
loading prompt 63  
LOW BATTERY LED 15, 27

## M

main power supply options 18  
maintenance,  
    data recorder 86  
    micro disk unit 124, 125  
    printer 90, 91  
manual, using this 2  
manuals 4, 5  
memory capacity 34  
    map 141  
    PROTECT switch 16  
    protection 16, 39, 105  
    protection of bank #3 40  
    protection of bank #2 40  
MENU 8, 26, 47, 57, 83  
    commands 48  
    executing 57  
    exiting to 57, 58  
    mode, loading/saving 83  
    screen 26  
    with disk unit 119  
Micro Disk Unit 7, 10, 16, 110

cable 10  
maintenance 124  
PC-8231A-K 10  
port 16

micro floppy disk 112, 122  
Microsoft BASIC 48  
modem cable 10  
    Card, PC-8361-A 8  
modem-telephone cable 10  
modular jack of disk unit 16  
monitor, composite 7  
monochrome monitor 7

## N

N82-BASIC:  
    Reference Card 5  
    Reference Manual 5  
    with disk unit 121  
NAME command file 48, 69  
NEC service offices 155  
NiCd back-up battery 24  
NiCd battery cartridge 9, 18, 23  
Nickel-Cadmium batteries 23  
?NM error 51

## O

opening a document file 56  
operating system MENU 8  
optional accessories 144  
    features of PC-8300 7  
    Modem Card (PC-8361A) 50, 93  
options, main power supply 18

## P

parallel printer port 16  
    printer cable 10  
    printer 10, 16, 88  
parts of PC-8300 6, 15  
password protection, IPL 74  
PASTE key 28, 30  
PC-8201A mode, switching 151  
PC-8201A-90 NiCd Battery  
    Cartridge 9  
PC-8206A RAM Cartridge 9, 34

- PC-8206A memory protection 39
- PC-8207A RAM Cartridge 7, 9, 34, 39
- PC-8207A memory protection 39
- PC-8231A 7, 10, 16, 110, 115
- PC-8231A-K 8
- PC-8241A-K 8
- PC-8271A-01 AC adapter 9, 22
- PC-8281A Data Recorder 9, 81, 86
- PC-8298A FDD cable 10
- PC-8300
  - meeting your 14
  - optional features 7
  - parts of 6
  - standard features 6
- PC-8301A-90 NiCd Battery Cartridge 9
- PC-8361-A Modem Card 7, 10
- PC-8399A-02 Phone Cable 10
- PC-8406A 7
- PC-8493A CMT Cable 10
- PC-8494A Printer Cable 10
- PC-8495A-01 RS-232C Cable (normal) 10
- PC-8495A-02 RS-232C Cable (reverse) 10
- peripheral devices, other 8, 79
- personal application kit 4
  - computers, others 96
- Phone Cable PC-8399A-02 10
  - cable port 16
- power, turning on/off 25
- POWER command 27, 49
- CONT command 27
- power supply, main 18
  - supply, options 18
  - switch 15, 17
  - switch back-up 17
- preparing cassette tape 33
  - Data Recorder 83
- print out,
  - BASIC mode 90
  - MENJ mode 89
  - TELCOM mode 90
  - TEXT mode 90
- printer 10, 87, 90
  - cable, parallel 10
  - connecting 88
  - maintenance 90
  - port 16
  - preparing 89
  - printing interruption 71
    - out, LIST command 71
    - out data 89
    - out files 89
  - programs, built-in 55
  - PRTECT switch 16, 40
  - protection of RAM 39

## Q

- questionnaire 4

## R

- RAM, initializing 37
  - banks 9, 34
  - capacity 34
  - memory protection 39
- RAM Cartridge: 7, 34, 102
  - BLOCK switch 9
    - connecting 102, 103
    - disconnecting 104
  - memory protection 39
  - operating 105
  - FC-8206A 32K 9
    - power supply 105
  - recharging NiCd battery 23
    - with AC adapter 9
- REMEMBER 3
  - replacement of batteries 27
- RESET, cold start 16, 41
  - switch 16, 41
- return key 28, 30
- reverse cable, PC-8495A-02 10
  - cable for RS-232C 10
- ROM-based TELCOM 50

RS-232C, other equipment 98  
interface 50  
reverse cable 10  
serial port 16, 96  
straight cable 10

## S

SAVE, file to disk 120  
command 48, 65, 67  
file promot 67  
screen 8  
selecting a RAM bank 9  
serial printer port 16  
printer 16, 88  
SE^IPL command 48, 72  
setting date 52  
time 52  
shielded cables 11  
SHIFT key 28, 31  
shut-off, automatic 27  
signal connector 113  
signs and symbols 3  
?SN error 54  
space bar 3  
special keys 15, 28  
standard batteries 21  
features of PC-8300 6  
STOP key 28, 29  
straight cable 10  
cable for RS-232C 10  
cable PC-8495A-01 10  
switch, RESET 16  
for BACK-UP POWER 17  
for memory PROTECTION 16  
symbols, signs and warnings 3

## T

TAB key 23, 29  
tapes, audio 84  
care & handling 84  
digital 83  
TELCOM 5, 8, 27, 50  
manual 5

terminal mode 27  
telecommunications 93  
telephone-modem cable 10  
terminal mode of TELCOM 27  
tests, cables used in 11  
TEXT 49  
manual 5  
TIMES 52, 54  
troubleshooting:  
battery 109  
data recorder 87  
micro disk unit 125, 126  
Modem Card 100, 101  
printer 91, 92  
turning power on/off 25, 26

## U

unpacking 4  
unshielded cables 11  
User's Guide 5  
using AC adapter 22  
utility disk 121  
program, backup.n82 121  
program, format.n82 121  
program, xfiles.n82 121

## W

warm/cold start 35  
warranty cards 4  
word-wrap 71



## **Bescheinigung des Herstellers/Importeurs**

**Hiermit wird bescheinigt, daß der/die/das**

Personalcomputer PC-8300 mit PC-8221A, FC-8281A, PC-8231A, PC-8207A,  
PC-8206A.....

**(Gerät, Typ, Bezeichnung)**

**In Übereinstimmung mit den Bestimmungen der**

DBP Vfg. 1046/1984.....

**(Amtsblattverfügung)**

**funk-entstört ist**

**Der Deutschen Bundespost wurde das Inverkehrbringen dieses  
Gerätes angezeigt und die Berechtigung zur Überprüfung der Seite  
auf Einhaltung der Bestimmungen eingeräumt.**

NEC Home Electronics (Europe) GmbH.....

**Name des Herstellers/Importeurs**

**NEC**

Printed in Japan  
78118252