

 Roland

MT-100
DIGITAL SEQUENCER
AND SOUND MODULE

Owner's Manual

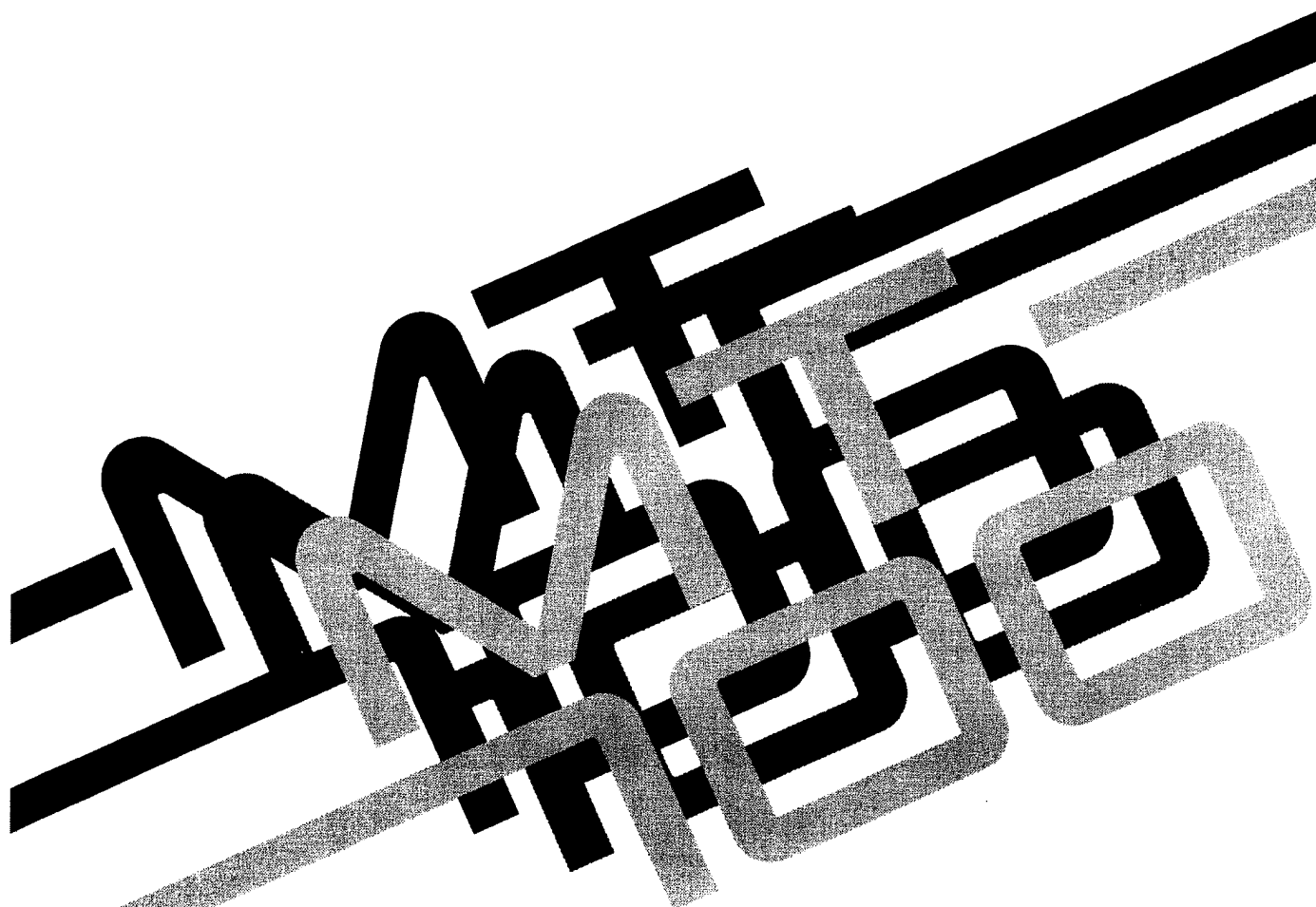

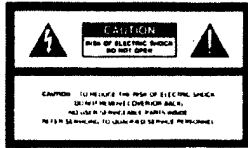

The lightning flash with arrowhead symbol, within an equilateral triangle, is intended to alert the user to the presence of un-insulated "dangerous voltage" within the product's enclosure that may be of sufficient magnitude to constitute a risk of electric shock to persons.

The exclamation point within an equilateral triangle is intended to alert the user to the presence of important operating and maintenance (servicing) instructions in the literature accompanying the product.

INSTRUCTIONS PERTAINING TO A RISK OF FIRE, ELECTRIC SHOCK OR INJURY TO PERSONS.

IMPORTANT SAFETY INSTRUCTIONS

WARNING When using electric products, basic precautions should always be followed, including the following:

1. Read all the instructions before using the product.
2. Do not use this product near water- for example, near a bathtub, washbowl, kitchen sink, in a wet basement, or near a swimming pool, or the like.
3. This product should be used only with a cart or stand that is recommended by the manufacturer.
4. This product, either alone or in combination with an amplifier and headphones or speakers, may be capable of producing sound levels that could cause permanent hearing loss. Do not operate for a long period of time at a high volume level or at level that is uncomfortable. If you experience any hearing loss or ringing in the ears, you should consult an audiologist.
5. The product should be located so that its location or position does not interfere with its proper ventilation.
6. The product should be located away from heat sources such as radiators, heat registers or other products that produce heat.
7. The product should avoid using in where it may be affected by dust.
8. The product should be connected to a power supply only of the type described in the operating instructions or as marked on the product.
9. The power-supply cord of the product should be unplugged from the outlet when left unused for a long period of time.
10. Do not tread on the power-supply cord.
11. Do not pull the cord but hold the plug when unplugging.
12. When setting up with any other instruments, the procedure should be followed in accordance with instruction manual.
13. Care should be taken so that objects do not fall and liquids are not spilled into the enclosure through openings.
14. The product should be serviced by qualified service personnel when:
 - A: The power-supply cord or the plug has been damaged; or
 - B: Objects have fallen, or liquid has been spilled into the product; or
 - C: The product has been exposed to rain; or
 - D: The product does not appear to operate normally or exhibits a marked change in performance; or
 - E: The product has been dropped, or the enclosure damaged.
15. Do not attempt to service the product beyond that described in the user-maintenance instructions. All other servicing should be referred to qualified service personnel.

SAVE THESE INSTRUCTIONS

ADVARSEL !

Lithiumbatteri. Eksplosionsfare.
Udskiftning må kun foretages af en sagkyndig,
og som beskrevet i servicemanual.

VARNING !

Lithiumbatteri. Explosionsrisk.
Får endast bytas av behörig servicetekniker
Se instruktioner i servicemanualen.

ADVARSEL !

Lithiumbatteri. Fare for eksplosion.
Må bare skiftes av kvalifisert tekniker som
beskrevet i servicemanualen.

VAROITUS !

Lithiumparisto. Räjähdyksvaara.
Pariston saa vaihtaa ainoastaan
alan ammattimies.

WARNING

THIS APPARATUS MUST BE EARTH GROUNDED.

The three conductors of the mains lead attached to this apparatus are identified with color as shown in the table below, together with the matching terminal on the UK type power plug. When connecting the mains lead to a plug, be sure to connect each conductor to the correct terminal, as indicated. "This instruction applies to the product for United Kingdom."

MAINS LEADS		PLUG
Conductor	Color	Mark on the matching terminal
Live	Brown	Red or letter L
Neutral	Blue	Black or letter N
Grounding	Green-Yellow	Green, Green-Yellow, letter E or symbol

Bescheinigung des Herstellers / Importeurs

Hiermit wird bescheinigt, daß der/die/das

ROLAND DIGITAL SEQUENCER MT-100

(Typ- und Bezeichnung)

in Übereinstimmung mit den Bestimmungen der

Amtsbl. Vfg 1046 / 1984

(Anschlußverfügung)

funkentstört ist

Der Deutschen Bundespost wurde das Inverkehrbringen dieses Gerätes angezeigt und die Berechtigung zur Überprüfung der Serie auf Einhaltung der Bestimmungen eingeräumt.

Roland Corporation Osaka / Japan

Name des Herstellers/Importeurs

RADIO AND TELEVISION INTERFERENCE

Warning - This equipment has been verified to comply with the limits for a Class B computing device pursuant to Subpart J, of Part 15, of FCC rules. Operation with non-certified or non-verified equipment is likely to result in interference to radio and TV reception.

The equipment described in this manual generates and uses radio frequency energy. If it is not installed and used properly, that is, in strict accordance with our instructions, it may cause interference with radio and television reception.

This equipment has been tested and found to comply with the limits for a Class B computing device in accordance with the specifications in Subpart J, of Part 15, of FCC Rules. These rules are designed to provide reasonable protection against such interference in a residential installation. However, there is no guarantee that interference will not occur in a particular installation. If the equipment does cause interference to radio or television reception, which can be determined by turning the equipment on and off, the user is encouraged to try to correct the interference by the following measures:

- Disconnect other devices and their interconnect cables one at a time. If the interference stops, it is caused by either the other device or its I/O cable.
- These devices usually require Roland designated shielded I/O cables. For Roland devices, you can obtain the proper shielded cable from your dealer. For non-Roland devices, contact the manufacturer or dealer for assistance.
- If your equipment does cause interference to radio or television reception, you can try to correct the interference by using one or more of the following measures:
 - Turn the TV or radio antenna until the interference stops.
 - Move the equipment to one side or the other of the TV or radio.
 - Plug the equipment into an outlet that is on a different circuit than the TV or radio. (This is, make certain the equipment and the radio or television set are on circuits controlled by different circuit breakers or fuses.)
 - Consider installing a rooftop television antenna with coaxial cable lead in between the antenna and TV.

If necessary, you should consult your dealer or an experienced radio/television technician for additional suggestions. You may find helpful the following booklet prepared by the Federal Communications Commission:

"How to Identify and Resolve Radio-TV Interference Problems"

This booklet is available from the U.S. Government Printing Office, Washington, D.C. 20402. Stock No. 004-000-00345-4

Please read the separate volume "MIDI", before reading this owner's manual.

Copyright © 1988 by ROLAND CORPORATION

All rights reserved. No part of this publication may be reproduced in any form without the written permission of ROLAND CORPORATION.

FEATURES

The Roland MT-100 is a real-time digital sequencer with a built-in multi-timbral sound module, releasing you from complicated setups and operation. With the MT-100, the following functions are possible.

- Recording is carried out in Real-Time.
- The memory capacity of the MT-100 is 17,000 notes of music data.
- Up to two tracks can be used to record polyphonic MIDI information, Program Change, Pitch Bend messages, etc. A further two tracks can be recorded on by using advanced functions.
- The MT-100 has REC, PLAY, STOP, BWD (◀◀) and FWD (▶▶) buttons which function just like those found on a cassette player/recorder.
- You can Punch-IN and overdub on the existing music data while it is being played back.
- The data recorded on two individual tracks can be merged into one of the tracks.
- When playing back the recorded data, you can mute any track, adjust the tempo, even Transpose.
- The music data recorded on the MT-100 can be saved and loaded onto 2.8 inch QD's (Quick Disks) with the convenient built-in Disk Drive.
- The multi-timbral sound module section works like eight independent synthesizers and one rhythm machine, allowing you to enjoy ensemble style performance with only one MT-100.
- The MT-100 stores 128 different preset tones and 30 preset rhythm tones.
- The digital reverbration section can create reverb effect.
- The Alpha-DIAL serves for quick operation.
- The MT-100 is provided with a display window (LCD) which is used to display information and help in operating.

For Canada

CLASS B

NOTICE

This digital apparatus does not exceed the Class B limits for radio noise emissions set out in the Radio Interference Regulations of the Canadian Department of Communications.

CLASSE B

AVIS

Cet appareil numérique ne dépasse pas les limites de la classe B au niveau des émissions de bruits radioélectriques fixés dans le Règlement des signaux parasites par le ministère canadien des Communications.

Panel Description

Front Panel

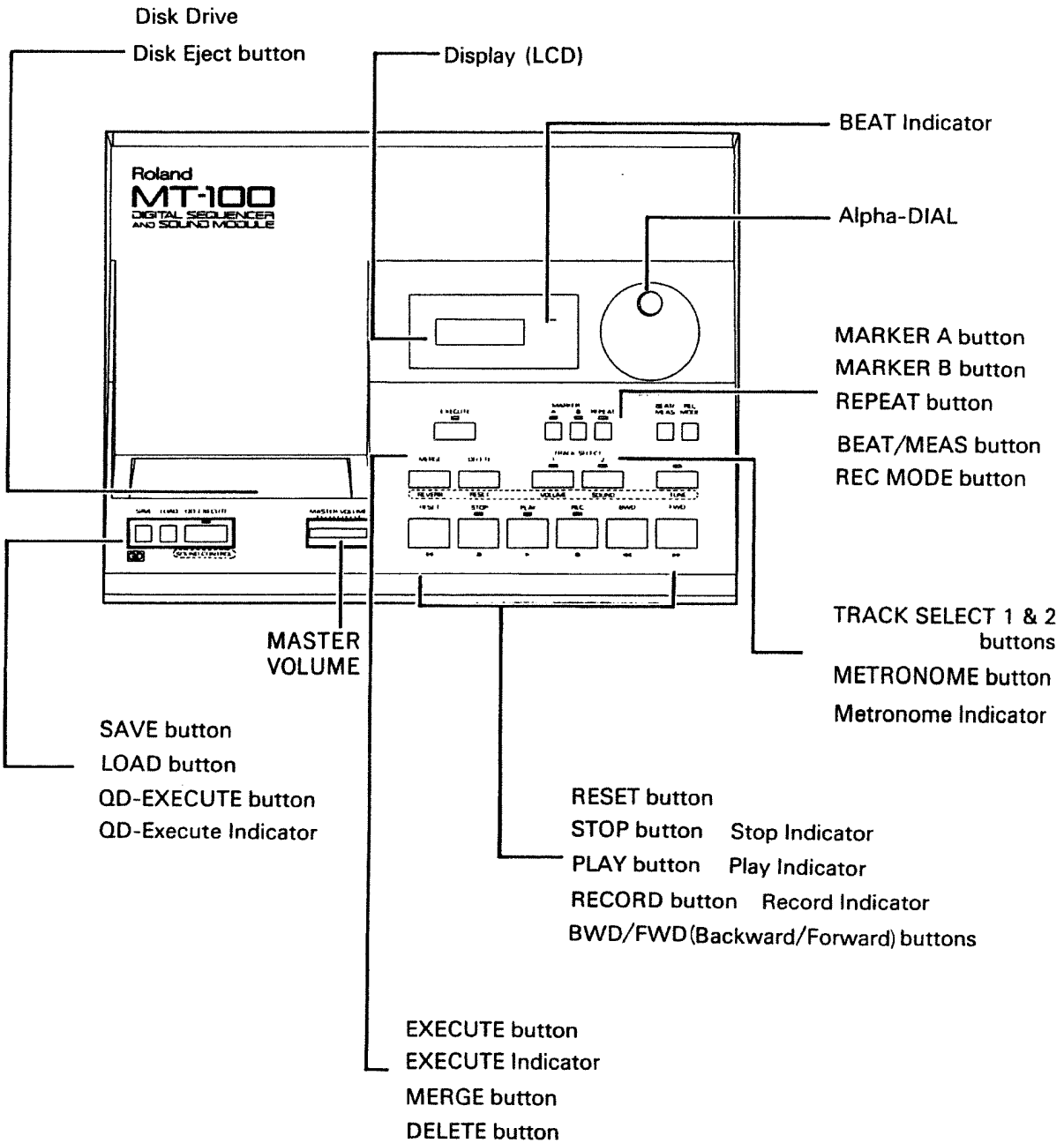

2. Rear Panel

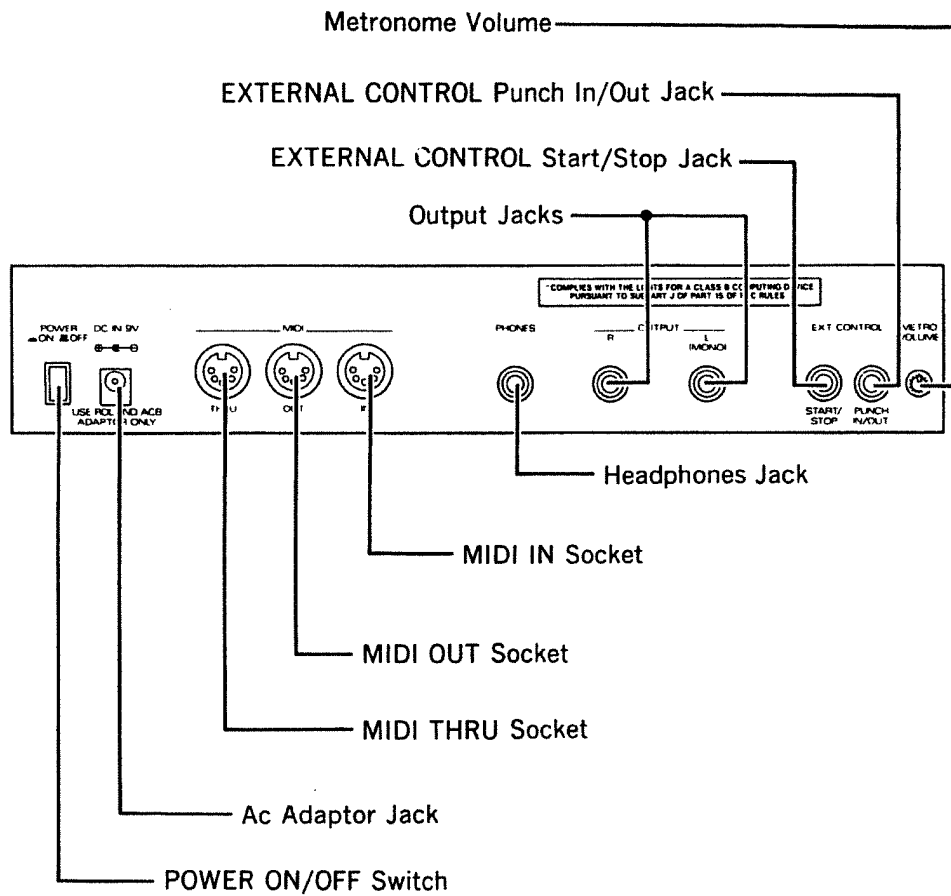

CONTENTS

To ensure the best use and full enjoyment of your MT-100, please read this guide carefully and thoroughly.

THE CARE OF YOUR MT-100	6
CONNECTIONS	8
Connecting up with a MIDI Keyboard	8
ROM PLAY	9
QUICK DISK (QD)	10
Quick Disk Care	11
GETTING STARTED	12
PLAYBACK THE SAMPLE DISK	15

HOW TO USE MT-100 FEATURES - PART 1

RECORDING	16
Key-on-Start	16
Manual Start with Count-In	17
FOOT SWITCH Start	18

OVERDUBBING	19
METRONOME	20
BEAT Indicator	20
BEAT/MEASURE	21

PLAYBACK	22
Forward/Backward (FWD/BWD)	22
Tempo change	23
Track Mute	23
MARKERS A & B	24
- Set	24
- Jump	24
- Cancel	24
- REPEAT	25

OPTIONAL MODES	26
Transpose	26
Restore original Tempo	27
Sub Tracks	27
Mute Sub Tracks	28
Auto metronome count-in	28
Start/Stop Playback with FOOT SWITCH	29

HOW TO USE MT-100 FEATURES - PART 2

EDIT	30
Delete	30
Merge (combine)	30
PUNCH-IN/OUT RECORDING	31
- using MARKER A & B	32
- using Foot Switch	33
Recording from the middle or end of a song	35
Recording Non-Note Information	35
QUICK DISK (QD)	36
Quick Disk Care	36
Quick Disk (QD) - Load	36
Quick Disk (QD) - Save	37
Playback Pre-recorded QD's	37
Sound Select	39
Volume for each part	39
Reverb mode	40
Master Tuning	40
All Controller Reset	41
Sound data correction	41
Write Sound Setup into Sequencer data	41
Clear Sound Setup in the Sequencer data	42
Partial and Maximum Voices	42
MIDI CONFIGURATION MEMORY	43
Summary MIDI parameters/values	49
ERROR MESSAGES	50
Explanation of Error Messages	50
ADVANCED OPTIONAL MODES	51
QUANTIZE	51
All Clear	53
Memory Consumption	53
PAUSE MARK	53
PAUSE MARK Set	54
PAUSE MARK Delete	54
Jump PAUSE MARK	54
QD - OPTIONAL MODES	55
QD-Model check	55
QD-Verify	55
Exchange Tracks and SAVE	56

THE CARE OF YOUR MT-100

ROOM LOCATION

Avoid using this unit in excessive heat or humidity conditions or where it may be affected by direct sunlight or dust and avoid places subject to high vibrations.

CABINET CARE

Use a soft dry cloth for dusting. To remove fingerprints or dulling film, use a soft cloth slightly dampened with water and a little mild detergent. Immediately wipe dry with a soft cloth. Do not use solvents such as paint thinners.

CHECK LIST

IF YOUR MT-100 FAILS TO OPERATE:

Make sure that the AC adaptor is firmly plugged into the jack at the rear and that the AC adaptor is not faulty. Also check that the AC wall outlet is not faulty. Plug in a lamp or radio to test the wall outlet.

Be sure the ON/OFF switch is ON.

Make sure that the MT-100 has been correctly connected through MIDI to other MIDI devices.

In the event the instrument is still inoperable, your Roland technician or dealer is best qualified to provide you with competent service. Do not attempt any adjustments or repairs by yourself.

When the display responds with a different indication from any explained in this manual, refer to "ERROR MESSAGES" in PART 2.



PRECAUTIONS

The appropriate power supply for the AC adaptor unit is shown on its name plate. Please make sure that the line voltage in your country meets the requirement.

Use only the AC adaptor provided.

Please do not use the same socket used for any noise generating device (such as a motor, variable lighting system).

Disconnect the AC adaptor immediately in the event of an electrical storm.

Before setting up this unit with other MIDI devices, turn this unit off along with all other units.

Be sure to connect the MIDI cable securely. If the MIDI cable is disconnected while the MT-100 is being played, various troubles will occur (e.g. the sound would not stop).

Static electricity may cause the build-in computer to malfunction. Should this occur, simply reset the computer by turning the power switch off and then after a few seconds, back on.

This unit might not operate correctly if turned on immediately after being turned off. If this happens, simply turn it off and after a few seconds later, turn it on again.

Operating this unit near a neon, Fluorescent lamp, TV or CRT Display, may cause noise interference. If so, change the angle or the position of the unit.

This unit could get heated while operating, but there is no need to be concerned.

The built-in Disk Drive of the MT-100 is a precision machine. So, please handle it carefully.

To avoid risk of electric shock, do not perform any servicing. Refer all servicing to qualified service personnel.

CONNECTIONS

Connecting up with a MIDI Keyboard

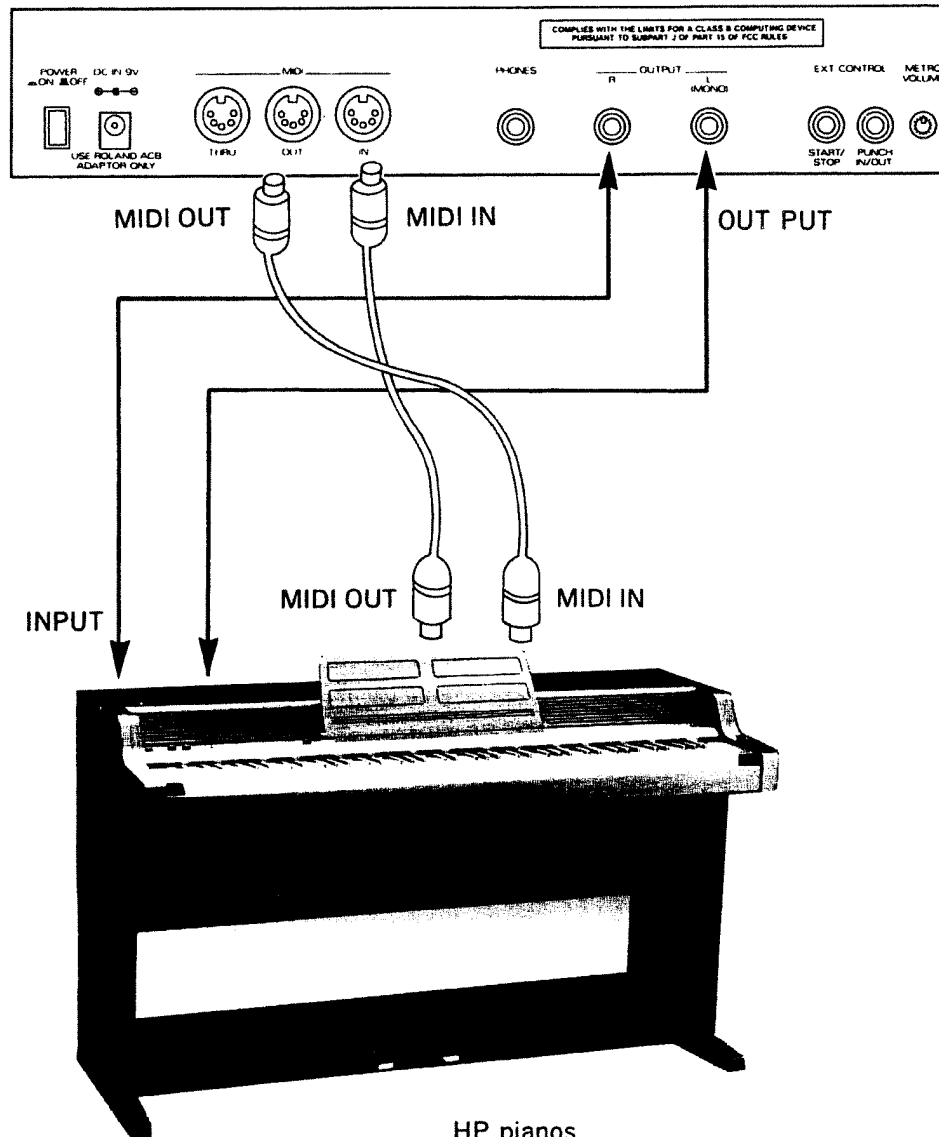

NOTE

The supplied MIDI cable is specifically for MIDI connection. Do not use it for any other connection such as DIN Sync or audio setup.

HP pianos
e.g. 3000S/4500S/5500S/5600S/6000
HP-600/700/800

*Before connecting the MT-100 to the keyboard, turn both units off.

ROM PLAY

Five different songs are programmed in the MT-100 in order to demonstrate the effect of the Multi Timbral function. When playing these songs, please use a stereo amplifier (HP pianos) if possible, to obtain the best effect of the Multi Timbral functions.

(1) Press PLAY button while keeping SOUND-CONTROL button pressed, to enter into 'ROM PLAY' mode.
"RANDOM"

(2) Press FWD/BWD button or rotate the Alpha-DIAL to select the song number.

- "RANDOM"
- "CHAIN"
- "SONG 1"
- "SONG 2"
- "SONG 3"
- "SONG 4"
- "SONG 5"

(3) Press PLAY to play.

(4) Press STOP or RESET to stop.

(5) press REST button while keeping SOUND-CONTROL button pressed, to return the MT-100 to 'Stand By' mode.

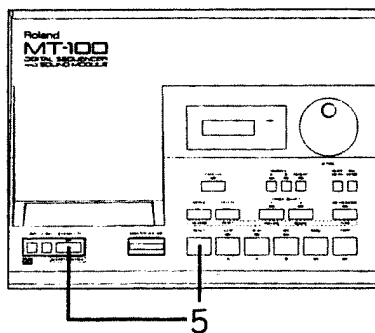
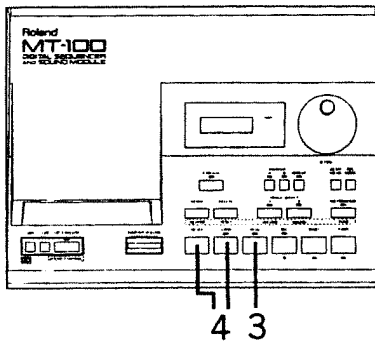
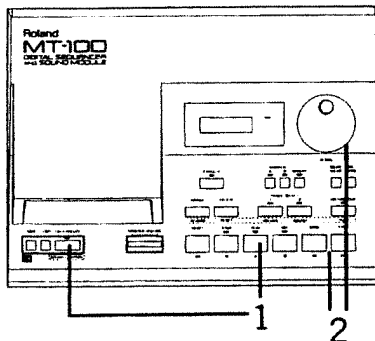

Song Number	Song Name	
Song 1	Boiler Buster	Music by Adrian Scott(c) 1988 by Adrian Scott
Song 2	Sinfonia 1	Composed by J.S. Bach
Song 3	Adjarre	Music by Eric Persing(c) 1988 by Eric Persing
Song 4	Short Demo	Music by Adrian Scott(c) 1988 by Adrian Scott
Song 5	Good Morning	Music by Phill Curry(c) 1987 by Phill Curry Music

NOTE: During ROM PLAY mode, you cannot play the sequencer or play the keyboard.

NOTE: The performance data of the ROM PLAY is not sent through the MIDI OUT Connector.

QUICK DISK (QD)

After recording your performance on the MT-100, the data can be stored onto a 2.8 inch Quick Disks (QD's) using the built-in Disk Drive. The memory capacity of a QD is approx. 8,500 notes on each side.

Quick disks are delicate and can be damaged if not handled properly. Disks could also become erased naturally after a certain length of time. To ensure a long life for your data disks, be sure to follow the instructions.

Instructions on handling Quick Disks

Do not touch the magnetic disk

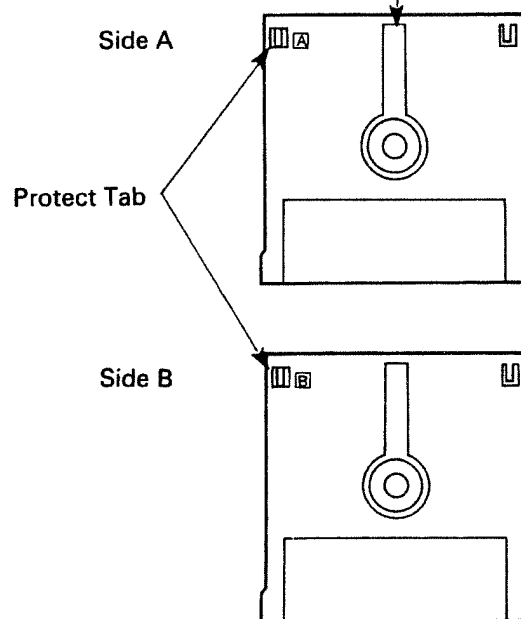

* To prevent accidental loss of data after saving onto the QD, be sure to break off the plastic tab next to the indicated side (A or B). To rewrite data on a protected QD, place adhesive tape over the slot next to the indicated side (A or B) as shown below.

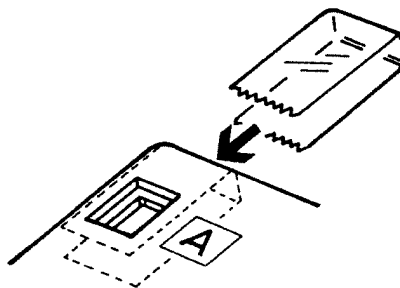

Quick Disk Care

Do not touch the magnetic disk.

Do not use the disk where it may be affected by dust.

Do not use the disk near anything magnetic such as headphones or speakers.

Keep disks away from extremely hot and cold temperatures.

To avoid accidental loss of data, be sure to remove the Protect tab on the disk.

Never remove or insert the disk, or switch the MT-100 OFF or ON while the QD-Execute Indicator is lit, or the disk may become erased.

The MT-100's internal memory cannot read the data recorded on a damaged disk, so we recommend that you should make copies of your important data.

One blank 2.8 inch Quick disk (QD) has been supplied with the MT-100 to store your performance on. You may purchase additional QD's from your local Roland dealer, or obtain a high-quality Quick Disk as an alternative.

The following pages of easy-to-follow instructions will help you to get started on the MT-100.

HANDLING PROCEDURE FOR EJECTING QD

When you wish to remove the QD, please press the Eject Button.

If you try to take out the QD without pressing the Eject Button, the pad applied to the disk drive will be damaged, causing breakdown.

If the QD does not come out, push the Eject Button again.

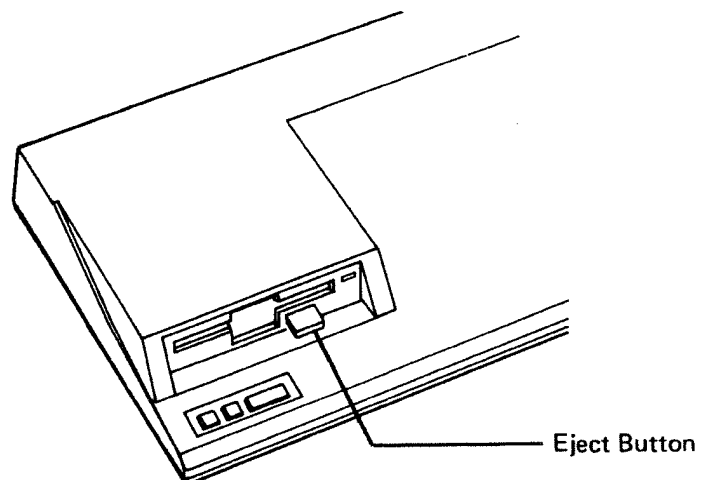

GETTING STARTED

1. Make sure you have followed the "Connecting up with a MIDI keyboard" procedure on (Page 8).
2. Turn on the MIDI keyboard.
3. Power on the MT-100.
Press the POWER switch on the rear panel ON
The display will read "MT-100" as the instrument readies itself for operation. In just two seconds the display will change to "1 120", letting you know that the MT-100 is ready for you to use.

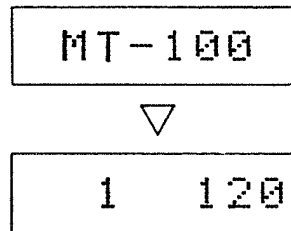
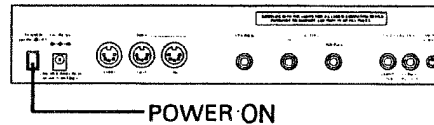

4. Press REC button. LED of REC button will light and LED's of TRACK SELECT 1 and 2 will begin to flash.
5. As you are going to record the right hand to the following music first, press TRACK SELECT 2 button. LED of TRACK SELECT 2 button will stay lit and LED of PLAY button will begin to flash.

Automatically the MT-100 will start recording by pressing a key on your MIDI keyboard.

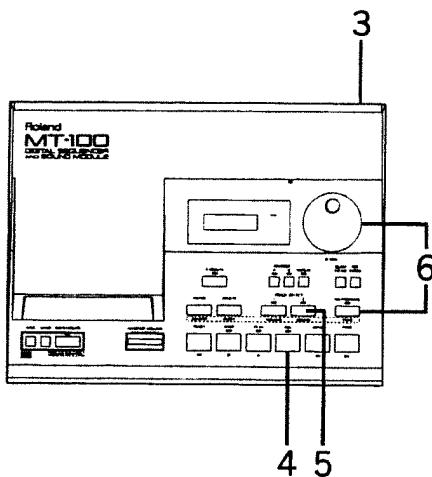

6. To help you to keep perfect time during recording, the MT-100 is equipped with a built-in Metronome. Press METRONOME button, LED will light. To record "Air On the G String" at the correct tempo, simply rotate the Alpha-DIAL counter-clockwise until the display reads "1 100".

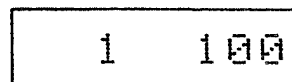
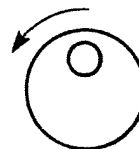

(Make sure the volume of the Metronome is turned up fully. Rotate the METRONOME VOLUME control on the rear of the PR-100 clockwise.)



7. Play the right-hand melody alone. Simply match the melody notes to the corresponding keys. Count as you play.

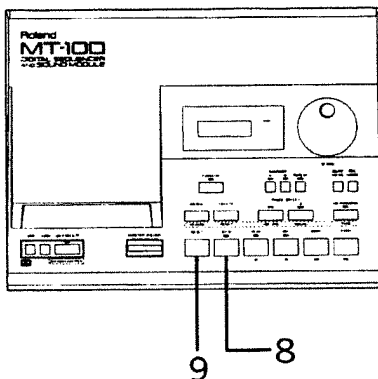

8. Press STOP button. TRACK SELECT 2 LED will stay lit verifying that there is music data recorded there.
9. Press RESET button. Display will revert back to read:

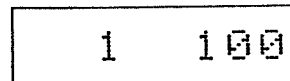

NOW, ADD THE ACCOMPANIMENT...

Now you are going to record the left-hand to accompany the right-hand melody you have just recorded.

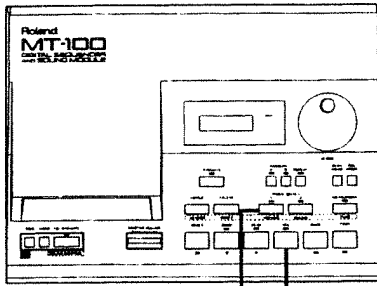

11 10

10. Press REC button, LED will light and TRACK SELECT 1 & 2 will begin to flash. (Track 1 red, Track 2 red & green alternately.)
11. Press TRACK SELECT 1. Red LED will stay lit and LED of PLAY will begin to flash.
12. Play the left-hand accompaniment according to the indicated notes. (While recording the accompaniment you will automatically hear your recorded melody playing back.)

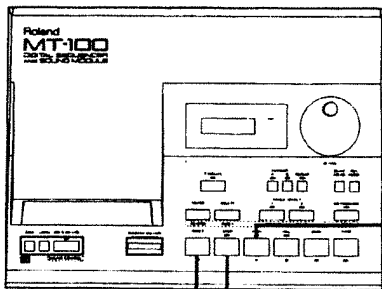

14 13

13. Press STOP button. TRACK SELECT 1 LED will now stay lit verifying that there is music data recorded there.
14. Press the RESET button. The display will revert back to read:

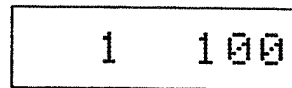

15. To replay "Air On the G String" PLAY button. (The MT-100 automatically stop at the end of the playback.)

PLAYBACK THE SAMPLE DISK

To help you with this initial recording, the "Sample Disk" which accompanied your MT-100 contains the tune "Air on the G string" pre-recorded for Roland Piano with the MT-100's accompaniment.

- 1) Insert Side A into the Disk Drive.
 - 2) Press LOAD button, QD. EXECUTE LED will begin to flash.
 - 3) Press QD-EXECUTE button to load Side A into the internal memory of the PR-100, A beep is heard when loading is completed.
 - 4) Press the PLAY button
- If you wish to stop the playback, simply press the STOP button.
 - To play back the data again from the beginning, press the REST button, then the PLAY button.

Also included on the Sample Disk are three additional examples of recorded music. (All these tunes are selected from the "ISM MUSIC LIBRARIES". The "ISM MUSIC LIBRARIES" are available at your Roland dealer.)

	Start Measure	Title	Track 1	Track 2	Sub Track 3	Sub Track 4
DISK A-1	1	Air On The G String		MT-100 Accomp	Piano L.H.	Piano R.H.
DISK A-2	48	Liebstraume No.3(Liszt)		MT-100 Accomp	2nd Piano (Accomp)	1st Piano (Melody)
DISK A-1	1	The Nutcracker Overture Miniature	MT-100 Melody	MT-100 Counter Melody	MT-100 Obbligato	MT-100 Bass
DISK B-2	120	Czerny Technical Studies op.849 No.1			Piano L.H.	Piano R.H.

●Accomp; Accompaniment ●L.H.; Left Hand ●R.H.; Right Hand

- If you wish to playback the next song, press the FWD button once while holding down the stop button, then press the PLAY button.
- If you wish to playback the preceding song, press the BWD button once while holding down the STOP button. Doing this while a song is being played will return to the beginning of that song.
- If you wish to play back the song on the side B, push the Eject button to remove the QD, and insert the disk with side B facing upwards.
Then repeat step 2),3) to load side B into the MT-100.

NOTE: MT-100 consists of Tracks 1 to 4. When playing back the recorded data, you can mute any tracks. See page 23 "Track Mute".

HOW TO USE MT-100 FEATURES - PART 1

1. RECORDING

The MT-100 will record MIDI information in real time from any MIDI keyboard and will record all the nuances of your performance exactly as you play them. To find out which performance parameters your particular instrument can send and/or receive through MIDI, check the MIDI implementation chart in your instrument's Owner's Manual.

The MT-100 will record information on all sixteen MIDI channels. When you are recording, the MT-100 will record the set channel number of the MIDI keyboard you are using.

Multi-timbral instruments allow you to play more than one sound simultaneously. Instruments that are not multi-timbral can only play back one sound at one time. The MT-100 cannot perform beyond the capabilities of the instrument you are using. If your instrument is multi-timbral, you can play back different parts simultaneously on different MIDI channels.

Make sure you have followed the "Connecting up with a MIDI keyboard" procedure on (Page 8).

a) Key-On-Start Recording: (REC MODE is set for "REAL")

- (1) Press REC MODE button. Display will indicate "REAL" or "PUNCH".

Real

Punch

If the display reads "PUNCH", rotate the Alpha-DIAL until "REAL" is displayed. Press EXECUTE button. A beep will sound and the display will revert to "1 120".

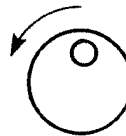

Real

- (2) Press REC button. REC LED will light and TRACK SELECT buttons 1 & 2 will begin to flash.
- (3) Press TRACK SELECT button 1 or 2, to put MT-100 in REC 'Stand By'. TRACK SELECT LED of button pressed will stay lit and PLAY button LED will begin to flash.

(To help you to keep perfect time during recording, the MT-100 is equipped with a built-in Metronome. See METRONOME.)

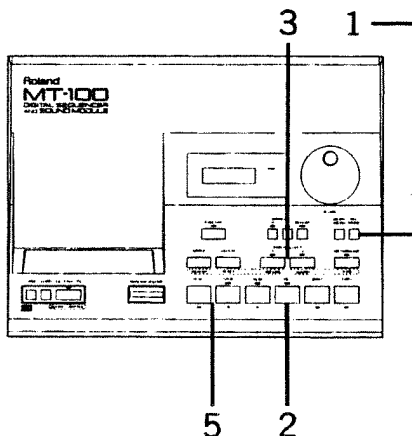

- (4) Play your MIDI keyboard. The MT-100 will start recording automatically.



- (5) Press STOP button or RESET button to stop recording.

b) Manual Start with Count-In Recording: (REC MODE is set for "REAL")

- (1) Press REC MODE button. Display will indicate "REAL" or "PUNCH". If the display reads "PUNCH", rotate the Alpha-DIAL until "REAL" is displayed. Press EXECUTE button. A beep will sound and the display will revert back to "1 120".

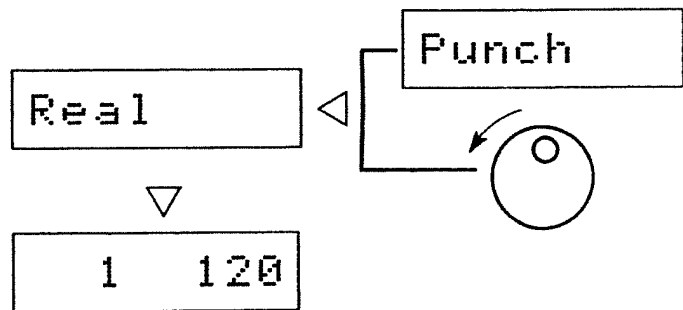

- (2) Press REC button. REC LED will light and TRACK SELECT buttons 1 & 2 will begin to flash.
- (3) Press TRACK SELECT button 1 or 2, to put MT-100 in REC 'Stand By'. TRACK SELECT LED of button pressed will stay lit and PLAY button LED will begin to flash.

(To help you to keep perfect time during recording, the MT-100 is equipped with a built-in Metronome. See METRONOME.)

- (4) Press PLAY button to start recording. Recording will automatically begin after a two-measure count-in.

- (5) Play your MIDI keyboard at the 2 measure count-in.



- (6) Press the STOP button or RESET button to stop recording.

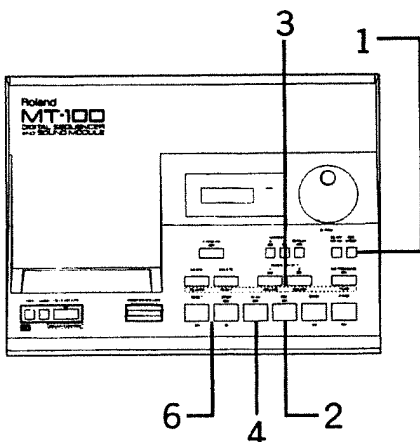

c) FOOT SWITCH Start Recording: (REC MODE is set for "REAL")

(Make sure the Foot Switch "DP-2" (optional) is connect to the jack on the rear of the MT-100)

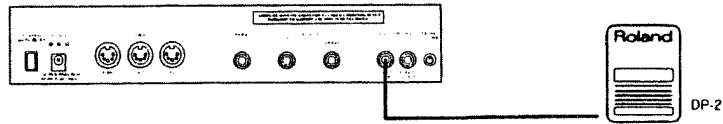

- (1) Press REC MODE button. Display will indicate "REAL" or "PUNCH". If the display reads "PUNCH", rotate the Alpha-DIAL until "REAL" is displayed. Press EXECUTE button. A beep will sound and the display will revert to "1 120".

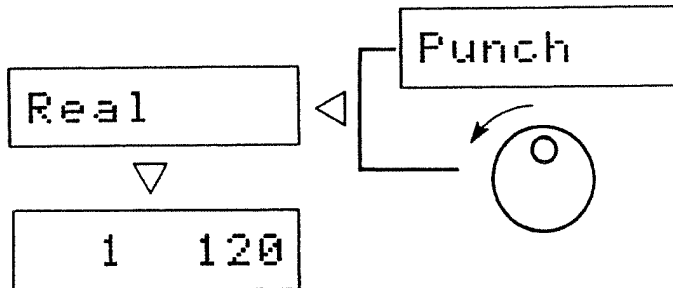

- (2) Press REC button. REC LED will light and TRACK SELECT buttons 1 & 2 will begin to flash.

- (3) Press TRACK SELECT button 1 or 2, to put MT-100 in REC 'Stand By'. TRACK SELECT LED of button pressed will stay lit and PLAY button LED will begin to flash.

(To help you to keep perfect time during recording, the MT-100 is equipped with a built-in Metronome. See METRONOME.)

- (4) Press the Foot Switch (DP-2) to start recording. Recording starts immediately.

- (5) Play your MIDI keyboard.



- (6) Press Foot Switch (DP-2), STOP button or RESET button to stop recording.

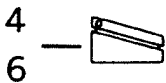
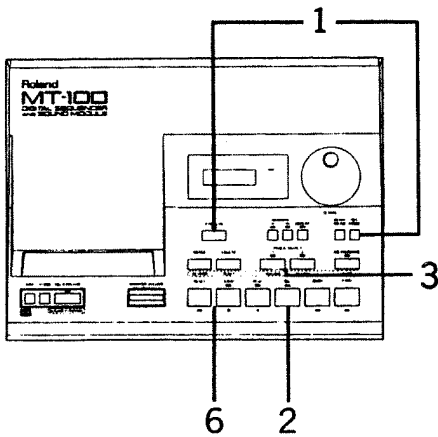

NOTE: If the memory becomes full during recording, the display will respond with "Full". This means that no more notes can be recorded.

2. OVERDUBBING

After recording on one Track, you may record data on another Track either from the beginning, middle or end of the first tracks composition. This is called "Overdubbing". The MT-100 will allow you to hear the data on the other track while you record a new part.

- (1) Position the song at the measure where you wish overdubbing to start using BWD/FWD buttons.
(Make sure the MT-100 is in "REAL" recording mode.)

20 120

- (2) Press REC button.
- (3) Press TRACK SELECT button 1 or 2, to select the empty track for overdubbing and to put the MT-100 in REC 'Stand By'.
- (4) Press PLAY button to start recording (overdubbing).

The two previous measures will play during the count-in. If you are overdubbing from the beginning of the song, you will hear a two-measure count-in from the Metronome and the display will count down two measures" - 2" then " - 1".

-2 120



-1 120

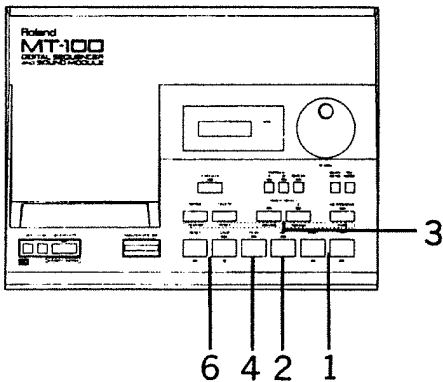

- (5) Play your MIDI keyboard after the 2 measure count-in.

Measure Count

-2 , -1 ▶



- (6) Press STOP button or RESET button to stop recording.

You can mute (silence) the other track if you do not want to hear it while recording simply by pushing the relevant TRACK SELECT button. (The LED will be turned off). This procedure does not erase the previously recorded data, therefore, pushing the TRACK SELECT button again will recall the sound recorded in that Track.

NOTE: If you do not want a count-in before recording (overdubbing). Just start to play on the MIDI keyboard. Recording will start automatically.

NOTE: You may overdub on a track that is not blank. However, all the information you record will replace the previous recorded data.

d) METRONOME

To help you to keep perfect time during recording, the MT-100 is equipped with a metronome. The down-beat of each measure is indicated by a higher pitched beep.

- (1) Press METRONOME. LED will light.
Now when recording, a metronome sound can be heard.
Metronome sound can also be enabled on playback.

To adjust the volume of the Metronome, rotate the METRONOME VOLUME control situated on the rear of the MT-100. (Clockwise for louder, counterclockwise for softer.)

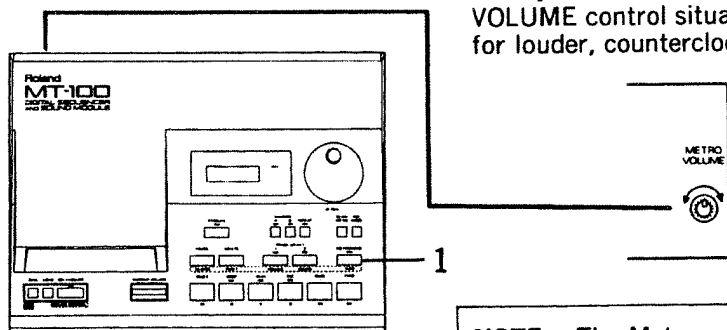

NOTE: The Metronome sound is mixed with sound output.

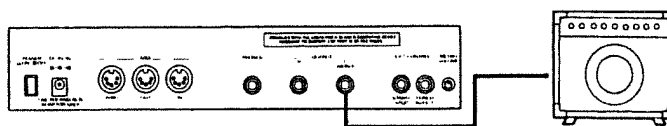

NOTE: The Metronome will also play during the two measure count-in on "Manual Start with Count-In Recording".

e) BEAT Indicator

A further aid in time-keeping is the BEAT indicator LED at the right-hand side of the display. When in 'Stand By' mode, the indicator flashes green. In Recording or Playback mode, the BEAT indicator LED will visually count out the measure or beat for you by flashing in sequence. The first beat of the measure flashes red, while the following beats flash green.

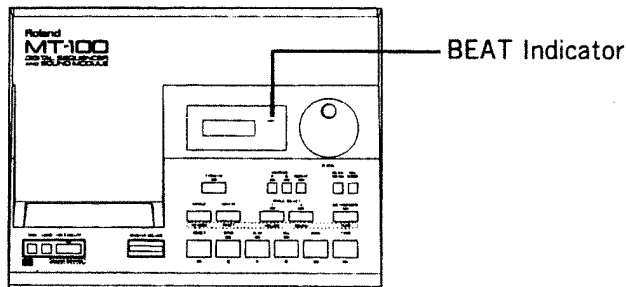

f) BEAT/MEAS - to set time signature for new measures to record

Upon turn-on of the MT-100, the time-signature automatically preset for recording (default value) is 4/4.

If you wish to record in another time signature:

BPM = 4/4

- (1) Press BEAT/MEAS button. The display will indicate "BPM=4/4" (default value). EXECUTE button LED will begin to flash. Rotate the Alpha-DIAL to change values.

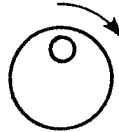

Clockwise for 5/4
6/4
7/4
8/4
1/2
2/2
3/2
4/2

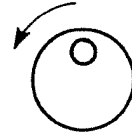

Counterclockwise for 3/4 9/8
2/4 8/8
1/4 7/8
16/8 6/8
15/8 5/8
14/8 4/8
13/8 3/8
12/8 2/8
11/8 1/8
10/8

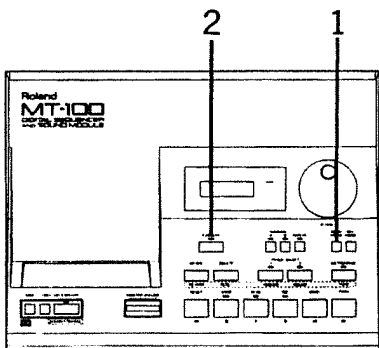

- (2) Press the EXECUTE button to execute the change and return the MT-100 to 'Stand By' mode. (The MT-100 being switched off, any changed value is cancelled.)

or

Press the STOP button to cancel any change of BEAT/MEAS and return the MT-100 to 'Stand By' mode.

For cancellation of any changed value while in the BEAT/MEAS mode, simply press BEAT/MEAS button.

NOTE: The time signature can be changed numerous times in any one recording.

3. PLAYBACK

The recorded sequencer data can be played on any MIDI instrument connected to the MT-100.
Make sure you have followed the "Connecting up with a MIDI key-board" procedure on (Page 8).

- (1) Press RESET button to return the song to Measure 1.
- (2) Press PLAY button to playback music data. The LED of the PLAY button lights and the recorded data will be played back.

(When all the data is played back, the indicator of the PLAY button is turned off and the MT-100 automatically stops.)

- (3) To stop the playback before the end of the song, press the STOP button and the MT-100 will stop playing and return to the 'Stand-By' mode.

(Press the PLAY button again will start the playback and continue from the point that it was stopped.)

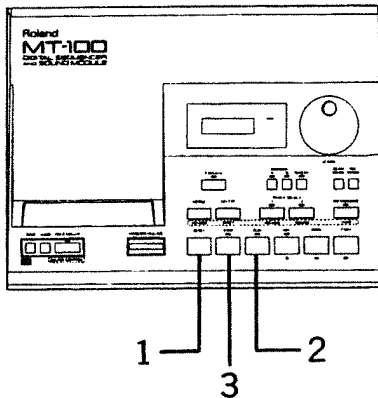

NOTE: If you wish to stop playing the data before the end of the song and go back to the first bar at the same time, press the RESET button instead of the STOP button. The MT-100 will immediately stop and will reset to Measure 1.

a) Forward/Backward (FWD/BWD)

The FWD/BWD buttons operate similar to the controls you already are familiar with on a cassette player/recorder. Pressing FWD button once will move the position of the song by one measure forward, press the BWD button once will move the position by one measure backward. Holding the FWD or BWD buttons down will "scroll" (move) the position of the song rapidly forward or backwards respectively.

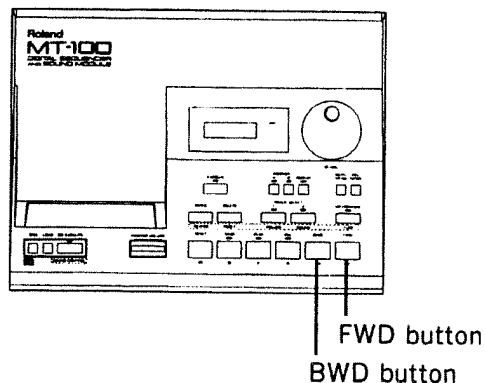

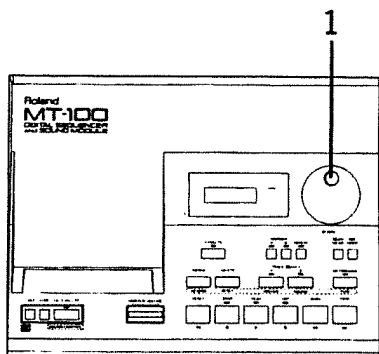

b) Tempo Change

During playback, the tempo can be changed.

- (1) Rotate the Alpha-DIAL clockwise to quicken the tempo and counterclockwise to slow down the tempo of the playback. The display will indicate the new tempo which has been set.

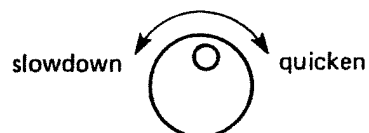

The number shown in the display indicates how many quarter notes are played within one minute.

NOTE: The tempo can also be changed - faster or slower while the MT-100 is stopped ('Stand By' mode).

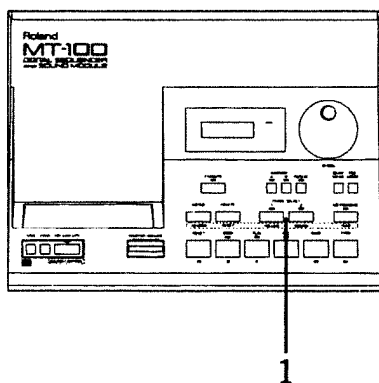

c) Track Mute

Track 1 or Track 2 can be muted (silenced) during playback.

- (1) Press TRACK SELECT button 1 or 2. The LED of the muted track will be turned off.

To hear a track which has been muted, simply press the same TRACK SELECT button again. LED will light and the track will be heard.

NOTE: Track muting can also be carried out while the MT-100 is stopped ('Stand By' mode).

NOTE: If the LED is not lit of Track 1 or 2 before muting, this means that there is no data recorded in that track.

NOTE: Any data you have recorded or any pre-recorded data in Subtracks 3 & 4 can also be muted. See "Mute Subtracks".

d) MARKERS A & B

Two 'Markers' can be inserted anywhere during the song. These markers can be used to:

- instantly search for a particular point in the song, backward or forward.
- manually repeat the playback from a particular point.
- manually jump from one point to another anywhere during the song.

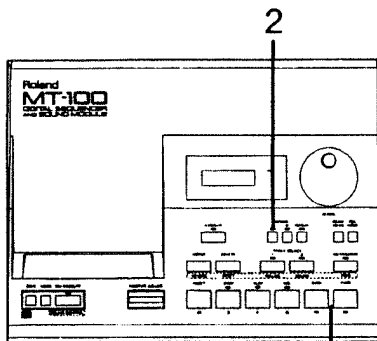

e) Set MARKER A & B

MARKERS A & B can be inserted at the beginning of a measure or anywhere in between.

To set MARKER A at the beginning of measure:

- (1) Go to the desired measure by FWD/BWD buttons. The display will indicate measure number.
- (2) Press MARKER A button. LED of MARKER A will light, and MARKER A is now set.

Repeat operation 1 & 2 to set a second Marker (MARKER B).

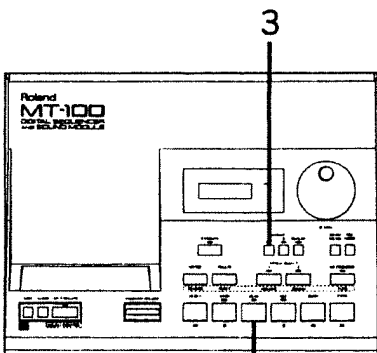

To set MARKER A at any point during a measure:

- (1) Position the song a few measures before the point you wish to insert the marker.
- (2) Press PLAY. Playback of the song will occur.
- (3) While the song is being played back, press MARKER A button at the precise point in the song you wish the marker to be. LED of MARKER A will light and MARKER A is now set.

Repeat operation 1, 2 & 3 to set a second marker (MARKER B).

NOTE: Both MARKER A and MARKER B can be set in the same song, however MARKER B cannot be set before the position in the song of MARKER A.

NOTE: Marker A & B settings are memorized when saving data onto a QD.

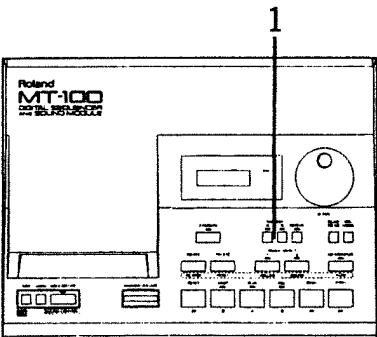

f) Jump to MARKER

To jump to MARKER A or B:

- (1) Press the lit MARKER button A or B. The MT-100 will immediately respond and jump to the desired position (MARKER A or B). This can be achieved if you are before or after that position.

NOTE: Jumping to MARKER A or B can be carried out while stopped ('Stand-By' mode) or while playback is in progress.

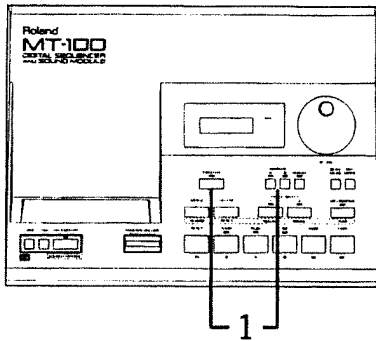

g) Cancel MARKER A or B

To cancel a set MARKER A or B,

- (1) Press MARKER button A or B while pressing EXECUTE button. LED of the pressed button will be turned off and the Marker will be cancelled.

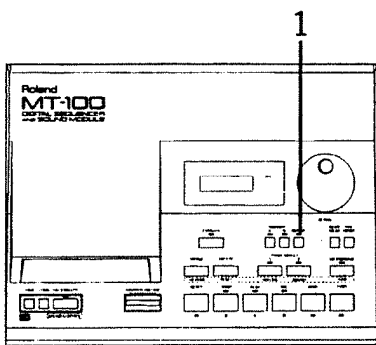

h) Repeat MARKER A or B

Any section of the recording can be repeated automatically on playback.

- (1) Press REPEAT button. LED will light. On playback, the song will automatically repeat:

- a) from the beginning of the song
- if no markers are set

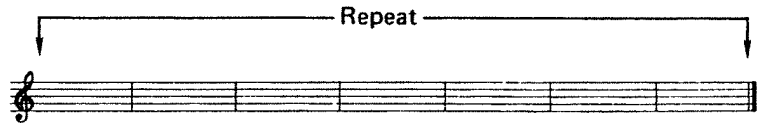

- b) from MARKER A to the end
- if MARKER A is set

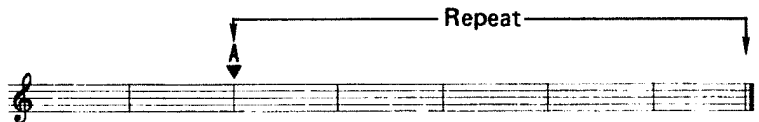

- c) from the beginning to MARKER B
- if MARKER B is set

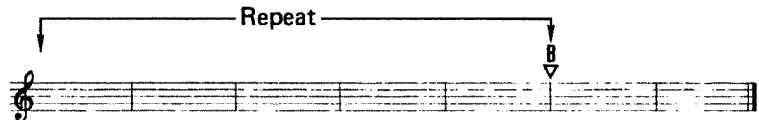

- d) from MARKER A to MARKER B
- if MARKER A & B are set.

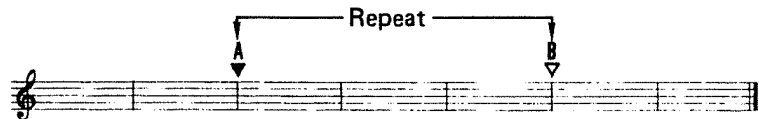

To cancel the REPEAT function, press REPEAT button, LED will be turned off.

a) Transpose - playback key

The Transpose function shifts the pitch (note) up or down by half-steps (Semitones). The transposition range on the MT-100 is two octaves up or down. Transposition can be applied to all the data or each individual track (Tracks 1 & 2 and Subtracks 3 & 4).

This function can be carried out while the MT-100 is playing or when stopped.

To transpose all data (Tracks 1 & 2, Subtracks 3 & 4) simultaneously.

- (1) Press BEAT/MEAS button while keeping EXECUTE button pressed. EXECUTE LED begins to flash and the display indicates:

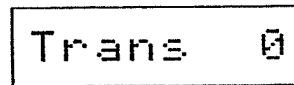

- (2) Rotate the Alpha-DIAL to change values. Rotate clockwise to transpose up, and counterclockwise to transpose down.

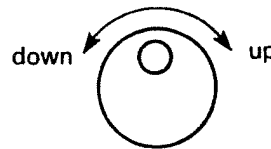

(Music data can be transposed up or down 24 steps.)

- (3) Press EXECUTE button to write the changed data in the MT-100.

Press STOP button to cancel the changed data and return the MT-100 to 'Stand By' mode.

To cancel any changed value while in the Transpose mode, press BEAT/MEAS button again.

To transpose any track individually:

- (1) Press BEAT/MEAS button while keeping EXECUTE button pressed. EXECUTE LED begins to flash and the display indicates:

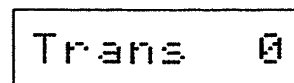

- (2) Press FWD button. The display will indicate:

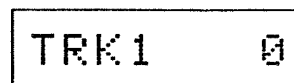

(Press BWD button to return to (1).)

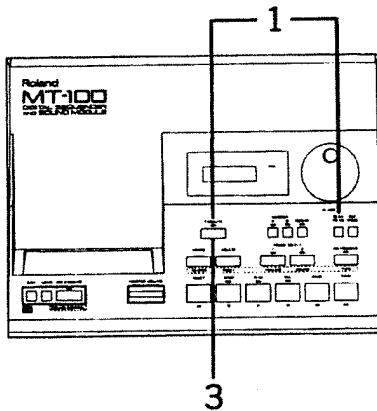

- (3) Rotate the Alpha-DIAL to change values. Rotate clockwise to transpose up, and counterclockwise to transpose down.

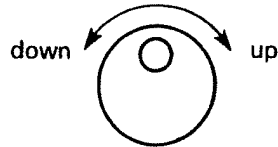

NOTE: Pressing FWD button once more will increase the Track number. When no music exists on a track, the track number does not appear and the display will indicate the next track which has data recorded there.

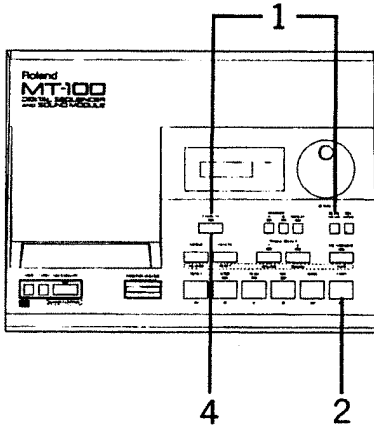

- (4) Press EXECUTE button to write the changed data in the MT-100.

- or -

Press STOP button to cancel the changed data and return the MT-100 to 'Stand-By' mode.

To cancel any changed value while in the Transpose mode, press BEAT/MEAS button again.

NOTE: Any data that has been transposed can be saved onto QD's in that mode.

b) Restore Original Tempo

If the tempo has been changed on playback of any data, the original tempo can be easily restored. This function can be carried out while the MT-100 is playing or when stopped.

- (1) Hold EXECUTE button down and rotate Alpha-DIAL either way. (Tempo is restored to original tempo.)

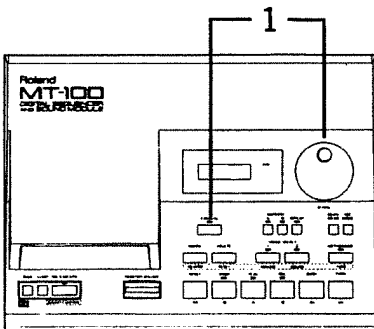
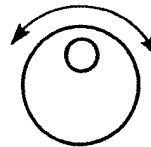

c) Subtracks (Track 3 & 4 and Rhythm)

Subtracks 3 & 4 and Rhythm track are mainly used to store prerecorded music data included on MT-100 pre-recorded Quick Disks (ISM Library). See "Prerecorded QD's". However, Sub tracks 3 & 4 can be used for customer recording with all the same functions as Track 1 & 2. See "Exchange Tracks and SAVE".

d) Mute Subtracks

Subtracks 3 & 4 and Rhythm Track can be muted (silenced) during playback.

To mute Subtrack 3 & 4:

- (1) Press EXECUTE button. If data has been recorded on Subtracks 3 & 4, the LEDs above TRACK SELECT 1 & 2 will light (The buttons and LEDs of TRACK 1 & 2 become momentarily functionable for Subtracks 3 & 4 respectively. Releasing the EXECUTE button returns the functioning of these to Tracks 1 & 2.)
- (2) To mute Subtrack 3, press TRACK SELECT 1 button while pressing EXECUTE button. LED will be turned off. To mute subtrack 4, press TRACK SELECT 2 button while pressing EXECUTE button.
- (3) To mute the Rhythm track (this only applies to Roland pre-recorded disk), press METRONOME button while pressing EXECUTE button.

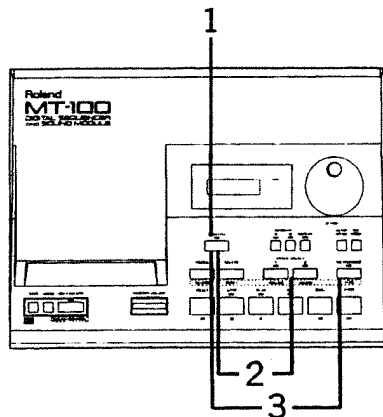

NOTE: If no music is recorded in Tracks 1 or 2, LEDs of TRACK SELECT buttons 1 or 2 will not be lit. If there is no recorded data in Tracks 3 or 4, on pressing EXECUTE button, LEDs of TRACK SELECT 1 or 2 buttons will not light. Similar, if there is no data recorded in the Rhythm track, on pressing EXECUTE button, METRONOME LED will not be lit.

If there is recorded data in Track 1 & 2, and no data is recorded in Subtracks 3 & 4, or in the Rhythm track, on pressing EXECUTE button, LEDs of TRACK SELECT 1 and 2 will remain lit, causing no change in LEDs.

Summary of "muting" procedure:

Track 1	= Press TRACK SELECT 1 button
Track 2	= Press TRACK SELECT 2 button
Subtrack 3	= Press EXECUTE & TRACK SELECT 1 button
Subtrack 4	= Press EXECUTE & TRACK SELECT 2 button
Rhythm	= Press EXECUTE & METRONOME button

e) Start playback with Automatic Metronome count-in.

- (1) While pressing EXECUTE button, press PLAY button. Playback will automatically start with a two-measure metronome count-in.

(This two-measure metronome count-in will occur even if the song is played from the very beginning - Measure 1)

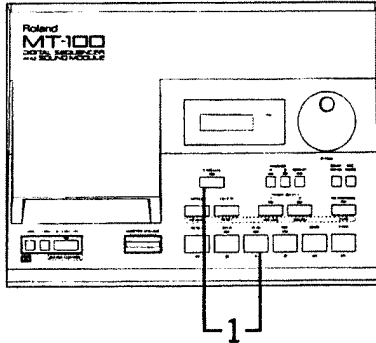

NOTE: If the playback is to be started from anywhere in the middle of a measure, the metronome will count-in one measure and up to the start of the playback in the next measure.

f) Start/Stop Playback with FOOT SWITCH

Instead of using the PLAY and STOP buttons, you may use the Foot Switch DP-2 (optional) for starting or stopping the playback. Connect the DP-2 Foot Switch into the START/STOP jack on the rear of the MT-100.

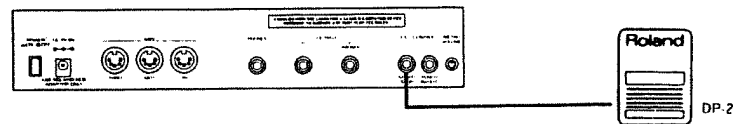

Press the Foot Switch to start, and press it again to stop.

Many more advanced functions are available with the MT-100. These are all explained in PART 2.

HOW TO USE MT-100 FEATURES - PART 2

5. EDIT

a) Delete

The Delete function will delete the measure presently appointed in the display and onwards to the end of the song.

- (1) Position the song at the measure number you wish to delete and onwards (by using FWD/BWD buttons.)
- (2) Press DELETE button. The display will indicate "Delete" and TRACK SELECT 1 & 2 LEDs will begin to flash.

Delete

- (3) Press TRACK SELECT button 1 or 2 to select which track you wish the deletion to take place. EXECUTE LED begins to flash.
- (4) Press EXECUTE button to execute the function. Measure presently appointed and onwards have now been deleted and the MT-100 is returned to the 'Stand-By' mode.

- or -

Press DELETE-button to return to (2).

- or -

Press STOP button to cancel the Delete function and return the MT-100 to 'Stand-By' mode.

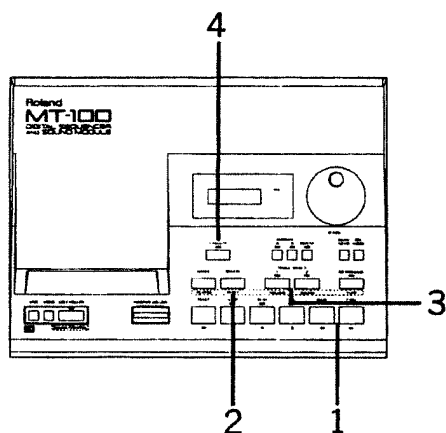

b) Merge

The Merge function allows you to combine the information (music data) on one track with the information on the other track to provide you with an empty track for additional recording. Separate MIDI channel information will be retained after the tracks have been merged.

Merge is similar to "bouncing" or "Ping-Ponging" tracks on a multi-track tape recorded. However, unlike a tape recorder, the sound quality is not affected by merging and an empty third track is not required.

When you are satisfied with the recordings in Tracks 1 & 2, you can merge both tracks into one:

- (1) Press MERGE button. The display will indicate "Merge" and TRACK SELECT 1 & 2 LEDs will begin to flash.

Merge

- (2) Press TRACK SELECT button 1 or 2 to select the destination track. EXECUTE LED begins to flash. (Remember any data on the destination track will be retained.)

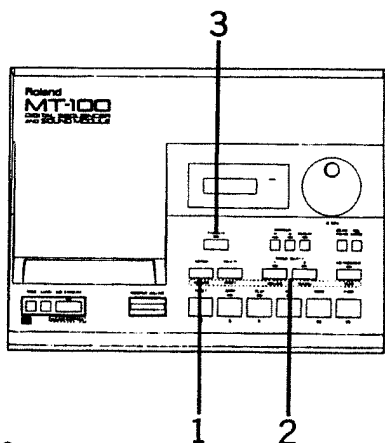

(3) Press EXECUTE button execute the function. The destination track selected now contains all information from both tracks. LED of source track (track merged from) will be turned off.

- or -

Press MERGE button to return to (2).

- or -

Press STOP button to cancel the Merge function and return the MT-100 to 'Stand-By' mode.

NOTE: After merging, the tracks cannot be separated.

c) PUNCH-IN/OUT RECORDING

The Punch-In/Out Recording function is useful for when you wish to re-record only a certain part of the recorded data. This can be valuable for correcting a part in real time without having to re-record the entire performance.

From the Punch-In position to the Punch-Out position, the MT-100 is in the recording mode, that is, the data previously recorded will be erased.

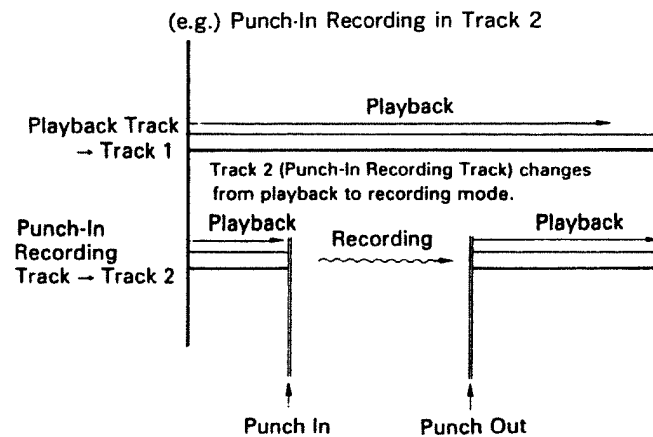

NOTE: Punch-In/Out Recording can be carried out from the beginning, ending or any position in a measure.

d) Punch-In/Out Recording - using MARKER A & B:

- (1) Press REC MODE button. The display will indicate "Real" and EXECUTE LED will begin to flash.

Real

- (2) Rotate Alpha-DIAL clockwise to select "PUNCH".

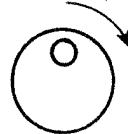

Punch

- (3) Press EXECUTE button to execute the change and return the MT-100 to 'Stand-By' mode.
(The MT-100 being switched off, any changed data is cancelled.)

- or -

Press STOP button to cancel the change of REC MODE and return the MT-100 to 'Stand-By' mode.

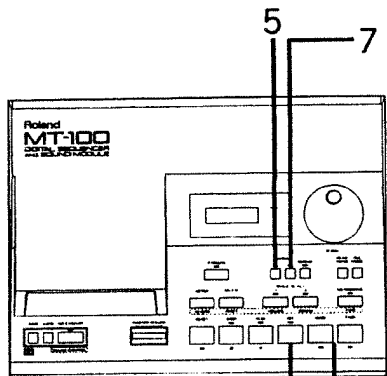
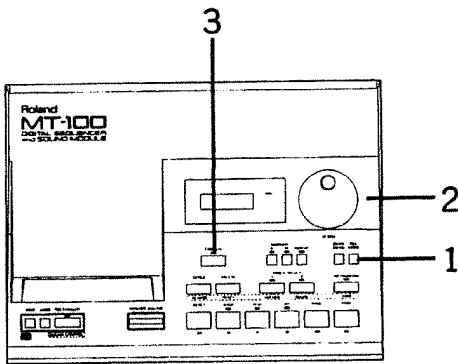

9
4.6.8

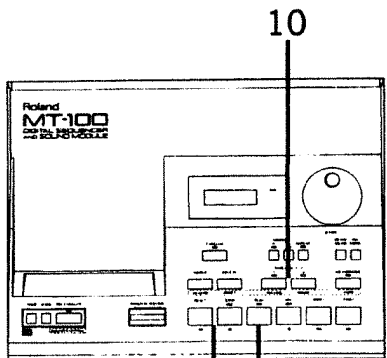

13 11

For cancellation of any changed value in the REC MODE, press REC MODE button.

- (4) Set the measure number where recording is to start (Punch-In).
- (5) Press MARKER A button. LED lights.
- (6) Set the measure number where recording is to end (Punch-Out).
- (7) Press MARKER B button. LED lights.
- (8) Set the measure number of the music to one or two measures before the point Punch-In recording is to be carried out.
- (9) Press REC button. REC LED will light and TRACK SELECT buttons 1 & 2 will begin to flash.
- (10) Press TRACK SELECT button 1 or 2, to put the MT-100 in REC 'Stand-By': TRACK SELECT LED of button pressed will stay lit and PLAY button LED will begin to flash.

*: * *: *: *

- (11) Press PLAY button to start playback.
(Count-In function is not available for this mode.)

- (12) Play MIDI keyboard at the point when Punch-In recording is required. (MT-100 will automatically start recording at MARKER A and stop recording at MARKER B.)



- (13) Press STOP button or RESET button to stop playback.

e) Punch-In/Out recording- using optional Foot Switch (DP-2):

Carry out procedures 1 to 3 in "Punch-In/Out Recording using marker A & B".

- (4) Connect the Foot Switch (DP-2) to the PUNCH IN/OUT jack located on the rear of the MT-100.

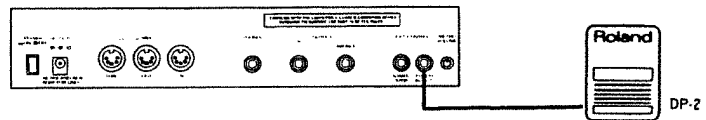

- (5) Press REC MODE button while keeping the STOP button pressed. The display will indicate "MARKER" and EXECUTE LED will begin to flash.

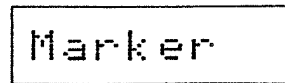

- (6) Rotate Alpha-DIAL counterclockwise to select "Pedal".

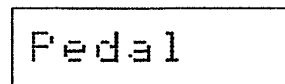
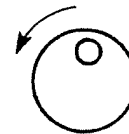

- (7) Press EXECUTE button to execute the change and return the MT-100 to 'Stand By' mode. (The MT-100 being switched off, any changed data is canceled.)

- or -

Press STOP button to cancel the change of Start mode and return the MT-100 to 'Stand-By' mode.

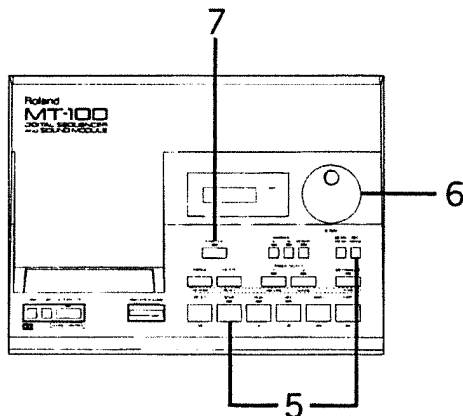

For cancellation of any changed value in the REC MODE, press REC MODE button.

- (8) Set the measure number of the music to one or two measures before the point Punch-In recording is to be carried out.
- (9) Press REC button. REC LED will light and TRACK SELECT buttons 1 & 2 will begin to flash.
- (10) Press TRACK SELECT button 1 or 2, to put MT-100 in REC 'Stand-By'. TRACK SELECT LED of button pressed will stay lit and PLAY button will begin to flash.
- (11) Press PLAY button to start playback. PLAY LED will light and REC LED will begin to flash.
(Count-In function is not available for this mode.)
- (12) Press the Foot Switch at the point when Punch-In recording is required and play MIDI keyboard. REC LED will stay lit.

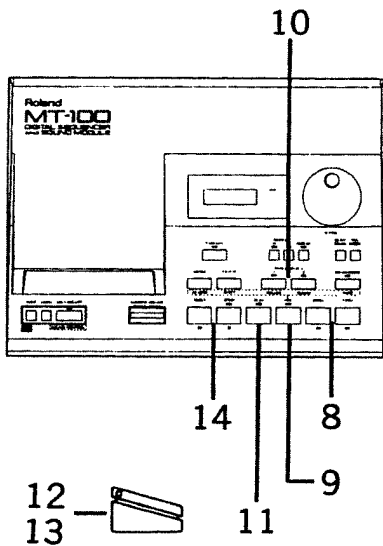

- (13) Press Foot Switch at the measure you wish the recording to stop (Punch-Out). REC LED will again start to flash.
- (14) Press STOP button or RESET button to stop playback.

NOTE: This Punch-In/Out feature is available for plural places.

NOTE: Both the above Punch-In/Out features can also be used to erase a certain note(s) from any track. Follow all procedures but do not play MIDI keyboard.

NOTE: The Punch-In/Out recording function should not be used to record or record over data which has been recorded with Pitch Bend or Hold effect on. Otherwise problems could occur, such as notes sounding continuously, and the overall pitch of the sound being altered.

f) Recording From the Middle or End of a Song

Data can be recorded from any measure in a track. When you enter data into an existing track, the new information will replace any data that previously existed in those measures.

You may also continue recording from the end of a song. The data in the preceding measures will remain. Recording from the end of the song gives you the option of remaining with the previous Time-Signature or selecting a new Time-signature.

NOTE: If the memory becomes full during recording, the display will respond with "Full". This means that no more notes can be recorded.

Full

Recording Non-Note information in Real Time

MIDI performance information other than notes may be overdubbed onto an empty track. This can be very useful for adding information such as Modulation, Sustain Pedal, Program Change, Volume etc. to a performance.

Parameters such as Program Changes and Volume should usually be entered as an overdub since it is difficult to enter this information while playing. In this way, you can listen to the performance and enter changes accordingly.

To record non-note information into a particular track, follow the procedure "OVERDUBBING" in PART 1. Instead of playing music on the keyboard, carry out the necessary non-note changes.

When you are satisfied with the additional performance information you have recorded, Merge (combine) it with the note information. When the merge operation has been carried out, the note and non-note data cannot be separated.

6. QUICK DISK (QD)

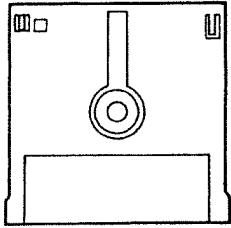

After recording your performance on the MT-100, the data can be stored onto a 2.8 inch Quick Disks (QD) using the built-in Disk Drive. The memory capacity is approx. 8,500 notes on each side.

Disk Drive Indicator

This is always lit when the Disk Drive is working.

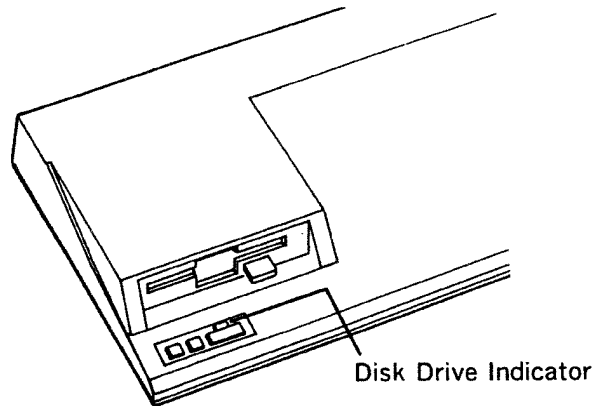

a) Quick Disk (QD) - LOAD

To load data from a Quick Disk, make sure that the Disk Drive indicator is not lit.

- (1) Insert a QD into the Disk Drive and press LOAD button. The display will ask "Load OK?" and QD-EXECUTE LED will begin to flash.

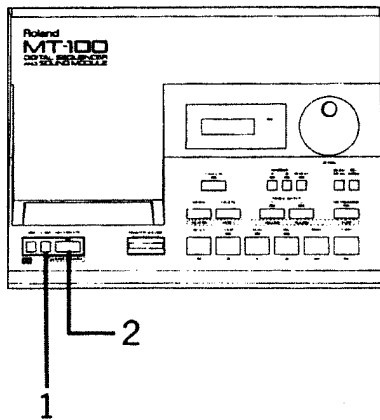

Load OK?

- (2) Press QD-EXECUTE button to execute the function.

When the loading is complete, a beep is heard and the MT-100 will return to the 'Stand-By' mode.

To remove the disk, push the EJECT button which is located at the right-hand side of the Disk Drive and take out the disk.

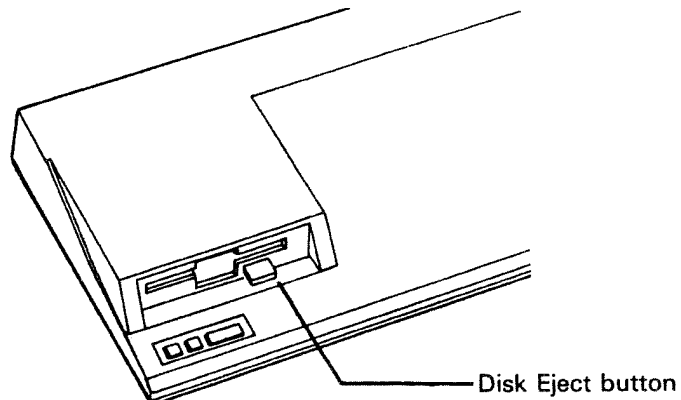

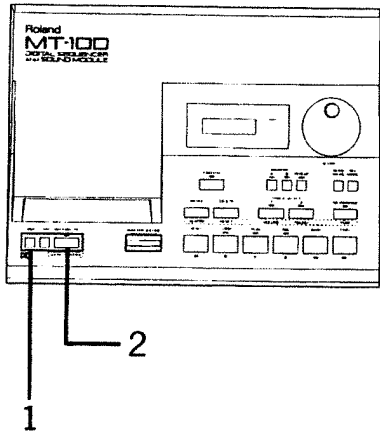

b) Quick Disk (QD) - SAVE

- (1) Insert a QD into the Disk Drive with the side indication (A or B) you wish to save on facing upwards and press SAVE button. The display will ask "Save OK?" and QD EXECUTE LED will begin to flash.

Save OK?

- (2) Press QD-EXECUTE button to execute the function.

When saving is completed, a beep is heard and the MT-100 returns to the 'Stand-By' mode.

(If the display responds with "Protect": The protect tab of the QD is broken off. To rewrite data on this QD, see page 10.)

To remove the disk, push the EJECT button which is located at the right-hand side of the Disk Drive and take out the disk.

The data saved on the QD can be loaded back into the MT-100 at any time.

You may be required to insert or change a QD by the MT-100 indicating the following messages in the LCD display:

- "INSERT QD": 1. When you pressed LOAD or SAVE button, the QD was not in the DISK Drive.
- "INSERT QD": 2. When you took the QD out of the Disk Drive to turn over for loading or saving the data from both sides of the disk.
- "CHANGE QD": Turn the QD over and insert again to load or save the data continuously from the first side of the disk.

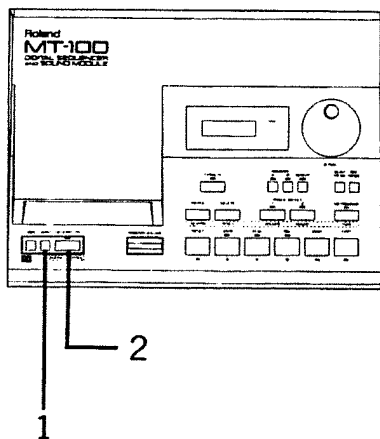

c) Playback Pre-recorded QD's

- (1) Insert the QD into the Disk Drive and press LOAD button. The display will ask "Load OK?" and QD EXECUTE LED will begin to flash.

Load OK?

- (2) Press QD-EXECUTE button to execute the function.

Try to playback the songs of the Pre-recorded QD (SAMPLE DISK). Two demonstration songs are stored on side A and two complete songs on side B. (See page 15.)

NOTE: ON side B playback, the MT-100 automatically stops at the end of the first song. The display on MT-100 will indicate measure 47. A PAUSE MARK is preset on this measure (See Page 53, 54. "ADVANCED OPTIONAL MODES" d to g). Press PLAY button again to start to playback the second song.

7. SOUND MODULE

How to control the sound module section.

The MT-100's sound module section consists of eight individual Synthesizer Parts and a Rhythm Part. The MIDI channel of each part is set as shown below.

Part Number	MIDI channel
1	2
2	3
3	4
4	5
5	6
6	7
7	8
8	9
Rhythm	10

Following is a list of Rhythm instrument voices contained in the MT-100 with, the note number assigned to each voice.

	(76)
(75) Claves	(74)
(73) Quijada	(72) Smba Whis L
	(71) Smba Whis S
(70) Maracas	(69) Cabasa
(68) Low Agogo	(67) High Agogo
(66) Low Timbale	(65) High Timbale
	(64) Low Conga
(63) High Conga	(62) Mt High Conga
(61) Low Bongo	(60) High Bongo
	(59)
(58)	(57)
(56) Cowbell	(55)
(54) Tambourine	(53)
	(52)
(51) Ride Cym	(50) Acou Hi Tom
(49) Crash Cym	(48) Acou Hi Tom
	(47) Acou Mid Tom
(46) Open Hi Hat 1	(45) Acou Mid Tom
(44) Open Hi Hat 2	(43) Acou Low Tom
(42) Clsd Hi Hat	(41) Acou Low Tom
	(40) Elec SD
(39) Hand Clap	(38) Acou SD
(37) Rim Shot	(36) Acou BD
	(35) Acou BD

The numbers in () are the Key numbers.

(Stereo balance)

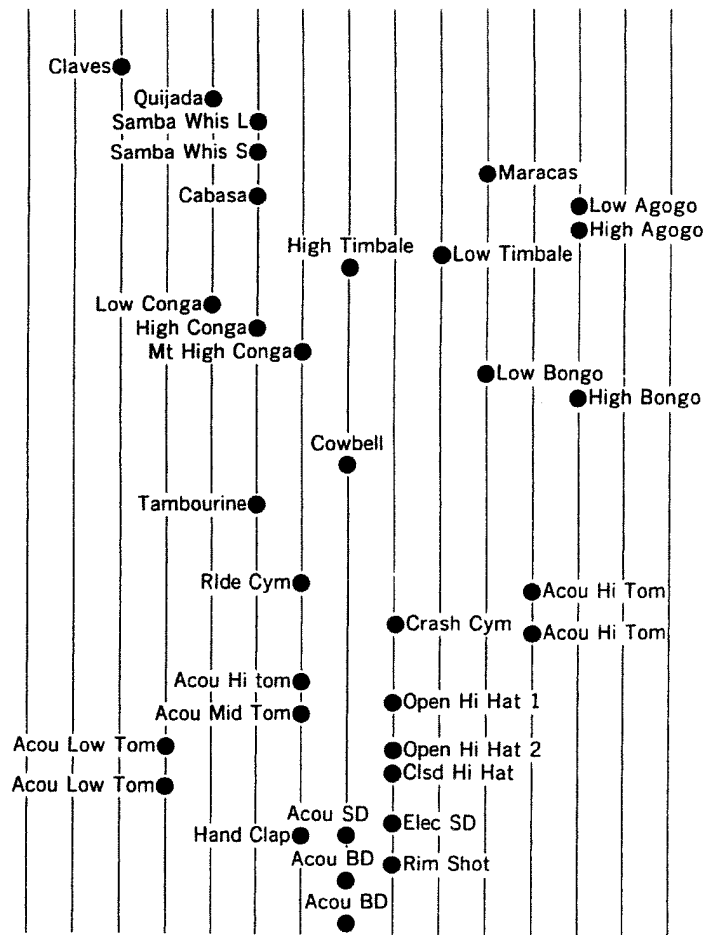

7> 6> 5> 4> 3> 2> 1> >> << 1< 2< 3< 4< 5< 6< 7<
LEFT CENTER RIGHT

SOUND-CONTROL button

When QD-EXECUTE indicator goes out, QD-EXECUTE button works SOUND CONTROL button. You can use functions shown by blue characters, while holding SOUND-CONTROL button down.

a) Sound Select

The MT-100 is equipped with an internal 128-timbre data library that lets you select sounds for any of the non-rhythm parts. This function is available while being both played and stopped.

- (1) Press SOUND (TRACK SELECT 2) button while keeping SOUND-CONTROL button pressed.

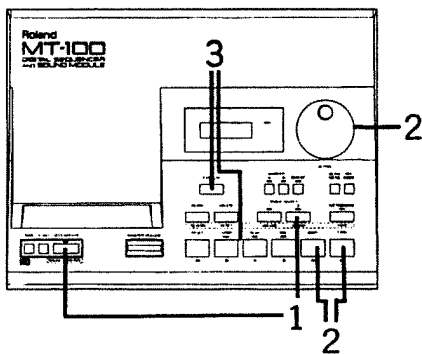

1 Bass 1

- (2) Rotate the Alpha-DIAL to change the sound.

1 Bass 2

To change parts: use FWD/BWD button

2 Piano1

- (3) Press EXECUTE button to write the data in the sound module of MT-100.

- or -

- (3) Press STOP button to cancel the changed data and return the MT-100 to 'Stand By' mode. (Press PLAY button to cancel and play.)

b) Volume for each part

This function allows independent volume control for each part, including the rhythm part.

This function is available while being both played and stopped.

- (1) Press VOLUME (TRACK SELECT 1) button while keeping SOUND-CONTROL button pressed.

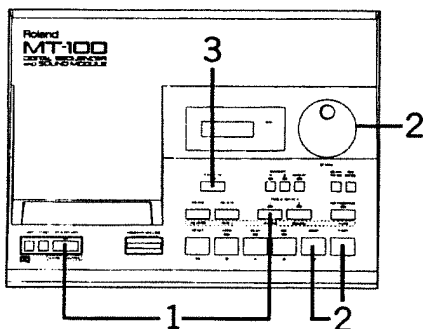

1 Vol 80

- (2) Rotate the Alpha-DIAL to change the part volume. Adjustable range: 0-100

1 Vol 42

To change parts: use FWD/BWD button

2 Vol 80

- (3) Press EXECUTE button to write the data in the sound module of MT-100.

- or -

- (3) Press STOP button to cancel the changed data and return MT-100 to 'Stand By' mode. (Press PLAY button to cancel and play.)

c) Reverb mode

Select the reverb mode as necessary for the overall output from the MT-100.

- (1) Press REVERB (MERGE) button while keeping SOUND-CONTROL button pressed.

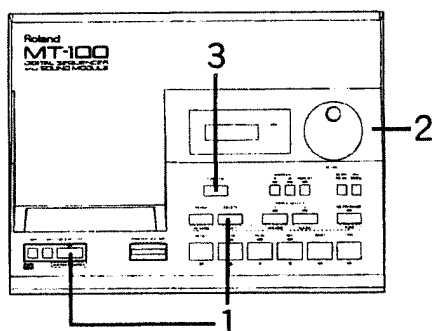

Reverb 5

- (2) Rotate the Alpha-DIAL to change the reverb mode. Adjustable range: 0-10

Reverb 1

- (3) Press EXECUTE button to write the data in the sound module of MT-100.

- or -

- (3) Press STOP button to cancel the changed data and return the MT-100 to 'Stand By' mode. (Press PLAY button to cancel and play.)

d) Master Tuning

This function adjusts the pitch of overall output from the MT-100. It is used to tune the MT-100 to the other instruments.

- (1) Press TUNE (METRONOME) button while keeping SOUND-CONTROL button pressed.

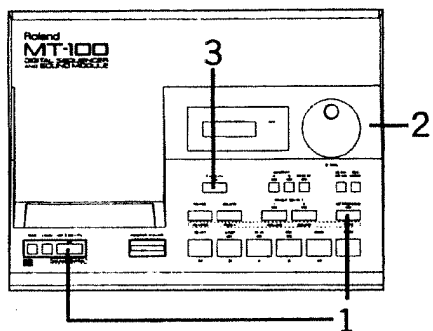

442.0 Hz

- (2) Rotate the Alpha-DIAL to change the master tuning. Adjustable range: 427.5 to 452.6 Hz

440.0 Hz

- (3) Press EXECUTE button to write the data in the sound module of MT-100.

- or -

- (3) Press STOP button to cancel the changed data and return the MT-100 to 'Stand By' mode. (Press PLAY button to cancel and play.)

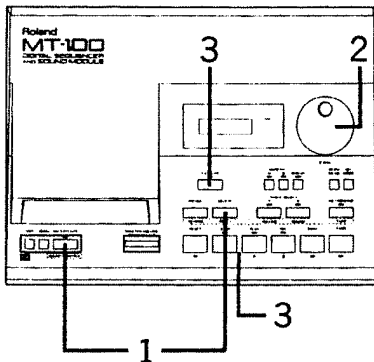

e) All Controllers Reset

This function resets all the controllers (sustain (damper), Pitch Bend, Expression Modulation) values. In other words this function resets all the controllers to the same condition as when the MT-100 was switched on (default values).

- (1) Press RESET (DELETE) button while keeping SOUND CONTROL (QD-EXECUTE) button pressed.
- (2) Rotate the Alpha-DIAL counterclockwise to select the controller reset mode.

CONTROLS

- (3) Press EXECUTE button to reset the control data.
- or -
- (3) Press STOP button to ignore reset function and return the MT-100 to 'Stand By' mode. (Press PLAY button to cancel and play.)

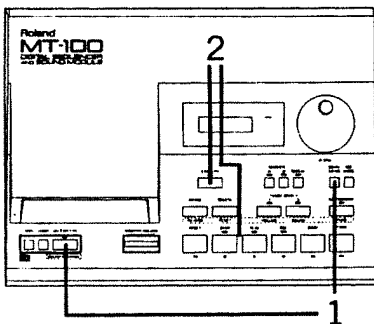

f) Sound data correction

The system exclusive message causes different conditions between the display and the sound module section. This function corrects the current condition to the display.

- (1) Press BEAT/MEAS button while keeping SOUND CONTROL button pressed.

DATA SET

- (2) Press EXECUTE button to correct the sound data.
- or -
- (2) Press STOP button to ignore the correct function and return the MT-100 to 'Stand By' mode. (Press PLAY button to cancel and play.)

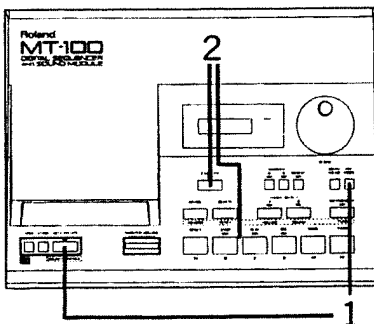

g) Write Sound Setup into the sequencer data

This function writes the data of sound setup into sequence data on the bar, and automatically activates SOUND DATA CORRECTION

- (1) Press REC MODE button while keeping SOUND CONTROL button pressed.

DATA WRT

- (2) Press EXECUTE button to write data.
- or -
- (2) Press STOP button to ignore the write function and return the MT-100 to 'Stand By' mode. (Press PLAY button to cancel and play.)

h) Clear Sound Setup in the sequencer data

This function clears the data of sound set up in the sequence data.

- (1) Press REC MODE button while keeping SOUND-CONTROL button pressed.

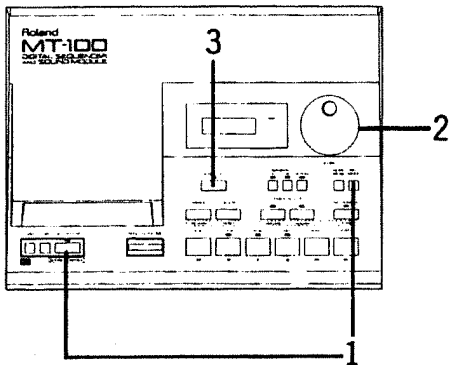

DATA WRT

- (2) Rotate Alpha-DIAL clockwise to select "DATA CLR".
 - (3) Press EXECUTE button to clear data.
- or -
- (3) Press STOP button to ignore the clear function and return the MT-100 to 'Stand By' mode. (Press PLAY button to cancel and play.)

i) Partial and Maximum Voices

The MT-100 can produce a maximum of 32 voices using 32 Partials at the same time. A Partial is the smallest unit of sound within the MT-100.

A tone consists of one to four Partials. A Tone made of only one Partial can be played 32 voice polyphonically, but a Tone of two Partials has 16 voices, and a Tone of four Partials is 8 voice polyphonic.

It is very important that you fully understand this concept. Specially in the Multi Timbral mode, this can be very tricky as several Tones are involved at the same time.

j) All Tones, Parameters and Controllers Reset

All the tone, Volume, Reverb parameters and controllers are returned to the same conditions as when the MT-100 was switched on (default values).

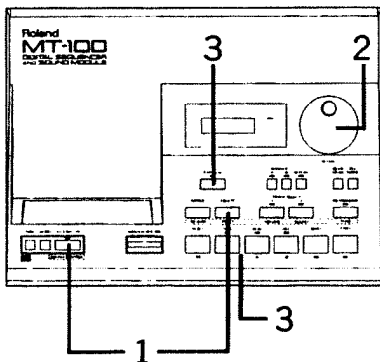

COMPLETE

- (1) Press RESET (DELETE) button while keeping SOUND CONTROL (QD-EXECUTE) button pressed.
 - (2) Rotate the Alpha-DIAL clockwise to select the All Reset mode.
- or -
- (3) Press EXECUTE button to reset all parameters and the controllers.
- or -
- (3) Press STOP button to ignore reset function and return the MT-100 to 'Stand By' mode. (Press PLAY button to cancel and play.)

8 MIDI CONFIGURATION MEMORY

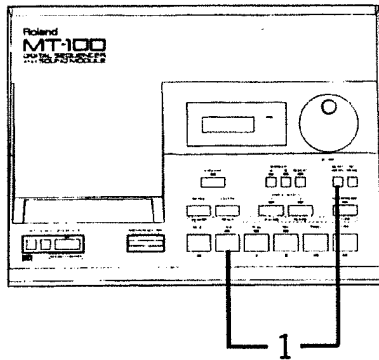

Through the use of the following eight parameters, you can select which information the MT-100 sends or receives :

- (1) Press BEAT/MEAS button while keeping STOP button pressed. The display will indicate the first parameter and its value "THRU ON" and the EXECUTE LED will begin to flash.

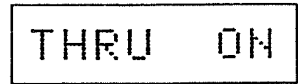

a) SOFT THRU

The SOFT THRU function on the MT-100 combines the signal coming into the MIDI Input with the signal transmitted from the MIDI Output.

When using a MIDI master keyboard, example: Roland Contemporary Piano (HP); this function must be in the ON position to play the connected sound module. If Soft Thru is OFF, the master keyboard's live performance will not pass through the MIDI out of the MT-100 to the sound module.

- (2) Rotate the Alpha-DIAL to change value (ON or OFF).

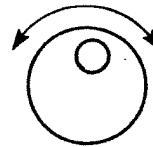

- (3a) Press EXECUTE button while keeping REC button pressed, to write the change of MIDI CONFIGURATION MEMORY in the MT-100 and return the MT-100 to 'Stand-By' mode. (The changed value is stored even if the MT-100 is switched off.)

- or -

- (3b) Press EXECUTE button to store the change value of MIDI CONFIGURATION MEMORY in the MT-100 temporarily and return the MT-100 to 'Stand-By' mode. (The MT-100 being switched off, any changed value is canceled.)

- or -

- (3c) Press STOP button to cancel the change of MIDI CONFIGURATION MEMORY and return the MT-100 to 'Stand-By' mode.

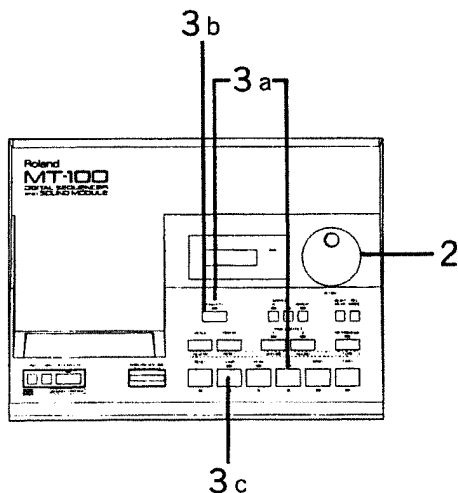

For cancellation of any changed value in the selected mode, press BEAT/MEAS button.



NOTE: When using a normal synthesizer without a MIDI Local ON/OFF switch, switch off the SOFT THRU parameter, otherwise it could cause a problem.

To change other MIDI parameters, carry out procedure (1) then:
Press FWD button once to select the second parameter and the display will indicate its value "SYNC INT".

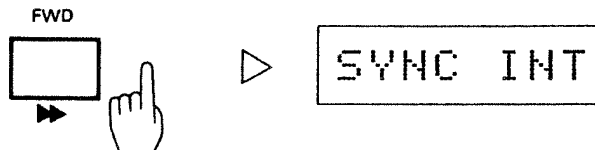

b) SYNC MODE

The SYNC MODE function determines the mode of the clock control of the MT-100. (Internal or External) The MT-100 can function as either a master clock which will control other MIDI instruments (such as an external drum machine), or as a slave which will sync to the clock of another MIDI instrument or device.

When using an external drum machine or device, set the SYNC MODE parameter to internal (SYNC INT).

To use an external device as the master and the MT-100 as the slave:

- (2) Rotate the Alpha-DIAL clockwise to change the mode to "SYNC EXT".

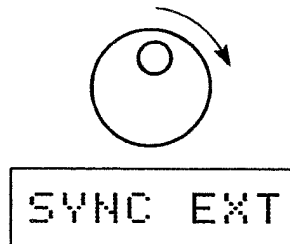

Follow procedures (3a), (3b) and (3c) to execute or cancel any change:

Press FWD button twice to select the third parameter and the display will indicate its value "CLK OFF".

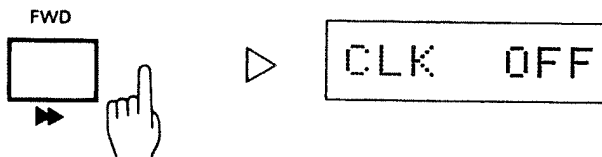

c) MIDI Clock

The MIDI timing (clock) information is in the off position upon turn-on of the MT-100. If you wish to transmit this information:

- (2) Rotate the Alpha-DIAL clockwise to change the value to "CLK ON".

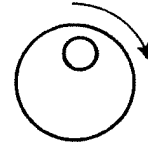

CLK ON

Follow procedures (3a), (3b) and (3c) to execute or cancel any change:

Press FWD button three times to select the fourth parameter and the display will indicate its value "AFT ON".

FWD



AFT ON

d) After-Touch

After-touch is MIDI information which is produced by applying pressure to the key after it has been played. Channel monophonic after-touch, found on most synthesizers and keyboard controllers sends out one stream of after-touch information for the entire keyboard. Channel (monophonic) after-touch uses less memory in the MT-100 than polyphonic after-touch but if you using a keyboard with Channel (monophonic) after-touch, you may still wish to filter out this information while recording to conserve memory.

- (2) Rotate the Alpha-DIAL counterclockwise to change the value to "AFT OFF".

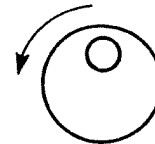

AFT OFF

Follow procedures (3a), (3b) and (3c) to execute or cancel any change:

Press the FWD button four times to select the fifth parameter and the display will indicate its value "BEND ON".

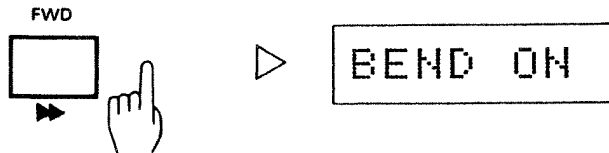

e) Pitch Bend

Pitch Bend is a continuous change in frequency (pitch) and is generated from Pitch Bend levers, wheels or ribbons. Pitch Bending uses a large amount of memory. To conserve memory, you may wish to filter out this information while recording.

(2) Rotate the Alpha-DIAL counterclockwise to change the value to "BEND OFF"

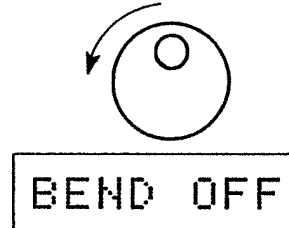

Follow procedures (3a), (3b) and (3c) to execute or cancel any change:

Press FWD button five times to select the sixth parameter and the display will indicate its value "CTRLON".

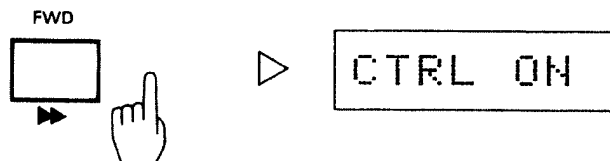

f) Control Change

The Control Change message is used to modify the MIDI data with a controller other than a keyboard. These include - Damper (Sustain) Pedal, Soft pedal, Modulation wheel or lever, Breath Controller etc. If using a keyboard which includes one of these controllers, you may wish to filter out this information when recording:

- (2) Rotate the Alpha-DIAL counterclockwise to change the value to "CTRL OFF"

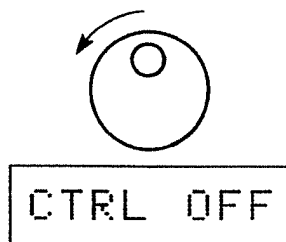

Follow procedures (3a), (3b) and (3c) to execute or cancel any change:

Press FWD button six times to select the seventh parameter and the display will indicate its value "PROG ON".

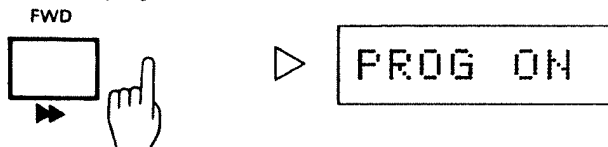

g) Program Change

Program Change messages can be sent through MIDI to change a sound module's patch (program) numbers. Program Change messages sent from a keyboard controller to the MT-100 can be selectively filtered out by turning off the Receive Program Change.

- (2) Rotate the Alpha-DIAL counterclockwise to change the value to "PROG OFF".

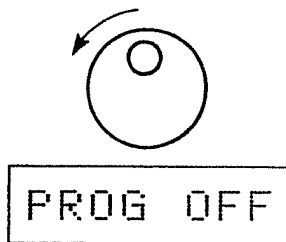

Follow procedures (3a), (3b) and (3c) to execute or cancel any change:

Press FWD button seven times to select the eighth parameter and the display will indicate its value "EXCL ON".

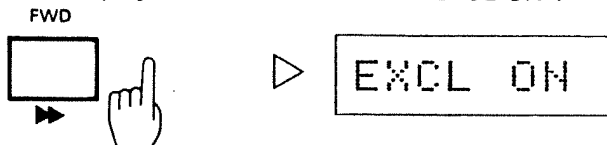

h) System Exclusive

System Exclusive messages contains parameter information that is specific to a particular product or device. The MT-100 has the ability to record this information from instruments that can send it. Because System Exclusive can use a large amount of memory, you may wish to filter out System Exclusive information while you are recording.

(2) Rotate the Alpha-DIAL counterclockwise to change the value "EXCL OFF"

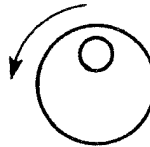

EXCL OFF

Follow procedures (3a), (3b) and (3c) to execute or cancel any change:

NOTE: If your master keyboard does not send any of the MIDI messages (After-touch, Pitch Bend, Control Change, Program Change, System Exclusive), there is no need to turn any of these parameters OFF.

Summary of MIDI CONFIGURATION MEMORY parameters and turn-on (default) values.

"THRU ON"	(default)	SOFT THRU
"SYNC INT"	(default)	SYNC MODE
"CLK OFF"	(default)	Transmit MIDI clock
"AFT ON"	(default)	Receive aftertouch (Channel/keys)
"BEND ON"	(default)	Receive Pitch Bend
"CTRL ON"	(default)	Receive Control Change
"PROG ON"	(default)	Receive Program Change
"EXCL ON"	(default)	Receive System Exclusive

To change parameters: use FWD/BWD button



To change values: use Alpha-DIAL

For "ON" or "EXT", rotate Alpha-DIAL clockwise and for "OFF" or "INT", counterclockwise.

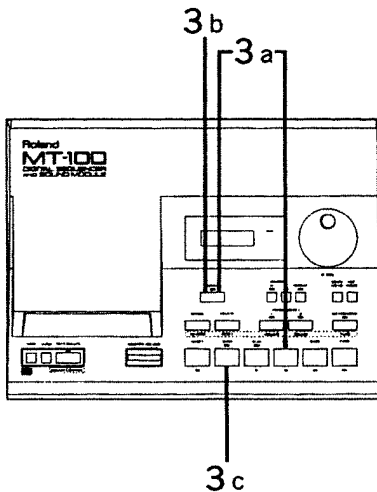
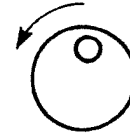
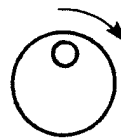

(3a) Press EXECUTE button while keeping REC button pressed, to write the change of MIDI CONFIGURATION MEMORY in the MT-100 and return the MT-100 to 'Stand-By' mode. (The changed value is stored even if the MT-100 is switched off.)

- or -

(3b) Press EXECUTE button to store the changed value of MIDI CONFIGURATION MEMORY in the MT-100 temporarily and return the MT-100 to 'Stand-By' mode. (The MT-100 being switched off, any changed value is cancelled.)

- or -

(3c) Press STOP button to cancel the change of MIDI CONFIGURATION MEMORY and return the MT-100 to 'Stand-By' mode.

For cancellation of any changed value in the selected mode, press BEAT/MEAS button.



9. ERROR MESSAGES

Error 1	- MAIN MEMORY error
Error 2	- MIDI CONFIGURATION MEMORY error
	▲ The MT-100 has broken down. Please call your local Roland service station.
Full	- Overloading the memory capacity in recording.
Load ERR	- The QD is totally blank. - The QD was once used and loaded on other Roland products. - The QD was once used and loaded on other manufacturer's products. - Totally impossible for the disk drive to read because of the QD being damaged or faulty.
Save ERR	- Accurate saving is not possible.
Protect	- The protect tab of the QD is broken off.
VerifyERR	- data in MT-100 does not correspond to data on QD when QD-Verify feature has been executed.
Cannot !	- Impossible to save data onto the QD because of protection.
Ejected!	- QD is ejected, while loading or saving.
Mismatch	- In loading the data saved on both sides of a QD, and when the same side of the QD is inserted again or different QD is inserted.
CheckERR	- The QD is totally blank. - The QD was once used and loaded on other Roland products. - The QD was once used and loaded on other manufacturer's products.

▲ Pressing the Stop Button will return the unit to the previous condition (before the Error Messages was displayed).

10. ADVANCED OPTIONAL MODES

a) QUANTIZE

The MT-100 also includes a special feature called "Quantize". When you record a performance into the MT-100 via MIDI, it is possible for the MT-100 to actually "correct" small timing errors. This is done by arithmetically dividing each measure into small quantities of time, and hence is called "quantizing" the measure. For example, a measure may be divided into 16th notes, so that if you play 16th notes not in correct timing, the result will be exact 16th notes. Obviously, this will make some performances recording much easier. If you need to record a drum part in strict timing from the keyboard, or you simply wish to record a part that is either too fast or too difficult, then "Quantize" can provide some spectacular results.

Furthermore, the "Quantize" featured in the MT-100 is unique, in that it happens automatically. However, you will need to turn it ON. Then, every time you record a specific part, the MT-100 will immediately begin to correct it, the moment you press the STOP button. To turn on the Quantize function, simply follow the procedure below:

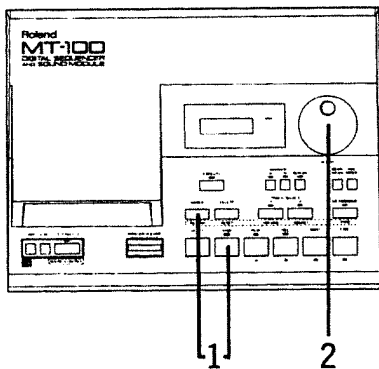

IF YOU WISH TO RECORD WITH QUANTIZE

1. While holding down the STOP button, press the MERGE button. The display will show "Qua = OFF", and the EXECUTE light will begin to flash.

Qua = OFF

2. Rotate the Alpha-DIAL to select the Quantize resolution, that is, the size of the smallest "quantity" of note you are going to record. There are five possibilities as shown below:

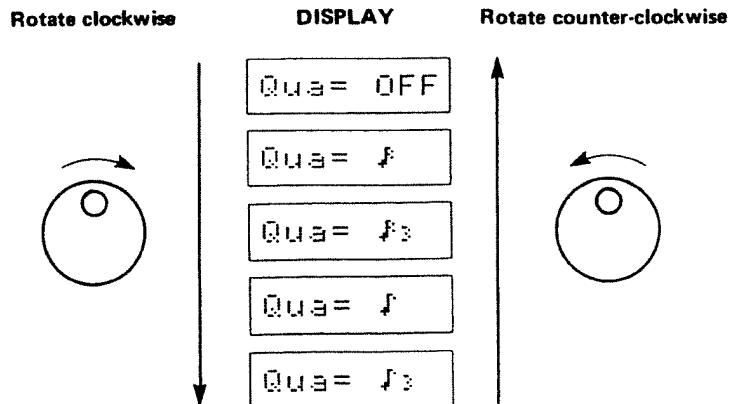

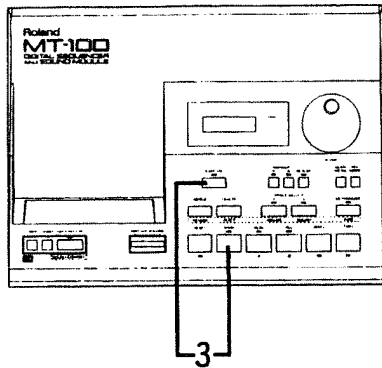

3. Press the EXECUTE button to confirm this choice and return the MT-100 to the "Stand-By" mode.

- or -

Press the STOP button to cancel any change and return to the MT-100 to the "Stand-By" mode.

4. Record the performance. When you have finished recording, press the STOP button. The display will briefly indicate "Quantize", and then return MT-100 to the "Stand-By" mode.

NOTE: Whenever the MT-100 is turned off, it returns to the Quantize = OFF position. Consequently, you will always need to turn this function on after turning on the MT-100, if you need the Quantize feature.

NOTE: The Quantize function can correct small timing errors, but it cannot repair serious mistakes. However, once a part has been Quantized, it is a simple matter to return to particular sections that were impossible to Quantize accurately, and then use the Punch-In/Out function described on page 31 of this manual.

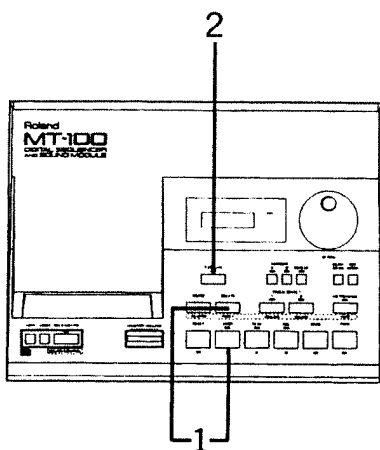

b) All Clear - to clear memory and mode changes completely.

- (1) Press DELETE button while keeping STOP button depressed. The display will indicate "All Clear" and EXECUTE LED starts to flash.

AllClear

- (2) Press EXECUTE button to execute the function and clear all data.

All the tracks become empty and all the data of REC MODE, Punch-In/Out start, BEAT/MEAS, MIDI CONFIGURATION MEMORY are returned to the same conditions as when MT-100 was switched on (default value).

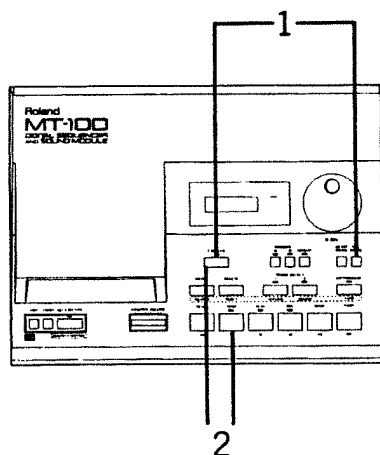

c) Memory Consumption

The MT-100 will display by percentage how much memory has been used on any recording.

- (1) Press REC MODE button while keeping EXECUTE button pressed. The display will indicate the amount of memory already consumed.

Used***%

- (2) Press STOP button or EXECUTE button to return the MT-100 to 'Stand-By' mode.

d) PAUSE MARK

PAUSE MARKS are similar to marks set by MARKER A & B buttons but are invisible to the eye. PAUSE MARKS can be set by the player or factory set (Pre-recorded QD's).

When a PAUSE MARK is set, the music will stop at that point. To start the MT-100 again press PLAY.

PAUSE MARKS can be used to:

- 1) divide one short song from another on the same recording.
- 2) pause the playback of a song while a piece of music is played manually on the master keyboard (Cadenza, Rubato, obbligato section).
- 3) pause the playback of a tune in between different movements.
- 4) pause between exercises in educational music pre-recorded by teachers.

e) PAUSE MARK Set

To set a pause mark in a particular Song:

- (1) Position the song at the measure you wish to set the PAUSE MARK using FWD or BWD buttons.
- (2) Press REC button while keeping both STOP button and QD-EXECUTE button pressed. (A PAUSE MARK will be set).

(A PAUSE MARK can be set only at the beginning of the measure.)

A maximum of twenty PAUSE MARKS can be set within the same song.

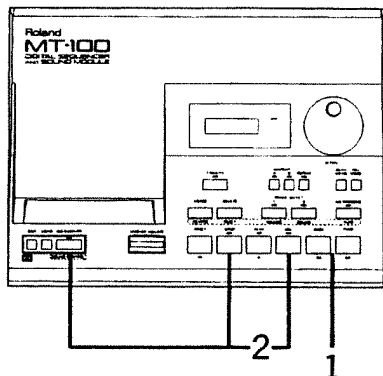

f) PAUSE MARK Delete

A PAUSE MARK which has been previously set can be cancelled:

- (1) By using BWD/FWD buttons go to the beginning of the measure which includes the PAUSE MARK you wish to cancel.
- (2) Press RESET button while keeping both the STOP button and QD-EXECUTE button pressed. (The PAUSE MARK will be canceled).

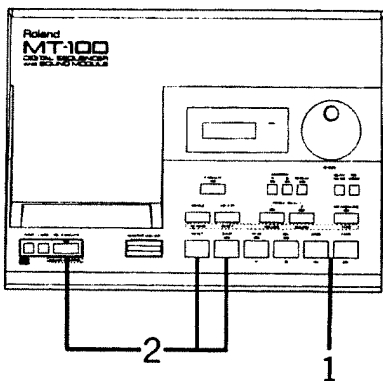

g) Jump PAUSE MARK

To jump to a particular PAUSE MARK forward or backward:

- (1) Press FWD or BWD button while keeping STOP button depressed.

(The MT-100 will jump to the nearest PAUSE MARK. In case of no PAUSE MARK being set, the MT-100 will jump to the beginning or end of the song.)

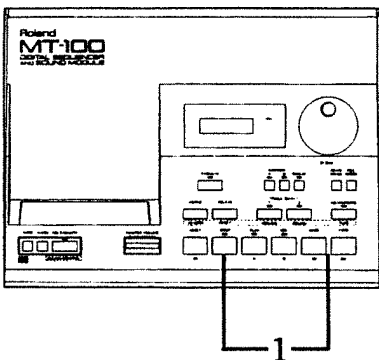

a) QD-Model check

By inserting a QD into the Disk Drive, it is possible to check whether the QD has data saved on it and what instrument was used to store the data.

- (1) Press LOAD button while keeping STOP button depressed. The display will indicate "Check QD" and the QD-EXECUTE LED will begin to flash.

Check QD

- (2) Press QD-EXECUTE button. The display will indicate "Checking" and change to show the format of the QD inserted:

Checking

Example: If the data on the QD was stored from MT-100, the display will indicate "MC-03".

If the Roland S-10 sampler keyboard was used to store the data, the display will indicate "S-10".

MC-03

S-10

In case of QD's that have been used on other manufacturer's products to store data, "CheckERR" is indicated in the display.

CheckERR

- (3) Press STOP button to return to 'Stand-By' mode.

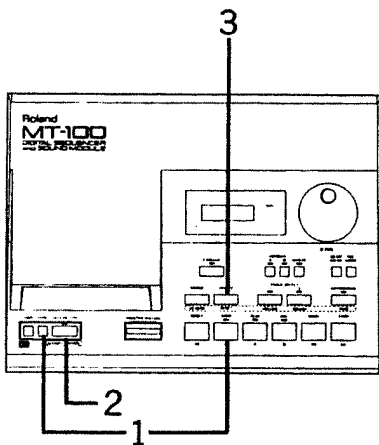

b) QD-Verify

After loading or saving QD's, the data in the MT-100 can be checked against that on the QD:

- (1) Press SAVE button while keeping STOP button pressed. The display will indicate "VerifyQD" and the QD-EXECUTE LED will begin to flash.

VerifyQD

- (2) Press QD-EXECUTE button. The display will indicate "Verify.." and change to : "Complete" when the data in the MT-100 corresponds to the data on the QD.

Verify..

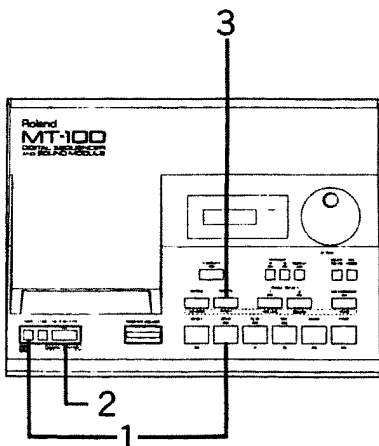

Complete

- (3) Press STOP button to return the MT-100 to 'Stand-By' mode.

If the data in the MT-100 does not correspond to that on the QD, the display will indicate "VerifyEr".

VerifyEr

c) Exchange Tracks and SAVE

Although from the panel there are only two visible Tracks, TRACK SELECT button 1 & 2, the MT-100 has a total of five Tracks, Two main TRACKS (1&2), two Sub Tracks (3 & 4) and a Rhythm Track.

The two main tracks is where you will record your own performance. The two Sub Tracks are used mainly for the purpose of storing pre-recorded Quick Disks but can be exchanged with Tracks 1 & 2 to store extra possibilities on recording. The Rhythm track is solely used to store pre-recorded rhythm data which can be temporarily muted but cannot be changed in any way.

To exchange Sub Tracks 3 & 4 with Tracks 1 & 2:

- (1) Press SAVE button while keeping EXECUTE button pressed. The display will ask "Ex&Save?" and QD-EXECUTE LED will begin to flash.

Ex&Save?

- (2) Press QD-EXECUTE button. The display will indicate "ExSaving".

ExSaving

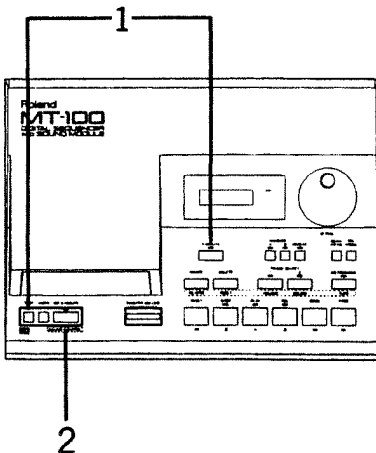

When the PR-100 has finished saving (disk indicator light is turned off), re-load QD into MT-100.

Tracks 1 & 2 will now become Sub Tracks 3 & 4, and Sub Tracks 3 & 4 will now become Tracks 1 & 2 and will have all the functional capabilities as explained in this manual.

SPECIFICATIONS

MT-100 : Digital Sequencer with a built-in Multi Timbral Sound Module

Sequencer Section

Memory Capacity : approx. 17,000 notes (Song Data)

Disk Drive : 2.8 inch Quick Disk (QD)

Sound Module Section

LA System

Maximum Voices : 32 Voices

Preset Tones : 128 tones

30 rhythm tones

Rear Panel

Start/Stop Jack (DP-2)

Punch In/Out Jack (DP-2)

MIDI Connectors (IN, OUT, THRU)

Output Jacks : L (mono) and R

Headphones Jack

DC IN Jack

Display

8 figure Liquid Crystal Display

Power Supply

9V DC (When using supplied AC Adapter)

Consumption

950mA/9V

Dimensions

12" × 8⁷/₈" × 3¹/₁₆"

305(W) × 225(D) × 78.6(H) mm

(except for the protruding sections)

Weight

5 lb 11 oz

2.6 kg

Accessories

Owner's Manual

MT-100 OPERATION GUIDE

Sound List

Quick Operation Table

Guide Book for MIDI

Sample Disk (QD)

Connection Cable (2 pcs.)

MIDI Cable (2 pcs.)

* Specifications are subject to change without notice.

Roland Exclusive Messages

1. Data Format for Exclusive Messages

Roland's MIDI implementation uses the following data format for all exclusive messages (type IV):

Byte	Description
F0H	Exclusive status
41H	Manufacturer ID (Roland)
DEV	Device ID
MDL	Model ID
CMD	Command ID
[BODY]	Main data
F7H	End of exclusive

MIDI status : F0H, F7H

An exclusive message must be flanked by a pair of status codes, starting with a Manufacturer-ID immediately after F0H (MIDI version 1.0).

Manufacturer-ID : 41H

The Manufacturer-ID identifies the manufacturer of a MIDI instrument that triggers an exclusive message. Value 41H represents Roland's Manufacturer-ID.

Device-ID : DEV

The Device-ID contains a unique value that identifies the individual device in the multiple implementation of MIDI instruments. It is usually set to 00H - 0FH, a value smaller by one than that of a basic channel, but value 00H - 1FH may be used for a device with multiple basic channels.

Model-ID : MDL

The Model-ID contains a value that uniquely identifies one model from another. Different models, however, may share an identical Model-ID if they handle similar data.

The Model-ID format may contain 00H in one or more places to provide an extended data field. The following are examples of valid Model-IDs, each representing a unique model:

01H
02H
03H
00H, 01H
00H, 02H
00H, 00H, 01H

Command-ID : CMD

The Command-ID indicates the function of an exclusive message. The Command-ID format may contain 00H in one or more places to provide an extended data field. The following are examples of valid Command-IDs, each representing a unique function:

01H
02H
03H
00H, 01H
00H, 02H
00H, 00H, 01H

Main data : BODY

This field contains a message to be exchanged across an interface. The exact data size and contents will vary with the Model-ID and Command-ID.

2. Address-mapped Data Transfer

Address mapping is a technique for transferring messages conforming to the data format given in Section 1. It assigns a series of memory-resident records -- waveform and tone data, switch status, and parameters, for example -- to specific locations in a machine-dependent address space, thereby allowing access to data residing at the address a message specifies.

Address-mapped data transfer is therefore independent of models and data categories. This technique allows use of two different transfer procedures: one-way transfer and handshake transfer.

One way transfer procedure (See Section 3 for details.)

This procedure is suited for the transfer of a small amount of data. It sends out an exclusive message completely independent of a receiving device status.

Connection Diagram



Connectional point 2 is essential for "Request data" procedures. (See Section 3.)

Handshake-transfer procedure (See Section 4 for details.)

This procedure initiates a predetermined transfer sequence (handshaking) across the interface before data transfer takes place. Handshaking ensures that reliability and transfer speed are high enough to handle a large amount of data.

Connection Diagram

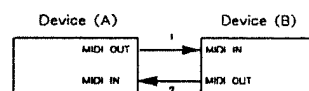

Connectional points 1 and 2 is essential.

Notes on the above two procedures

- * There are separate Command-IDs for different transfer procedures.
- * Devices A and B cannot exchange data unless they use the same transfer procedure, share identical Device-ID and Model ID, and are ready for communication.

3. One-way Transfer Procedure

This procedure sends out data all the way until it stops when the messages are so short that answerbacks need not be checked.

For long messages, however, the receiving device must acquire each message in time with the transfer sequence, which inserts intervals of at least 20 milliseconds in between.

Types of Messages

Message	Command ID
Request data 1	RQ1 (11H)
Data set 1	DT1 (12H)

Request data # 1 : RQ1 (11H)

This message is sent out when there is a need to acquire data from a device at the other end of the interface. It contains data for the address and size that specify designation and length, respectively, of data required.

On receiving an RQ1 message, the remote device checks its memory for the data address and size that satisfy the request.

If it finds them and is ready for communication, the device will transmit a "Data set 1 (DT1)" message, which contains the requested data. Otherwise, the device will send out nothing.

Byte	Description
F0H	Exclusive status
41H	Manufacturer ID (Roland)
DEV	Device ID
MDL	Model ID
11H	Command ID
aaH	Address MSB
⋮	⋮
	LSB
ssH	Size MSB
⋮	⋮
	LSB
sum	Check sum
F7H	End of exclusive

- *The size of the requested data does not indicate the number of bytes that will make up a DT1 message, but represents the address fields where the requested data resides.
- *Some models are subject to limitations in data format used for a single transaction. Requested data, for example, may have a limit in length or must be divided into predetermined address fields before it is exchanged across the interface.
- *The same number of bytes comprises address and size data, which, however, vary with the Model-ID.
- *The error checking process uses a checksum that provides a bit pattern where the least significant 7 bits are zero when values for an address, size, and that checksum are summed.

Data set 1 : DT1 (12H)

This message corresponds to the actual data transfer process. Because every byte in the data is assigned a unique address, a DT1 message can convey the starting address of one or more data as well as a series of data formatted in an address-dependent order.

The MIDI standards inhibit non-real time messages from interrupting an exclusive one. This fact is inconvenient for the devices that support a "soft-through" mechanism. To maintain compatibility with such devices, Roland has limited the DT1 to 256 bytes so that an excessively long message is sent out in separate segments.

Byte	Description
F0H	Exclusive
41H	Manufacturer ID (Roland)
DEV	Device ID
MDL	Model ID
12H	Command ID
aaH	Address MSB
⋮	⋮
	LSB
ddH	Data
⋮	⋮
sum	Check sum
F7H	End of exclusive

- *A DT1 message is capable of providing only the valid data among those specified by an RQ1 message.
- *Some models are subject to limitations in data format used for a single transaction. Requested data, for example, may have a limit in length or must be divided into predetermined address fields before it is exchanged across the interface.
- *The number of bytes comprising address data varies from one Model-ID to another.
- *The error checking process uses a checksum that provides a bit pattern where the least significant 7 bits are zero when values for an address, size, and that checksum are summed.

Example of Message Transactions

- Device A sending data to Device B
Transfer of a DT1 message is all that takes place.

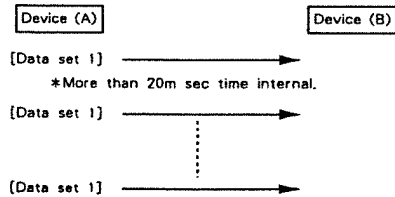

- Device B requesting data from Device A
Device B sends an RQ1 message to Device A. Checking the message, Device A sends a DT1 message back to Device B.

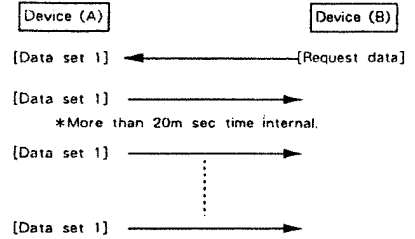

4. Handshake- Transfer Procedure

Handshaking is an interactive process where two devices exchange error checking signals before a message transaction takes place, thereby increasing data reliability. Unlike one-way transfer that inserts a pause between message transactions, handshake transfer allows much speedier transactions because data transfer starts once the receiving device returns a ready signal.

When it comes to handling large amounts of data— sampler waveforms and synthesizer tones over the entire range, for example— across a MIDI interface, handshaking transfer is more efficient than one-way transfer.

Types of Messages

Message	Command ID
Want to send data	WSD (40H)
Request data	RQD (41H)
Data set	DAT (42H)
Acknowledge	ACK (43H)
End of data	EOD (45H)
Communication error	ERR (4EH)
Rejection	RJC (4FH)

Want to send data : WSD (40H)

This message is sent out when data must be sent to a device at the other end of the interface. It contains data for the address and size that specify designation and length, respectively, of the data to be sent.

On receiving a WSD message, the remote device checks its memory for the specified data address and size which will satisfy the request. If it finds them and is ready for communication, the device will return an "Acknowledge (ACK)" message. Otherwise, it will return a "Rejection (RJC)" message.

Byte	Description
F0H	Exclusive status
41H	Manufacturer ID (Roland)
DEV	Device ID
MDL	Model ID
40H	Command ID
aaH	Address MSB
⋮	⋮
	LSB
ssH	Size MSB
⋮	⋮
	LSB
sum	Check sum
F7H	End of exclusive

- *The size of the data to be sent does not indicate the number of bytes that make up a "Data set (DAT)" message, but represents the address fields where the data should reside.
- *Some models are subject to limitations in data format used for a single transaction. Requested data, for example, may have a limit in length or must be divided into predetermined address fields before it is exchanged across the interface.
- *The same number of bytes comprises address and size data, which, however, vary with the Model-ID.
- *The error checking process uses a checksum that provides a bit pattern where the least significant 7 bits are zero when values for an address, size, and that checksum are summed.

Rejection : RJC (4FH)

This message is sent out when there is a need to terminate communication by overriding the current message. An RJC message will be triggered when :

- a WSI or RQD message has specified an illegal data address or size,
- the device is not ready for communication,
- an illegal number of addresses or data has been detected,
- data transfer has been terminated by an operator,
- a communications error has occurred.

An ERR message may be sent out by a device on either side of the interface. Communication must be terminated immediately when either side triggers an ERR message.

Byte	Description
F0H	Exclusive status
41H	Manufacturer ID (Roland)
DEV	Device ID
MDL	Model ID
4FH	Command ID
F7H	End of exclusive

Example of Message Transactions

● Data transfer from device (A) to device (B).

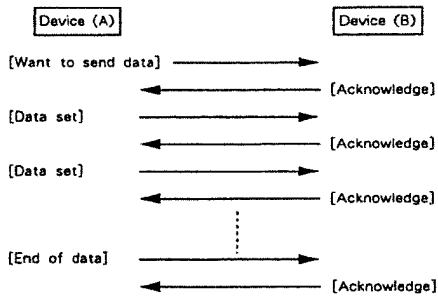

● Device (A) requests and receives data from device (B).

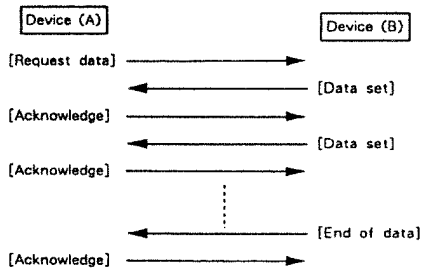

● Error occurs while device (A) is receiving data from device (B).

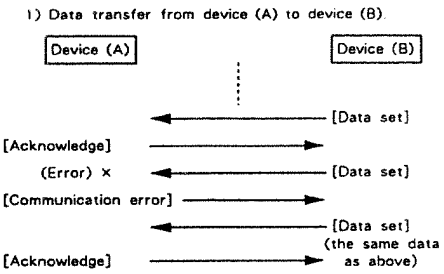

2) Device (B) rejects the data re-transmitted, and quits data transfer.

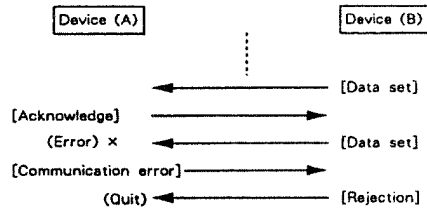

3) Device (A) immediately quits data transfer.

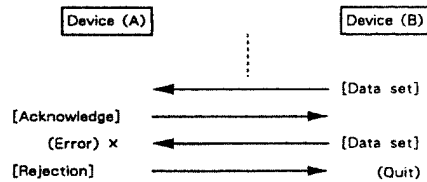

Request data : RQD (41H)

This message is sent out when there is a need to acquire data from a device at the other end of the interface. It contains data for the address and size that specify designation and length, respectively, of data required.

On receiving an RQD message, the remote device checks its memory for the data address and size which satisfy the request. If it finds them and is ready for communication, the device will transmit a "Data set (DAT)" message, which contains the requested data. Otherwise, it will return a "Rejection (RJC)" message.

Byte	Description
FOH	Exclusive status
41H	Manufacturer ID (Roland)
DEV	Device ID
MDL	Model ID
41H	Command ID
aaH	Address MSB
⋮	⋮
	LSB
ssH	Size MSB
⋮	⋮
	LSB
sum	Check sum
F7H	End of exclusive

*The size of the requested data does not indicate the number of bytes that make up a "Data set (DAT)" message, but represents the address fields where the requested data resides.

*Some models are subject to limitations in data format used for a single transaction. Requested data, for example, may have a limit in length or must be divided into predetermined address fields before it is exchanged across the interface.

*The same number of bytes comprises address and size data, which, however, vary with the Model-ID.

*The error checking process uses a checksum that provides a bit pattern where the least significant 7 bits are zero when values for an address, size, and that checksum are summed.

Data set : DAT (42H)

This message corresponds to the actual data transfer process. Because every byte in the data is assigned a unique address, the message can convey the starting address of one or more data as well as a series of data formatted in an address-dependent order.

Although the MIDI standards inhibit non-real time messages from interrupting an exclusive one, some devices support a "soft-through" mechanism for such interrupts. To maintain compatibility with such devices, Roland has limited the DAT to 256bytes so that an excessively long message is sent out in separate segments.

Byte	Description
FOH	Exclusive status
41H	Manufacturer ID (Roland)
DEV	Device ID
MDL	Model ID
42H	Command ID
aaH	Address MSB
⋮	⋮
	LSB
ddH	Data
⋮	⋮
sum	Check sum
F7H	End of exclusive

*A DAT message is capable of providing only the valid data among those specified by an RQD or WSD message.

*Some models are subject to limitations in data format used for a single transaction. Requested data, for example, may have a limit in length or must be divided into predetermined address fields before it is exchanged across the interface.

*The number of bytes comprising address data varies from one model ID to another.

*The error checking process uses a checksum that provides a bit pattern where the least significant 7 bits are zero when values for an address, size, and that checksum are summed.

Acknowledge : ACK (43H)

This message is sent out when no error was detected on reception of a WSD, DAT, "End of data (EOD)", or some other message and a requested setup or action is complete. Unless it receives an ACK message, the device at the other end will not proceed to the next operation.

Byte	Description
FOH	Exclusive status
41H	Manufacturer ID (Roland)
DEV	Device ID
MDL	Model ID
43H	Command ID
F7H	End of exclusive

End of data : EOD (45H)

This message is sent out to inform a remote device of the end of a message. Communication, however, will not come to an end unless the remote device returns an ACK message even though an EOD message was transmitted.

Byte	Description
FOH	Exclusive status
41H	Manufacturer ID (Roland)
DEV	Device ID
MDL	Model ID
45H	Command ID
F7H	End of exclusive

Communications error : ERR (4EH)

This message warns the remote device of a communications fault encountered during message transmission due, for example, to a checksum error. An ERR message may be replaced with a "Rejection (RJC)" one, which terminates the current message transaction in midstream.

When it receives an ERR message, the sending device may either attempt to send out the last message a second time or terminate communication by sending out an RJC message.

Byte	Description
FOH	Exclusive status
41H	Manufacturer ID (Roland)
DEV	Device ID
MDL	Model ID
4EH	Command ID
F7H	End of exclusive

1. RECOGNIZED RECEIVE DATA (SEQUENCER BLOCK)**1.1 Messages memorized in RECORD mode****■ Channel Voice Message****● Note off**

<u>Status</u>	<u>Second</u>	<u>Third</u>	
BnH	kkH	vvH	
9nH	kkH	00H	
n = MIDI channel number	: 0H - FH (0 - 15)	0 = ch.1 15 = ch.16	
kk = Note number	: 00H - 7FH (0 - 127)		
vv = Velocity	: 00H - 7FH (0 - 127)		

* 8n kk vv is memorized as 9n kk 00.

● Note on

<u>Status</u>	<u>Second</u>	<u>Third</u>	
9nH	kkH	vvH	
n = MIDI channel number	: 0H - FH (0 - 15)	0 = ch.1 15 = ch.16	
kk = Note number	: 00H - 7FH (0 - 127)		
vv = Velocity	: 01H - 7FH (1 - 127)		

● Polyphonic key pressure

<u>Status</u>	<u>Second</u>	<u>Third</u>	
AnH	kkH	vvH	
n = MIDI channel number	: 0H - FH (0 - 15)	0 = ch.1 15 = ch.16	
kk = Note number	: 00H - 7FH (0 - 127)		
vv = Value	: 00H - 7FH (0 - 127)		

* Received and memorized when AFT in MIDI config memory is ON.

● Control change

<u>Status</u>	<u>Second</u>	<u>Third</u>	
BnH	kkH	vvH	
n = MIDI channel number	: 0H - FH (0 - 15)	0 = ch.1 15 = ch.16	
kk = Control number	: 00H - 79H (0 - 121)		
vv = Value	: 00H - 7FH (0 - 127)		

* Received and memorized when CTRL in MIDI config memory is ON.

● Program change

<u>Status</u>	<u>Second</u>		
CnH	ppH		
n = MIDI channel number	: 0H - FH (0 - 15)	0 = ch.1 15 = ch.16	
pp = Program number	: 00H - 7FH (0 - 127)		

* Received and memorized when PROG in MIDI config memory is ON.

● Channel pressure

<u>Status</u>	<u>Second</u>		
DnH	vvH		
n = MIDI channel number	: 0H - FH (0 - 15)	0 = ch.1 15 = ch.16	
vv = Value	: 00H - 7FH (0 - 127)		

* Received and memorized when AFT in MIDI config memory is ON.

● Pitch bend change

<u>Status</u>	<u>Second</u>	<u>Third</u>	
EnH	mmH	llH	
n = MIDI channel number	: 0H - FH (0 - 15)	0 = ch.1 15 = ch.16	
ll,mm = Value	: 00H,00H - 7FH,7FH	0 - 16383 (- 8192 - + 8191)	

* Received and memorized when BEND in MIDI config memory is ON.

■ Channel Mode Message**● Local ON/OFF**

<u>Status</u>	<u>Second</u>	<u>Third</u>	
BnH	7AH	vvH	
n = MIDI channel number	: 0H - FH (0 - 15)	0 = ch.1 15 = ch.16	
vv = Value	: 00H - 7FH (0 - 127)		

* Received and memorized when CTRL in MIDI config memory is ON.

■ System Exclusive Message

<u>Status</u>	<u>data_byte</u>	
F0H	iiH,ddH,.....,eeH	
F7H		
F0H	: System Exclusive	
ii = ID number	: 00H - 7FH (0 - 127)	
dd,*** ee = data	: 00H - 7FH (0 - 127)	
F7H	: EOx (End of Exclusive/System common)	

* Received and memorized when EXCL in MIDI config memory is ON.

* The number of data bytes varies according to the setting of THRU.

■ System Common Message**● Tune request**

<u>Status</u>	
F6H	

1.2 Message not memorized in RECORD mode**■ Channel Mode Message****● All Notes off**

<u>Status</u>	<u>Second</u>	<u>Third</u>	
BnH	7BH	00H	
n = MIDI channel number	: 0H - FH (0 - 15)	0 = ch.1 15 = ch.16	

* When MT - 100 receives this message, it produces and memorized Note off message for notes remains on.

● OMNI OFF

<u>Status</u>	<u>Second</u>	<u>Third</u>	
BnH	7CH	00H	
n = MIDI channel number	: 0H - FH (0 - 15)	0 = ch.1 15 = ch.16	

* Recognized only as All Notes off.

● OMNI ON

<u>Status</u>	<u>Second</u>	<u>Third</u>	
BnH	7DH	00H	
n = MIDI channel number	: 0H - FH (0 - 15)	0 = ch.1 15 = ch.16	

* Recognized only as All Notes off.

● MONO

<u>Status</u>	<u>Second</u>	<u>Third</u>	
BnH	7EH	mmH	
n = MIDI channel number	: 0H - FH (0 - 15)	0 = ch.1 15 = ch.16	

* Recognized only as All Notes off.

● POLY

<u>Status</u>	<u>Second</u>	<u>Third</u>	
BnH	7FH	00H	
n = MIDI channel number	: 0H - FH (0 - 15)	0 = ch.1 15 = ch.16	

* Recognized only as All Notes off.

1.3 Recognized messages for sync.

Recognized when SYNC in MIDI config memory is set at EXT.

■ System Common Message

● Song position pointer

<u>Status</u>	<u>Second</u>	<u>Third</u>
F2H	mmH	llH

mm, ll = Value : 00H, 00H – 7FH, 7FH 0 – 16383

* Received when MT – 100 is in standby mode.

■ System Realtime Message

● Timing clock

<u>Status</u>
FBH

● Start

<u>Status</u>
FAH

● Continue

<u>Status</u>
FBH

● Stop

<u>Status</u>
FCH

2. TRANSMITTED DATA (SEQUENCER BLOCK)

2.1 MT – 100 transmits memorized message in playback mode.

2.2 When THRU in MIDI config memory is set at ON, MT – 100 transmits received message. (except System Common Message and System Realtime Message)

2.3 Created message

Messages are automatically created by system.

■ Channel Mode Message

● Local ON/OFF

<u>Status</u>	<u>Second</u>	<u>Third</u>
BnH	7AH	vvH

n = MIDI channel number : 0H – FH (0 – 15) 0 = ch.1 15 = ch.16
 vv = Value : 00H – 7FH (0 – 127)

* Transmitted according to the setting of THRU in MIDI config memory.

● All Notes off

<u>Status</u>	<u>Second</u>	<u>Third</u>
BnH	7BH	00H

n = MIDI channel number : 0H – FH (0 – 15) 0 = ch.1 15 = ch.16

* Transmitted when all notes are turned off in a specific channel.

● OMNI OFF

<u>Status</u>	<u>Second</u>	<u>Third</u>
BnH	7CH	00H

n = MIDI channel number : 0H – FH (0 – 15) 0 = ch.1 15 = ch.16

* Transmitted on all channel when power is first applied or when you use All Clear function.

● POLY

<u>Status</u>	<u>Second</u>	<u>Third</u>
BnH	7FH	00H

n = MIDI channel number : 0H – FH (0 – 15) 0 = ch.1 15 = ch.16

* Transmitted on all channel when power is first applied or when you use All Clear function.

■ System Realtime Message

● Active sensing

<u>Status</u>
FEH

2.4 Created messages for sync.

■ System Common Message

● Song position pointer

<u>Status</u>	<u>Second</u>	<u>Third</u>
F2H	mmH	llH

mm, ll = Value : 00H, 00H – 7FH, 7FH 0 – 16383

* Transmitted when CLK in MIDI config memory is ON.

■ System Realtime Message

● Timing clock

<u>Status</u>
FBH

* Transmitted when CLK in MIDI config memory is ON.

● Start

<u>Status</u>
FAH

* Transmitted when CLK in MIDI config memory is ON.

● Continue

<u>Status</u>
FBH

* Transmitted when CLK in MIDI config memory is ON.

● Stop

<u>Status</u>
FCH

* Transmitted when CLK in MIDI config memory is ON.

3. RECOGNIZED RECEIVE DATA (SOUND MODULE BLOCK)

3.1 Parts 1 – 8

■ Channel Voice Message

● Note off

<u>Status</u>	<u>Second</u>	<u>Third</u>
BnH	kkH	vvH
9nH	kkH	00H

n = MIDI channel number : 0H – FH (0 – 15) 0 = ch.1 15 = ch.16
 kk = Note number : 00H – 7FH (0 – 127)
 vv = Velocity : 00H – 7FH (0 – 127) : ignored

* A tone whose envelope mode is "NO SUS" ignores Note off message.

● Note on

<u>Status</u>	<u>Second</u>	<u>Third</u>
9nH	kkH	vvH

n = MIDI channel number : 0H - FH (0 - 15) 0 = ch.1 15 = ch.16
 kk = Note number : 00H - 7FH (0 - 127)
 vv = Velocity : 00H - 7FH (0 - 127)

*Notes numbers outside of the range 12 - 108 are transposed to the nearest octave inside the range.

● **Control change**

○ **Modulation depth**

Status	Second	Third
BnH	01H	wH

n = MIDI channel number : 0H - FH (0 - 15) 0 = ch.1 15 = ch.16
 vv = Modulation depth : 00H - 7FH (0 - 127)

○ **Data entry**

Status	Second	Third
BnH	06H	wH

n = MIDI channel number : 0H - FH (0 - 15) 0 = ch.1 15 = ch.16
 vv = Value of a parameter specified by RPN.

○ **Volume**

Status	Second	Third
BnH	07H	wH

n = MIDI channel number : 0H - FH (0 - 15) 0 = ch.1 15 = ch.16
 vv = Volume : 00H - 7FH (0 - 127)

*Controls the volume of a part accessible through the receive MIDI channel. The maximum volume is determined by MASTER VOLUME and Expression message.

○ **Pan**

Status	Second	Third
BnH	0AH	wH

n = MIDI channel number : 0H - FH (0 - 15) 0 = ch.1 15 = ch.16
 vv = Pan : 00H - 7FH (0 - 127)

*Orientation of sound is as follows.
 127 = LEFT, 63 = CENTER, 0 = RIGHT

○ **Expression**

Status	Second	Third
BnH	0BH	wH

n = MIDI channel number : 0H - FH (0 - 15) 0 = ch.1 15 = ch.16
 vv = Expression : 00H - 7FH (0 - 127)

*Controls the volume of a part accessible through the receive MIDI channel. The maximum volume is determined by MASTER VOLUME and Volume message.

○ **Hold 1**

Status	Second	Third
BnH	40H	vvH

n = MIDI channel number : 0H - FH (0 - 15) 0 = ch.1 15 = ch.16
 vv = 00H - 3FH : off
 vv = 40H - 7FH : on

○ **RPN LSB**

Status	Second	Third
BnH	64H	wH

n = MIDI channel number : 0H - FH (0 - 15) 0 = ch.1 15 = ch.16
 vv = The lower byte of a RPN (registered parameter number).

○ **RPN MSB**

Status	Second	Third
BnH	65H	wH

n = MIDI channel number : 0H - FH (0 - 15) 0 = ch.1 15 = ch.16
 vv = The upper byte of a RPN (registered parameter number).

*Using RPN, MT - 100's parameter can be controlled by Control change message. RPN MSB and LSB specify the parameter to be controlled while Data entry sets the parameter value. Effective RPN to MT - 100 is Pitch bend sensitivity.

RPN MSB LSB	Data entry	Description
00H 00H	vvH vv = 0 - 24	Pitch bend sensitivity Unit in semitone, 2 octaves maximum

○ **Reset all controllers**

Status	Second	Third
BnH	78H	00H

n = MIDI channel number : 0H - FH (0 - 15) 0 = ch.1 15 = ch.16

*Set each of the following controls as follows.

Controller	Setting
Moduration depth	OFF (0)
Expression	Max (127)
Hold 1	OFF (0)
Pitch bend change	CENTER

● **Program change**

Status	Second
CnH	ppH

n = MIDI channel number : 0H - FH (0 - 15) 0 = ch.1 15 = ch.16
 pp = Program number : 00H - 7FH (0 - 127)

*Program change message is used to change Patches.

● **Pitch bend change**

Status	Second	Third
EnH	mmH	llH

n = MIDI channel number : 0H - FH (0 - 15) 0 = ch.1 15 = ch.16
 ll,mm = Value : 00H,00H - 7FH,7FH 0 - 16383 (- 8192 - + 8191)

■ **Channel Mode Message**

● **All Notes off**

Status	Second	Third
BnH	7BH	00H

n = MIDI channel number : 0H - FH (0 - 15) 0 = ch.1 15 = ch.16

*Turn off all notes remaining on.

● **OMNI OFF**

Status	Second	Third
BnH	7CH	00H

n = MIDI channel number : 0H - FH (0 - 15) 0 = ch.1 15 = ch.16

*Recognized as only All notes off.

● **OMNI ON**

Status	Second	Third
BnH	7DH	00H

n = MIDI channel number : 0H - FH (0 - 15) 0 = ch.1 15 = ch.16

*Recognized as only All notes off.

● **MONO**

Status	Second	Third
BnH	7EH	mmH

n = MIDI channel number : 0H - FH (0 - 15) 0 = ch.1 15 = ch.16
 mm = MONO channel range : ignored

*Recognized as only All notes off.

●POLY

<u>Status</u>	<u>Second</u>	<u>Third</u>	
BnH	7FH	00H	

n = MIDI channel number : 0H - FH (0 - 15) 0 = ch.1 15 = ch.16

* Recognized as only All notes off.

■System Exclusive Message

<u>Status</u>	
FOH	: System Exclusive
F7H	: EOX (End of Exclusive)

*Using System Exclusive Message, a set of parameters for a timbre or individual parameters in a patch or timbre can be transferred to MT - 100. Refer to Roland Exclusive Messages and Sections 4 and 5.

3.2 RHYTHM Part

Messages on MIDI channels not assigned to rhythm part are ignored.

■Channel Voice Message

●Note off

<u>Status</u>	<u>Second</u>	<u>Third</u>	
8nH	kkH	vvH	
9nH	kkH	00H	

n = MIDI channel number : 0H - FH (0 - 15) 0 = ch.1 15 = ch.16
 kk = Note number : 18H - 57H (24 - 87)
 vv = Velocity : ignored

* A tone whose envelope mode is "NO SUS" ignores Note off message.

●Note on

<u>Status</u>	<u>Second</u>	<u>Third</u>	
8nH	kkH	vvH	

n = MIDI channel number : 0H - FH (0 - 15) 0 = ch.1 15 = ch.16
 kk = Note number : 18H - 57H (24 - 87)
 vv = Velocity : 01H - 7FH (1 - 127)

* Notes numbers outside of the range 24 - 87 are ignored.

●Control change

○Data entry

<u>Status</u>	<u>Second</u>	<u>Third</u>	
BnH	06H	vvH	

n = MIDI channel number : 0H - FH (0 - 15) 0 = ch.1 15 = ch.16
 vv = Value of a parameter specified by RPN.

○Volume

<u>Status</u>	<u>Second</u>	<u>Third</u>	
BnH	07H	vvH	

n = MIDI channel number : 0H - FH (0 - 15) 0 = ch.1 15 = ch.16
 vv = Volume : 00H - 7FH (0 - 127)

* Controls the volume of a part accessible through the receive MIDI channel. The maximum volume is determined by MASTER VOLUME and Expression message.

○Expression

<u>Status</u>	<u>Second</u>	<u>Third</u>	
BnH	0BH	vvH	

n = MIDI channel number : 0H - FH (0 - 15) 0 = ch.1 15 = ch.16
 vv = Expression : 00H - 7FH (0 - 127)

* Controls the volume of a part accessible through the receive MIDI channel. The maximum volume is determined by MASTER VOLUME and Volume message.

○RPN LSB

<u>Status</u>	<u>Second</u>	<u>Third</u>	
BnH	64H	vvH	

n = MIDI channel number : 0H - FH (0 - 15) 0 = ch.1 15 = ch.16
 vv = The lower byte of a RPN (registered parameter number).

○RPN MSB

<u>Status</u>	<u>Second</u>	<u>Third</u>	
BnH	65H	vvH	

n = MIDI channel number : 0H - FH (0 - 15) 0 = ch.1 15 = ch.16
 vv = The upper byte of a RPN (registered parameter number).

* RPN MSB and LSB together specifies parameter to be controlled while Data entry determines the value.

Effective RPN to MT - 100 is Pitch bend sensitivity.

RPN	Data entry	Description
<u>MSB LSB</u>		
00H 00H	vvH	Pitch bend sensitivity
	vv = 0 - 24	Unit in semitone, 2 octave maximum

○Reset All Controllers

<u>Status</u>	<u>Second</u>	<u>Third</u>	
BnH	79H	00H	

n = MIDI channel number : 0H - FH (0 - 15) 0 = ch.1 15 = ch.16

* Set each of the following controls as follows.

Controller	Setting
Modulation depth	OFF (0)
Expression	Max (127)
Hold 1	OFF (0)
Pitch bend change	CENTER

●Pitch bend change

<u>Status</u>	<u>Second</u>	<u>Third</u>	
EnH	mmH	llH	

n = MIDI channel number : 0H - FH (0 - 15) 0 = ch.1 15 = ch.16
 ll,mm = Value : 00H,00H - 7FH,7FH 0 - 16383 (- 8192 - + 8191)

■System Exclusive Message

<u>Status</u>	
FOH	: System Exclusive
F7H	: EOX (End Of Exclusive)

*Using System Exclusive Message, a set of parameters for a timbre or individual parameters in a patch or timbre can be transferred to MT - 100. Refer to Roland Exclusive Messages and Sections 4 and 5.

4. EXCLUSIVE COMMUNICATIONS

Parameters for patches or timbres can be transferred to MT - 100 through System Exclusive Message.

Model ID # of MT - 100 is 16H.

In a system where more than one MIDI channel is assigned to MT - 100, Unit # 17 (device ID = 10H) is set to the MT - 100. The advantage of Unit # is that a specific part is made accessible independent of MIDI channel of the part.

■One way communication

Data set	DT1 12H
Byte	Description
FOH	Exclusive Status
41H	Manufacturer's ID (Roland)
17H	Device ID
16H	Model ID (MT - 32)
12H	Command ID (DT1)
aaH	Address MSB
aaH	Address
aaH	Address LSB
ddH	Data
:	
sum	Check sum
F7H	EOX (End of Exclusive/System Common)

5.PARAMETER ADDRESS MAP

Address are represented in 7-bit hexadecimal.

Address	MSB		LSB
Binary	0aaa aaaa	0bbb bbbb	0ccc cccc
7-bit Hexadecimal	AA	BB	CC

The actual address of a parameter is a sum of the start address of each block and one or more offset address.

■ Parameter base address

Temporary area (Accessed on each basic channel)

Start address	Description	
02 00 00	Timbre Temporary Area (part 1 - 8)	*5-1

Whole part (Accessible on UNIT #)

Start address	Description	
03 00 00	Patch Temporary Area(part 1)	*5-2
03 00 10	Patch Temporary Area(part 2)	
:	:	
03 00 80	Patch Temporary Area(part 7)	
03 00 70	Patch Temporary Area(part 8)	
03 01 00	Patch Temporary Area(rhythm part)	
03 01 10	Rhythm Setup Temporary res	*5-3
04 00 00	Timbre Temporary Area(part 1)	*5-1
04 01 78	Timbre Temporary Area(part 2)	
:	:	
04 08 44	Timbre Temporary Area(part 7)	
04 00 3A	Timbre Temporary Area (part 8)	
05 00 00	Patch Memory #1	*5-4
05 00 08	Patch Memory #2	
:	:	
05 07 70	Patch Memory #127	
05 07 78	Patch Memory #128	
08 00 00	Timbre Memory #1	*5-1
08 02 00	Timbre Memory #2	
:	:	
08 7C 00	Timbre Memory #63	
08 7E 00	Timbre Memory #64	
10 00 00	System area	*5-5
20 00 00	Display	*5-6
40 00 00	Write Request	*5-7
7F xx xx	All parameter reset	*5-8

Notes :

* 5 - 1 Timbre Temporary area / Timbre Memory

Offset address	Description	
00 00 00	Common parameter	*5-1-1
00 00 0E	Partial parameter (for Partial# 1)	*5-1-2
00 00 48	Partial parameter (for Partial# 2)	
00 01 02	Partial parameter (for Partial# 3)	
00 01 3C	Partial parameter (for Partial# 4)	

* 5-1-1 Common Parameter

Offset address	Description	
00	0aaa aaaa TIMBRE NAME 1	32 - 127 (ASCII)
:	:	:
09	0aaa aaaa TIMBRE NAME 10	
0A	0000 aaaa Structure of Partial# 1 & 20	12 - 13 (1-13)
0B	0000 aaaa Structure of Partial# 3 & 40	12 - 13 (1-13)
0C	0000 aaaa PARTIAL MUTE	0 - 15 (0000-1111)
0D	0000 000a ENV MODE	0 - 1 (Normal, No sustain)
Total size	00 00 0E	

* 5-1-2 Partial Parameter

Offset address	Description	
00 00	0aaa aaaa WG PITCH COARSE	0 - 96 (C1, C#1, -C9)
00 01	0aaa aaaa WG PITCH FINE	0 - 100 (-50-+50)
00 02	0000 aaaa WG PITCH KEYFOLLOW	0 - 16 (-1, -1/2, -1/4, 0, 1/8, 1/4, 3/8, 1/2, 5/8, 3/4, 7/8, 1, 5/4, 3/2, 2, s1, s2)
00 03	0000 000a WG PITCH BENDER SW	0 - 1 (OFF, ON)
00 04	0000 000a WG WAVEFORM	0 - 1 (SQU, SAW)
00 05	0aaa aaaa WG PCM WAVE #	0 - 127 (1 - 128)
00 06	0aaa aaaa WG PULSE WIDTH	0 - 100
00 07	0000 aaaa WG PW VELO SENS	0 - 14 (-7 - +7)
00 08	0000 aaaa P-ENV DEPTH	0 - 10
00 09	0aaa aaaa P-ENV VELO SENS	0 - 100
00 0A	0000 0aaa P-ENV TIME KEYF	0 - 4
00 0B	0aaa aaaa P-ENV TIME 1	0 - 100
00 0C	0aaa aaaa P-ENV TIME 2	0 - 100
00 0D	0aaa aaaa P-ENV TIME 3	0 - 100
00 0E	0aaa aaaa P-ENV TIME 4	0 - 100
00 0F	0aaa aaaa P-ENV LEVEL 0	0 - 100 (-50 - +50)
00 10	0aaa aaaa P-ENV LEVEL 1	0 - 100 (-50 - +50)
00 11	0aaa aaaa P-ENV LEVEL 2	0 - 100 (-50 - +50)
00 12	0xxx xxxx P-ENV SUSTAIN LEVEL	0 - 100 (-50 - +50)
00 13	0aaa aaaa END LEVEL	0 - 100 (-50 - +50)
00 14	0aaa aaaa P-LFO RATE	0 - 100
00 15	0aaa aaaa P-LFO DEPTH	0 - 100
00 16	0aaa aaaa P-LFO MOD SENS	0 - 100
00 17	0aaa aaaa TVF CUTOFF FREQ	0 - 100
00 18	000a aaaa TVF RESONANCE	0 - 30
00 19	0000 aaaa TVF KEYFOLLOW	0 - 14 (-1, -1/2, -1/4, 0, 1/8, 1/4, 3/8, 1/2, 5/8, 3/4, 7/8, 1, 5/4, 3/2, 2)
00 1A	0aaa aaaa TVF BIAS POINT/DIR	0 - 127 (< 1A - < 7C > 1A - > 7C)
00 1B	0000 aaaa TVF BIAS LEVEL	0 - 14 (-7 - +7)

00 1C	0aaa aaaa	TVF ENV DEPTH	0 - 100
00 1D	0aaa aaaa	TVF ENV VELO SENS	0 - 100
00 1E	0000 0aaa	TVF ENV DEPTH KEYF	0 - 4
00 1F	0000 0aaa	TVF ENV TIME KEYF	0 - 4
00 20	0aaa aaaa	TVF ENV TIME 1	0 - 100
00 21	0aaa aaaa	TVF ENV TIME 2	0 - 100
00 22	0aaa aaaa	TVF ENV TIME 3	0 - 100
00 23	0aaa aaaa	TVF ENV TIME 4	0 - 100
00 24	0aaa aaaa	TVF ENV TIME 5	0 - 100
00 25	0aaa aaaa	TVF ENV LEVEL 1	0 - 100
00 26	0aaa aaaa	TVF ENV LEVEL 2	0 - 100
00 27	0aaa aaaa	TVF ENV LEVEL 3	0 - 100
00 28	0aaa aaaa	TVF ENV SUSTAIN LEVEL	0 - 100

00 29	0aaa aaaa	TVA LEVEL	0 - 100
00 2A	0aaa aaaa	TVA VELO SENS	0 - 100
		(-50 - +50)	
00 2B	0aaa aaaa	TVA BIAS POINT 1	0 - 127
		(<1A - <7C >1A - >7C)	
00 2C	0000 aaaa	TVA BIAS LEVEL 1	0 - 12
		(-12 - 0)	
00 2D	0aaa aaaa	TVA BIAS POINT 2	0 - 127
		(<1A - <7C >1A - >7C)	
00 2E	0000 aaaa	TVA BIAS LEVEL 2	0 - 12
		(-12 - 0)	

00 2F	0000 0aaa	TVA ENV TIME KEYF	0 - 4
00 30	0000 0aaa	TVA ENV TIME V_FOLLOW	0 - 4
00 31	0aaa aaaa	TVA ENV TIME 1	0 - 100
00 32	0aaa aaaa	TVA ENV TIME 2	0 - 100
00 33	0aaa aaaa	TVA ENV TIME 3	0 - 100
00 34	0aaa aaaa	TVA ENV TIME 4	0 - 100
00 35	0aaa aaaa	TVA ENV TIME 5	0 - 100
00 36	0aaa aaaa	TVA ENV LEVEL 1	0 - 100
00 37	0aaa aaaa	TVA ENV LEVEL 2	0 - 100
00 38	0aaa aaaa	TVA ENV LEVEL 3	0 - 100
00 39	0aaa aaaa	TVA ENV SUSTAIN LEVEL	0 - 100

Total size			00 00 3A

* 5-2 Patch temporary area

Offset address	Description
00 00	0000 0aaa TIMBRE GROUP - 3 (a, b, i, r)
00 01	00aa aaaa TIMBRE NUMBER - 63 (1 - 64)
00 02	00aa aaaa KEY SHIFTO - 48 (-24 - +24)
00 03	0aaa aaaa FINE TUNED - 100 (-50 - +50)
00 04	000a aaaa BENDER RANGEO - 24
00 05	0000 00aa ASSIGN MODEO - 3 (POLY 1, POLY 2, POLY 3, POLY 4)
00 06	0000 0aaa REVERB SWITCHO - 1 (OFF, ON)
00 07	0xxx xxxx dummy (ignored if received)
00 08	0aaa aaaa OUTPUT LEVELO - 100
00 09	0000 aaaa PANPOTO - 14 (R - L)
00 0A	0xxx xxxx dummy (ignored if received)
:	:
00 0F	0xxx xxxx dummy (ignored if received)

Total size	00 00 10

* 5-3 Rhythm part setup area

Offset address	Description
00 00 00	Rhythm Setup (for Key# 24) #5-3-1
00 00 04	Rhythm Setup (for Key# 25)
00 00 08	Rhythm Setup (for Key# 26)
00 00 0C	Rhythm Setup (for Key# 27)
00 00 10	Rhythm Setup (for Key# 28)
:	:
:	:
00 01 78	Rhythm Setup (for Key# 86)
00 01 7C	Rhythm Setup (for Key# 87)

* 5-3-1 Rhythm setup (for each Key#)

Offset address	Description
00 00	0aaa aaaa TIMBRE 0 - 127 (i01-i64, r01-r64)
00 01	0aaa aaaa OUTPUT LEVEL 0 - 100
00 02	0000 aaaa PANPOT 0 - 14 (R - L)
00 03	0000 000a REVERB SWITCH 0 - 1 (OFF, ON)

Total size	00 00 04

* 5-4 Patch memory

Offset address	Description
00 00	0000 00aa TIMBRE GROUP 0 - 3 (a, b, i, r)
00 01	00aa aaaa TIMBRE NUMBER 0 - 63
00 02	00aa aaaa KEY SHIFT 0 - 48 (-24 - +24)
00 03	0aaa aaaa FINE TUNE 0 - 100 (-50 - +50)
00 04	000a aaaa BENDER RANGE 0 - 24
00 05	0000 00aa ASSIGN MODE 0 - 3 (POLY 1, POLY 2, POLY 3, POLY 4)
00 06	0000 0aaa REVERB SWITCH 0 - 1 (OFF, ON)
00 07	0xxx xxxx dummy

Total size	00 00 08

* 5-5 System area

The total number of Partial reserves for 9 parts must be 32 or less. All Partial reserves must be sent as a package of 9 parts.

Offset address	Description
00 00	0aaa aaaa MASTER TUNE 0 - 127 (432.1Hz - 457.6Hz)
00 01	0000 00aa REVERB MODE 0 - 3 (Room, Hall, Plate, Tap delay)
00 02	0000 0aaa REVERB TIME 0 - 7 (1 - 8)
00 03	0000 0aaa REVERB LEVEL 0 - 7

00 04	00aa aaaa PARTIAL RESERVE (Part 1) 0 - 32
00 05	00aa aaaa PARTIAL RESERVE (Part 2) 0 - 32
:	:
:	:

00 06	00aa aaaa	PARTIAL RESERVE (Part 3)	0 - 32
00 07	00aa aaaa	PARTIAL RESERVE (Part 4)	0 - 32
00 08	00aa aaaa	PARTIAL RESERVE (Part 5)	0 - 32
00 09	00aa aaaa	PARTIAL RESERVE (Part 6)	0 - 32
00 0A	00aa aaaa	PARTIAL RESERVE (Part 7)	0 - 32
00 0B	00aa aaaa	PARTIAL RESERVE (Part 8)	0 - 32
00 0C	00aa aaaa	PARTIAL RESERVE (Part R)	0 - 32

00 0D	000a aaaa	MIDI CHANNEL (Part 1)	0 - 16 (1 - 16, OFF)
00 0E	000a aaaa	MIDI CHANNEL (Part 2)	0 - 16 (1 - 16, OFF)
00 0F	000a aaaa	MIDI CHANNEL (Part 3)	0 - 16 (1 - 16, OFF)
00 10	000a aaaa	MIDI CHANNEL (Part 4)	0 - 16 (1 - 16, OFF)
00 11	000a aaaa	MIDI CHANNEL (Part 5)	0 - 16 (1 - 16, OFF)
00 12	000a aaaa	MIDI CHANNEL (Part 6)	0 - 16 (1 - 16, OFF)
00 13	000a aaaa	MIDI CHANNEL (Part 7)	0 - 16 (1 - 16, OFF)
00 14	000a aaaa	MIDI CHANNEL (Part 8)	0 - 16 (1 - 16, OFF)
00 15	000a aaaa	MIDI CHANNEL (Part R)	0 - 16 (1 - 16, OFF)

00 16	0aaa aaaa	MASTER VOLUME	0 - 100

Total size	00 00 17		

Example

Set Partial reserve of each part as follows by sending the byte string listed below.

Part 1--- 8
 Part 2--- 10
 Part 3through8 --- 0
 Rhythm part --- 8

F0 41 10 16 12 10 00 04 08 0A 00 00 00 00 00 08 66 F7

* 5-6 Write Request

Offset address	Description
00 00	00aa aaaa Timbre Write (part 1) 0 - 63 (01 - 64)
00 01	0000 0000 0 (Internal)
00 02	00aa aaaa Timbre Write (part 2)
00 03	0000 0000 :
:	:
00 0E	00aa aaaa Timbre Write (part 8)
00 0F	0000 0000 :
01 00	0aaa aaaa Patch Write (part 1) 0 - 127 (All - B88)
01 01	0000 0000 0 (Internal)
01 02	0aaa aaaa Patch Write (part 2)
01 03	0000 0000 :
:	:
01 0E	0aaa aaaa Patch Write (part 8)
01 0F	0000 0000 :

*5-7 All Parameters Reset
 All parameters will be initialized by sending data to this address.

Address Map

Address	Block	Sub Block	Reference
02 00 00	Timbre Temp. (Basic Ch)	Common	5-1-1
:	:	Partial 1	5-1-2
:	:	Partial 2	:
:	:	Partial 3	:
:	:	Partial 4	:
03 00 00	Patch Temp. (Unit#)	Part 1	5-2
:	:	Part 2	:
:	:	:	:
:	:	Part 8	:
:	:	Part R	:
03 01 10	Rhythm Setup Temp(Unit#)	Note# 24	5-3-1
:	:	Note# 25	:
:	:	:	:
:	:	Note# 88	:
:	:	Note# 87	:
04 00 00	Timbre Temp. (Unit#)	Part 1	5-1
:	:	Part 2	:
:	:	:	:
:	:	Part 7	:
:	:	Part 8	:
05 00 00	Patch Memory	# 1	5-4
:	:	# 2	:
:	:	:	:
:	:	# 127	:
:	:	# 128	:
08 00 00	Timbre Memory	# 1	5-1
:	:	# 2	:
:	:	:	:
:	:	# 63	:
:	:	# 64	:
10 00 00	System Area		5-5
20 00 00			
40 00 00	Write Request		5-6
7F xx xx	All Parameters Reset		5-7

*5-8 Address Mapping of Parameters (Compatible with D-50 (PG-1000))

■Parameter base address

Start address	Description	
00-00-00	Partial 3	(0 - 53)
00-00-40	Partial 4	(64 - 117)
00-01-0A	Upper Common	(138 - 175)
00-01-40	Partial 1	(192 - 245)
00-02-00	Partial 2	(256 - 309)
00-02-4A	Lower Common	(330 - 367)

■Partial parameters

Offset address	Description	
00 00H 0aaa aaaa	WG PITCH COARSE	0 - 72 (C1, C2, - C7)
00 01H 0aaa aaaa	WG PITCH FINE	0 - 100 (-50 - +50)
00 02H 0000 aaaa	WG PITCH KEYFOLLOW	0 - 16 (-1, -1/2, -1/4, 0, 1/8, 1/4, 3/8, 1/2, 5/8, 3/4, 7/8, 1, 5/4, 3/2, 2, sl, s2)
00 03H 0xxx xxxx	dummy	
00 04H 0xxx xxxx	dummy	
00 05H 0000 000a	WG PITCH BENDER SW	0 - 1 (OFF, ON)
00 06H 0000 000a	WG WAVEFORM	0 - 1 (S0U, SA)
00 07H 0aaa aaaa	WG PCM WAVE #	0 - 99 (1 - 100)
00 08H 0aaa aaaa	WG PULSE WIDTH	0 - 100
00 09H 0000 aaaa	WG PW VELO SENS	0 - 14 (-7 - +7)
00 0AH 0xxx xxxx	dummy	
00 0BH 0xxx xxxx	dummy	
00 0CH 0xxx xxxx	dummy	
00 0DH 0aaa aaaa	TVF CUTOFF FREQ	0 - 100
00 0EH 000a aaaa	TVF RESONANCE	0 - 30
00 0FH 0000 aaaa	TVF KEYFOLLOW	0 - 14 (-1, -1/2, -1/4, 0, 1/8, 1/4, 3/8, 1/2, 5/8, 3/4, 7/8, 1, 5/4, 3/2, 2)
00 10H 0aaa aaaa	TVF BIAS POINT/DIR	0 - 127 (<1A - <7C >1A - >7C)
00 11H 0000 aaaa	TVF BIAS LEVEL	0 - 14 (-7 - +7)
00 12H 0aaa aaaa	TVF ENV DEPTH	0 - 100
00 13H 0aaa aaaa	TVF ENV VELO SENS	0 - 100
00 14H 0000 0aaa	TVF ENV DEPTH KEYF	0 - 4
00 15H 0000 0aaa	TVF ENV TIME KEYF	0 - 4
00 16H 0aaa aaaa	TVF ENV TIME 1	0 - 100
00 17H 0aaa aaaa	TVF ENV TIME 2	0 - 100
00 18H 0aaa aaaa	TVF ENV TIME 3	0 - 100
00 19H 0aaa aaaa	TVF ENV TIME 4	0 - 100
00 1AH 0aaa aaaa	TVF ENV TIME 5	0 - 100
00 1BH 0aaa aaaa	TVF ENV LEVEL 1	0 - 100
00 1CH 0aaa aaaa	TVF ENV LEVEL 2	0 - 100
00 1DH 0aaa aaaa	TVF ENV LEVEL 3	0 - 100
00 1EH 0aaa aaaa	TVF ENV SUSTAIN LEVEL	0 - 100
00 1FH 0xxx xxxx	dummy	
00 22H 0xxx xxxx	dummy	
00 23H 0aaa aaaa	TVA LEVEL	0 - 100
00 24H 0aaa aaaa	TVA VELO SENS	0 - 100
00 25H 0aaa aaaa	TVA BIAS POINT 1	0 - 127

Offset address	Description	
00 26H 0000 aaaa	TVA BIAS LEVEL 1	0 - 12 (-12 - 0)
00 27H 0aaa aaaa	TVA ENV TIME 1	0 - 100
00 28H 0aaa aaaa	TVA ENV TIME 2	0 - 100
00 29H 0aaa aaaa	TVA ENV TIME 3	0 - 100
00 2AH 0aaa aaaa	TVA ENV TIME 4	0 - 100
00 2BH 0aaa aaaa	TVA ENV TIME 5	0 - 100
00 2CH 0aaa aaaa	TVA ENV LEVEL 1	0 - 100
00 2DH 0aaa aaaa	TVA ENV LEVEL 2	0 - 100
00 2EH 0aaa aaaa	TVA ENV LEVEL 3	0 - 100
00 2FH 0aaa aaaa	TVA ENV SUSTAIN LEVEL	0 - 100
00 30H 0xxx xxxx	dummy	
00 31H 0000 0aaa	TVA ENV TIME V_FOLLOW	0 - 4
00 32H 0000 0aaa	TVA ENV TIME KEYF	0 - 4
00 33H 0xxx xxxx	dummy	
00 34H 0xxx xxxx	dummy	
00 35H 0xxx xxxx	dummy	
Total size		00 00 36H

■Lower common parameter

Offset address	Description	
00 00H 0000 aaaa	Structure of Partial# 1 & 2	0 - 12 (1 - 13)
00 01H 0aaa aaaa	P-ENV VELO SENS(Partial#1)	0 - 100
00 02H 0000 0aaa	P-ENV TIME KEYF(Partial#1)	0 - 4
00 03H 0aaa aaaa	P-ENV TIME 1(Partial#1)	0 - 100
00 04H 0aaa aaaa	P-ENV TIME 2(Partial#1)	0 - 100
00 05H 0aaa aaaa	P-ENV TIME 3(Partial#1)	0 - 100
00 06H 0aaa aaaa	P-ENV TIME 4(Partial#1)	0 - 100
00 07H 0aaa aaaa	P-ENV LEVEL 0(Partial#1)	0 - 100 (-50 - +50)
00 08H 0aaa aaaa	P-ENV LEVEL 1(Partial#1)	0 - 100 (-50 - +50)
00 09H 0aaa aaaa	P-ENV LEVEL 2(Partial#1)	0 - 100 (-50 - +50)
00 0AH 0aaa aaaa	P-ENV SUS LEVEL(Partial#1)	0 - 100 (-50 - +50)
00 0BH 0aaa aaaa	END LEVEL(Partial#1)	0 - 100 (-50 - +50)
00 0CH 0xxx xxxx	dummy	
00 0DH 0aaa aaaa	P-LFD MOD SENS(Partial#1)	0 - 100
00 0EH 0aaa aaaa	P-LFD MOD SENS(Partial#2)	0 - 100
00 0FH 0xxx xxxx	dummy	
00 10H 0aaa aaaa	P-LFD RATE(Partial#1)	0 - 100
00 11H 0aaa aaaa	P-LFD DEPTH(Partial#1)	0 - 100
00 12H 0xxx xxxx	dummy	
00 13H 0xxx xxxx	dummy	
00 14H 0aaa aaaa	P-LFD RATE(Partial#2)	0 - 100
00 15H 0aaa aaaa	P-LFD DEPTH(Partial#2)	0 - 100
00 16H 0xxx xxxx	dummy	
00 23H 0xxx xxxx	dummy	
00 24H 0000 00aa	PARTIAL MUTE(Partial# 1&2)	0 - 3 (00 - 11)
00 25H 0xxx xxxx	dummy	
Total size		00 00 26H

:
:
:

■ Upper common parameter

Offset address	Description	
00 00H	0000 aaaa	Structure of Partial# 3 & 4 0 - 12 (1 - 13)
00 01H	0aaa aaaa	P-ENV VELO SENS(Partial#3) 0 - 100
00 02H	0000 0aaa	P-ENV TIME KEYF(Partial#3) 0 - 4
00 03H	0aaa aaaa	P-ENV TIME 1(Partial#3) 0 - 100
00 04H	0aaa aaaa	P-ENV TIME 2(Partial#3) 0 - 100
00 05	0aaa aaaa	P-ENV TIME 3(Partial#3) 0 - 100
00 06H	0aaa aaaa	P-ENV TIME 4(Partial#3) 0 - 100
00 07H	0aaa aaaa	P-ENV LEVEL 0(Partial#3) 0 - 100 (-50 - +50)
00 08H	0aaa aaaa	P-ENV LEVEL 1(Partial#3) 0 - 100 (-50 - +50)
00 09H	0aaa aaaa	P-ENV LEVEL 2(Partial#3) 0 - 100 (-50 - +50)
00 0AH	0aaa aaaa	P-ENV SUS LEVEL(Partial#3) 0 - 100 (-50 - +50)
00 0BH	0aaa aaaa	END LEVEL(Partial#3) 0 - 100 (-50 - +50)
00 0CH	0xxx xxxx	dummy
00 0DH	0aaa aaaa	P-LFO MOD SENS(Partial#3) 0 - 100
00 0EH	0aaa aaaa	P-LFO MOD SENS(Partial#4) 0 - 100
00 0FH	0xxx xxxx	dummy
00 10H	0aaa aaaa	P-LFO RATE(Partial#3) 0 - 100
00 11H	0aaa aaaa	P-LFO DEPTH(Partial#3) 0 - 100
00 12H	0xxx xxxx	dummy
00 13H	0xxx xxxx	dummy
00 14H	0aaa aaaa	P-LFO RATE(Partial#4) 0 - 100
00 15H	0aaa aaaa	P-LFO DEPTH(Partial#4) 0 - 100
00 16H	0xxx xxxx	dummy
:	:	:
00 23H	0xxx xxxx	dummy
00 24H	0000 00aa	PARTIAL MUTE(Partial# 3&4) 0 - 3 (00 - 11)
00 25H	0xxx xxxx	dummy
Total size		00 00 26H

SOUND MODULE BLOCK

Function ***		Transmitted	Recognized	Remarks
Basic Channel	Default Changed	x x	2 - 10 x	
Mode	Default Messages Altered	x x *****	3 x	
Note Number	True Voice	x *****	0 - 127 12 - 108	
Velocity	Note ON Note OFF	x x	○ v = 1 - 127 x	
After Touch	Key's Ch's	x x	x x	
Pitch Bender		x	○	
Control Change	1	x	○	Modulation
	2 - 5	x	x	
	6	x	○	Data Entry * Volume
	7	x	○	
	6 - 9	x	x	Pan Expression
	10	x	○	
	11	x	○	Hold 1
	12 - 63	x	x	
	64	x	○	
	65 - 69	x	x	
100, 101	x	○	RPN LSB, MSB *	
102 - 120	x	x		
121	x	○	Resets All Controllers	
Prog Change	True #	x *****	○ (0 - 127) (0 - 127)	
System Exclusive		○	○	
System Common	Song Pos Song Sel Tune	x x x	x x x	
System Real Time	Clock Commands	x x	x x	
Aux Message	Local ON/OFF All Notes OFF Active Sense Reset	x x x x	x ○ (123 - 127) ○ x	
Notes	* RPN = Registered Parameter Number RPN 0 (00H, 00H) = Pitch Bend Sensitivity Data Entry sets the value of this parameter.			

Mode 1 : OMNI ON, POLY
 Mode 3 : OMNI OFF, POLY

Mode 2 : OMNI ON, MONO
 Mode 4 : OMNI OFF, MONO

○ : Yes
 x : No

-MT-100 Sound List

MT-100 Tone Name	Prog-No. [Hp-Prog]	Instrument Name	Used Partial	MT-100 Tone Name	Prog-No. [Hp-Prog]	Instrument Name	Used Partial
Piano1	001 [A11]	Acoustic Piano 1	4	Bass 1	065 [B11]	Acoustic Bass 1	2
Piano2	002 [A12]	Acoustic Piano 2	2	Bass 2	066 [B12]	Acoustic Bass 2	1
Piano3	003 [A13]	Acoustic Piano 3	1	EBass1	067 [B13]	Electric Bass 1	2
E. Pno1	004 [A14]	Electric Piano 1	3	EBass2	068 [B14]	Electric Bass 2	1
E. Pno2	005 [A15]	Electric Piano 2	2	SlapB1	069 [B15]	Slap Bass 1	3
E. Pno3	006 [A16]	Electric Piano 3	2	SlapB2	070 [B16]	Slap Bass 2	2
E. Pno4	007 [A17]	Electric Piano 4	1	FretB1	071 [B17]	Fretless Bass 1	4
H' tonk	008 [A18]	Honky tonk Piano	3	FretB2	072 [B18]	Fretless Bass 2	2
E' Org1	009 [A21]	Electric Organ 1	3	Flute1	073 [B21]	Flute 1	4
E' Org2	010 [A22]	Electric Organ 2	3	Flute2	074 [B22]	Flute 2	2
E' Org3	011 [A23]	Electric Organ 3	2	Picc 1	075 [B23]	Piccolo 1	3
E' Org4	012 [A24]	Electric Organ 4	2	Picc 2	076 [B24]	Piccolo 2	2
P' Org1	013 [A25]	Pipe Organ 1	3	Record	077 [B25]	Recorder	2
P' Org2	014 [A26]	Pipe Organ 2	3	P Pipe	078 [B26]	Pan Pipes	3
P' Org3	015 [A27]	Pipe Organ 3	2	Sax 1	079 [B27]	Saxophone 1	4
Accord	016 [A28]	Accordion	2	Sax 2	080 [B28]	Saxophone 2	3
Hrpsi1	017 [A31]	Harpsichord 1	4	Sax 3	081 [B31]	Saxophone 3	2
Hrpsi2	018 [A32]	Harpsichord 2	2	Sax 4	082 [B32]	Saxophone 4	1
Hrpsi3	019 [A33]	Harpsichord 3	1	Clari1	083 [B33]	Clarinet 1	3
Clavil	020 [A34]	Clavichord 1	3	Clari2	084 [B34]	Clarinet 1	2
Clavi2	021 [A35]	Clavichord 2	2	Oboe	085 [B35]	Oboe	2
Clavi3	022 [A36]	Clavichord 3	1	E Horn	086 [B36]	English Horn	2
Cste 1	023 [A37]	Celesta 1	4	B' soon	087 [B37]	Bassoon	2
Cste 2	024 [A38]	Celesta 2	2	Hrm' ca	088 [B38]	Harmonica	2
S. Brs1	025 [A41]	Synth. Brass 1	2	Trpt 1	089 [B41]	Trumpet 1	3
S. Brs2	026 [A42]	Synth. Brass 2	3	Trpt 2	090 [B42]	Trumpet 2	2
S. Brs3	027 [A43]	Synth. Brass 3	2	Trmb 1	091 [B43]	Trombone 1	3
S. Brs4	028 [A44]	Synth. Brass 4	2	Trmb 2	092 [B44]	Trombone 2	2
SynBs1	029 [A45]	Synth. Bass 1	2	F Hrnl	093 [B45]	French Horn 1	3
SynBs2	030 [A46]	Synth. Bass 2	2	F Hrnl2	094 [B46]	French Horn 2	2
SynBs3	031 [A47]	Synth. Bass 3	2	Tuba	095 [B47]	Tuba	2
SynBs4	032 [A48]	Synth. Bass 4	1	Brs S1	096 [B48]	Brass Section 1	4
F' tasy	033 [A51]	Fantasy	3	Brs S2	097 [B51]	Brass Section 2	3
H' pan	034 [A52]	Harmonic Pan	3	Vibe 1	098 [B52]	Vibraphone 1	3
Choral	035 [A53]	Chorale	3	Vibe 2	099 [B53]	Vibraphone 2	2
Glass	036 [A54]	Glasses	2	SMelet	100 [B54]	Synth. Mallet	1
S' Trak	037 [A55]	Soundtrack	4	Wind B	101 [B55]	Wind Bell	3
Atmos	038 [A56]	Atmosphere	4	Glock	102 [B56]	Glockenspiel	2
Warm B	039 [A57]	Warm Bell	4	Tube B	103 [B57]	Tube Bell	4
FunVox	040 [A58]	Funny Vox	1	Xylo	104 [B58]	Xylophone	1
Echo B	041 [A61]	Echo Bell	3	M'imba	105 [B61]	Marimba	3
Ice Rn	042 [A62]	Ice Rain	3	Koto	106 [B62]	Koto	2
Ob2001	043 [A63]	Oboe 2001	2	Sho	107 [B63]	Sho	4
E' Pan	044 [A64]	Echo Pan	2	Shaku'	108 [B64]	Shakuhachi	4
DrSolo	045 [A65]	Doctor Solo	2	Whis 1	109 [B65]	Whistle 1	2
S' daze	046 [A66]	Schooldaze	2	Whis 2	110 [B66]	Whistle 2	1
BISing	047 [A67]	Bell Singer	2	B' Blow	111 [B67]	Bottle Blow	4
Square	048 [A68]	Square Wave	2	B' Pipe	112 [B68]	Breath Pipe	3
Str S1	049 [A71]	Strings Section 1	4	Timps	113 [B71]	Timpani	2
Str S2	050 [A72]	Strings Section 2	3	M. Tom	114 [B72]	Melodic Tom	1
Str S3	051 [A73]	Strings Section 3	2	DSnare	115 [B73]	Deep Snare	2
Pizzi	052 [A74]	Pizzicato	3	EPerc1	116 [B74]	Electric Perc 1	2
V' lin1	053 [A75]	Violin 1	3	EPerc2	117 [B75]	Electric Perc 2	2
V' lin2	054 [A76]	Violin 2	2	Taiko	118 [B76]	Taiko	3
Cello1	055 [A77]	Cello 1	3	T' Rim	119 [B77]	Taiko Rim-Shot	1
Cello2	056 [A78]	Cello 2	2	Cymbal	120 [B78]	Cymbal	2
C' Bass	057 [A81]	Contrabass	2	C' nets	121 [B81]	Castanets	2
Harp 1	058 [A82]	Harp 1	3	T' ngle	122 [B82]	Triangle	2
Harp 2	059 [A83]	Harp 2	2	Orchit	123 [B83]	Orchestra Hit	4
Gtr 1	060 [A84]	Guitar 1	2	Phone	124 [B84]	Telephone	1
Gtr 2	061 [A85]	Guitar 2	2	Birds	125 [B85]	Bird Tweet	1
E Gtr1	062 [A86]	Electric Guitar 1	4	1NoteJ	126 [B86]	One Note Jam	4
E Gtr2	063 [A87]	Electric Guitar 2	3	WaterB	127 [B87]	Water Bells	3
Sitar	064 [A88]	Sitar	4	J Tune	128 [B88]	Jungle Tune	4

SEQUENCER BLOCK

Function ...		Transmitted	Recognized	Remarks
Basic Channel	Default Changed	all ch x	all ch 1 - 16 each	not Basic ch
Mode	Default Messages Altered	Mode 3 OMNI OFF, POLY *****	x x	
Note Number	True Voice	0 - 127 *****	0 - 127 0 - 127	
Velocity	Note ON Note OFF	○ x 9n, v = 0	○ x	
After Touch	Key's Ch's	○ ○	* *	
Pitch Bender		○	*	
Control Change	0 - 121	○	*	
Prog Change	True #	○ *****	* (0 - 127)	
System Exclusive		○	*	
System Common	Song Pos Song Sel Tune	* x ○	○ (SYNC = EXT) x ○	
System Real Time	Clock Commands	* *	○ (SYNC = EXT) ○ (SYNC = EXT)	
Aux Message	Local ON/OFF All Notes OFF Active Sense Reset	○ ○ (123) ○ x	○ ○ (123 - 127) x x	
Notes	* 1 Can be set to ○ or x manually. * 2 When power is first applied, OMNI OFF, POLY ON are sent for all channels (1 - 16).			

Mode 1 : OMNI ON, POLY
Mode 3 : OMNI OFF, POLY

Mode 2 : OMNI ON, MONO
Mode 4 : OMNI OFF, MONO

○ : Yes
x : No

MEMO

Roland
MT-100
DIGITAL SEQUENCER
AND SOUND MODULE

OPERATION GUIDE

Thank you for purchasing the Roland Music Recorder MT-100.

The MT-100 is a compact, light-weight, yet high quality MIDI sequencer that adopts the latest digital technology. It can effectively be used with a MIDI equipped electronic piano, but can also be played alone using the built-in synthesized sound source. This guide book explains how to use the MT-100 with the optional "ism" Music Libraries. To learn further about the MT-100, please read the owner's manual carefully and thoroughly.

CONTENTS

What is the MT-100	2
Using the MT-100 Couldn't Be Simpler!	
1 Let's Setup the MT-100 (with the Roland Piano)	4
2 Let's Play the Pre-recorded QD/Load and Play	5
3 Let's Choose a Song/Pause Mark	7
4 Playing a Track/Track Mute	8
5 MIDI channel change operation for the Roland piano	9
6 Choosing sounds of the MT-100	10
7 Let's Record	11
8 Saving Performance Data	12
What is the "ism" Music Library	13

What is the MT-100

The Roland MT-100, Digital Sequencer and Sound Module consists of two sections; sequencer and sound module sections.

A sequencer records performance data (what kind of melody, how strong, etc) and sends it to a sound module (or musical instrument), playing back the recorded data on the sound module, while a sound module stores various sounds (voices).

These two completely different devices, a sequencer and a sound module, need each other to be activated. In other words, a sound module is needed to play a sequencer, and a sequencer (or what is equivalent) is used for playing a sound module.

The MT-100 features a compact sequencer with a matching sound module, relieving you from complicated setups and operation.

What is a Sequencer?

The Roland MT-100 is so called a "sequencer". A sequencer plays a musical instrument, in other words, a musical instrument is played with data sent from a sequencer.

A sequencer transmits messages that instruct how an electronic musical instrument is to be played, using an international language called MIDI (Musical Instrument Digital Interface). The MIDI messages are received or transmitted through the MIDI connectors provided on the rear of the unit. A sequencer, however, cannot compose or learn to compose music. It is necessary that you record performance data in the sequencer beforehand. For example, you may record the performance that you played on the Roland Piano into the sequencer. Then, you can hear the Roland Piano by playing back the recorded data.

These recording and playback functions are similar to a tape recorder's, but a sequencer is entirely different from a tape recorder in the following points.

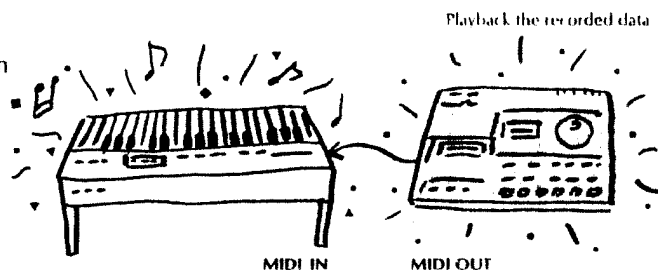
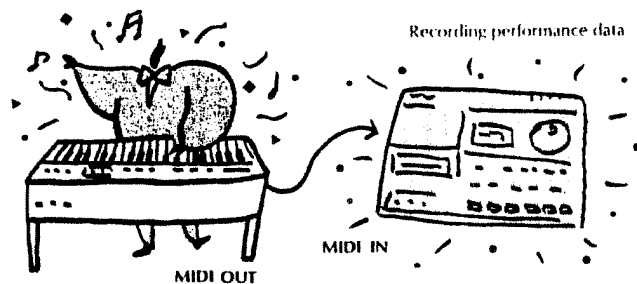
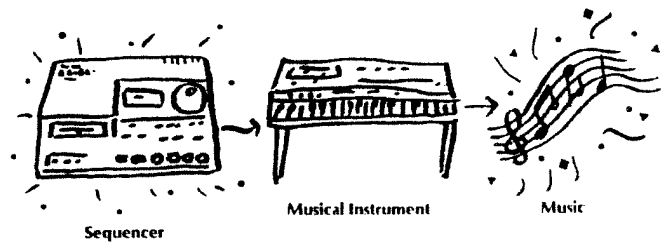

What Is the MT-100

- A tape recorder records sound directly onto a tape, while a sequencer records performance data into a built-in computer memory. Therefore, the pitch of sound in a sequencer is stable, while on a tape recorder it is raised or lowered when changing the tape speed.
- Performance data recorded in a sequencer is erased when the unit is switched off. To retain the data, you must save it onto a disk (a QD for the MT-100). In this way, the saved data can be loaded back into the sequencer at any time.
- Overdubbing between tape recorders deteriorates the sound quality, while data transfer between the sequencer and a disk does not affect the sound quality in any way.
- A sequencer features various useful functions such as playing a part of data, editing a part of data, etc.

Although provided with all the above sophisticated functions, the MT-100 is very easy to use, almost as easy as a tape recorder.

What is QD

“QD” stands for Quick Disk which can store various types of data on the disk-shape magnetic sheet. Data on the MT-100 can be saved onto a QD for later use.

A QD can store performance data on both A and B sides. To save data on side A, insert the disk into the MT-100's disk drive with side A facing upward.

When data cannot be saved on one side, take out the QD, then reinsert it with the other side facing upward to save the rest of data.

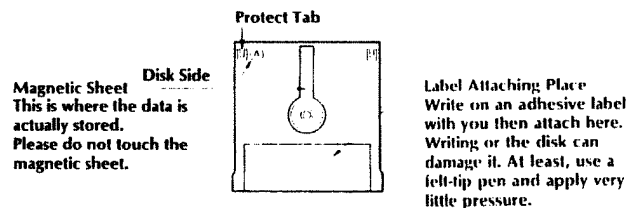

Protect Tab on the Disk

To protect the data saved on the disk from accidental loss, snap off the Protect Tab on the disk. This way, the disk can be no longer used for backup, but the data can be read from the disk just the same. The Tab is provided for each side, A and B.

If you wish to use the disk again for saving other data, stick a cellophane adhesive tape as shown below.

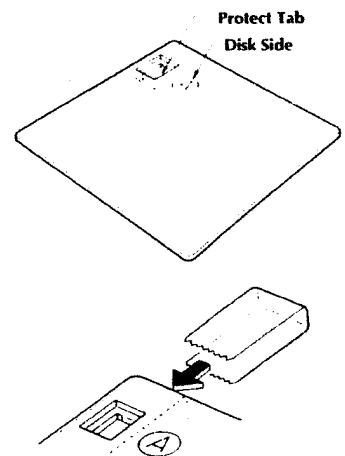

1 Let's Setup the MT-100 (with the Roland Piano)

Before setting up the MT-100 with the Roland Piano, switch off both units.

1 Connect both AC cords to the AC sockets.

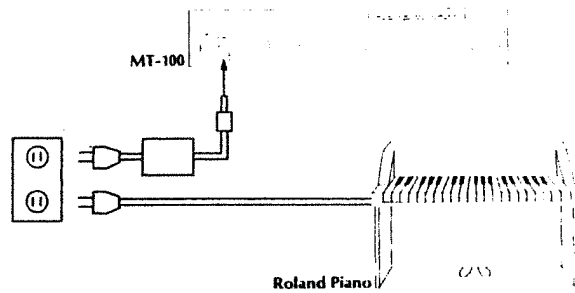

2 Connecting MIDI connectors.

Connect the MIDI OUT of the MT-100 to the MIDI IN of the Roland Piano.

Connect the MIDI IN of the MT-100 to the MIDI OUT of the Roland Piano.

*Be sure to use the specified MIDI cables for connecting the MIDI connectors.

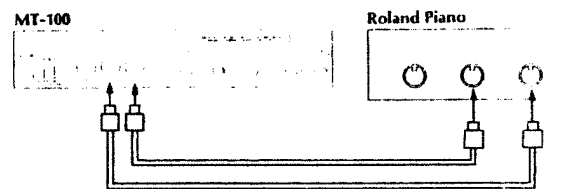

3 Connecting audio cables

Connect the output jacks on the MT-100 to the input jacks on the Roland Piano using the supplied audio cables (both L and R). If the Roland Piano features an input level selector switch, set it to the "H" position.

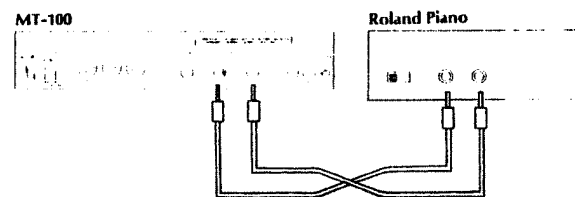

4 Set the Local Switch on the rear of the Roland Piano to OFF.



5 When all the connections are made, be sure to switch on the Roland Piano FIRST, THEN the MT-100.

Using the MT-100 Couldn't Be Simpler!

2 Let's Play the Pre-recorded QD/Load and Play

Now, let's play the data of the supplied QD. The optional "ism" Music Libraries (See page 13) can be played in just the same way.

The supplied QD contains performance data for demonstrating the excellent quality of the MT-100's built-in sound source.

Side A

	Title	Start Measure
1	Air On The G String	1
2	Liebesträume No. 3 (List)	48

Side B

	Title	Start Measure
1	The Nutcracker Overture Miniature	1
2	Czerny Technical Studies Op. 849 No. 1	120

- *All these tunes are selected from "ism" Music Libraries.
- *It is strictly forbidden to make copies except for your private use.

First of all, load the performance data on the QD into the MT-100.

1 Securely insert the QD into the disk drive on the MT-100 with the A side facing upwards.

2 Press LOAD.

The Display responds with "Load OK?".

Load OK?

3 Press QD-EXECUTE to load the performance data into the MT-100.

The Display responds with the message "Loading" for a short while, then a beep is heard when loading is completed.

Loading

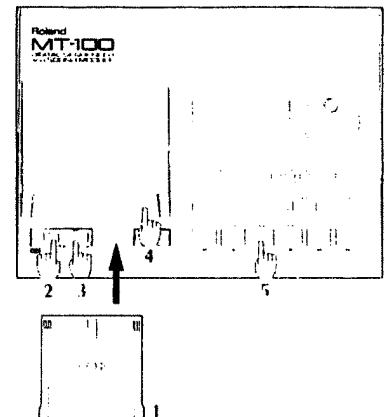

When data is stored using both the A and B sides, the Display shows the message "Change QD" when A side has been loaded. Here, press the Eject Button, remove the QD,(after "Insert QD" appears in the Display,) reinsert the disk with the B side facing upwards this time, the data is then automatically loaded into the MT-100.

4 Press the Eject Button to remove the QD.

5 Press PLAY to start playback.

- When a song is played back completely, the MT-100 will automatically stop. If you wish to stop playback in the middle of song, simply press STOP.
- During playback, the Display shows the current tempo and Measure (bar) number. To change the tempo, rotate the Alpha Dial.

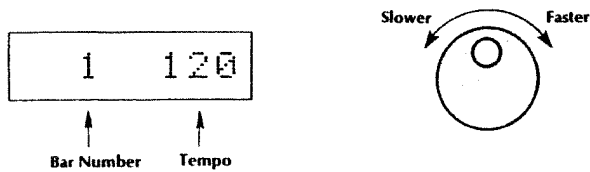

- To playback the song again, press RESET, then PLAY.

- *When a certain Music Library is being played back, the "FREE" is shown in place of tempo number in the display. This means that the song has been recorded without Metronome. Even in this case, the overall tempo can be changed (faster or slower).
- *You can rewind or forward some bars using BWD or FWD. (See "FWD/BWD" in the owner's manual.)
- *If you wish to playback part of a song repeatedly, use Markers A and B. (See "Marker" in the owner's manual.)

3 *Let's Choose a Song/Pause Mark*

A Pause Mark is written at the head of each song on the supplied QD or any Music Libraries. You can choose any song you wish by moving to the corresponding pause mark.

- To playback the next song, press FWD while holding STOP down.

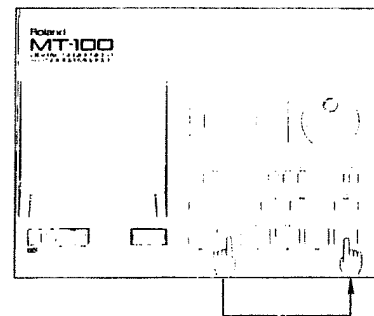

- To playback the previous song, press BWD while holding STOP down.
Doing this in the middle of a song will return the data to the head of the song.

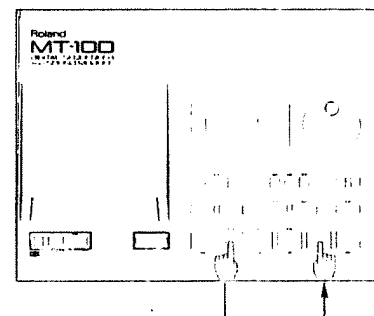

- When the MT-100 plays back data up to the next Pause Mark, it will automatically stop at that point. If you press PLAY here, the next song will be played back.

*The Pause Mark can be inserted or removed wherever you like. (See "Pause Mark" in the owner's manual.)

4 *Playing a Track/Track Mute*

The MT-100 features five Tracks where performance data is stored. You can mute any number of these five Tracks by using the Track Mute function.

Tracks 1 and 2 Record/Playback Tracks
Subtracks 3 and 4 Playback Tracks
Rhythm Track Rhythm Playback Track

Muting Track 1 or 2

Press 1 or 2 of the TRACK SELECT buttons 1 or 2. Each time you press the button, the indicator is turned on or off. When the indicator is not lit, the relevant Track is muted.

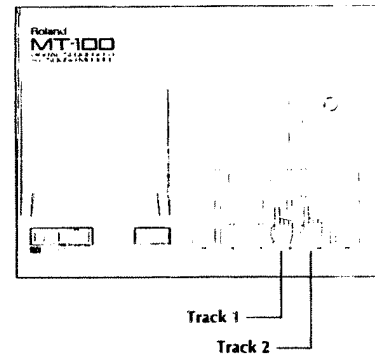

Muting Subtracks 3 or 4

While holding EXECUTE down, press TRACK SELECT button 1 (for Subtrack 3) or TRACKSELECT button 2 (for Subtrack 4). Each time you press the button, the indicator will be turned on or off. When the indicator is not lit, the relevant Track is muted.

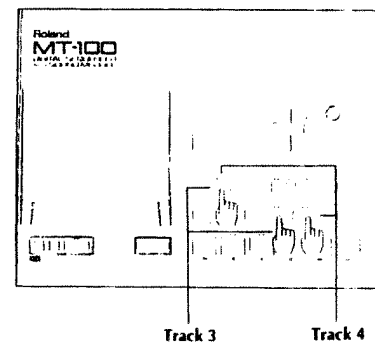

Muting the Rhythm Track

While holding EXECUTE down, press METRONOME. Each time you press the button, the indicator will be turned on or off. When the indicator is not lit, the Rhythm Track is muted.

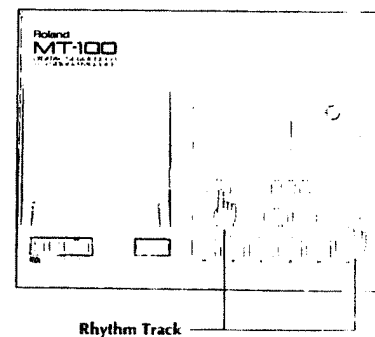

*Pressing the button will not light up the indicator of the Track if no data is recorded there.

5 MIDI channel change operation for the Roland piano

When the Roland piano's power is turned on, the MIDI channel is usually set to "Channel 1". Changing this MIDI channel will enable the sounds of the MT-100 to be played by the Roland piano. To do this:

1 Press the KEY TRANSPOSE/MIDI switch on the piano's panel.

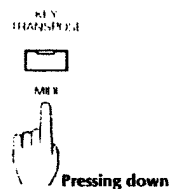

2 While pressing down the KEY TRANSPOSE/MIDI switch, press the key to select the MIDI channel. The key for changing to "Channel 2" is the second from the left. (F1 on a 76-key type Roland piano and A#0 for an 88-key type Roland piano.)

MIDI channels on a 76-note piano

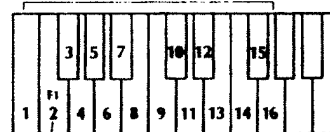

Channel 2

3 Play the Roland piano keyboard after turning down its volume. The piano will produce the synthesizer sound from the MT-100. Then adjust the volume of the MT-100.

MIDI channels on an 88-note piano



Channel 2

6 Choosing sounds of the MT-100

Next let's produce the MT-100's various built-in sounds. The MT-100 contains built-in sounds. It contains 128 different kinds of sounds ranging from strings such as the violin and cello, wind instruments such as the trumpet and saxophone, to pipe organ, bass, guitar, etc. To choose a sound:

- 1 Press **SOUND (TRACK SELECT 2)** button while keeping **SOUND-CONTROL** button pressed.

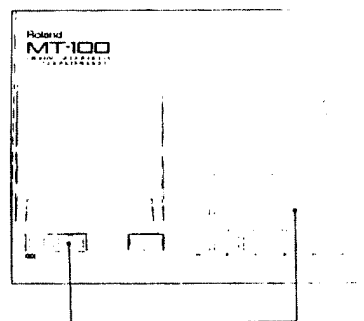
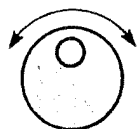
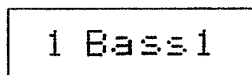

- 2 Rotate the **Alpha Dial** to change the sound (1 — 128).
- 3 Once you've mastered the steps above, you can change sounds of the MT-100 while playing the keyboard of the piano.
- 4 Press **EXECUTE** button to set the sound in the sound module.
or
Press **STOP** button to cancel.

*The following table illustrates the relationship between each part and the channels. You can use the different instrument sounds in all parts contained in the MT-100 by changing the MIDI channel.

MIDI Channel	2	3	4	5	6	7	8	9	10
MT-100 part	1	2	3	4	5	6	7	8	RHYTHM

7 *Let's Record*

Now, let's record your performance. Track 1 or 2 can be used for recording. Recording new data will erase any previous data written in the Track.

1 Press STOP + BWD or RESET (if it is the first song) to return to the head of the song.

2 If you wish to use the metronome, switch on METRONOME (the indicator will light). To change the tempo of the METRONOME, rotate the Alpha Dial.

3 Press REC.

4 Assign the Track where the recorded data is to be written, using the relevant TRACK SELECT buttons (1 or 2).

5 Start recording.

There are three different methods to start recording:

- Simply play the keyboard. Recording starts the moment you play the keyboard.
- Pressing PLAY plays two previous measures, then starts recording after these two measures.
- Press PLAY while holding EXECUTE down, recording starts after two measures of metronome, whether the Metronome Switch is on or off.

6 When you have finish playing, press STOP.

7 Press STOP + BWD or RESET (if it is the first song) to return to the head of the song, then press PLAY to playback what you have just recorded.

*To play a sound of the MT-100, set the MIDI channel of the Roland Piano to "Channel 2" (See page 9, 10.)

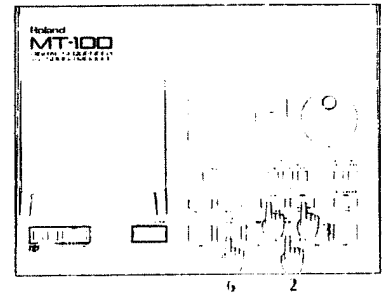

8 Saving Performance Data

The recorded data is retained in the MT-100 until it is switched off. To retain the data even after the unit is switched off, save it onto a QD.

1 Insert a QD into the MT-100. (If you use a QD which already has data stored, the data will be replaced with new data.)

2 Press SAVE.

The Display responds with "Save OK?"

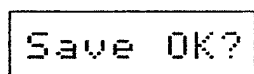

3 Press QD-EXECUTE.

The Display shows "Saving" for a while, then a beep is heard when saving is completed.

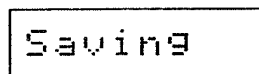

4 Press the Eject Button to remove the QD.

- You may write the content of data on the label for your reference.
- If you wish to keep the data permanently, snap off the protect tab on the QD.

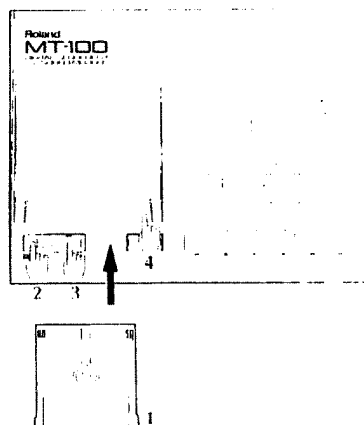

What is the “ism” Music Library

As well as your original performance data, optional “ism” Music Libraris (which have been released for the PR-100) can be used for playing musical instruments from the MT-100.

Piano Libraries

These Piano Libraries can be effectively used for piano lessons.

Piano Libraries include basic piano lesson pieces as follows:

Czerny 100 Progressive Studies Op. 139

Czerny 110 Easy and Progressive Exercises Op. 453

Czerny 30 Technical Studies Op. 849

Simply load the performance data in the libraries into the MT-100, and the corresponding piano music will automatically be played on your piano.

Ensemble Libraries

The Ensemble Libraries can be used for ensemble performance by an electronic piano, PR-100 and MT-32(Multi Timbral Sound Module). The MT-100 contains the PR-100's sequencer function and synthesized sound sources of the MT-32, therefore it can play ensemble performance alone using an Ensemble Library. The MT-100's sound source adopts Roland's LA sound system which has already been given high reputation by professional musicians. As being polyphonic, the MT-100 can perform small ensembles, bands and even large orchestrations.

Ensemble Libraries include:

Piano Concerto Collection such as the piano concertos of Beethoven and Grieg. Classical Master Piece Collections

You can play the piano to the orchestral performance of the above music. Also, many other well- known classical pieces of music are provided.

The Library continues to grow... and grow

The “ism” Music Library's variety of software is currently available for piano lessons; entertainment; educational purposes; background music; and sing-along hobby use. But it doesn't stop with the current assortment. Roland is committed to continuously expand the software to cover even more musical fields. Once you've experienced the immense musical potential of the software, you will make it a point to keep up with all the exciting new additions to the “ism” Music Library!



A HANDLING PROCEDURE FOR QD

When you want to remove the QD, please push the Eject Button.

If you try to take out the QD without pushing the Eject Button, the pad applied to the disk drive will be damaged, causing breakdown.

If the QD does not come out, push the Eject Button again.

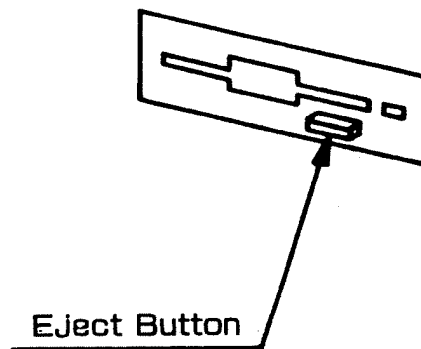

26015577 '88-11-AE2-11

«Recording»

● Key On Recording

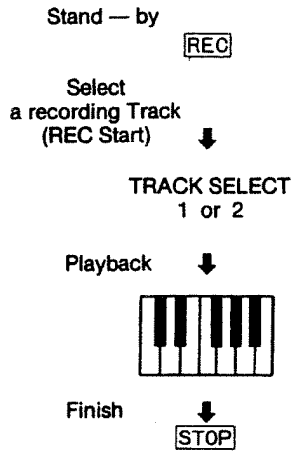

● Recording with metronome

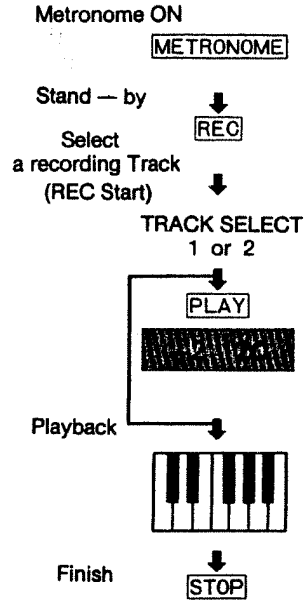

«Play»

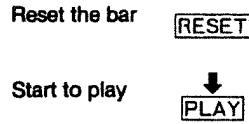

«Beat Setting»

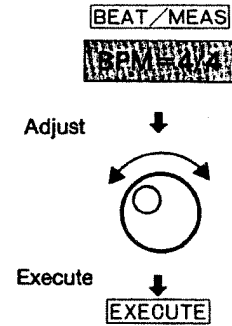

«Overdub»

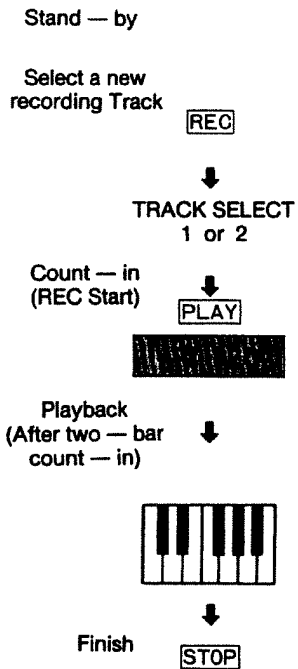

«Merge»

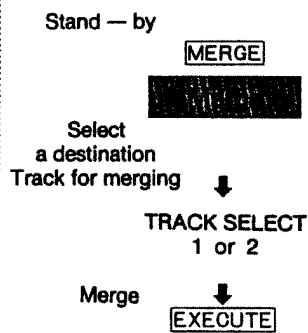

«Mute»

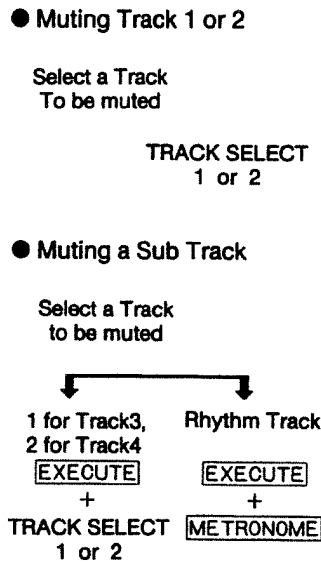

«Transpose»

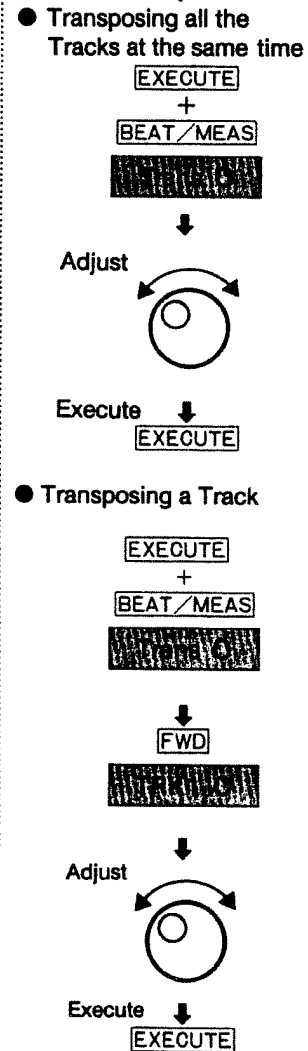

«Marker»

● Setting a Marker

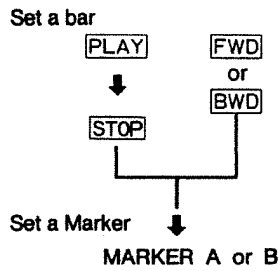

● Cancel the Marker

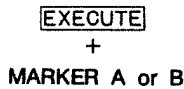

● Repeating A — B

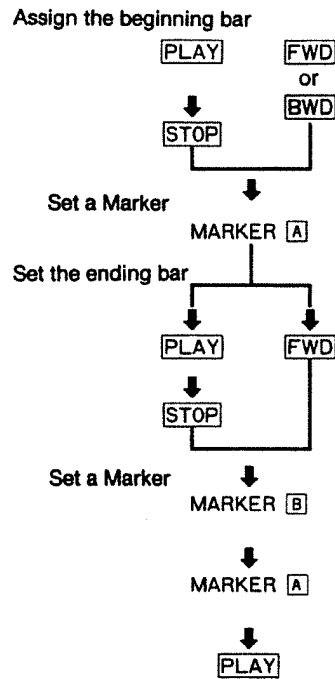

«Punch In/Punch Out»

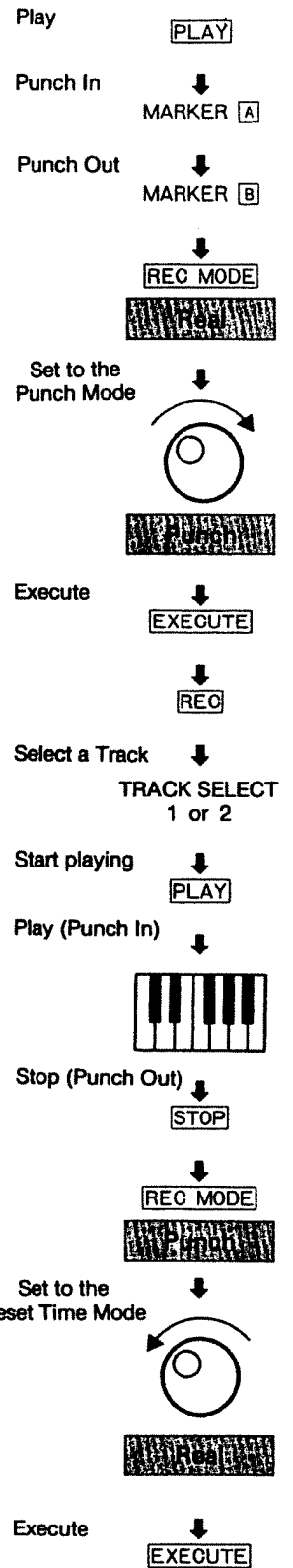

«Pause Mark»

● Setting a Pause Mark

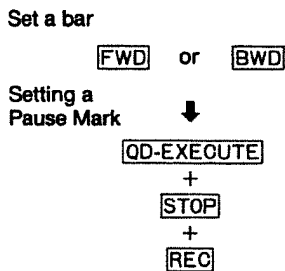

● Cancelling the Pause Mark

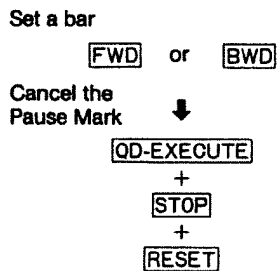

«Delete»

● Deleting a Track

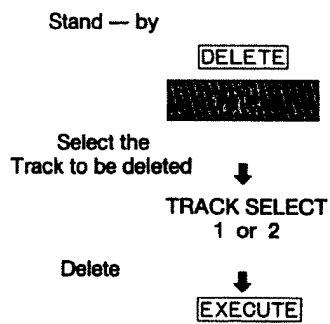

● Delete all the Tracks

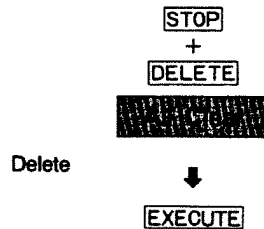

«Quantize»

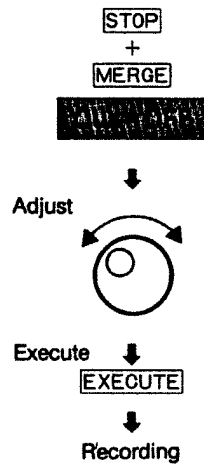

«Save»

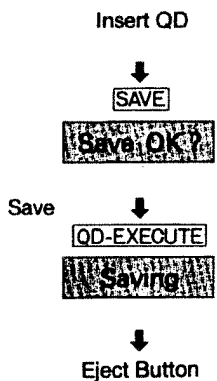

«Load»

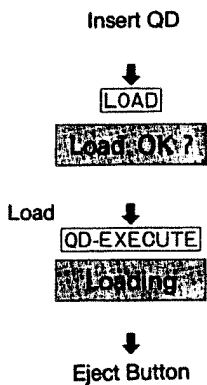

«Tone Selection»

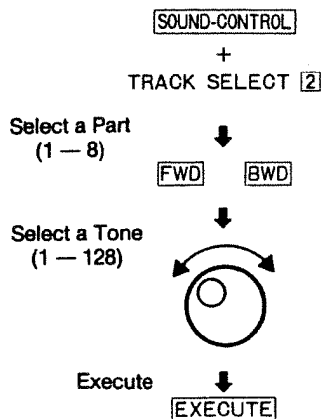

«Part Volume Adjustment»

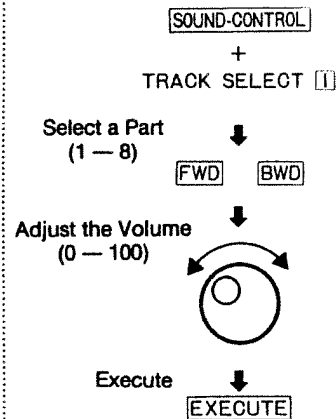

«Reverb Mode Selection»

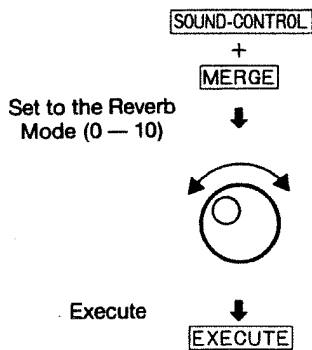

«Master Tuning»

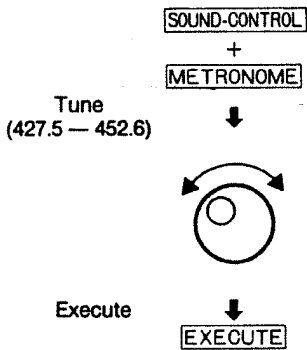

«Reset All Controllers»

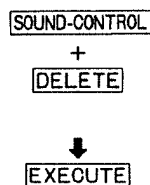

«Writing Sound Setting with Song Data»

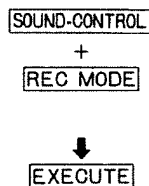

«ROM Play»

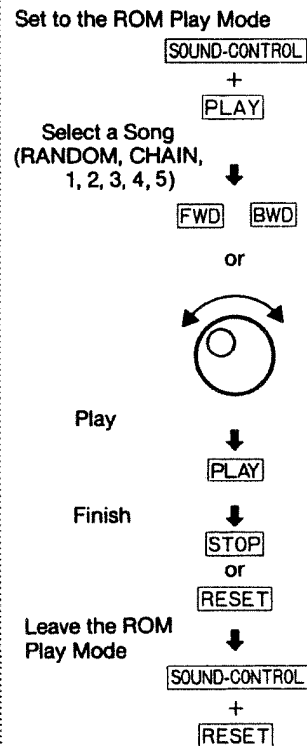

ERROR MESSAGES

ROLAND

▼ The MT—100 has broken down. Call for the Roland service station.



— MAIN MEMORY error



— MIDI CONFIGURATION MEMORY error

▼ Pushing the Stop Button will return the unit to the previous condition (which is before the Error Message is displayed).

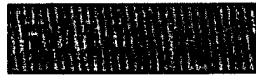

— Overloading the memory capacity in recording.



— The QD is totally blank.
— The QD was once used and loaded on other Roland products.
— The QD was once used and loaded on other manufacturers.
— Totally impossible for the Disk Drive to read because of the QD being damaged or faulty.



— Accurate saving is not possible.



— The Protect tab of the QD is broken off.



— Data in MT—100 does not correspond to data on QD when QD-Verify feature has been executed.



— In loading the data saved on both sides of a QD, and when the same side of the QD is inserted again or different QD is inserted.



— Impossible to save data onto the QD because of protection.



— QD is ejected, under loading or saving conditions.



— The QD is totally blank.
— The QD was once used and loaded on other Roland products.
— The QD was once used and loaded on other manufacturers.

Sound List

Prog.No. [HP:Prog] Used Partial
Tone name

PRESET TONE MAP

PIANO																							
001	[A11]	4	002	[A12]	2	003	[A13]	1	004	[A14]	3	005	[A15]	2	006	[A16]	2	007	[A17]	1	008	[A18]	3
Piano 1		Piano 2		Piano 3		E. Pno 1		E. Pno 2		E. Pno 3		E. Pno 4		E. Pno 3		E. Pno 4		E. Pno 4		H'tonk			
ORGAN																							
009	[A21]	3	010	[A22]	3	011	[A23]	2	012	[A24]	2	013	[A25]	3	014	[A26]	3	015	[A27]	2	016	[A28]	2
E. Org 1		E. Org 2		E. Org 3		E. Org 4		P. Org 1		P. Org 2		P. Org 3		P. Org 3		P. Org 3		P. Org 3		Accord			
KEYBRD																							
017	[A31]	4	018	[A32]	2	019	[A33]	1	020	[A34]	3	021	[A35]	2	022	[A36]	1	023	[A37]	4	024	[A38]	2
Hrpsi 1		Hrpsi 2		Hrpsi 3		Clavi 1		Clavi 2		Clavi 3		Clavi 3		Clavi 3		Cste 1		Cste 1		Cste 2			
S-BRASS																							
025	[A41]	2	026	[A42]	3	027	[A43]	2	028	[A44]	2	029	[A45]	2	030	[A46]	2	031	[A47]	2	032	[A48]	1
S. Brs 1		S. Brs 2		S. Brs 3		S. Brs 4		SynBs 1		SynBs 2		SynBs 3		SynBs 4		SynBs 4		SynBs 4		SynBs 4			
SYNTH 1																							
033	[A51]	3	034	[A52]	3	035	[A53]	3	036	[A54]	2	037	[A55]	4	038	[A56]	4	039	[A57]	4	040	[A58]	1
F'tasy		H'Pan		Choral		Glass		S'Trak		Atmos'		Warm B		FunVox		FunVox		FunVox		FunVox			
SYNTH 2																							
041	[A61]	3	042	[A62]	3	043	[A63]	2	044	[A64]	2	045	[A65]	2	046	[A66]	2	047	[A67]	2	048	[A68]	2
Echo B		Ice Rn		Ob 2001		E'Pan		DrSolo		S'daze		BiSing		Square		Square		Square		Square			
STRINGS																							
049	[A71]	4	050	[A72]	3	051	[A73]	2	052	[A74]	3	053	[A75]	3	054	[A76]	2	055	[A77]	3	056	[A78]	2
Str S1		Str S2		Str S3		Pizzi		V'lin 1		V'lin 2		Cello 1		Cello 2		Cello 2		Cello 2		Cello 2			
GUITAR																							
057	[A81]	2	058	[A82]	3	059	[A83]	2	060	[A84]	2	061	[A85]	2	062	[A86]	4	063	[A87]	3	064	[A88]	4
C'Bass		Harp 1		Harp 2		Gtr 1		Gtr 2		E Gtr 1		E Gtr 2		E Gtr 2		E Gtr 2		E Gtr 2		Sitar			

MT-100

Sound List



Prog.No. [HP-Prog] Used Partial
Tone name

PRESET TONE MAP

BASS											
065 [B11] 2	066 [B12] 1	067 [B13] 2	068 [B14] 1	069 [B15] 3	070 [B16] 2	071 [B17] 4	072 [B18] 2				
Bass 1	Bass 2	EBass 1	EBass 2	SlapB 1	SlapB 2	FretB 1	FretB 2				
WIND 1											
073 [B21] 4	074 [B22] 2	075 [B23] 3	076 [B24] 2	077 [B25] 2	078 [B26] 3	079 [B27] 4	080 [B28] 3				
Flute 1	Flute 2	Picc 1	Picc 2	Record	P Pipe	Sax 1	Sax 2				
WIND 2											
081 [B31] 2	082 [B32] 1	083 [B33] 3	084 [B34] 2	085 [B35] 2	086 [B36] 2	087 [B37] 2	088 [B38] 2				
Sax 3	Sax 4	Clari 1	Clari 2	Oboe	E Horn	B'soon	Hrm'ca				
BRASS											
089 [B41] 3	090 [B42] 2	091 [B43] 3	092 [B44] 2	093 [B45] 3	094 [B46] 2	095 [B47] 2	096 [B48] 4				
Trpt 1	Trpt 2	Trmb 1	Trmb 2	F Hrn 1	F Hrn 2	Tuba	Brs S1				
MALLET											
097 [B51] 3	098 [B52] 3	099 [B53] 2	100 [B54] 1	101 [B55] 3	102 [B56] 2	103 [B57] 4	104 [B58] 1				
Brs S2	Vibe 1	Vibe 2	SMalet	Wind B	Glock	Tube B	Xylo				
SPECIAL											
105 [B61] 3	106 [B62] 2	107 [B63] 4	108 [B64] 4	109 [B65] 2	110 [B66] 1	111 [B67] 4	112 [B68] 3				
M'imba	Koto	Sho	Shaku'	Whis 1	Whis 2	B'Blow	B'Pipe				
PERCUSN											
113 [B71] 2	114 [B72] 1	115 [B73] 2	116 [B74] 2	117 [B75] 2	118 [B76] 3	119 [B77] 1	120 [B78] 2				
Timps	M. Tom	DSnare	EPerc 1	EPerc 2	Taiko	T' Rim	Cymbal				
EFFECTS											
121 [B81] 2	122 [B82] 2	123 [B83] 4	124 [B84] 1	125 [B85] 1	126 [B86] 4	127 [B87] 3	128 [B88] 4				
C'nets	T'ngle	OrcHit	Phone	Birds	1 NoteJ	WaterB	J Tune				

 Roland®

79482039

UPC 79482039



10981

MT-100

 Roland

26025122

90-7-E2-81