



PRODESIGNER

I I S



IMPORTANT

Record your serial number below
for future reference:

The serial number (PROIIs-#####)
is located on the back of the board
by the metal bracket.

ProDesigner IIs

User's Manual



© 1993, Orchid Technology. This manual is copyrighted. All rights reserved. This document may not, in whole or part, be copied, reproduced, reduced or translated by any means, either mechanical or electronic, without prior consent in writing from Orchid Technology, Incorporated.

ProDesigner and Orchid are trademarks of Orchid Technology. All other products mentioned in this manual are trademarks of their respective manufacturers.

Orchid Technology
45365 Northport Loop West
Fremont, CA 94538-9973



TABLE OF CONTENTS

Foreword	v
Before You Begin	vi
Introduction	vii
CHAPTER 1	
Installing the ProDesigner IIs	1.1
Fig. 1.1: ProDesigner IIs Switch and Jumper Locations	1.2
Step 1: Preparing Your Computer	1.3
Fig. 1.2: PC Compatible Switch Block Location	1.3
Fig. 1.3: XT Compatible Switch Block Location	1.3
Fig. 1.4: IBM AT Monitor Switch Location	1.4
Step 2: Preparing Your ProDesigner IIs	1.4
Switch Settings	1.4
Fig. 1.5: ProDesigner IIs Switch Block	1.4
Switches 1 and 2: Monitor Refresh Rates	1.5
Fig. 1.6: SW1: OFF SW2: OFF	1.5
Fig. 1.7: SW1: ON SW2: OFF	1.5
Fig. 1.8: SW1: OFF SW2: ON	1.6
Fig. 1.9: SW1: ON SW2: ON	1.6
Table 1.1: Vertical Refresh Rate Settings	1.6
Switch 3: Translation ROM	1.7
Fig. 1.10: Switch 3: Translation ROM	1.7
Switch 4: Speed Booster Option	1.8
Fig. 1.11: Switch 4: Speed Booster Option	1.8
Jumper Settings	1.8
Fig. 1.12: Jumper Connector	1.8
Jumper JP1: IRQ2 Interrupt	1.9
Fig. 1.13: Jumper JP1 (pins 2 and 3 connected)	1.9
Fig. 1.14: Jumper JP1 (pins 1 and 2 connected)	1.9

Jumper JP2: Motherboard Compatibility Jumper	1.10
Table 1.2: Where to place JP2 jumper connector	1.10
Fig. 1.15: JP2 CMP Jumper Connections	1.10
Table 1.3: Switch and Jumper Settings	1.11
Step 3: Installing Your ProDesigner IIs	1.11
Fig. 1.16: Standard 15 pin D-shell VGA Connector	1.12

CHAPTER 2

Utility Software	2.1
XANSI.SYS Overview	2.1
SPEED_UP.SYS Overview	2.1
XMODE.COM Overview	2.1
DYNASCAN.COM Overview	2.1
ORCHDVSA.COM Overview	2.2
XEDIT.COM and XLOAD.COM Overview	2.2
ORCAI-16.EXE and ORCAI256.EXE Overview	2.2
Using XMODE	2.3
Fig. 2.1: XMODE Main Menu Screen	2.3
Using DYNASCAN.COM	2.5
Fig. 2.2 DYNASCAN Main Menu Screen	2.5
Using XANSI.SYS	2.6
Table 2.1: Extended Text Modes (Hex and Decimal)	2.6
Using SPEED_UP.SYS	2.7
Using ORCHDVSA.COM	2.7
Table 2.2: VESA BIOS Extension Modes	2.7
Using XEDIT.COM and XLOAD.COM	2.8
Using ORCAI -16.EXE and ORCAI256.EXE	2.9
Table 2.3: Orchid 8514/A Emulation Modes	

CHAPTER 3

Device Drivers	3.1
Before You Begin	3.1
Installation	3.2
Using PINSTALL.EXE	3.2
Fig. 3.1: PINSTALL Main Menu Screen	3.2
Network Considerations	3.3
Workstation Installation	3.3
Microsoft Windows Driver Installation	3.3
Fig. 3.2: ProDesigner IIs Setup Screen	3.4

CHAPTER 4

Technical Help and Information	4.1
Overview	4.1
Troubleshooting the ProDesigner IIs	4.2
ProDesigner IIs Technical Specifications	4.5
Additional Features:	4.6
Table 4.1: ProDesigner IIs Video Modes	4.7
How to obtain the Translation ROM	4.8
Fig. 4.1: Positioning ROM Chip	4.8
Fig. 4.2: ROM Chip Inserted	4.8
How to obtain the Memory Upgrade Kit	4.9
Fig. 4.3: ProDesigner IIs Memory Upgrade	4.9
How to obtain a RAMDAC Upgrade Kit	4.10
ET-4000 Technical Manual Available	4.10
Feature Connector Pin Outs (VESA Standard)	4.11
Fig. 4.4: ProDesigner IIs Feature Connector Location	4.11
Table 4.2: Feature Connector Pin Outs	4.11
FCC Notice	A.1
Index	I.1



Orchid Technology has been a leading manufacturer of hardware and peripherals for personal computers since its incorporation in 1982, and is noted for introducing new standards to the personal computer industry:

- 1982 **PCnet**: the first personal computer Local Area Network.
- 1984 **PCturbo**: the first Accelerator card for PC compatible computers.
- 1985 **ECCELL**: the first PC Multifunction card with error correction.
- 1987 **RamQuest 50/60**: the first EMS (Expanded Memory Specification) product for the IBM PS/2 computers.
- 1990 **ProDesigner II**: the first Beyond Super VGA graphics adapter to support 1024 x 768 graphics in 256 colors on interlaced and non-interlaced monitors.
- 1991 **ProDesigner II/MC**: the first graphics adapter to offer the advanced Beyond Super VGA features of the ProDesigner II for Micro Channel architecture.
- 1992 **Fahrenheit VA**: first to ship a Windows accelerator with video audio built-in.
- 1993 **Celsius/VLB**: first to ship a Windows accelerator based on IIT's AGX015 chip.

The ProDesigner IIs is the state of the art display adapter for 486, 386, 286 and PC compatibles. It combines incredible speed, flicker-free 72 Hz support, more colors (32,768 with 1MB and the Sierra HC RAMDAC chip installed) and truly high resolution graphics. It provides full VESA compliance and backward compatibility with VGA, EGA, CGA, HGC and MDA at an affordable price. That is why we call it Beyond Super VGA!

Thank you for buying the ProDesigner IIs. Care has been taken to ensure that it will provide you with years of trouble free operation. We believe you will be pleased with your purchase.



Before You Begin

This manual will familiarize you with the features, installation and use of the ProDesigner IIs. There are several symbols and conventions used throughout this manual which will help to draw your attention to a feature or to help you focus on important information:



When you see the Magnifying Glass it means the text is referring to something you should take a closer look at before proceeding further.

FILENAMES All MS/PC DOS filenames and DOS commands will be emphasized by this type style.

Common Names

MDA	Monochrome Display Adapter
HGC	Hercules Graphics Card
CGA	Color Graphics Adapter
EGA	Enhanced Graphics Adapter
VGA	Video Graphics Array
PC	Refers to the family of IBM PC, PC/XT or PC/AT compatible computers

INTRODUCTION

The ProDesigner IIs is designed to be the next generation VGA graphics adapter. Its technology features faster refresh rates (72 Hz) for flicker free operation, higher resolutions (up to 1024 x 768), more colors (32,768 with the Sierra HC RAMDAC chip installed) and more RAM, (up to 1 MB). The ProDesigner IIs maintains full compatibility with most monitor types (including Interlaced and Non-Interlaced monitors), and previous display standards, such as MDA, Hercules, CGA, EGA and VGA.

The ProDesigner IIs comes with a comprehensive range of software enhancements, including graphics drivers for Microsoft Windows 3.x, AutoCAD (along with the Orchid/Panacea DLD high speed Display List Driver), AutoShade and 3DStudio, Lotus 1-2-3, Ventura Publisher, WordStar, Wordperfect and the Orchid/Panacea RanaRender-VGA Plus driver.

The ProDesigner IIs utility programs include a special monitor refresh rate and video mode selector program, an extended ANSI.SYS driver, a custom font designer and loader, and a speed enhancement program.

The 16 bit ProDesigner IIs will operate in both the ISA (the IBM PC Industry Standard Architecture) and EISA (the new Extended Industry Standard Architecture) computer bus configurations. Its advanced circuitry will detect whether it is installed in an 8 or 16-bit bus computer and automatically adjust to 8 or 16-bit data transfer to ensure optimum performance and compatibility in various configurations.

The DB-15 (analog) output connector provides widespread support of interlaced and non-interlaced analog type monitors and with the optional Translation ROM installed, the ProDesigner IIs supports Monochrome, Hercules, CGA and EGA standards on fixed frequency (31.5 KHz) VGA monitors.

About This Manual

This manual presumes that you are already familiar with your IBM PC compatible computer. While the ProDesigner IIs has been designed to be easy to install, we recommend that you refer to your computer's reference manual when terminology or installation steps are unfamiliar to you.

This manual has been organized to help you set up and install the ProDesigner IIs as quickly as possible. Each section is divided into short, easy to follow steps, to help you understand the installation and function of the ProDesigner IIs.

Chapter 1: Installing the ProDesigner IIs

Whether you are a beginner or an experienced user, this chapter will give you important information on the proper installation of the ProDesigner IIs.

Chapter 2: Utility Software

This chapter will introduce you to the utility programs which are included with the ProDesigner IIs. These utilities will enhance the performance and capabilities of the ProDesigner IIs with many of your standard software programs.

Chapter 3: Device Drivers

Here you will be given the information needed to install high resolution device drivers for Microsoft Windows 3.x, AutoCAD ADI, Orchid/Panacea DLD (AutoCAD Display List Drivers), AutoShade, 3D Studio, Microsoft Windows 2.x, Lotus 1-2-3, Ventura Publisher, WordStar, WordPerfect and the Orchid/Panacea PanaRender-VGA Plus driver.

Chapter 4: Technical Help and Information

If you are experiencing installation difficulties or require troubleshooting information, this chapter will

give you checkpoints to look at to ensure that your ProDesigner IIs is operating properly. If these measures do not work, contact the nearest Orchid Technical Support department to receive prompt technical advice.

Chapter 4 includes information on how to upgrade your ProDesigner IIs. Orchid Technology offers several upgrades, including a RAM upgrade and an optional Translation ROM upgrade kit. Here you will also find information on obtaining the ET-4000 graphics chip technical manual and the ProDesigner IIs specifications and features.



INSTALLING THE PRODESIGNER IIS

The ProDesigner IIs was designed to be easy to use and easy to install. There are three basic steps to the installation:

Step 1: Preparing your Computer

You will need to take the cover off your computer, prepare an empty expansion slot for the ProDesigner IIs and, in some cases, set switches on your motherboard.

Step 2: Preparing your ProDesigner IIs

The ProDesigner IIs has one switch block and two jumpers that may need to be set for your system and monitor. These switch and jumper blocks have been preset to provide optimum performance and in most cases will not have to be set again. However, because there are many different PC configurations, they are provided to ensure that the ProDesigner IIs will work properly in your system.

Step 3: Installing your ProDesigner IIs

Once the computer and ProDesigner IIs have been prepared, the ProDesigner IIs will be installed into the computer, ready to operate.

Before you begin, you should have the proper tools handy. In most cases only a medium sized flat bladed screwdriver will be needed for this installation. Some computers may require other tools.

Warning!

Static Electricity is a deadly enemy of your computer peripherals.

Since you will be handling the ProDesigner IIs during this installation process, be sure to guard against electrostatic discharge. Do not wear clothing that causes static (such as wool sweaters) during the installation. In most cases touching the power supply housing will discharge static electricity. If you believe there may be a static problem you may want to buy a ground strap from your local radio parts store.

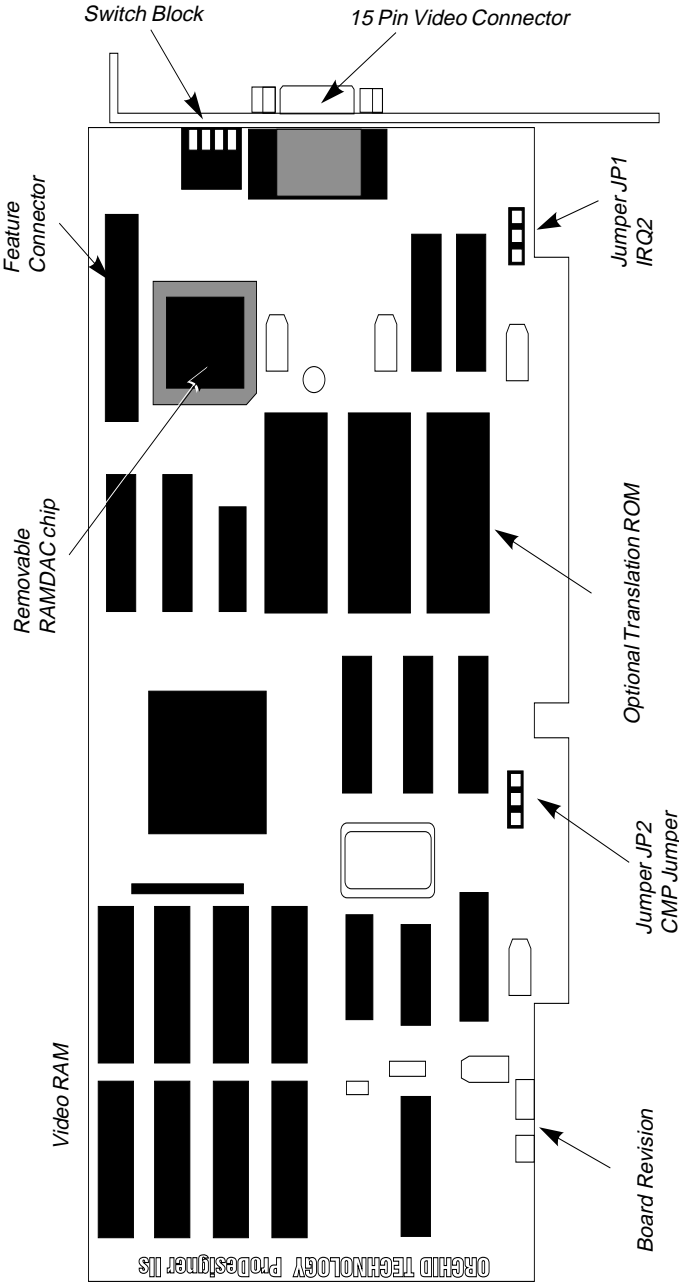

Figure 1.1: ProDesigner IIs Switch & Jumper Locations

■ Step 1 Preparing Your Computer

1. Make sure the power to your computer is turned off and that all of the necessary power cords and cables are disconnected from the computer.
2. Remove the screws that secure the computer chassis cover and slide the cover off (be sure to keep the screws in a safe place).
3. Set your motherboard switches:

PC Compatibles: There are two switch blocks on the motherboard (see figure below). Find switch block 1 and set switches 5 and 6 to ON:

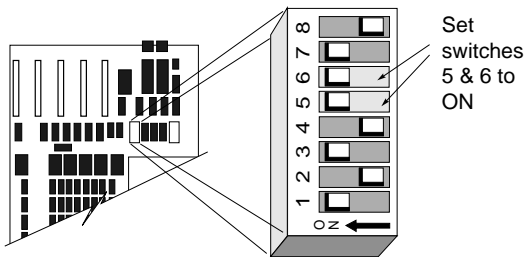

Figure 1.2: PC compatible switch block location

XT Compatibles: There is only one switch block on the motherboard. Set switches 5 and 6 to ON.

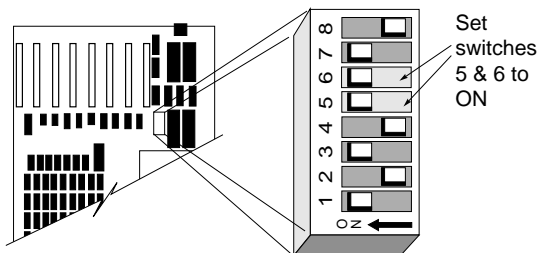
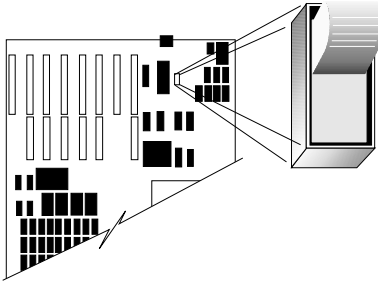

Figure 1.3: XT compatible switch block location

286/386 AT Compatibles: Some AT compatible motherboards have a small monitor switch to configure the system for color or monochrome displays. Slide the jumper towards the rear of the computer for *Color* displays.



Many 286/386 AT compatible motherboards do not have a switch or jumper block but instead rely on a setup program. In this case you will need to run the setup program after the ProDesigner IIs is installed.



This switch is set for a color display.

Figure 1.4 IBM AT monitor switch location

■ Step 2 Preparing Your ProDesigner IIs Switch Settings

The ProDesigner IIs has a small, four position, switch block located near the mounting bracket. These switches are pre-set to provide the best compatibility for most computer configurations and monitor types, but you should check these switches and ensure that they are configured correctly for your computer. The information on the following pages will assist you.

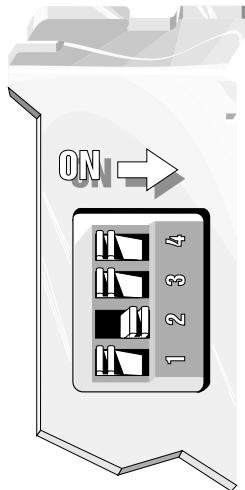

Figure 1.5: ProDesigner IIs switch block

Switches 1 & 2: Monitor Refresh Rates

Switches 1 and 2 may be set to configure the ProDesigner IIs to use different monitor vertical refresh rate settings for the 640x480, 800x600 and 1024x768 graphics modes. Some of the newer monitors support faster refresh rates - typically 70Hz or 72 Hz - which provide a more "flicker-free" display. Your monitor's reference booklet should provide you with the correct vertical refresh rate for your monitor.

SW1: OFF	SW2: OFF
Resolution	Refresh
640 x 480	60Hz
800 x 600	60Hz
1024 x 768	60Hz

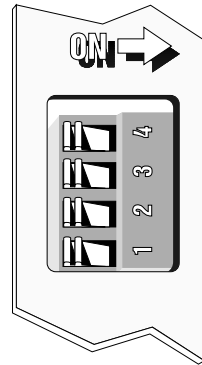

Figure 1.6: SW1: OFF SW2: OFF

SW1: ON	SW2: OFF
Resolution	Refresh
640 x 480	60Hz
800 x 600	56Hz
1024 x 768	45Hz

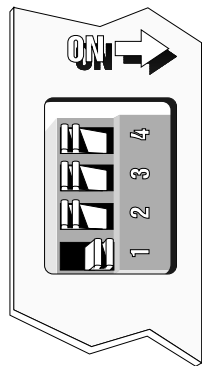

Figure 1.7: SW1: ON SW2: OFF

SW1: OFF SW2: ON

Resolution	Refresh
640 x 480	72Hz
800 x 600	72Hz
1024 x 768	60Hz

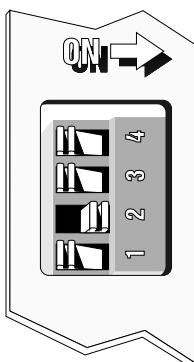

Figure 1.8: SW1: OFF SW2: ON



The Dynascan utility on your ProDesigner II Series Driver Disk will overwrite the monitor refresh rate switch settings. If you should change monitors, you can reset the refresh rates by using Dynascan.

SW1: ON SW2: ON

Resolution	Refresh
640 x 480	72Hz
800 x 600	72Hz
1024 x 768	70Hz

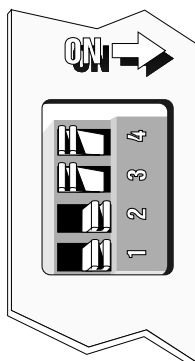

Figure 1.9: SW1: ON SW2: ON

Use the table below to help you to find the switch settings which best suit your monitor:

Switch Setting		Vertical Refresh Rates		
SW1	SW2	640 x 480	800 x 600	1024 x 768
✓ OFF	OFF	60Hz	60Hz	60Hz
ON	OFF	60Hz	56Hz	45Hz
OFF	ON	72Hz	72Hz	60Hz
ON	ON	72Hz	72Hz	70Hz
✓ Default setting				

Table 1.1: Vertical Refresh Rate Settings

Switch 3: Translation ROM

The ProDesigner IIs can support the previous IBM video standards, including Monochrome (MDA or HGC), Color Graphics Adapter (CGA) or Enhanced Graphics Adapter (EGA) when it is attached to the appropriate MDA, CGA or EGA monitor. If you need to run these modes on a standard VGA monitor (running at 31.5 KHz), you will need to install a Translation ROM.

If you do not have the optional Translation ROM installed leave SW3 in the OFF position. If you do have the Translation ROM, position SW3 to ON.

SW3: ON ROM Installed

SW3: OFF No ROM

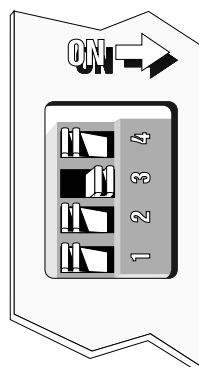

Figure 1.10: Switch 3: Translation ROM

The standard VGA monitor does not support these previous video standards (in either text or graphics modes) because it does not support their frequencies. However, when a Translation ROM is installed on a ProDesigner IIs the VGA monitor can run all of these modes, giving you full backward compatibility.

Many multi-frequency monitors already support the previous video frequencies and modes without the use of a Translation ROM. Before operating your multi-frequency monitor in one of these modes you should check your monitor for compatibility with the following frequencies: MDA and HGC (18.432 KHz), CGA (15.750 KHz) and EGA (21.850 KHz).

Switch 4: Speed Booster Option

The ProDesigner IIs can boost the speed of text and graphics operations 10-25% if switch 4 is set to ON.



The ET-4000 graphics chip used by the ProDesigner IIs is able to enhance its performance by setting its Bus access to zero wait states. This provides a direct increase in the speed of processing video information.

The Speed Booster option will work on any computer which permits peripheral cards to operate at zero wait states. Most computers will permit this, however, for those that don't, leave switch 4 in the OFF position. Please note that 8 Bit machines (PC and PC/XT compatibles) do not support zero wait state circuitry.

- SW4: ON** Enable Speed Booster
- SW4: OFF** Standard Speed

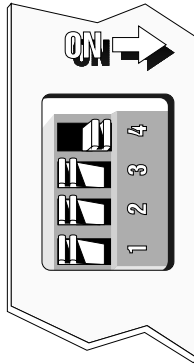
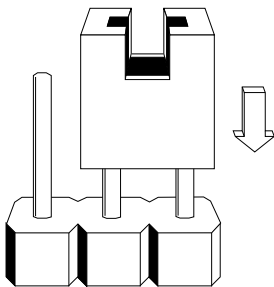

Figure 1.11: Switch 4: Speed Booster Option

Jumper Settings

There are 2 different jumper blocks that are used in the configuration of the ProDesigner IIs, located at JP1 and JP2. The next few pages will explain their use and proper settings. See figure 1.1 for the jumper locations.



Jumper blocks are configured by positioning a jumper connector over two pins on the jumper block. This creates a closed circuit across the two selected pins.

Figure 1.12: Jumper Connector

Jumper JP1: IRQ2 Interrupt

Jumper JP1 controls the use of the Vertical Interrupt. In its factory setting, the jumper connector is positioned on pins 2 and 3 of the jumper block, disabling IRQ2.



Some software and hardware require that IRQ2 be enabled. Please check your software or hardware reference manuals to determine if you must enable IRQ2.

Disable IRQ2

The figure on the right shows the jumper connector on pins 2 and 3 of jumper JP1, disabling IRQ2.

This is the default setting

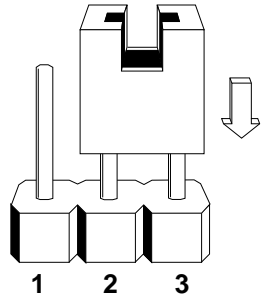

Figure 1.13: Jumper JP1 (pins 2 and 3 connected)

If you are using an application that requires Vertical Interrupt IRQ2 you can enable the interrupt by repositioning the jumper connector to pins 1 and 2 of JP1.

Enable IRQ2

Positioning the jumper connector on pins 1 and 2 of Jumper JP1 enables IRQ2.

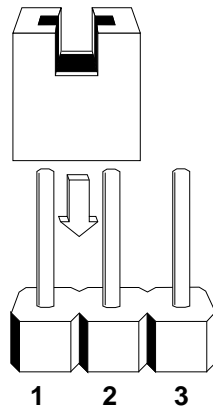

Figure 1.14: Jumper JP1 (pins 1 and 2 connected)

Jumper JP2: Motherboard Compatibility

The ProDesigner IIs has a motherboard compatibility jumper (labeled CMP) located at JP2, above the edge connector. The CMP Jumper enables the ProDesigner IIs to operate when installed in motherboards which use non-standard bus timing signals. Pins 2 and 3 are connected in the default position.

The following table will help you to determine where the switch should be positioned:

If this happens	...connect jumper pins
System does not boot	1 & 2
The sign-on message is scrambled at boot up	2 & 3
Graphics modes are scrambled in the software you are using	2 & 3

Table 1.2: Where to place the JP2 CMP Jumper Connector

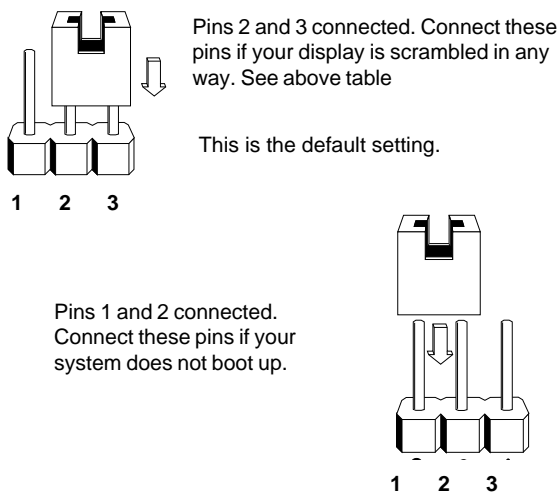

Figure 1.15: JP2 CMP Jumper Connections

Location	Setting	Default	Function
Switch Sw1 & SW2	See table on page 1.6		Sets Vertical Refresh rate for various monitor standards, including flicker-free, 72Hz support.
Switch SW3	ON OFF	✓	Translation ROM installed No Translation ROM installed
Switch SW4	ON OFF	✓	Enable Speed Booster Option Disable Speed Booster Option
Jumper JP1 IRQ2 Interrupt	Connect 1 & 2 Connect 2 & 3	✓	Enable IRQ2 Disable IRQ2
Jumper JP2 Compatibility	Connect 1 & 2 Connect 2 & 3	✓	If system locks up on boot up If video display is scrambled

Table 1.3: Switch and Jumper Settings

■ Step 3 Installing Your ProDesigner IIs

Once you are sure your motherboard and ProDesigner IIs switches and jumpers are set properly you are ready to install the ProDesigner IIs.

1. Find an empty expansion slot for the ProDesigner IIs. Be sure to check if any other video adapters in your system conflict with the video memory addressing of the ProDesigner IIs. If they do, either remove them from the system, or reconfigure their memory segment address.
2. Remove the rear slot cover bracket if it is present (keep the screw for future use).
3. Carefully hold the ProDesigner IIs by its top edges and lower it into its expansion slot. Ensure that the ProDesigner IIs seats firmly into the slot, and that it aligns properly with the computer's backplane.

4. Secure the ProDesigner IIs in place by fastening its metal bracket to the computer backplane (use the screw you removed in # 2).
5. Replace the cover of the computer along with the previously removed cables and power cords.
6. Connect your monitor cable to the 15 pin monitor connector on the ProDesigner IIs.

The ProDesigner IIs Installation is complete.

The ProDesigner IIs uses a standard 15 pin D-shell analog monitor connector. Your monitor may require a 9 to 15 pin adapter which can be purchased from your computer dealer. The pin-outs for the 15 pin VGA connector are below:

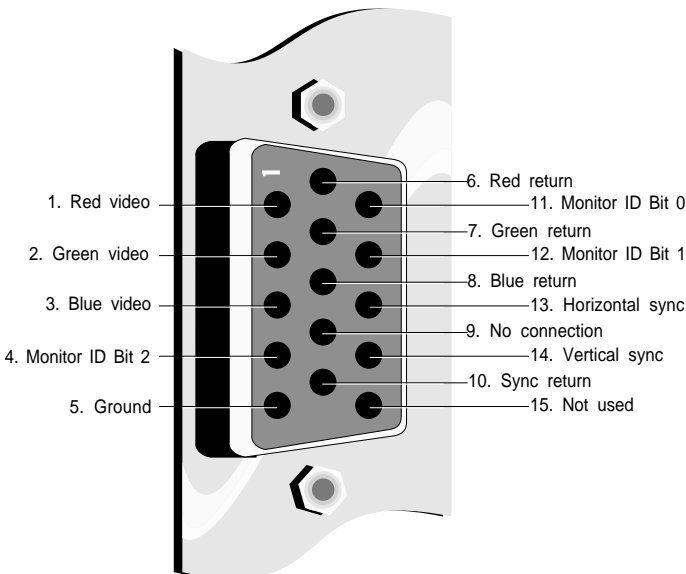

Figure 1.16: Standard 15 pin D-shell Connector

Chapter

2

UTILITY SOFTWARE

Your ProDesigner IIs is supplied with powerful utility programs. These programs can be used to enhance the performance of the ProDesigner IIs, and extend its capabilities. The ProDesigner IIs software utilities also included PINSTALL.EXE, an easy-to-follow, menu driven, installation program that will automatically PINSTALL the ProDesigner IIs device drivers and the utilities XANSI.SYS and SPEED_UP.SYS. Please see Chapter 3 for PINSTALL.EXE use and installation instructions.

XMODE.COM

XMODE.COM is a menu driven utility which will let you select one of the many ProDesigner IIs graphics or text modes.

DYNASCAN.COM

This program will help you configure your ProDesigner IIs to work better with your monitor by letting you select the refresh rates your monitor supports, even in the flicker-free, 72Hz modes.



Because it places the ProDesigner IIs BIOS into RAM, SPEED_UP uses 32 KB of memory when installed.

XANSI.SYS

XANSI.SYS is a device driver that allows you to use the extended text modes of ProDesigner IIs, allowing 25, 28, 30, 44 or 60 lines of text to be displayed on your screen. XANSI.SYS replaces the ANSI.SYS device driver that comes with your DOS operating system.

SPEED_UP.SYS

This RAM resident utility copies the ProDesigner IIs BIOS into high speed, system RAM. It can greatly increase the performance of software programs which call the video BIOS for screen updates.

ORCHDVSA.COM

Support is provided for the new VESA (Video Electronics Standards Association) graphics modes by using the ORCHDVSA.COM driver. The VESA committee (of which Orchid Technology is a voting member) standardized on these modes to improve the compatibility of various software packages across more hardware platforms.

XEDIT.COM and XLOAD.COM

XEDIT is a font creation program which will let you customize your own ProDesigner IIs fonts. XLOAD will load your newly designed fonts.

ORCAI- 16.EXE and ORCAI256.EXE

The ProDesigner IIs can emulate the IBM 8514/A in certain software applications by using the ORCAI-16.EXE and ORCAI256.EXE programs.

The installation and use of the ProDesigner IIs Utility programs are described in more detail on the following pages.

The instructions that follow assume that you are using a floppy drive, designated as Drive A:, and a hard drive, designated as Drive C:. Please substitute the correct drive letter if your computer is configured differently. Commands that are entered at the DOS prompt will designate the default drive letter and DOS prompt as follows:

A:\XMODE



Type only the command or program name. Do not type in the Drive letter or the DOS prompt. Instructions which designate certain keys to press will use graphic key representations as in the above example.

■ Using XMODE

XMODE is a menu-driven program to help you select the ProDesigner IIs video modes which are available for your configuration. With a few simple keystrokes you can switch your ProDesigner IIs into one of the many extended high resolution modes listed. In addition, your ProDesigner IIs supports the hardware emulation of the old video standards: MDA, CGA, HGC and EGA. Certain programs, such as games, may be written specifically to run in CGA, HGC or EGA mode. By using XMODE, the ProDesigner IIs will perform the hardware emulation necessary for these video modes to run correctly.

To use XMODE you will first need to copy XMODE.COM from the ProDesigner IIs diskette to your hard drive.

XMODE.COM can be run directly from the DOS command line, or from a menu. There are three XMODE display screens available; the Menu screen, the Help screen and the Status screen.

1. The main Menu screen for XMODE will be displayed by typing:

C:\XMODE

Enter ↵

Orchid Technology
ProDesigner IIs XMODE Version 1.x

Emulation Modes: MDA HERC CGA EGA **UGA**

MUDEM	RES.	TYPE	COLOR	MUDEM	RES.	TYPE	COLOR
00	40x25	text	16	13	320x200	grfx	256
01	40x25	text	16	22	132x44	text	16
02	80x25	text	16	23	132x25	text	16
03	80x25	text	16	24	132x28	text	16
04	320x200	grfx	4	25	640x480	grfx	16
05	320x200	grfx	4	26	800x600	text	16
06	640x200	grfx	2	29	800x600	grfx	16
07	80x25	text	2	2A	100x40	text	16
08	320x200	grfx	16	2D	640x350	grfx	256
0E	640x200	grfx	16	2E	640x480	grfx	256
0F	640x350	grfx	MC	2F	640x400	grfx	256
10	640x350	grfx	16	30	800x600	grfx	256
11	640x480	grfx	2	37	1024x768	grfx	16
12	640x480	grfx	16	38	1024x768	grfx	256

F1 = Help F2 = Switch Definition F10 = Status
↑ Arrow Up ↓ Arrow Down ↔ Any Key ← Select

Figure 2.1: XMODE Main Menu Screen

2. The XMODE Help screen can be accessed from the XMODE menu or directly at the DOS command line by typing XMODE ? at the prompt:

```
C : \XMODE ?
```



3. The XMODE Status screen will let you take a quick look at present configuration of your ProDesigner IIs. XMODE Status can be accessed from the menu, or from the DOS command line by typing:

```
C : \XMODE STATUS
```



4. Although the XMODE Menu screen is a useful tool, it can be cumbersome when you wish to change modes quickly. To switch to any of the ProDesigner IIs text or graphics modes from the command line, type:

```
C : \XMODE n
```



(n represents your selected mode number)

5. XMODE can also be used with the following parameters to switch modes at the command line:

```
C : \XMODE MDA
```

```
C : \XMODE HERC
```

```
C : \XMODE CGA
```

```
C : \XMODE EGA
```

```
C : \XMODE VGA
```



XMODE will choose the default text mode 3 when you select CGA, EGA, or VGA emulation, and default text mode 7 for MDA and Hercules.

You should not invoke XMODE with any of these parameters if you do not have a compatible monitor. If you are using a VGA monitor (or a multi-frequency monitor which supports the standard VGA frequency), you may use these parameters if you have the Translation ROM installed. With the optional Translation ROM, MDA, CGA, HGC and EGA modes can be displayed on monitors supporting the VGA fixed frequency (31.5 KHz) signal.

■ Using DYNASCAN.COM

The DYNASCAN.COM program will help you configure your monitor by letting you select the refresh rates your monitor supports for the 640x480, 800x600 and 1024x768 modes. You may run DYNASCAN.COM from the DOS prompt by typing:

```
C:\DYNASCAN -x c: 
```

Where -x= 'I' to Install, 'S' for Status, 'ON' or 'OFF'.

Your screen will display a list of video modes and monitor refresh rates, similar to the figure below:

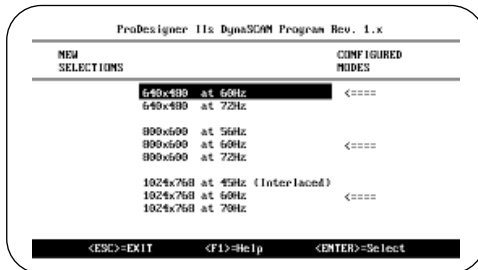

NEW SELECTIONS	CONFIGURED MODES
640x480 at 60Hz	<====
640x480 at 72Hz	
800x600 at 56Hz	
800x600 at 60Hz	<====
800x600 at 72Hz	
1024x768 at 45Hz (Interlaced)	
1024x768 at 60Hz	<====
1024x768 at 78Hz	

<ESC>=EXIT <F1>=Help <ENTER>=Select

Figure 2.2: DYNASCAN Main Menu Screen

The modes which are available to you are listed down the center of the screen. The arrows in the right column indicate your current configuration, while the arrows on the left indicate new choices made during this session.

After selecting a video mode, a box will be drawn around the perimeter of the screen. Center this box on the screen with the arrow keys and press Enter to select your setting (Esc will exit to the menu).

Your newly selected modes will be pointed to by an arrow in the left column under New Selections. When you exit DYNASCAN.COM, the ProDesigner IIs will use your new settings. They will remain active until you either set the ProDesigner IIs hardware switches (SW1 and SW2) to support another refresh rate, or until you run DYNASCAN.COM again.

■ Using XANSI.SYS

XANSI.SYS is a direct replacement for the standard DOS ANSI.SYS driver. As part of your CONFIG.SYS file, it is loaded when you boot up your computer. To use XANSI.SYS, add the following line to your CONFIG.SYS file:

```
DEVICE = C:\XANSI.SYS
```

Although all of the standard ANSI commands are the same, XANSI.SYS supports the extended text modes of the ProDesigner IIs. For example, the following line, entered at the DOS prompt, sets the ProDesigner IIs into 132 column x 25 line text mode:

```
C:\>Prompt $e[=35h $p$g 
```

To reset to standard text mode enter:

```
C:\>Prompt $e[=03h $p$g 
```

In this example, we set the video mode to an extended ProDesigner IIs text mode, not supported by the standard DOS ANSI.SYS. Using the standard DOS PROMPT function, we passed the decimal equivalent of ProDesigner IIs extended text mode 23 (actually 23 hex converted to 35 decimal), along with the ANSI command “h” to set the mode. To use other extended ProDesigner IIs text modes in the example, use the table below (or see the table in chapter 4):

Text Mode (Hex)	Text Mode (Decimal)	Resolution
00	00	40 x 25
03	03	80 x 25 (color)
07	07	80 x 25 (mono)
22	34	132 x 44
23	35	132 x 25
24	36	132 x 28
26	38	80 x 60
2A	42	100 x 40

Table 2.1: Extended Text Modes (Hex and Decimal)



XANSI.SYS can also be installed using the utility PINSTALL.EXE. See page 3.2.

■ Using SPEED_UP.SYS



SPEED_UP.SYS can also be installed using the utility PINSTALL.EXE. See page 3.2.

SPEED_UP.SYS will copy the ProDesigner IIs BIOS into high-speed system RAM, thereby greatly increasing on screen performance with software which uses the video BIOS for screen updates. To use the SPEED_UP.SYS driver, enter the following line in your CONFIG.SYS file:

```
DEVICE = C:\PROIIS\SPEED_UP.SYS
```

You will not need to use SPEED_UP.SYS on those computers which use shadow RAM. Using both may cause incorrect operation of either.

■ Using ORCHDVSA.COM

The ProDesigner IIs supports the VESA (Video Electronics Standards Association) graphics modes by using the ORCHDVSA.COM driver. To use ORCHDVSA.COM, copy it to your working directory (preferably one in your DOS PATH) and invoke it from the DOS prompt:

```
C:\>ORCHDVSA 
```

The VESA extension is now loaded and will support the following modes:

Resolution	VESA Mode	Video Memory Required
640 x 400 x 256	100h	256 KB
640 x 480 x 256	101h	512 KB
800 x 600 x 16	102h or 6Ah	256 KB
800 x 600 x 256	103h	512 KB
1024 x 768 x 16	104h	512 KB
1024 x 768 x 256	105h	1024 KB

Table 2.2: VESA BIOS Extension Modes

The VESA graphics modes improve the overall compatibility of the ProDesigner IIs with software which supports the new VESA standard. Since the VESA

graphic modes standardize the way software looks at Super VGA hardware, more software companies will recognize this standard and offer VESA compatibility in their graphics installation options. The direct benefit is that you will have more software supporting the advanced features of the ProDesigner IIs.

■ XEDIT.COM and XLOAD.COM

XEDIT is a special font creation program which will let you modify and create your own ProDesigner IIs fonts. XLOAD will load your newly designed fonts.

To use XEDIT, you will need to expand and copy all the font files from the ProDesigner II Serier diskette to a directory of your choice. To execute the copy and unarchive function, insert your drivers disk into drive A: and type:

```
A:FONT.EXE -0 C:\<PATH> 
```

where <PATH> indicates the directory of your choice.

To use XEDIT, at the DOS prompt type:

```
C:\XEDIT fontfile.fnt 
```

Where "fontfile.fnt" is the name of the font file you wish to edit.

If the optional parameter is not used you will be able to select an existing font file from a list as a model for your new font. After making your selection, the XEDIT screen will display a table of ASCII characters and a character editing box. Follow the on screen directions (press F1 for Help) to select and edit your characters, then save your font file.

You can load your new font file from the DOS prompt by using XLOAD.COM.

To use XLOAD, at the DOS prompt type:

C:\XLOAD fontfile.fnt 

Where "fontfile.fnt" is the name of your saved font file.

The character sets which you create can be used to enhance any standard DOS text based program which does not reset screen parameters when run.

■ ORCAI-16.EXE and ORCAI256.EXE

The ProDesigner IIs can emulate the IBM 8514/A standard through the use of special software supplied on the ProDesigner II Series Disk in the \8514 directory. To use the 8514/A emulation program, you will need to unarchive and copy all the files from the \8514 subdirectory to a directory of your choice on your hard drive. To execute the copy and unarchive function, type at the A: prompt:

A:\8514.EXE -O C:\<PATH>

where <PATH> indicates the directory of your choice.

After doing so, decide which graphics mode you want to run your 8514 software in, and use the appropriate program as given in the table below:

Resolution	Colors	Mode (hex) Required	Video Memory	Driver
640 x 480	16	12	512 KB	ORCAI-16.EXE
640 x 480	256	2E	512 KB	ORCAI256.EXE
1024 x 768	16	37	512 KB	ORCAI-16.EXE
1024 x 768	256	38	1024 KB	ORCAI256.EXE

Table 2.3: Orchid 8514/A Emulation Modes

Once you have chosen the correct 8514/A emulation program to run, enter it at the DOS prompt, BEFORE you run your 8514/A supported software. For instance, to emulate 8514/A in 256 color mode, type:

C:\ORCAI256



This loads the ORCAI256 driver into memory, ready to emulate the 8514/A. Now you can run your 8514/ software application.

Because these drivers “emulate” the 8514/A, you may find some programs which support the IBM 8514/A standard that will not work. Those software programs were written to work directly with the 8514 graphics hardware. The ProDesigner IIs does not use the expensive 8514 co-processor or hardware circuitry to generate high resolution modes (e.g. 1024 x 768 with 256 colors), hence programs written for specific 8514 hardware will not work properly, and an incompatibility arises.

Chapter

3

DEVICE DRIVERS

To take advantage of the advanced features of the ProDesigner IIs, high resolution drivers for popular software applications are provided on the driver diskettes. Follow the appropriate installation instructions for each application.

Your ProDesigner IIs is register-level compatible with MDA, CGA, EGA, HGC, and VGA modes. Most software programs can be operated in any of these modes using drivers supplied by the software manufacturer.

The high resolution drivers include the following:

Microsoft Windows 3.1
AutoCAD 10, 11, 12
AutoShade
Lotus 1-2-3
Ventura Publisher
WordPerfect
WordStar
3D Studio

Also included is MasterCAD, a PADI (Protected Mode AutoDesk Driver Interface) driver for AutoCAD, AutoShade and 3D Studio. Some of the features of MasterCAD include Birds-Eye View and Edge-Pan.

Drivers for Gem Desktop, SCO Unix, OS/2 and Microsoft Windows 286/386 are available through the Orchid Technical Support Department, or, may be downloaded from the Orchid BBS.

Before You Begin

Before installing any of the ProDesigner IIs high resolution drivers, verify the capabilities of your monitor. If you PINSTALL drivers for a resolution that your monitor is not capable of producing, the results will probably be unsatisfactory.



Some software programs may already include software drivers for the ProDesigner IIs, check with the manufacturer for verification.



See the Help feature of the PINSTALL utility program for a list of Orchid telephone numbers.

Using PINSTALL.EXE

You must have an application installed on your computer before you can install the ProDesigner II Series software drivers for that application.

PIINSTALL.EXE is an easy to use menu driven program which will allow you to automatically PINSTALL the ProDesigner II Series software drivers and the utilities SPEED_UP.SYS and XANSI.SYS. Invoke the PINSTALL.EXE from the DOS prompt by typing:

A : \PIINSTALL 

You will be prompted to press <ESC> to EXIT or <ENTER> to continue through the PINSTALL.EXE program. Upon selecting <ENTER> the Main Menu will appear:

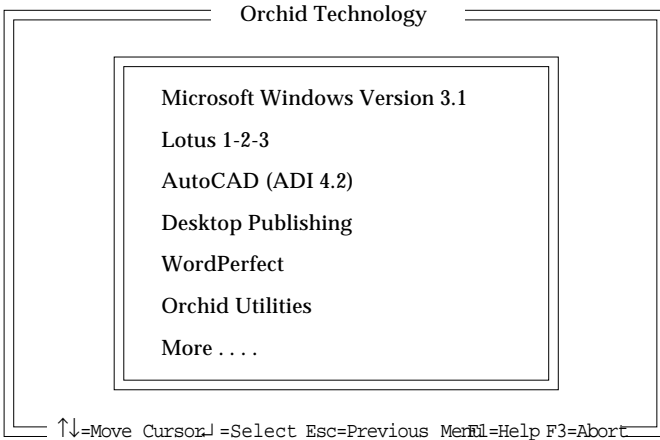

Figure 3.1: PINSTALL Main Menu Screen

From the Main Menu highlight the driver to be installed by using the <↑↓> arrow keys and press <ENTER> to select. Proceed through the installation as prompted by the PINSTALL.EXE program. Repeat this process for all of the drivers and utilities you wish to use with the ProDesigner II Series.



The PROII directory is created upon running the PINSTALL.EXE utility located on your ProDesigner II Series Driver Disk.



For assistance during the installation process, PINSTALL.EXE provides on-line help by selecting the F1 key at any time.

Network Considerations

The PINSTALL installation program offers standard and network server installation options for Windows drivers. If you are using Windows on a Novell (or compatible) network, you will need to install the ProDesigner II Series Windows drivers to the Shared Windows directory on the network server. You should select the network server installation option. Once the drivers are installed on the network server, the Orchid icon will appear in the Windows Control Panel on the workstation(s) for individual driver customization on each workstation.



You may need to run Windows Setup from the DOS prompt to change your video driver to the default VGA driver, if you had another manufacturer's video card installed previously.



To see the Setup utility version # and the amount of video memory installed, click on the control menu box in the upper-left corner of the dialog box.

Workstation Installation

After installation of the Orchid drivers using the PINSTALL program, follow the step below:

1. Copy the PDSETUP.ORB file from your network shared directory to your local workstation Windows directory.

Microsoft Windows Driver Installation

Once you select the Microsoft Windows installation, the PINSTALL program automatically copies the Windows 3.1 driver (HyperDriver) and the ProDesigner II Series Setup utility to your hard drive.

Follow the instructions below:

To configure the Orchid HyperDriver:

1. Start the Microsoft Windows application.
2. Double-click on the Control Panel icon (usually located in the Main group on the Windows desktop). From the Control Panel window, double-click on the ProDesigner IIs Setup icon. The following menu will appear:

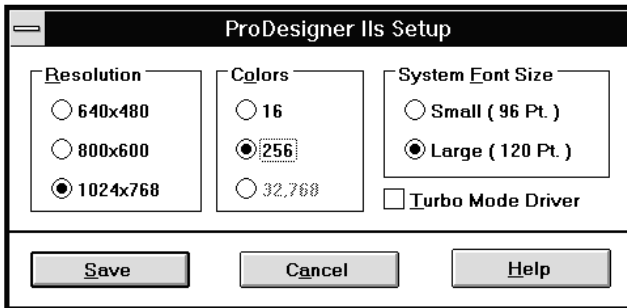

Figure 3.2: ProDesigner IIs Setup Screen

This easy-to-use utility will allow you to configure the following:

- Choose the desired color, resolution and menu text font size (96 or 120 DPI) for your Windows driver.
- Select the Turbo Mode Driver, which enables turbo mode for the 256K color modes only. The ProDesigner IIs standard driver will support 16K, 256K and 32K color modes.

If a problem occurs while in Turbo Mode, switch back to standard mode by un-checking the Turbo Mode box.

3. Make your desired selections and restart Windows for all configurations and changes to take effect. Use this utility now and for any future changes to the ProDesigner IIs video display.

You are now ready to use the graphics capabilities of the ProDesigner IIs.

For details on using the other PINSTALL menu options, press the F1 key at any time for on-line help.

4

■ TECHNICAL HELP AND INFORMATION

Orchid Technology is known for its responsiveness to its customers. This chapter will explain how you can get extra help when you need it, as well as give you helpful troubleshooting hints and technical specifications for the ProDesigner IIs.

This chapter is divided up into two parts:

Troubleshooting the ProDesigner IIs

This is a quick guide to get you up and running when something goes wrong. It will provide you with all kinds of tips and facts about the ProDesigner IIs to help get started.

ProDesigner IIs Technical Specifications

The features and specifications of the ProDesigner IIs are covered in this chapter. Included are the Video Modes supported by the ProDesigner IIs, and information on how to purchase the optional Translation ROM or the ET-4000 Technical Manual, as well information on the VESA compatible Feature Connector.

■ Troubleshooting the ProDesigner IIs

The following information will help you diagnose problems you may have with the ProDesigner IIs.

Following these simple steps serves a two-fold purpose:

You may be able to fix your problem and avoid having to contact the Orchid Technology Technical Support Department...

or

if these steps do not help you solve your problem, they will most certainly give you a better handle on what to tell the Technical Support Analysts once you do contact them.

The information provided here is in symptom/response form. That is, a symptom will be given, and a check point response is provided for you to look at.

Symptom 1 *The computer does not power-up, or respond when powered on. The screen is completely blank. There is no familiar boot up (POST test) beep.*

- Check**
1. Is the ProDesigner IIs properly installed in the slot? Is the edge connector inserted all the way into the expansion slot? Is the ProDesigner IIs properly aligned with the motherboard's backplane?
 2. Is there another display adapter in your system that may be using the same memory addressing? If so, change its addressing or remove it from the system and reboot the computer again.
 3. Are the motherboard switch settings or jumpers accurate? Is the computer set up correctly for the ProDesigner IIs? See chapter 1 for more information on setting up your computer.

4. Are your computer and monitor plugged in? Check the power cables to your computer and monitor.

Symptom 2 *The computer gives an error of 1 long beep and 2 short beeps at power up.*

- Check**
1. Take a look at the check points for symptom 1, steps 1 through 4.

Symptom 3 *The computer seems to boot up properly but there is no display.*

- Check**
1. Is your monitor plugged in? Check the power cable to your monitor.
 2. Is your monitor cable fastened securely and properly? Check both the connection at the monitor and at the ProDesigner IIs.
 3. Is your monitor cable the correct kind for the ProDesigner IIs? Check chapter 1 for the proper pin out information to determine if your cable is correct.
 4. Is there another display adapter in your system that may be using the same memory addressing? If so, change its addressing or remove it from the system and try booting the computer again.
 5. Are your ProDesigner IIs and motherboard switch settings and jumpers correct? See chapter 1 to double check them.

Symptom 4 *The display loses synchronization once it gets into a graphics program.*

- Check**
1. Is the vertical hold on your monitor properly set?
 2. Is your software properly installed for your current application? Check Chapter 3 for Device Driver information.

3. Is your monitor able to display the graphics mode you are using? Double check your monitor specifications and determine if you are operating a graphics mode that your monitor simply cannot handle.
4. Are you using the correct vertical refresh rate for your monitor? Check the switch setting (SW1 and SW2) in chapter 1.

Symptom 5 *The ProDesigner IIs works well in another brand computer, but not at all in mine.*

Check

1. First, take a look at the check points for symptom 1, steps 1 through 4. It is a pretty good guess that the problem lies not in the ProDesigner IIs if it is working properly in another system.
2. Does your computer have a VGA compatible BIOS? Some older computers do not have a BIOS that supports the VGA. If this is the case, purchase a compatible BIOS.
3. Is your computer 100% compatible with the IBM PC standards? Some computers will not support the IBM standard I/O and Video BIOS memory requirements of the VGA.

Symptom 6 *I have tried everything in this troubleshooting guide and I still cannot get the ProDesigner IIs to work properly, if at all.*

Check

Call the nearest Orchid Technical Support Department.

■ ProDesigner IIs Technical Specifications

Part Number:

GC-1617-00 ProDesigner IIs (512 KB)

GC-1618-00 ProDesigner IIs (1024 KB)

Upgrade RAM Chips:

256KB x 4, 80 nanosecond or faster DRAM

Computers Supported:

ISA machines: PC, XT, AT, 286, 386,
PS/2 models 25, 30,
and compatibles

EISA machines: Northgate EISA based
486, Altos 486, Intel 386

BUS Speed

8, 10 and 12 MHz

BIOS:

16-bit

Bus Connector:

16-bit or 8-bit

Card Size:

8.25 x 4.124 (3/4 length)

Output Connector:

DB-15 (analog)

Video RAM:

Expandable: 512KB to 1024KB

Additional Features:

Supports

72 Hz Vertical Scan Refresh Rate

Removable RAMDAC for future upgrade to Sierra HC or EDSUN CEG, or similar RAMDAC.

1024 x 768 in 256 colors (1 MB version)

1024 x 768 with Non-interlaced or Interlaced monitors

132 Column Modes with multi-frequency or fixed frequency monitors

2 Software Fonts

Hardware Horizontal Pan/Vertical Scroll

Auto Bus Sense

Optional Translation ROM

Memory Address Segments:

RAM: A000-BFFF

ROM: C000-C5FF, C680-C7FF

I/O Address: 3B0-3DF (IBM standard)

DMA: No DMA channels exist

Interrupt: Interrupt 2 is used to indicate vertical retrace in some modes (software programmable)

Temperature:

Operating: from 0 to 50 degrees C

Storage: from -25 to 90 degrees C

Humidity:

Operating: from 15% to 90%

Storage: from 0% to 90%



These mode numbers can be used with XMODE.COM to achieve the desired resolution.

See chapter 2 for information on using XMODE.COM.

ProDesigner IIs Video Modes			
Mode #	Resolution	Text or Graphics	Colors
00	40 X 25	Text	16
01	40 X 25	Text	16
02	80 X 25	Text	16
03	80 X 25	Text	16
04	320 X 200	Graphics	4
05	320 X 200	Graphics	4
06	640 X 200	Graphics	2
07	80 X 25	Text	Mono
0D	320 X 200	Graphics	16
0E	640 X 200	Graphics	16
0F	640 X 350	Graphics	Mono
10	640 X 350	Graphics	16
11	640 X 480	Graphics	2
12	640 X 480	Graphics	16
13	320 X 200	Graphics	256
22	132 X 44	Text	16
23	132 X 25	Text	16
24	132 X 28	Text	16
25	640 X 480	Graphics	16
26	80 X 60	Text	16
29	800 X 600	Graphics	16
2A	100 X 40	Text	16
2D	640 X 350	Graphics	256
2E	640 X 480	Graphics	256
2F	640 X 400	Graphics	256
30	800 X 600	Graphics	256
37	1024 X 768	Graphics	16
38	1024 X 768	Graphics	256

Table 4.1: ProDesigner IIs Video Modes

How to obtain the Translation ROM

You may purchase the Translation ROM from the Orchid Technology Technical Support department. This ROM permits MDA, HGC, CGA and EGA display standards to operate on monitors that support the VGA standard 31.5 KHz frequency.

The Translation ROM bridges the gap between those monitors that support multifrequency operation at higher frequencies than those required by the MDA, HGC, CGA and EGA display modes.



To purchase the Translation ROM contact our Technical Support staff. A member of the staff will explain the cost and the methods of payment at that time.

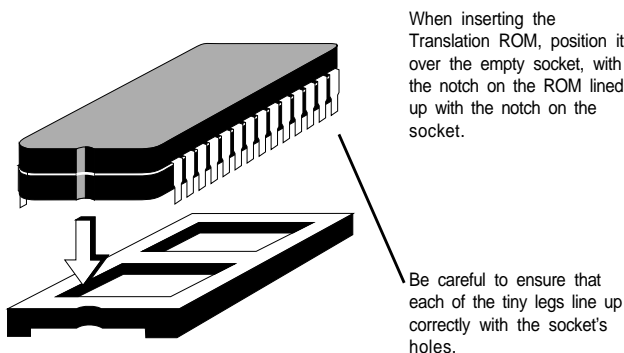

Figure 4.1: Positioning ROM Chip

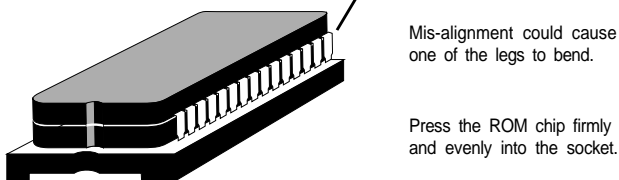

Figure 4.2: ROM Chip Inserted

How to obtain the Memory Upgrade Kit

If you would like to add more memory to your ProDesigner IIs you can call our Technical Support Staff and talk to us about which memory kit options are available, the costs of each, and the method of payment.

The figure below shows the locations for 512 KB and 1024 KB banks of RAM:

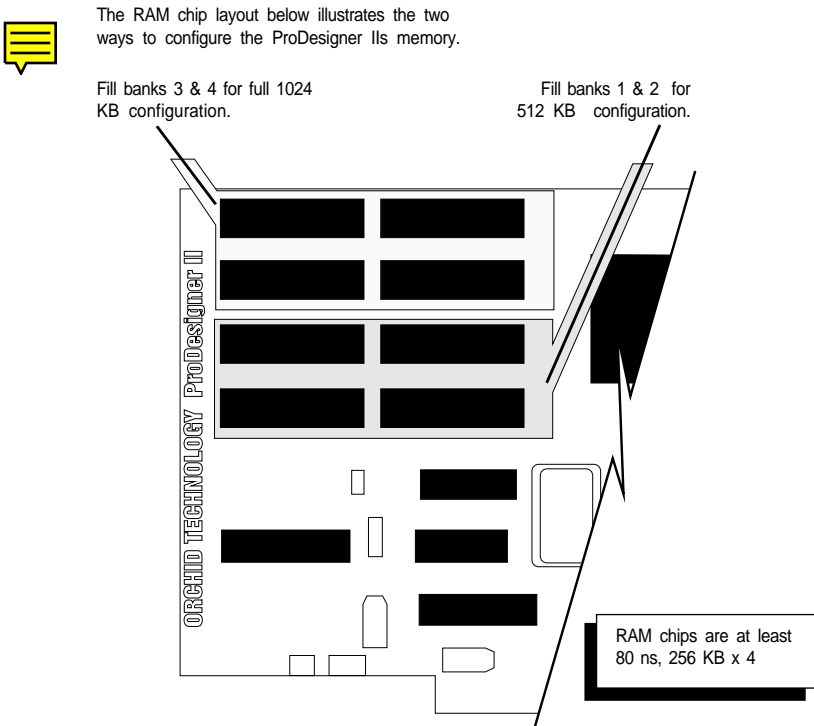

Figure 4.3: ProDesigner IIs Memory Upgrade

How to obtain a RAMDAC Upgrade Kit

If you would like to add a Sierra HiColor RAMDAC to your 512K ProDesigner IIs, you can call our Technical Support Staff and talk to us about DAC upgrade kits, the costs of each and the method of payment.

Each kit comes with the RAMDAC, drivers, hardware installation instructions and a chip extraction tool.

ET-4000 Technical Manual Available

A Technical Manual for the Tseng ET-4000 chip used on the ProDesigner IIs can also be obtained from the Orchid Technology Technical Support staff. The Technical Support staff will provide details concerning the price and shipping of the manual, as well as accepted methods of payment.

The ET-4000 Technical Reference manual includes information specific to the ET-4000 for technically proficient hardware and software developers, as well as the hobbyist. The manual does not include programming examples or information specific to the ProDesigner IIs BIOS or other hardware.



Feature Connector Pin Outs (VESA Standard)

The VESA standard Feature Connector (or Auxiliary Video Connector as it is sometimes called) is located at the top right corner of the ProDesigner IIs as shown in the figure below:

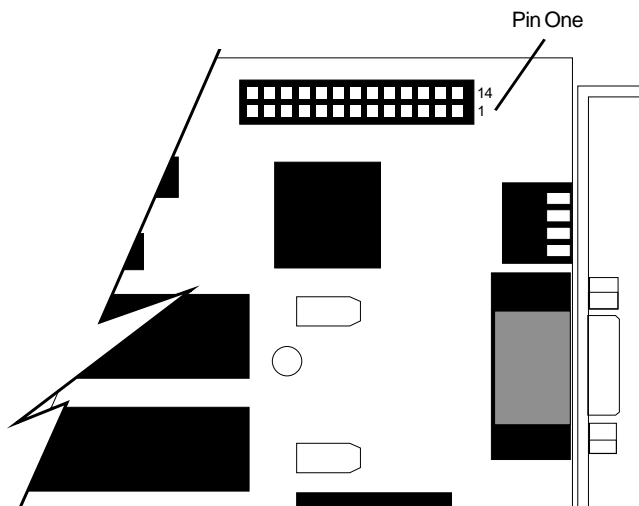

Figure 4.4: ProDesigner IIs Feature Connector Location

The feature connector permits third party add-on accessories to both share signals and share control of the VGA ircuitry. The feature connector's pin out information follows:

ProDesigner IIs Feature Connector Pin Outs							
Pin	Function	Pin	Function	Pin	Function	Pin	Function
01	PB	08	SI	15	Ground	22	Ground
02	PG	09	Dot Clock	16	Ground	23	Ground
03	PR	10	Blank	17	Ext Video Select	24	Ground
04	PI	11	HSync	18	Ext Sync Select	25	No Connect
05	SB	12	VSynC	19	Ext Dot Clk Select	26	No Connect
06	SG	13	Ground	20	No Connect		
07	SR	14	Ground	21	Ground		

Table 4.2: Feature Connector Pin Outs

FCC NOTICE

FCC# DDS7EF 0191-91-PRO
ProDesigner IIs
Certified compliant with FCC Class B limits, part 15

To meet FCC requirements, shielded cables are required to connect the unit to a Class B certified device

“This device complies with Part 15 of the FCC Rules. Operation is subject to the following two conditions: (1) this device may not cause harmful interference, and (2) this device must accept any interference received, including interference that may cause undesired operation.”

This equipment generates and uses radio frequency energy and, if not installed and used properly in strict accordance with the manufacturer’s instructions, may cause interference to radio or television reception.

This device has been tested and found to comply with the limits for a Class B computing device in accordance with the specifications in Subpart J of Part 15 of FCC Rules, which are designed to provide reasonable protection against such interference in a residential installation. Only equipment (computer input/output devices, terminals, printers, etc.) certified to comply with the Class B limits may be attached to this product.

If this equipment causes interference to radio or television reception, which can be determined by turning the equipment off and on, the user is encouraged to try and correct the interference by one or more of the following measures:

1. Reorient the receiving antenna.
2. Relocate the computer with respect to the receiver.
3. Move the computer away from the receiver.
4. Plug the computer into an outlet which resides on a different circuit breaker than the receiver.
5. If necessary, consult your dealer, or an experienced radio or television technician for additional suggestions.

You may find the booklet **How To Identify and Resolve Radio-TV Interference Problems** helpful. It was prepared by the Federal Communications Commission and is available from the U.S. Government Printing Office, Washington, DC 20402. Refer to stock number: 004-000-00345-4.

Orchid Technology is not responsible for any radio or TV interference caused by unauthorized modifications to this equipment. It is the responsibility of the user to correct such interference.

Operation with non-certified equipment is likely to result in interference to radio and TV reception. The user must use shielded interface cables in order to maintain the product within FCC compliance.

INDEX



15 pin video connector- 1.2, 1.14
45Hz Vertical Refresh (1024x768 - interlaced)- 1.5
60Hz Vertical Refresh (various modes)- 1.5, 1.6
70Hz Vertical Refresh (1024x768)- 1.6
72Hz Vertical Refresh (various modes)- 1.6



A

ANSI.SYS
 See XANSI.SYS
AutoCAD - 3.2
 Drivers Installation
 See PINSTALL.EXE
Orchid/Panacea Display List Driver- 3.2
Orchid/Panacea PanaRender-VGA Plus- 3.2



C

CGA
 See XMODE.COM



D

Device Drivers- 3.2
 See also Windows 3.0, AutoCAD, Lotus 1-2-3,
 Ventura Publisher, WordStar, WordPerfect,
 Orchid/Panacea DLD, Orchid/Panacea
 PanaRender-VGA Plus
DYNASCAN.COM- 2.1, 2.5



E

EGA
 See XMODE.COM

Extended high resolution modes
 See XMODE.COM
Extended text modes
 See XANSIS.SYS

F

Feature Connector (VESA Compatible)- 4.11
 Location of- 1.2
 Pin Out Information- 4.11

H

Hardware Emulation
 See XMODE.COM
Help
 Troubleshooting- 4.2
HGC
 See XMODE.COM
High Resolution Drivers
 See Device Drivers

I

Installation- 1.1
 AT (286/386) Compatibles- 1.4
 Installing the ProDesigner IIs- 1.11
 Interlaced monitor (1024 x 768)- 1.5
 Motherboard Switches- 1.3
 PC Compatibles- 1.3
 Preparing Your Computer- 1.3
 Preparing your ProDesigner IIs- 1.4
 XT Compatibles- 1.3
PINSTALL.EXE- 2.1, 3.2
IRQ2 Interrupt IRQ2
 See Jumper Settings

J

Jumpers

- Locations of Jumper Blocks- 1.2
- Jumper Settings- 1.8
 - Jumper JP1 (IRQ2)- 1.9
 - Enable/Disable IRQ2 Interrupt- 1.9
 - Vertical Interrupt IRQ2- 1.9
 - Jumper JP2 (CMP)- 1.10
 - Motherboard Compatibility- 1.10

L

- Lotus 1-2-3 2.x- 3.2
 - Drivers Installation
 - See PINSTALL.EXE

M

- MDA
 - See XMODE.COM
- Memory Upgrade - 4.9
- Microsoft Windows Driver Installation - 3.2, 3.3
- Monitor Cable Pin-out Information- 1.12
- Monitor Vertical Refresh Rates
 - Setting with DYNASCAN.COM- 2.5
 - Switch Settings-1.5, 1.6
 - Vertical Refresh Rate Settings Table- 1.6

N

- Network Considerations - 3.3

O

- OS/2 Presentation Manager Drivers- 3.1
- ORCAI-16.EXE and ORCAI256.EXE- 2.2, 2.9

- 8514/A driver- 2.9
- 8514/A Emulation Modes- 2.9
- ORCHDVSA.EXE- 2.2, 2.7
 - VESA BIOS Extension Modes- 2.7
- Orchid/Panacea DLD (Display List Driver)- 3.2
 - Driver Installation
 - See PINSTALL.EXE
- Orchid/Panacea PanaRender-VGA Plus- 3.2
 - Drivers Installation
 - See PINSTALL.EXE

S

- Software Developer's Reference Manual- 4.10
- Speed Booster Option Switch- 1.8
- SPEED_UP.SYS- 2.1, 2.7, 3.2
- Switch Settings- 1.4
 - SW1 and SW2: Monitor Refresh Rates- 1.5, 1.6
 - SW3: Translation ROM- 1.7
 - SW4: Speed Booster Option- 1.8

T

- Technical Information- 4.5
- Translation ROM
 - How to obtain - 4.8
 - Switch setting - 1.7
- Troubleshooting- 4.2
 - Computer does not power-up, or respond- 4.2
 - Computer gives error beeps- 4.3
 - Computer seems to boot up properly, but...-4.3
 - Display loses synchronization- 4.3
 - Does not work with my brand computer- 4.4
 - Screen is completely blank- 4.2

U

- Upgrade Kits
 - See Translation ROM or Memory Upgrade

Utility Software/Programs- 2.1

V

- Ventura Publisher- 3.1
 - Drivers Installation
 - See PINSTALL.EXE
- Vertical Interrupt IRQ2
 - See Switch Settings
- Vertical Refresh Rates
 - 45Hz: 1024x768 (interlaced)- 1.5
 - 60Hz: 640x480, 800x600, 1024x768- 1.5, 1.6
 - 70Hz: 1024x768 (non-interlaced)- 1.6
 - 72Hz: 640x480, 800x600- 1.6
 - Flicker-Free Refresh Rates- vii, 1.6
 - Setting with DYNASCAN.COM- 2.5
 - Switch Settings-1.5, 1.6
 - Vertical Refresh Rate Settings Table- 1.6
- VESA (ORCHDVSA.EXE)- 2.2, 2.7
 - VESA BIOS Extension Modes Table- 2.7
 - VESA Compatible Feature Connector- 4.11
 - See also ORCHDVSA.EXE
- Video Display Setup - 3.3, 3.4
- Video Modes Table- 4.7
 - See also XMODE.COM
- Video Standards
 - See XMODE.COM

W

- Windows- 3.1
 - Drivers Installation
 - See PINSTALL.EXE
- WordPerfect- 3.1
 - Drivers Installation
 - See PINSTALL.EXE
- WordStar- 3.1
 - Drivers Installation

See PINSTALL.EXE

X

XANSI.SYS- 2.1, 2.6, 3.2

 Extended Text Modes (Table)- 2.6

 ANSI Command examples- 2.6

XEDIT.COM- 2.1, 2.8

XLOAD.COM- 2.1, 2.8

XMODE.COM- 2.1, 2.3

 Parameters- 2.4

 Using XMODE- 2.3

 XMODE CGA- 2.4

 XMODE EGA- 2.4

 XMODE HERC- 2.4

 XMODE MDA- 2.4

 XMODE VGA- 2.4



Orchid Technology
Fremont, California

Orchid France, S.A.R.L.
Colombes, France

Orchid Technology GmbH
Meerbusch, Germany

Orchid (Europe) Limited
Basingstoke, U.K.