



AUTO-SCANNING WITH DIGITAL CONTROL
COLOR DISPLAY MONITOR

Diamond Pro 900u

MODEL **NFJ9905SKHUW**
USER'S GUIDE



For future reference, record the serial number of your display monitor in the space below:

SERIAL No.

The serial number is located on the rear cover of the monitor.

CAUTION

The power cord provided with this monitor is designed for safety and must be used with a properly grounded outlet to avoid possible electrical shock.

Do not remove the monitor cabinet as this can expose you to very high voltages and other hazards.

ANMERKUNG:

Dieser Monitor erfüllt die Anforderungen der deutschen Ergonomie-Norm ZH1/618/10.80 bei Verwendung der beiden folgenden Timing:

Auflösung	Videoeingang	fH(kHz)	fV(Hz)	Interlace/Non-Interlace
1280x1024	Analog RGB, 0.7Vs-s	91.1	85.0	Non-Interlaced

Aus ergonomischen Gründen wird empfohlen, die Grundfarbe Blau nicht auf dunklerem Untergrund zu verwenden (schlechte Erkennbarkeit, Augenbelastung bei zu geringem Zeichenkontrast).

Bei hellem Hintergrund empfehlen wir aus ergonomischen Gründen nur Vertikalfrequenzen größer oder gleich 70Hz zu verwenden.

Zur Trennung vom Netz ist der Netzstecker aus der Steckdose zu ziehen, welche sich in der Nähe des Gerätes befinden muß und leicht zugänglich sein soll.

Das Gerät stellt sich automatisch auf die zutreffende Nennspannung ein.

この装置は、情報処理装置等電波障害自主規制協議会(VCCI)の基準に基づくクラスB情報技術装置です。この装置は、家庭環境で使用することを目的としていますが、この装置がラジオやテレビジョン受信機に近接して使用されると、受信障害を引き起こすことがあります。

取扱説明書に従って正しい取り扱いをしてください。

高調波ガイドライン適合品

Trademark

IBM, PC, PS/2, PS/V, Personal System/2 are registered trademarks of International Business Machines Corp.

Apple Macintosh is a registered trademark of Apple Computer, Inc.

Quadra is a trademark of Apple Computer, Inc.

UNIX is a registered trademark in the United States and other countries, licensed exclusively through X/Open Company Limited.

ENERGY STAR is a U.S. registered mark.

RADIO INTERFERENCE REGULATIONS STATEMENT FOR U.S.A.

This equipment has been tested and found to comply with the limits for a Class B digital device, pursuant to Part 15 of the FCC Rules. These limits are designed to provide reasonable protection against harmful interference in a residential installation. This equipment generates, uses and can radiate radio frequency energy and, if not installed and used in accordance with the instructions, may cause harmful interference to radio communications. However, there is no guarantee that interference will not occur in a particular installation. If this equipment does cause harmful interference to radio or television reception, which can be determined by turning the equipment off and on, the user is encouraged to try to correct the interference by one or more of the following measures:

- Reorient or relocate the receiving antenna.
- Increase the separation between the equipment and receiver.
- Connect the equipment into an outlet on a circuit different from that to which the receiver is connected.
- Consult the dealer or an experienced radio/TV technician for help.

THIS PRODUCT HAS BEEN TESTED AND FOUND TO COMPLY WITH THE LIMITS WITH SIGNAL CABLE SC-B102. USE IT TO REDUCE THE POSSIBILITY OF CAUSING INTERFERENCE TO RADIO, TELEVISION, AND OTHER ELECTRIC DEVICES.

NO USER SERVICEABLE PARTS INSIDE. DO NOT ATTEMPT TO MODIFY THIS EQUIPMENT. IF MODIFIED, YOUR AUTHORITY TO OPERATE THIS EQUIPMENT MIGHT BE VOIDED BY FCC.

WARNING!

This product is not designed for use in life support devices and Mitsubishi Electric corporation makes no representations to the contrary. Life support devices are those devices which are used to measure, diagnose, or evaluate the tissue, systems or functions of the human body; or other devices employed to support or sustain life or good health.

MANUFACTURER DECLARATION FOR CE-MARKING:

We, Mitsubishi Electric Corp., declare under our sole responsibility, that this product is in conformity with the following standards:

EN60950
EN55022 Class B
EN50082-1
EN61000-3-2
EN61000-3-3

following the provisions of:

73/23/EEC Low Voltage Directive
89/336/EEC EMC Directive

As an ENERGY STAR Partner, Mitsubishi Electric Corporation has determined that this product meets the ENERGY STAR guidelines for energy efficiency.

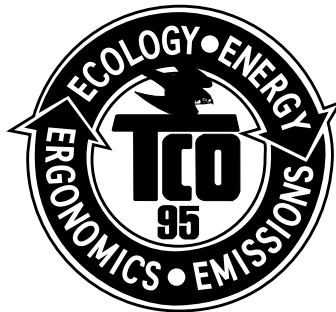

Congratulations! You have just purchased a TCO '95 approved and labelled product! Your choice has provided you with a product developed for professional use. Your purchase has also contributed to reducing the burden on the environment and to the further development of environmentally-adapted electronic products.

Why do we have environmentally-labelled computers?

In many countries, environmental labelling has become an established method for encouraging the adaptation of goods and services to the environment. The main problem as far as computers and other electronic equipment are concerned is that environmentally harmful substances are used both in the products and during their manufacture. Since it has not been possible so far for the majority of electronic equipment to be recycled in a satisfactory way, most of these potentially damaging substances sooner or later enter Nature.

There are also other characteristics of a computer, such as energy consumption levels, that are important from both a working and natural environment viewpoints. Since all types of conventional electricity generation have a negative effect on the environment (acidic and climate-influencing emissions, radioactive waste, etc.), it is vital to conserve energy. Electronic equipment in offices consumes an enormous amount of energy, since it is often routinely left running continuously.

What does labelling involve?

This product meets the requirements for the TCO '95 scheme, which provides for international environmental labelling of personal computers. The labelling scheme was developed as a joint effort by the TCO (The Swedish Confederation of Nature Conservation) and NUTEK (The National Board for Industrial and Technical Development in Sweden).

The requirements cover a wide range of issues: environment, ergonomics, usability, emission of electrical and magnetic fields, energy consumption and electrical and fire safety.

The environmental demands concern among other things restrictions on the presence and use of heavy metals, brominated and chlorinated flame retardants, CFCs (freons), and chlorinated solvents. The product must be prepared for recycling and the manufacturer is obliged to have an environmental plan, which must be adhered to in each country where the company implements its operational policy.

The energy requirements include a demand that the computer and / or display after a certain period of inactivity shall reduce its power consumption to a lower level, in one or more stages. The length of time to reactivate the computer shall be reasonable for the user.

Labelled products must meet strict environmental demands, for example in respect of the reduction of electric and magnetic fields, along with physical and visual ergonomics and good usability.

In and after the middle of this page, you will find a brief summary of the environmental requirements met by this product. The complete environmental criteria document may be ordered from:

TCO Development Unit

S-114 94 Stockholm

Sweden

Fax: +46 8 782 92 07

E-mail (Internet): development@tco.se

Current information regarding TCO'95 approved and labelled products may also be obtained via the Internet, using the address:

<http://www.tco-info.com/>

TCO'95 is a co-operative project between



Environmental Requirements

Brominated flame retardants are present in printed circuit boards, cabling, casings and housings, and are added to delay the spread of fire. Up to 30% of the plastic in a computer casing can consist of flame-retardant substances. These are related to another group of environmental toxins, PCB, and are suspected of giving rise to similar harm, including reproductive damage in fish-eating birds and mammals. Flame retardants have been found in human blood and researchers fear that they can disturb foetus development.

Bio-accumulative* TCO'95 demands require that plastic components weighing more than 25 grammes must not contain flame retardants with organically bound chlorine or bromine.

Lead

can be found in picture tubes, display screen, solder and capacitors. Lead damages the nervous system and in higher doses, causes lead poisoning.

The relevant bio-accumulative* TCO'95 requirement permits the inclusion of lead, as no replacement has yet been developed.

Cadmium

is present in rechargeable batteries and in the colour-generating layers of certain computer displays. Cadmium damages the nervous system and is toxic in high doses.

The relevant bio-accumulative *TCO'95 requirement states that batteries may not contain more than 25 ppm (parts per million) of cadmium. The colour-generating layers of display screens must not contain any cadmium.

Mercury

Is sometimes found in batteries, relays and switches. Mercury damages the nervous system and is toxic in high doses. The relevant bio-accumulative*TCO'95 requirement states that batteries may not contain more than 25 ppm (part per million) of mercury.

demands require that no mercury is present in any of the electrical or electronic components concerned with the display unit.

CFCs (freons) are sometimes used for washing printed circuit boards and in the manufacture of expanded foam for packaging. CFCs break down ozone and thereby damage the ozone layer in the stratosphere, causing increased reception on Earth of ultra-violet light with consequent increased risks of skin cancer (malignant melanoma).

The relevant TCO'95 requirement: Neither CFCs nor HCFCs may be used during manufacture of the product or its packaging.

Bio-accumulative is defined as substances which accumulate within living organisms.

CONTENTS

1. INTRODUCTION	6
1.1 Features	6
1.2 Internal Preset Memory Capability	7
1.3 Power Management Function	7
1.4 DDC	8
1.5 Location Considerations	8
1.6 Cleaning Your Monitor	8
1.7 Unpacking	9
1.8 Tilt/Swivel Base	9
Screen Position Adjustment	9
1.9 Quick Operation Chart	10
2. PART NAME	11
2.1 Control Names	11
2.2 Function	11
3. INSTALLATION AND CONNECTION	13
3.1 AC Power Connection	13
3.2 Signal Cable Connection	13
3.2.1 Connecting to Any IBM VGA Compatible System	13
3.2.2 Connecting to An Apple Macintosh Computer	14
3.2.3 Connecting to a Unix Work Station & Third Party Graphics Card	14
3.2.4 BNC Connection	15
3.3 USB System Basic Application	16
3.4 Installation of USB Function	18
4. OSD(On Screen Display) FUNCTIONS	24
4.1 How to adjust the screen	24
4.2 Adjustment Items	26
4.3 USB Monitor Control	30
5. TROUBLESHOOTING	32
6. SPECIFICATIONS	35
7. APPENDIX	36
7.1 Monitor Signal Input Connector (DB9-15P)	36
7.2 SC-B102 Signal Cable	36
7.3 Macintosh Adapter AD-A205 settings	37

Congratulations on your purchase of the high resolution color monitor. We designed this monitor to provide you with years of reliable trouble-free operation.

This guide tells you how to connect, adjust and care for your monitor. This guide also provides technical specifications and instructions for troubleshooting any basic problems you may experience with your monitor.

1.1 Features

The Diamond monitor is a 50cm/19"(46cm/18.0" Diagonal Viewable Image) intelligent, microprocessor-based monitor compatible with most analog RGB (Red, Green, Blue) display standards, including PS/V®, PS/2®, Apple® Macintosh® Centris, Quadra, Macintosh II and Power Macintosh family signals.

It provides crisp text and vivid color graphics with VGA, SVGA, XGA (non-interlaced), and most Macintosh compatible color video cards.

- The monitor's wide auto-scanning compatibility range makes it possible to upgrade video cards or software without purchasing a new monitor.
- Digitally controlled auto-scanning is done using an internal microprocessor, for horizontal scan frequencies between 30kHz and 95kHz, and vertical scan frequencies between 50Hz and 152Hz. The microprocessor-based intelligence allows the monitor to operate in each frequency mode with the precision of a fixed frequency monitor.
- The monitor contains resident memory for pre-programmed screen display standards and is also capable of storing additional user adjustment parameters.
- The monitor is capable of producing a non-interlaced maximum addressable resolution format of 1600 dots x 1200 lines. This display is well suited for windowing environments.
- Because of the analog signal inputs, the monitor can display an unlimited palette of colors that can be manually adjusted to suit your specific needs.
- The monitor has a power management function accorded to VESA™-DPMS™-standard. To save energy, the monitor must be connected to a system compliant with the VESA™ DPMS™-standard. (Refer to your computer and/or video card instructions for proper operation.)
- To ensure ease of installation and ongoing use, the monitor features Moire Clear Function and On-Screen Display (OSD) of all monitor set-up and adjustment functions.
- For use in a variety of applications, the monitor complies with UL 1950, CSA C22.2 No.950 and EN60950 for safety, FCC Class-B, VCCI Class-B and EN55022 Class-B for EMI, MPR-II, ISO 9241-3, ISO9241-7 and ISO9241-8 for ergonomics. The monitor also complies with TCO'95 guideline for environmental safe use.
- Digital Chassis design for lighter, more compact enclosure and increased screen performance.
- DIAMONDTRON NF CRT with 0.25 - 0.27mm variable pitch aperture-grille mask, advanced-focus P-NX DBF (Dynamic Beam Forming) electron gun and high contrast optical-quality coating.
- The monitor complies with Video Electronics Standards Association (VESA™) DDC™1/2B(EDID) specification. If your computer provides DDC™1/2B(EDID) function, setup will be done automatically.
- Innovative CRT technology provides a naturally flat, non-concave screen image.
- Flat CRT surface ensures an optically perfect image across the entire screen.
- Flat surface with anti-reflection coating minimizes glare from ambient light.
- USB self-powered hub with 2 upstream ports and 3 downstream ports.

1.2 Internal Preset Memory Capability

To minimize adjustment needs, the factory has preset popular display standards into the monitor, as shown in Table 1. If any of these display standards are detected, the picture size and position are automatically adjusted. All of the factory presets may be overwritten by adjusting the user controls. The monitor is capable of automatically storing up to six additional display standards. The new display information must differ from any of the existing display standards by at least 1kHz for the horizontal scan frequency or 5Hz for the vertical scan frequency or the sync signal polarities must be different.

Table 1. Memory Buffer Factory Presets

PRESET				Fh (kHz)	Fv (Hz)	Polarity	
TIMING						H	V
640	x	480	N.I.	31.5	60.0	-	-
640	x	480	N.I.	37.5	75.0	-	-
800	x	600	N.I.	46.9	75.0	+	+
1024	x	768	N.I.	60.0	75.0	+	+
1152	x	870	N.I.	68.7	75.1	-	-
1280	x	1024	N.I.	80.0	75.0	+	+
1280	x	1024	N.I.	91.1	85.0	+	+
1600	x	1200	N.I.	93.7	75.0	+	+

1.3 Power Management Function

The monitor has the power management function which reduces the power consumption of the monitor when not in use. There are two reduced power level modes.

■ Stand-by mode

When the horizontal sync signal is off, after about 10 seconds the monitor is switched to a stand-by mode which reduces the monitor power consumption to less than 15W. When the monitor is in the stand-by mode, the screen is off and the power-on indicator will be amber.

After the horizontal sync signal is restored, picture will be displayed within a few seconds.

■ Suspend mode

When the vertical sync signal is off, after about 10 seconds the monitor is switched to a suspend mode which reduces the monitor power consumption to less than 15W.

When the monitor is in suspend mode, the screen is off and the power-on indicator will be amber. After the vertical sync signal is restored, picture will be displayed within a few seconds.

■ Power-off mode

When the horizontal sync signal and vertical sync signal are off, after about 10 seconds the monitor is switched to a power-off mode, which reduces the monitor power consumption to less than 8W.

When the monitor is in power-off mode, the screen is off, and the power-on indicator will be amber.

After both the sync signals are restored, picture will be displayed within several seconds.

1.4 DDC

The monitor includes the DDC™1 and DDC™2B feature. DDC (Display Data Channel) is a communication channel over which the monitor automatically informs the host system about its capabilities (e.g. each supported resolution with its corresponding timing).

DDC is routed through previously unused pins of the 15-pin VGA connector.

The system will perform "Plug and Play" feature if both, monitor and host, implement the DDC protocol.

1.5 Location Considerations

When setting up and using the monitor, keep the following in mind:

- * For optimum viewing, avoid placing the monitor against a bright background or where sunlight or other light sources may reflect on the display area of the monitor; place the monitor just below eye level.
- * Place the monitor away from strong magnetic or electromagnetic fields, such as high capacity transformers, electric motors, large current power lines, steel pillars, etc....
Magnetism can cause distortion in the picture and/or color purity.
- * Avoid covering the slots or openings of the monitor. Allow adequate ventilation around the monitor so the heat from the monitor can properly dissipate. Avoid putting the monitor into any enclosure that does not have adequate ventilation.
- * Avoid exposing the monitor to rain, excessive moisture, or dust, as this can cause a fire or shock hazard.
- * Avoid placing the monitor, or any other heavy object, on the power cord.
Damage to the power cord can cause a fire or electrical shock.
- * When transporting the monitor, handle it with care.

CAUTION

Keep your fingers away from the pivot area of the tilt/swivel base.

1.6 Cleaning Your Monitor

When clean the monitor, please follow these guidelines:

- * Always unplug the monitor before cleaning.
- * Wipe the screen and cabinet front and sides with a soft cloth.
- * If the screen requires more than dusting, apply a household window cleaner to a soft cloth to clean the monitor screen.

CAUTION

Do not use benzene, thinner or any volatile substances to clean the unit as the finish may be permanently marked. Never leave the monitor in contact with rubber or vinyl for an extended time period.

1.7 Unpacking

After you unpack the box you should have all of the items indicated in Figure 1. Save the box and packing materials in case you ship or transport the monitor. Complete and mail in warranty cards.

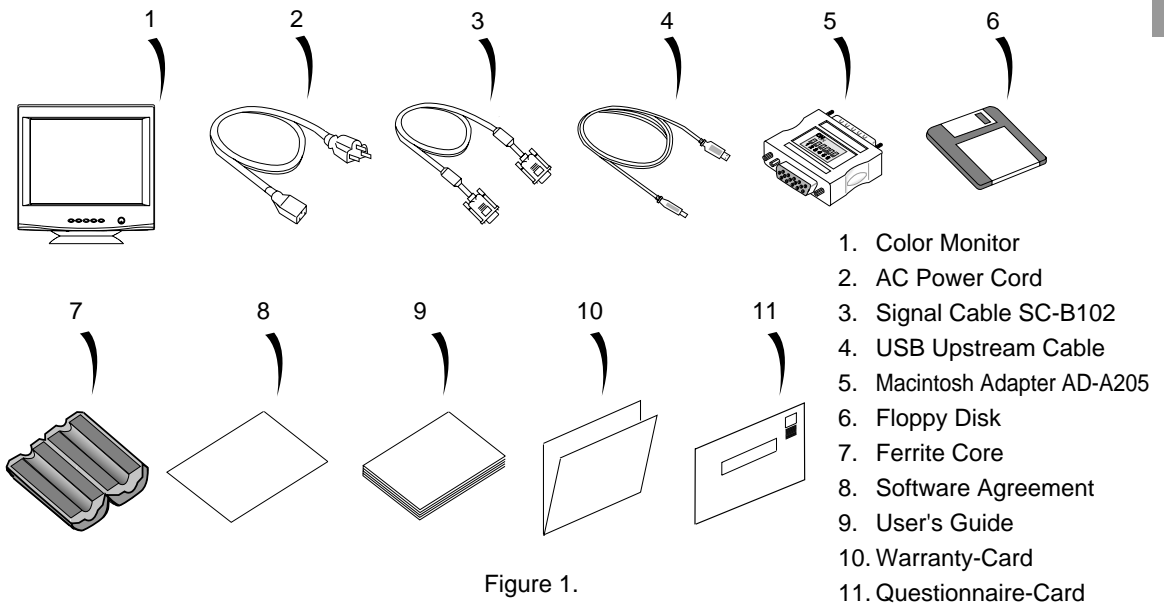

Figure 1.

1.8 Tilt/Swivel Base

The monitor comes with a tilt/swivel base. This enables you to position the monitor to the best angle and tilt for maximum viewing comfort.

Screen Position Adjustment

Adjust the tilt and rotation of the monitor by placing your hands at opposite sides of the case, as shown in Figure 2. You can adjust the monitor 90 degrees right or left, 15 degrees up or 5 degrees down, as shown below.

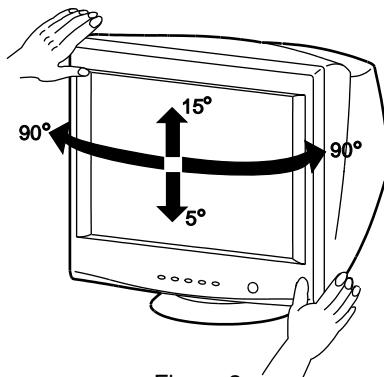

Figure 2.

2.1 Control Names

See Figures 3 and 4 for the location of the user controls, indicator and connectors. Each part is identified by number and is described individually.

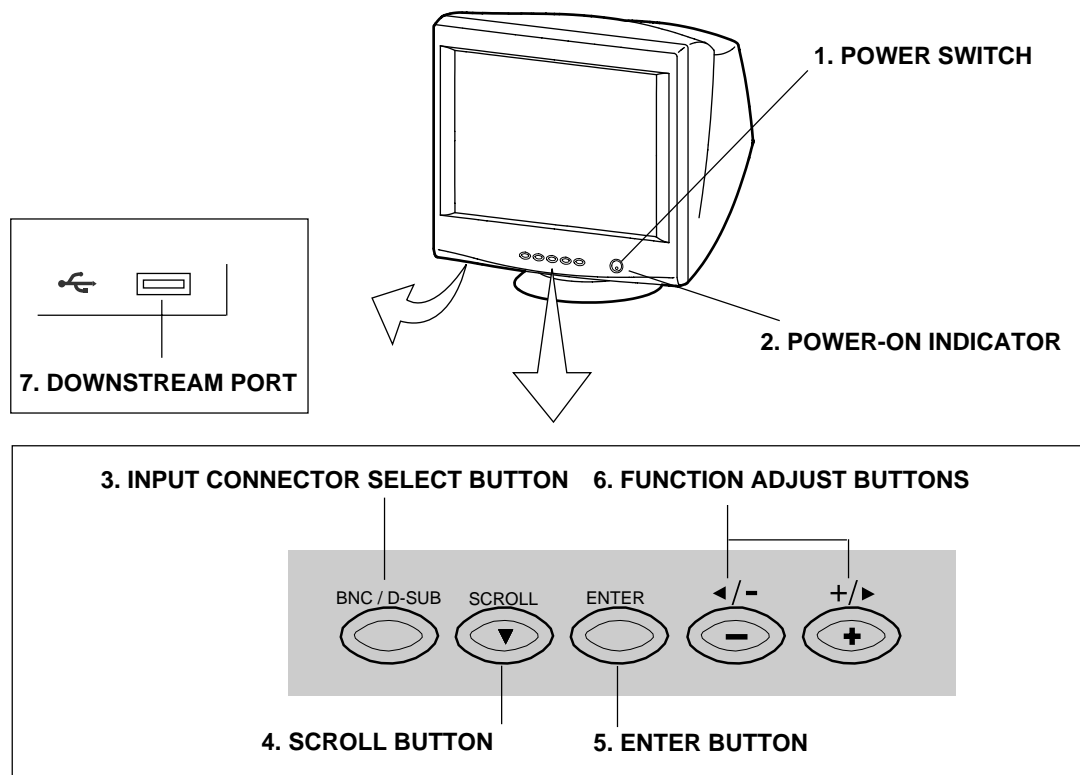

Figure 3

2.2 Function

1. **POWER SWITCH:** A push-on / push-off switch for AC power.
2. **POWER-ON INDICATOR:** This indicator illuminates at green when AC power is on, and illuminates at amber when the monitor is in the power management modes.
3. **INPUT CONNECTOR SELECT BUTTON:** Push to select the signal input connector, BNC or D-SUB.
4. **SCROLL BUTTON:** Push to select group icon.
5. **ENTER BOTTON:** Push to fix / unfix the item icon.
6. **FUNCTION ADJUST BUTTONS:** Push the adjust buttons to select item icon and to adjust the item selected.
7. **DOWNSTREAM PORT:** To connect USB camera, keyboard, mouse, etc.

REAR

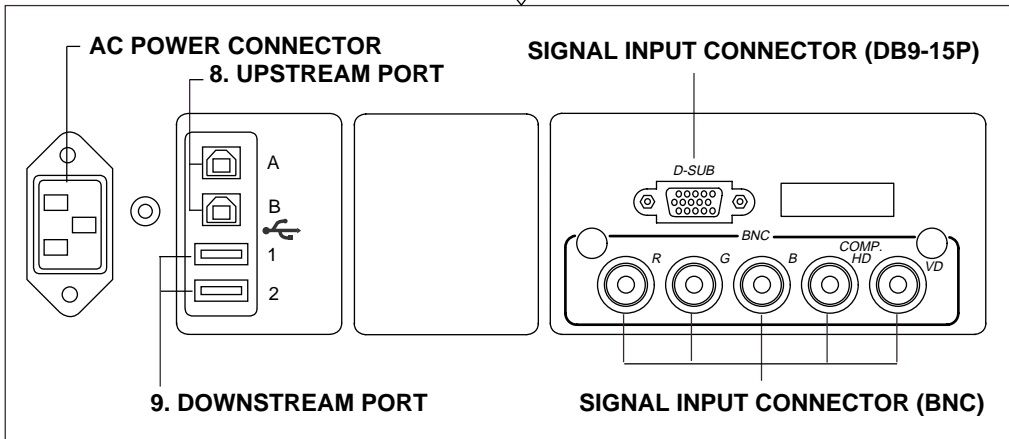
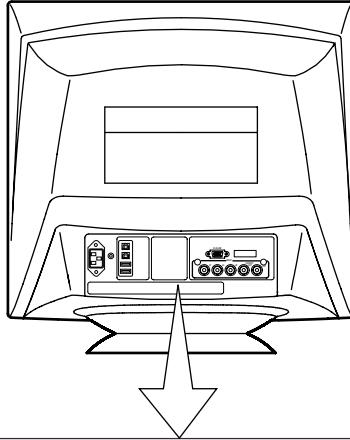

Figure 4

- 8. **UPSTREAM PORT:** To connect to USB equipped computer(s).
- 9. **DOWNSTREAM PORT:** To connect to USB equipped peripherals, e.g, USB camera, keyboard, printer, etc.

On the back of the monitor four kinds of plug-in connections are provided: AC power connector for the AC input, DB9-15P connector and BNC connector for video signal input and USB ports for USB communication.

3.1 AC Power Connection

One end of the AC power cord is connected into the AC power connector on the back of the monitor. The other end is plugged into a properly grounded three-prong AC outlet. The monitor's auto-sensing power supply can automatically detect 100-120V AC or 220-240V AC and 50 or 60Hz.

3.2 Signal Cable Connection

The attached video signal cable provides a DB9-15P connector for the VGA compatible analog RGB outputs on your computer. Apple Macintosh computers can also be interfaced with using the included Mitsubishi Macintosh adapter AD-A205.

3.2.1 Connecting to Any IBM VGA Compatible System

Figure 5 shows the SC-B102 cable connection to the Video Graphics Array (VGA) port in an IBM Personal System/2® series, or any VGA compatible system.

1. Power off, the monitor and the computer.
2. Connect the one end of the SC-B102 cable to the DB9-15P connector on the VGA controller card.
3. Connect the other end of the SC-B102 cable to the DB9-15P receptacle on the back of the monitor.
4. Power on the computer, then the monitor.
5. After using the system, power off the monitor, then off the computer.

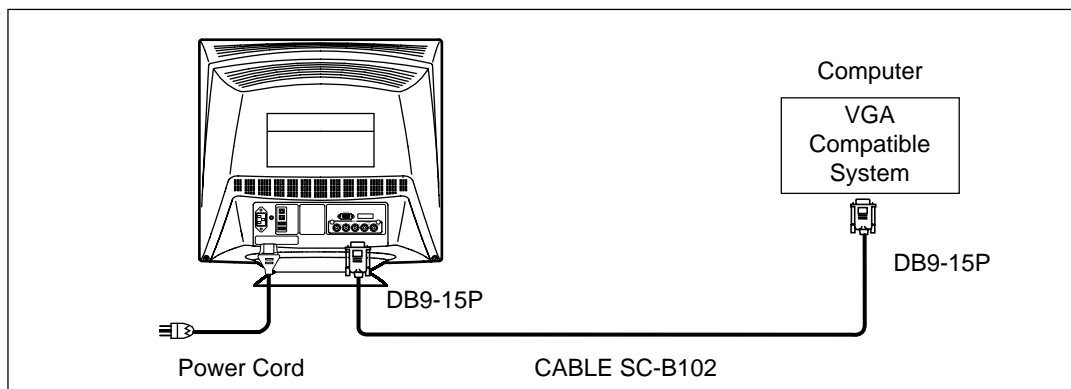

Figure 5.

CAUTION

The socket-outlet shall be installed near the equipment and shall be easily accessible. During servicing, disconnect the plug from the socket-outlet.

Même si le moniteur est mis hors tension il reste toujours alimenté. La prise secteur devrait ainsi être facilement accessible en cas d'urgence.

3.2.2 Connecting to An Apple Macintosh Computer

Figure 6 shows the SC-B102 cable and AD-A205 Adapter to the video port in an Apple Macintosh.

1. Power off, both the monitor and the computer.
2. Set the DIP switches of Macintosh Adapter according to the setting chart.
(See 7.3 Macintosh Adapter AD-A205 settings)
3. Connect the 15-pin (DB-15P) end of the AD-A205 Adapter to the straight 15-pin connector on the Macintosh video port on the CPU or on the video board.
4. Connect the sub-miniature 15-pin (DB9-15P) end of AD-A205 Adapter to the SC-B102 cable.
5. Connect the other end of the SC-B102 cable to the DB9-15P receptacle on the back of the monitor.
6. Power on the Macintosh, then the monitor.
7. After using the system, power off the monitor, then off the Macintosh.

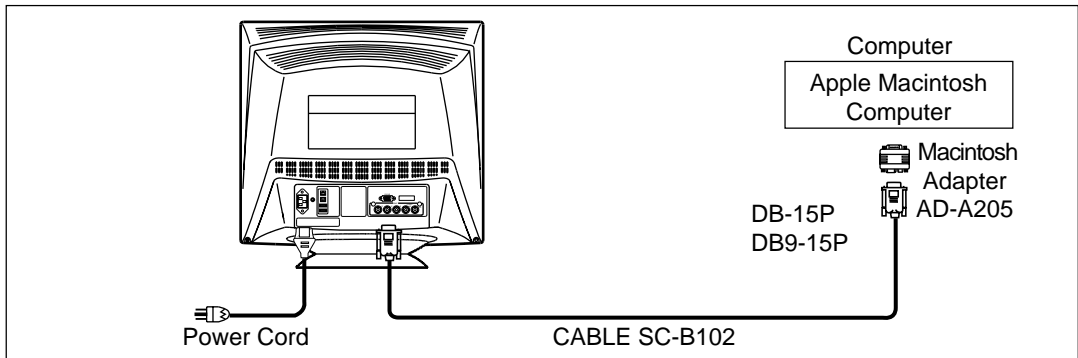

Figure 6.

3.2.3 Connecting to a Unix Workstation & Third Party Graphics Card

Figure 7 shows the SC-B102 or "75" coaxial cable (not supplied) connection to the graphics video card (PC-CAD and workstation).

1. Power off, both the monitor and the computer.
2. Connect one end of the SC-B102 cable or the "75" coaxial cable to the output connector on the CPU, or on the video board.
3. Connect the other end of the SC-B102 cable or the "75" coaxial cable to the DB9-15P receptacle or the BNC receptacles on the back of the monitor.
4. Power on the computer, then the monitor.
5. After using the system, power off the monitor, then off the computer.

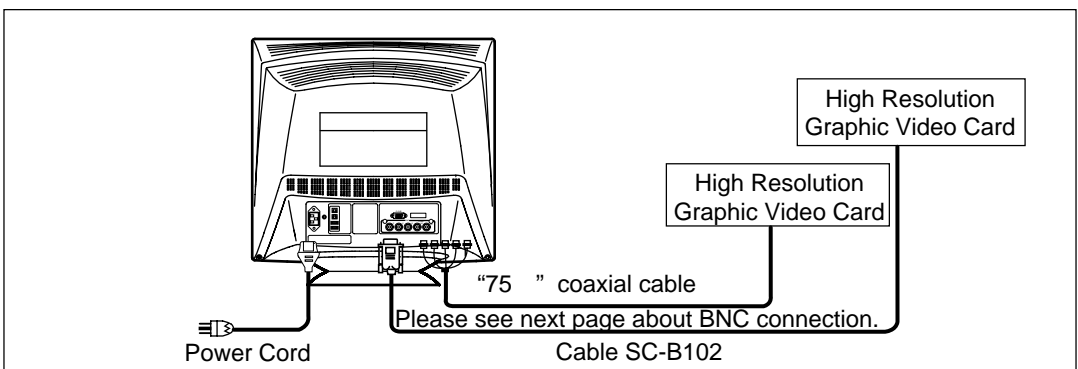
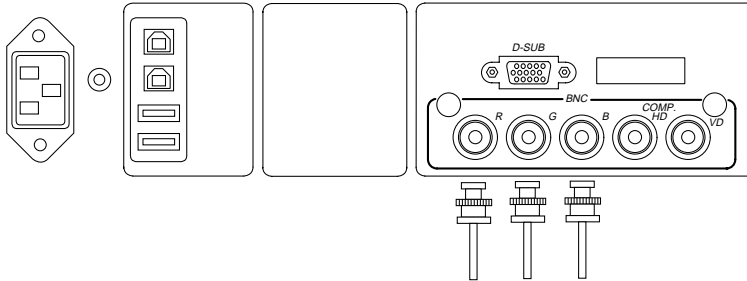

Figure 7.

3.2.4 BNC Connection

- (1) IN CASE OF A COMPOSITE SYNC ON GREEN VIDEO SIGNAL (SYNC ON GREEN):
Connect the R, G and B video signals to the BNC receptacles on the back of the monitor.



- (2) IN CASE OF EXTERNAL COMPOSITE SYNC SIGNAL:
Connect the R, G and B video signals and the Composite sync signal to BNC receptacles on rear panel, respectively.

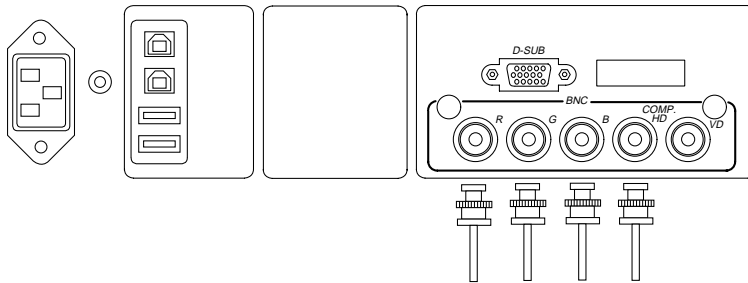

- (3) IN CASE OF SEPARATE HORIZONTAL AND VERTICAL SYNC SIGNALS:
Connect the R, G and B video signals and the horizontal and vertical sync signals to the BNC receptacles on the rear panel.

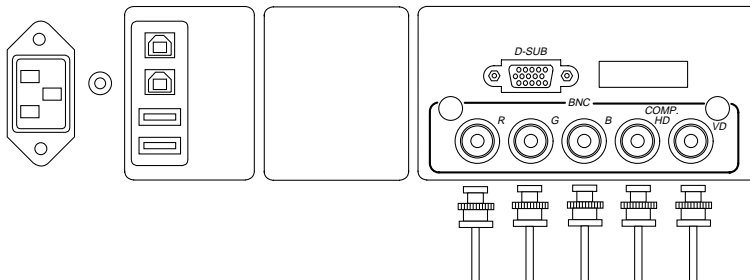

3.3 USB System Basic Application

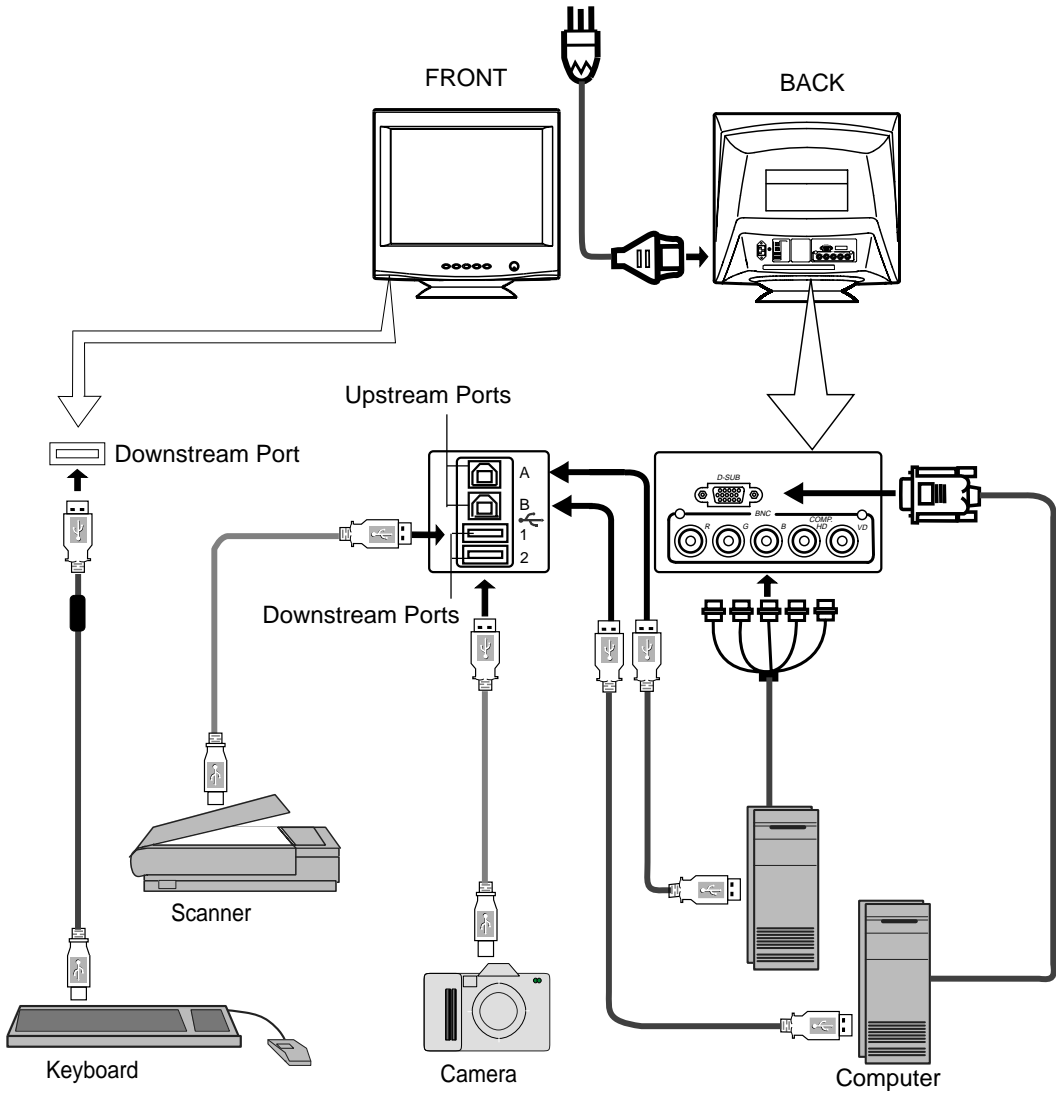

NOTE

The computer is required to have Windows 98 installed and USB functions. When connecting one computer, either Upstream port A or B is available. The Upstream port with that the computer is connected is detected automatically.

CAUTION

Use the included ferrite core with the USB cable which is connected to the USB connectors (Downstream) to reduce the possibility of causing interference to radio, television, and other electrical devices.

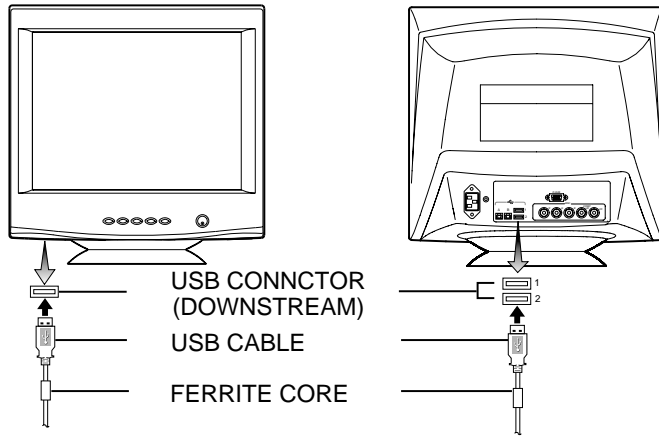

HOW TO MOUNT THE FERRITE CORE

Place the included ferrite core under the USB cable at approx. 1.2 in.(3 cm) from the USB plug.

Then, close the plastic case until you have a click.

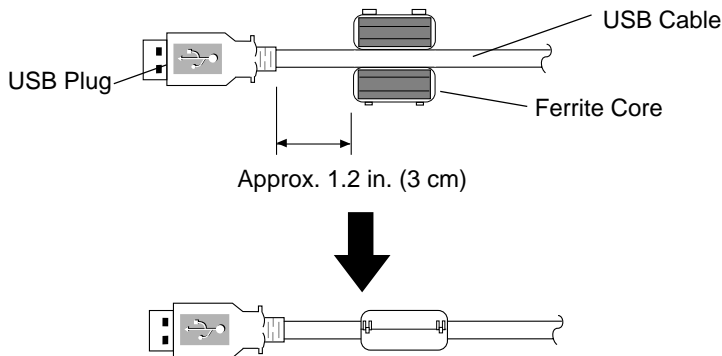

3.4 Installation of USB Function

1. Power on the display monitor and computer.
2. Enumerate Mitsubishi USB HUB using the following procedure.

NOTE

During the enumeration of Mitsubishi USB Hub, connect the keyboard and mouse equipped with USB function, to the computer and not to the downstream ports on the display monitor. After the enumeration, the keyboard and mouse can be used by connecting to the downstream ports.



- (1) Insert the included floppy disk in the computer.
- (2) Connect the computer and the display monitor with the included USB upstream cable.
- (3) Install 'INF' file from the included floppy disk. Figure 8 will appear.
- (4) Click "Next" on Figure 8 to get Figure 9.
- (5) Click "Finish" on Figure 9 to complete the enumeration of Mitsubishi USB HUB.

You can confirm that "Mitsubishi USB HUB" is successfully enumerated with the following method.

- Open "Device Manager" tab in "System" property under "Control Panel". Confirm that "Mitsubishi USB Hub" or "Generic USB HUB" is listed in "Universal Serial Bus Controller". If you can't confirm it, re-enumerate "Mitsubishi USB HUB" again by following (a) or (b).

- (a) Disconnect and connect the USB cable to the upstream port of the display monitor.
- (b) Power Off/On the display monitor.

NOTE

If the mark  appears with "Mitsubishi USB HUB" or "Generic USB HUB", then enumeration was unsuccessful. Select "Mitsubishi USB HUB" or "Generic USB HUB" marked with  mark and click "Remove" and "Refresh". After that, the enumeration is automatically started.

NOTE

The enumeration of USB HUB may be necessary for each USB port on the computer.



Figure 8



Figure 9



Figure 10

3. Enumerate the Mitsubishi Monitor Function using the following procedure.

- (1) Insert Windows 98 CD-ROM into your computer. Then, Figure 11 will appear.



Figure 11

- (2) Click "Next" on Figure 11 and Figure 12 will appear.



Figure 12

- (3) Click "Next" on Figure 12 and Figure 13 will appear.



Figure 13

- (4) Click “CD-ROM Drive(C)” and “(L)”, and click “Next”. Figure 14 will appear.



Figure 14

- (5) Click “Finish” on Figure 14 and Figure 15 will appear. Click “OK” on Figure 15 to complete Enumeration of Mitsubishi Monitor Function.

You can confirm that Enumeration of Mitsubishi Monitor Function is successful with the following method.

- Open “Device Manager” tab in “System” property under “Control Panel”. Confirm that “HID-compliant Device” and “USB Human Interface Device (or Mitsubishi USB Monitor)” are listed in “Human Interface Device”. If you can’t confirm it, re-enumerate “Mitsubishi Monitor Function” again by following (a) or (b).



Figure 15

- (a) Disconnect and connect the USB cable to the upstream port of the display monitor.
- (b) Power Off/On the display monitor.

NOTE

If the mark ① appears with “HID-Compliant Device” and/or “USB Human Interface Device (or Mitsubishi USB Monitor)”, the enumeration was unsuccessful. Select “HID-Compliant Device” and/or “USB Human Interface Device (or Mitsubishi USB Monitor)” marked with ① mark and click “Remove” and “Refresh”. After that, the enumeration is automatically started.



Figure 16

4. Install “USB Monitor Control Software” into computer using the following procedure.

- (1) Install “SETUP.EXE” after inserting the included floppy disk in computer.

CAUTION

Close all Windows programs before running this Setup program.

- (2) Click “Next” to continue with the Setup program.

- (3) A software license agreement appears on screen.
Click “Yes”, if you accept all the terms of the software license agreement on screen.
Click “No” to close the Setup program, if you do not accept the terms of the software licence agreement on screen.



Figure 17

- (4) Upon clicking “Yes”, Figure 18 will appear.
Select “Yes, I want to restart my computer now” or “No, I will restart my computer later” for your purpose. After removing the floppy disk from your computer, Click “Finish” to complete the installation of USB Monitor Control Software.

NOTE

Recommend to select “Yes, I want to restart my computer now” in order to complete the installation successfully.



Figure 18

You can confirm that the Setup program is successfully installed, with the following method ① or ②.

- ① Confirm that “Mitsubishi USB Monitor Console Application” is listed in the property of “Application Add/Remove” under “Control Panel”.

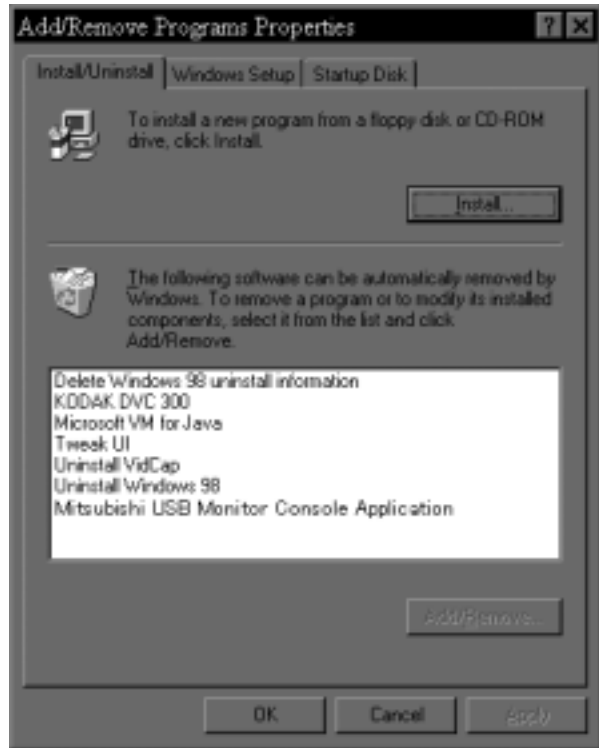

Figure 19

- ② Confirm that “USB Monitor” tab is added in “Display” property under “Control Panel”.

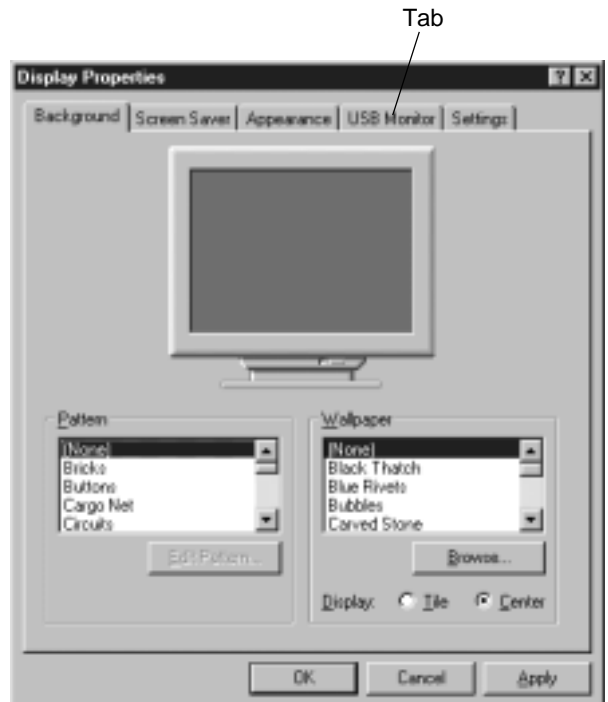

Figure 20

NOTE

The following should be observed in order to use the USB function reliably.

- Make sure all connections are made firmly and correctly.
- Make sure the operation of the devices connected to the downstream ports before changing USB Upstream ports. It may take approximately 15 seconds max. until the devices have been enumerated by the computer and start to operate after the Upstream ports are changed.
- Do not change the Upstream ports during enumeration to prevent errors of the operation of devices or application software.
- Do not unplug the USB cable during the enumeration.
- Close all Windows programs before disconnecting USB devices, USB cables or changing Upstream ports.
- Do not disconnect USB devices, USB cables or change Upstream ports while the USB Monitor control application is open.
- Do not switch off/on fast or repetitively.

4

OSD(On Screen Display) FUNCTIONS

4.1 How to adjust the screen

The monitor has an OSD(On Screen Display) function.

The following procedure shows how to adjust the screen with using the OSD function.

- (1) Turn on the monitor.

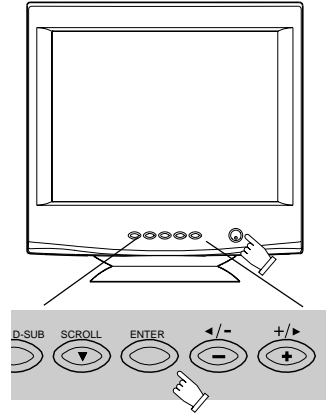

- (2) Press any button () to display the OSD screen. At the time, marks are blinking.

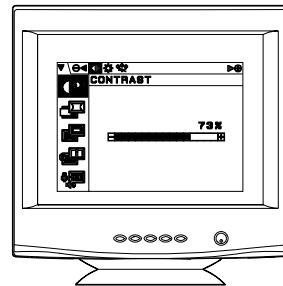

- (3) Select the group icon on Main Menu by pressing .

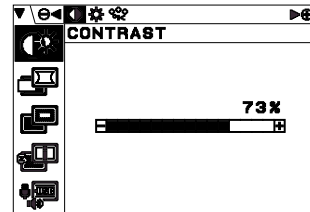
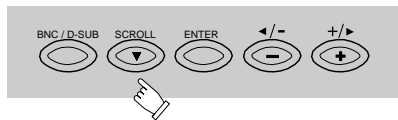



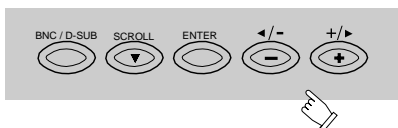

Main Menu

- (4) Select the item icon on Sub Menu by pressing or button.

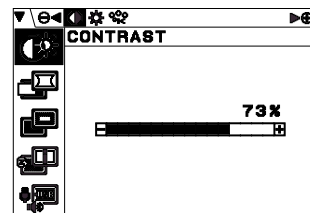



Sub Menu



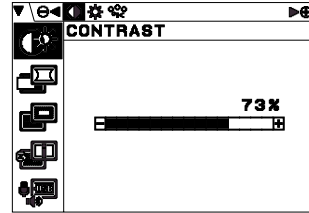
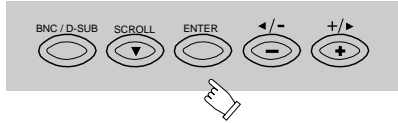

- (5) Fix the item icon by pressing the proceed button  .
  marks are blinking when fixed.



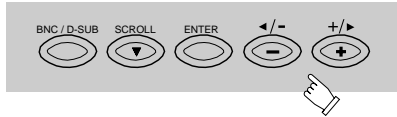

- (6) Adjust by pressing:  or  button.

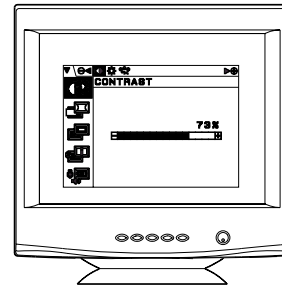

- (7) To select another item, press  button once again. The fixed condition will be cancelled.
 At the time,   marks are blinking.



- (8) If you don't press any button for about ten seconds, the OSD screen will disappear.
 Or pressing both  and  buttons simultaneously. The OSD screen will disappear quickly.

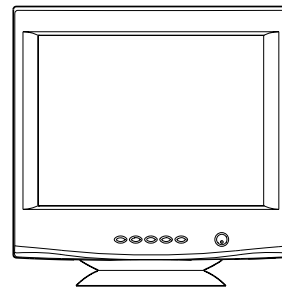
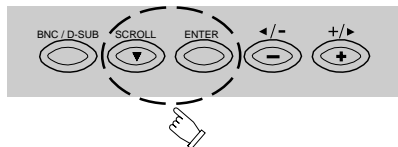



NOTE





















The condition of the disappeared OSD screen is memorized until turning off the display monitor. In case that the OSD screen is displayed again before turning off the display monitor, the latest OSD screen will appear.























4.2 Adjustment Items

X: Available

Items	Function	A	B	C	D
CONTRAST	Adjusts to the desired contrast level.		X		X
BRIGHT	Adjusts to the black level of the screen		X		X
COLOR TEMPERATURE	Adjusts the color temperature of the screen image.		X		X
H-SIZE	Adjusts the horizontal size of the image on the screen.	X		X	
H-PHASE	Adjusts the horizontal position of the image on the screen.	X		X	
V-SIZE	Adjusts the vertical size of the image on the screen.	X		X	
V-POSITION	Adjusts the vertical position of the image on the screen.	X		X	
PCC-AMP	Straightens the left and right sides of the screen image.	X		X	
PCC-PHASE	Adjusts the parallelism of the left and right sides of the screen image.	X		X	
PCC-CENTER	Adjusts the pincushioning near the vertical center of the screen.	X		X	
TOP-PCC	Adjusts the pincushioning at the top corners of the screen.	X		X	
BOTTOM-PCC	Adjusts the pincushioning at the bottom corners of the screen.	X		X	
PIN-BALANCE	Adjusts the curvature of the left and right sides of the screen image.	X		X	
KEY-BALANCE	Adjusts the vertical slant or tilt of the screen image.	X		X	
TOP-BALANCE	Adjusts the partiality on the top of the screen image.	X		X	
ROTATION	Adjusts the rotation or twist of the picture.				X
GEOMETRY RESET	Restore to factory preset level.				
H-STATIC	Adjusts the horizontal alignment of the red, green and blue beams.		X		X
V-STATIC	Adjusts the vertical alignment of the red, green and blue beams.		X		X
MOIRE CANCEL LEVEL	Adjusts the moire level on the screen.		X	X	
CORNER PURITY (TL)	Adjusts the purity of the top-left corners of the screen.		X		X
CORNER PURITY (TR)	Adjusts the purity of the top-right corners of the screen.		X		X
CORNER PURITY (BL)	Adjusts the purity of the bottom-left corners of the screen.		X		X
CORNER PURITY (BR)	Adjusts the purity of the bottom-right of the screen.		X		X
CLAMP PULSE POSITION	Use this function to eliminate excessive green or white background that may occur when both Sync-On-Green and external sync signals are applied to the monitor.			X	
VIDEO LEVEL	Selects video level 1.0V or 0.7V.				X
DEGAUSS	Eliminates possible color shading or impurity.				
POWER-SAVE	When adjusting ON, reduces the power consumption of the monitor when not in use.				X
CONTROL LOCK	Lock the OSD function to keep the OSD screen you desired.				X
OSD POSITION	Move the OSD screen position.				X
DIAGNOSIS	Indicate current Scanning frequency and factory or user preset timing number.				
LANGUAGE	Select the language used on OSD screen.				X
USB UP-STREAM	Select the Upstream port which you want to use.				X
USB PORT COMBINATION	Selects the combination of the Upstream port and signal input connector.				X

- A. Press "GEOMETRY RESET" to restore to the factory preset level.
- B. Press  and  buttons together, to restore to the factory preset level.
- C. Available to set for each signal timing.
- D. Setting does not change by the change of the signal timing.

Group Icon	Item Icon	Item	Press the Minus Button: 	Press the Plus Button: 
		CONTRAST	To decrease the contrast.	To increase the contrast.
		BRIGHT	To decrease the brightness.	To increase the brightness.
		COLOR TEMPERATURE	To increase the red color level.	To increase the blue color level.
		H-SIZE	To narrow the width of the image on the screen.	To expand the width of the image on the screen.
		H-PHASE	To move the image to the left.	To move the image to the right.
		V-SIZE	To narrow the height of the image on the screen.	To expand the height of the image on the screen.
		V-POSITION	To move the image down.	To move the image up.
		PCC-AMP	To collapse the center of the image.	To expand the center of the image.
		PCC-PHASE	To decrease the width at the top of the screen image and to increase the width at the bottom.	To increase the width at the top of the screen image and to decrease the width at the bottom.
		PCC-CENTER	To narrow the center of the image horizontally.	To expand the center of the image horizontally.
		TOP-PCC	To expand the width of the screen image near the corners of top.	To narrow the width of the screen image near the corners of top.
		BOTTOM-PCC	To expand the width of the screen image near the corners of bottom.	To narrow the width of the screen image near the corners of bottom.
		PIN-BALANCE	To move the top and bottom of the screen image to the right.	To move the top and bottom of the screen image to the left.
		KEY-BALANCE	To make the screen slant to the left.	To make the screen slant to the right.
		TOP-BALANCE	To move the top corners of the screen to the left.	To move the top corners of the screen to the right.
		ROTATION	To rotate to the left.	To rotate to the right.
		GEOMETRY RESET	_____	Restore to factory preset level.

Group Icon	Item Icon	Item	Press the Minus Button:   	Press the Plus Button:   
		H-STATIC	To move the red to the right and the blue to the left.	To move the red to the left and the blue to the right.
		V-STATIC	To move the red to the upper and the blue to the lower.	To move the red to the lower and the blue to the upper.
		MOIRE CANCEL LEVEL	To decrease the level of the moire-clear.	To increase the level of the moire-clear.
		CORNER PURITY (TL)	To adjust the purity condition on the top-left corner.	
		CORNER PURITY (TR)	To adjust the purity condition on the top-right corner.	
		CORNER PURITY (BL)	To adjust the purity condition on the bottom-left corner.	
		CORNER PURITY (BR)	To adjust the purity condition on the bottom-right corner.	
		CLAMP PULSE POSITION	To eliminate an excessive green or white-back ground that may occur when both Sync-On-Green and external sync signals are applied to the monitor. To clamp the video signal at the front of the H-Sync pulse.	To clamp the video signal at the back of the H-Sync pulse. If you connect to Macintosh, pressing plus button.
		VIDEO LEVEL	To select 1.0V of video input.	To select 0.7V of video input.
		DEGAUSS	_____	To eliminate possible color shading or impurity.
		POWER-SAVE	To select the constant power on mode.	To select the power-save mode.
		CONTROL LOCK	To unlock off the OSD function.	To lock the OSD function except for "BRIGHTNESS" and "CONTRAST".
		OSD POSITION	To move the OSD position to the left.	To move the OSD position to the right.
		DIAGNOSIS	It shows the current scanning frequency and Preset No.	
		LANGUAGE	To choose the language used on OSD. ENG.....English, FRA.....French, ITA.....Italian, GER.....Germany ESP.....Spanish, JPN.....Japanese	





NOTE

CONTROL LOCK:

This is to lock the OSD function to keep the OSD screen image you set.

Press plus button to lock the OSD function. You can adjust only "BRIGHTNESS" and "CONTRAST" at the condition.

Press minus button to unlock the locked condition.

Group Icon	Item Icon	Item	Press the Minus Button: 	Press the Plus Button: 
		USB UP-STREAM	<p>The USB functions of the computer connected to Upstream port ROOT-A become active.</p> <p>NOTE</p> <p>The Upstream port in active is colored by blue on the OSD screen. In case that either the Upstream port ROOT-A or ROOT-B is chosen by this function, the auto-change of the Upstream port is not available. It may take about 15 seconds until the USB devices have been recognized by the computer after the Upstream port is changed.</p>	<p>The USB functions of the computer connected to Upstream port ROOT-B become active.</p>
		USB PORT COMBINATION	<p>The Upstream port ROOT-A is assigned for signal input connector "D-SUB" and ROOT-B is assigned for "BNC"</p> <p>NOTE</p> <p>This function is to change the Upstream port automatically in corresponding to the change of signal input connector. This function is only available in case that both the Upstream ports are connected to the computers. It may takes 15 seconds until the USB devices have been recognized by the computer after the Upstream port is changed. In case that the computer chosen enters into a power management mode, the signal input connector and Upstream port are changed to others automatically. When the Upstream port which is connected to the computer not displays on the screen is selected, the operation of the USB devices connected to the Downstream ports is not shown on the screen of the display monitor.</p>	<p>The Upstream port ROOT-A is assigned for signal input connector "BNC" and ROOT-B is assigned for "D-SUB".</p>

4.3 USB Monitor Control

You can do monitor screen adjustments from your computer through the USB function equipped to the monitor, with the following procedure.

- (1) Open “display” in “control panel” to get “display property”.
Select “USB monitor” tab.
- (2) Click the adjustment item and adjust with the horizontal and/or vertical slide bar.

(Example of OSD Display)

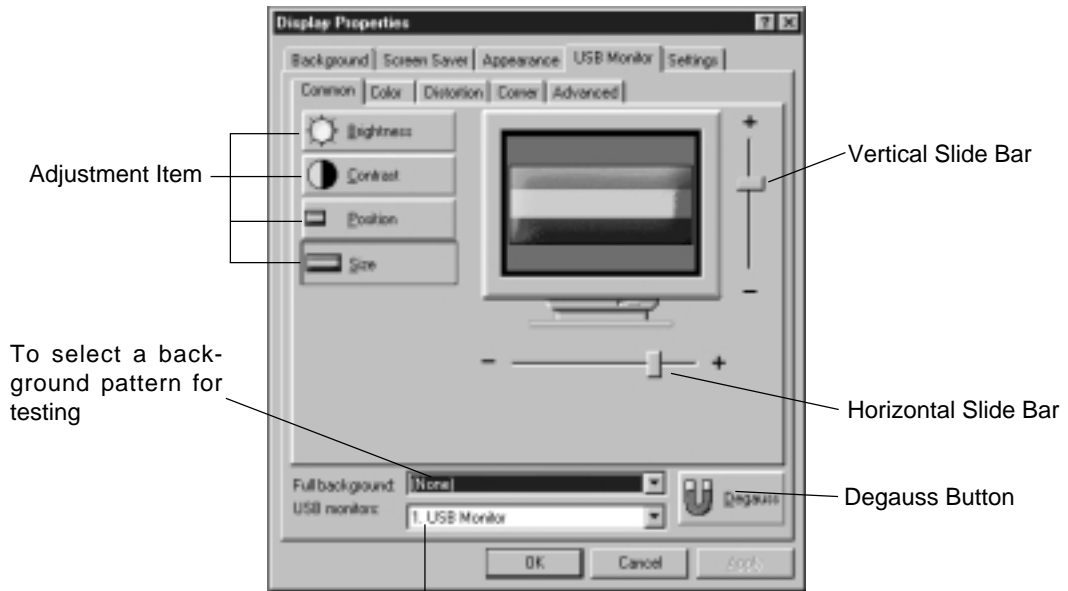

In case of connecting one or more monitors in series, you can select a monitor which you want to adjust.

- (3) Click “OK” or “APPLY” to save the new screen data.
Or click “CANCEL” or “X” button not to save. In case that “CANCEL” or “X” is clicked, the right message appears. Click “NO” to restore the old screen data.

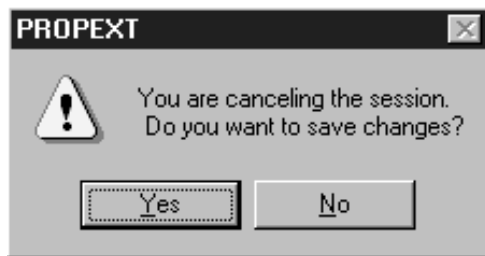

USB Monitor Control Adjustment Items and Functions

ADJUSTMENT ITEM	HORIZONTAL SLIDE BAR	VERTICAL SLIDE BAR
Brightness	Adjusts to the black level of the screen.	_____
Contrast	Adjusts to the desired contrast level.	_____
Size	Controls the horizontal size of the image.	Controls the vertical size of the image.
Position	Controls the horizontal position of the image.	Controls the vertical position of the image.
Top Corners	Adjusts the pincushioning at the top corners of the screen.	_____
Top Balance	Adjusts the curvature of the left and right sides of the screen image, near the vertical center of the screen.	_____
Bottom Corners	Adjusts the pincushioning at the bottom corners of the screen.	_____
Trapezoidal	Adjusts the parallelism of the left and right sides of the screen image.	_____
Parallelogram	Adjusts the parallelism of the left and right sides of the screen image.	_____
Pincushion	Straightens the left and right sides of the screen image.	_____
Pincushion Balance	Adjusts the curvature of the left and right sides of the screen image.	_____
Convergence	To move the red and blue to the horizontal position.	To move the red and blue to the vertical position.
Tilt	Adjusts the rotation or twist of the picture.	_____

Before calling your Authorized Product Support, please check that the items below are properly connected or set.

In case of using a non-standard signal, please check the pin assignments and the signal timing of your computer with the specification outlined in 6. SPECIFICATION and 7. APPENDIX.

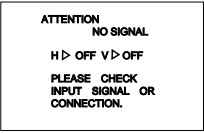
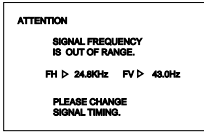
PROBLEM		ITEMS TO CHECK	LOCATION
No picture	LED On (Green)	<ul style="list-style-type: none"> Contrast and brightness controls. 	<ul style="list-style-type: none"> Front (Adjust to the maximum brightness or push the reset button)
	LED Off	<ul style="list-style-type: none"> Power switch. AC power cord disconnected. 	<ul style="list-style-type: none"> Front Rear
	LED On (Amber)	<ul style="list-style-type: none"> Signal cable disconnected. BNC cables are misconnected or the green cable is disconnected. Computer power switch. Power management function is active. 	<ul style="list-style-type: none"> Rear Check the graphics adapter and cables Computer Check the power management function.
The following message appeared. 		<ul style="list-style-type: none"> Signal cable disconnected. BNC cables are misconnected or the green cable is disconnected. Computer power switch. Power management function is active. 	<ul style="list-style-type: none"> Rear Check the graphics adapter and cables Computer Check the power management function.
The following message appeared. 		<ul style="list-style-type: none"> Input signal frequency range is disagreement. CGA MODE is not available. MDA MODE is not available. EGA MODE is not available. 	<ul style="list-style-type: none"> Check the specification of graphics adapter and monitor
Abnormal picture	Display is missing, center shifts, or too small or too large of a display size	<ul style="list-style-type: none"> Do "GEOMETRY-RESET" for a standard signal. Adjust H-SIZE, V-SIZE, H-PHASE, and V-POSITION with non-standard signals. Monitor may not be able to get full-screen image depend on signal. In this case, please select other resolution, or other vertical refresh timing. Make sure you wait a few seconds after adjusting the size of the image before changing or disconnecting the signal. 	<ul style="list-style-type: none"> Front (OSD) Front (OSD)
	Display is dark or too bright	<ul style="list-style-type: none"> Input video signal level select is not at the appropriate position for your graphics adapter output.(0.7V or 1.0Vp-p) 	<ul style="list-style-type: none"> Front (OSD)

PROBLEM	ITEMS TO CHECK	ACTION
<p>No operation of the USB devices</p>	<ul style="list-style-type: none"> • [Universal serial bus controller] is not listed in [Device Manager]. 	<ul style="list-style-type: none"> • Confirm that Windows98 is installed into the computer.
	<ul style="list-style-type: none"> • [Mitsubishi USB HUB] (or [Generic USB HUB]) is not listed in [Device Manager]. 	<ul style="list-style-type: none"> • Make sure of the cable connections. • Restart the computer. • Turn off the monitor and turn on then. • Disconnect all the cables connected to the Upstream ports and re-connect then.
	<ul style="list-style-type: none"> • On the OSD screen, the Upstream port to which the USB device you want to use is connected is not colored by blue. 	<ul style="list-style-type: none"> • Select the Upstream port by using the OSD screen, "Upstream port selection"
<p>No operation of the USB monitor control</p>	<ul style="list-style-type: none"> • [Universal serial bus controller] is not listed in [Device Manager]. 	<ul style="list-style-type: none"> • Confirm that Windows98 is installed into the computer.
	<ul style="list-style-type: none"> • [Mitsubishi USB HUB] (or [Generic USB HUB]) is not listed in [Device Manager]. Or ① mark is marked with [Mitsubishi USB HUB] (or [Generic USB HUB]) . 	<ul style="list-style-type: none"> • Make sure of the cable connections. • Restart the computer. • Turn off the monitor and turn on then. • Disconnect all the cables connected to the Upstream Port and re-connect then.
	<ul style="list-style-type: none"> • [Mitsubishi USB Monitor] (or USB Human Interface Device) is not listed in [Device Manager]. 	<ul style="list-style-type: none"> • Make sure of the cable connections. • Restart the computer. • Turn off the monitor and turn on then. • Disconnect all the cables connected to the Upstream ports and re-connect then.

PROBLEM	ITEMS TO CHECK	LOCATION
<p>Abnormal Picture</p> <p>Black vertical lines are visible on the screen.</p>	<ul style="list-style-type: none"> Thin vertical black lines on one or both sides of the screen. This minor condition is caused by grille element overlap which can occur during shipping. We suggest slapping the cabinet sides with an open hand after the monitor is warm. <p>If this fails, position an open white window over the affected area of the screen and maximize the brightness and contrast controls. This will cause localized heating of the overlap which will clear permanently in a few minutes. Be sure to readjust the brightness and contrast controls back to the normal viewing levels after this procedure.</p>	<ul style="list-style-type: none"> —
<p>Two fine horizontal lines are visible on the screen.</p>	<p>The 2 very faint thin lines across the screen are normal. They are caused by the aperture grille stabilization filaments which are required for all aperture grille CRTs'.</p>	<ul style="list-style-type: none"> —
<p>A buzzing sound when power on.</p>	<p>A brief vibration or hum sound that is heard just after power up is normal. This is caused by the automatic degaussing function. This sound will be heard each time the monitor is powered up from a cold start and each time the manual degauss button is used.</p>	<ul style="list-style-type: none"> —

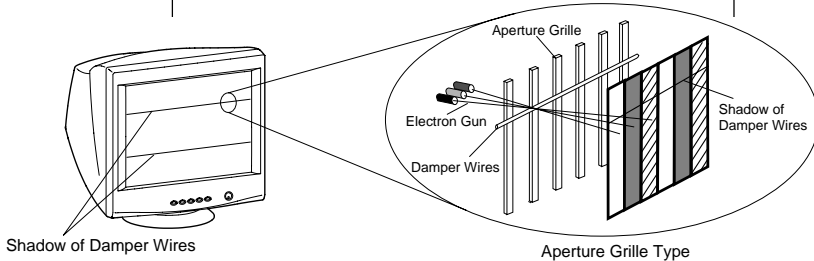
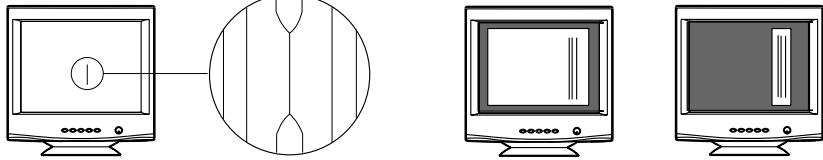

CRT	Size	50cm/19"(46cm/18" Diagonal Viewable Image)
	Mask type	Aperture grille
	Gun	In-line
	Deflection angle	90°
	Phosphors	Red, Green, Blue EBU (medium short persistence)
	Aperture grille pitch	0.25 - 0.27mm (variable)
	Face Plate	Anti-glare, Anti-reflection and Anti-static coating
	Focusing method	Dynamic Beam Forming (DBF)
INPUT SIGNAL	Video	0.7 or 1.0Vp-p analog RGB
	Sync	Sync. on Green or separated H, V sync. or Composite sync
SIGNAL INTERFACE	Input Connector	5BNC, DB9-15P
	Input Impedance	75 (video), 1k (sync.)
USB	Function	Self-powered HUB complying with Universal Serial Bus Specification Rev.1.0. USB Monitor Control to adjust the image on screen by USB commands from the computer.
	Interface	2 Upstream ports/12Mbps. 3 Downstream ports/12Mbps, 1.5Mbps, possible to supply 500mA max. per each Downstream port.
SCANNING FREQUENCY	Horizontal	30 - 95kHz
	Vertical	50 - 152Hz
RESOLUTION (HxV)	1600dots x 1200lines Non-Interlaced maximum addressable resolution format at 75Hz	
WARM-UP TIME	30 minutes to reach optimum performance level	
BRIGHTNESS	100cd/m ² , standard full white video signal at 9300K (+ 8MPCD)	
BLANKING TIME	Horizontal	___ 2.3 µsec (typ.)
	Vertical	___ 500 µsec (typ.)
DISPLAY SIZE	350mm x 262mm(typ.)	ratio 4:3
COLOR	5000K~9950K	
POWER SOURCE	AC100-120/220-240V±10% 50/60Hz 135W (typ.) <150W(max.): with USB operation>	
OPERATING ENVIRONMENT	Temperature	5 - 35°C
	Humidity	10 - 90%RH (without condensation)
CABINET	(W)17.9inch x (H)18.0inch x (D)18.0inch (W)454mm x (H)458mm x (D)456 mm	
WEIGHT	Approx. 26kg (57.3lbs.)	
TILT/SWIVEL BASE	Tilt Angle	-5° - +15°
	Swivel Angle	±90°
REGULATIONS	Safety	UL1950 (UL), CSA C22.2 No.950 (C-UL) EN60950 (TÜV-GS)
	EMC	FCC Class-B, DOC Class-B EN55022 Class-B, VCCI Class-B EN50082-1, EN61000-3-2, EN61000-3-3
	X-Ray	DHHS, HWC, Röv vom 8.1, 1987
	Other	CE-Marking, MPR-II ISO9241-3, ISO9241-7, ISO9241-8 (TÜV-ERGO) TCO '95, ZH1/618 (TÜV-GS) International ENERGY STAR Program NUTEK Spec. 803299/94 Guidelines for the Suppression of Harmonics in Appliances and General-Use Equipment

7.1 Monitor Signal Input Connector (DB9-15P)

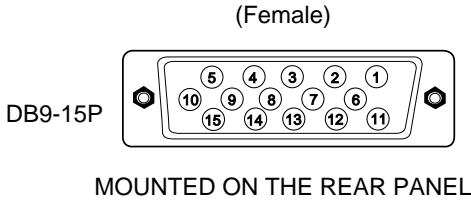

DDC DISPLAY DATA CHANNEL
 SDA SERIAL DATA
 SCL SERIAL CLOCK
 NC NO-CONNECTION

PIN ASSIGNMENTS

Pin No.	Signal
1	RED VIDEO
2	GREEN VIDEO or COMPOSITE SYNC with GREEN VIDEO
3	BLUE VIDEO
4	GROUND
5	DDC GROUND
6	RED GROUND
7	GREEN GROUND
8	BLUE GROUND
9	NC
10	SYNC GROUND
11	GROUND
12	SDA
13	HORIZONTAL SYNC or COMPOSITE SYNC
14	VERTICAL SYNC(VCLK)
15	SCL

7.2 SC-B102 Signal Cable

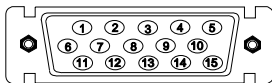
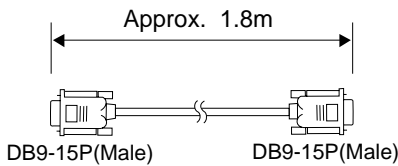

PIN ASSIGNMENTS

Pin No.	Signal
1	RED
2	GREEN
3	BLUE
4	GROUND
5	DDC GROUND
6	RED GROUND
7	GREEN GROUND
8	BLUE GROUND
9	NC
10	SYNC GROUND
11	GROUND
12	SDA
13	HORIZONTAL SYNC
14	VERTICAL SYNC(VCLK)
15	SCL

NC NO-CONNECTION
 DDC DISPLAY DATA CHANNEL
 SDA SERIAL DATA
 SCL SERIAL CLOCK

7.3 Macintosh Adapter AD-A205 settings

The AD-A205 Macintosh Adapter allows you to take an advantage of the built in video capabilities of your Macintosh computer with the monitor.

- (1) Set the dip switches of the adapter, before connect to the computer.
- (2) Set the dip switches according to the following chart.
By using the following chart, you can choose a main resolution, quickly.
If you wish to operate by other resolution, refer to next page; "AD-A205 Mac Adapter setting chart"

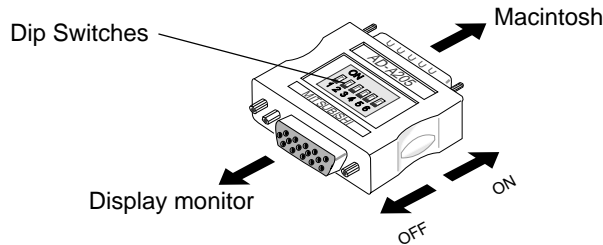

Apple Macintosh	Switch ON	Switch Setting
Macintosh IIsi, IIfx, IIfx, IIfx, LC, LC II	1,2	
Macintosh LC III, LC475, LC630	2,4	
Macintosh Quadra 610, 650, 700, 800, 840AV, 900, 950 Macintosh Centris 610, 650, 660AV	1,2,3,4	
Performa 6260, 6310, 6410, 6420 Power Macintosh 6100, 6100AV, 6200, 6300 Power Macintosh 7100AV, 7200, 7300, 7500, 7600 Power Macintosh 8100, 8100AV, 8500, 8600 Power Macintosh 9500, 9600 Workgroup Server 7350, 8150, 9150, 9650	1,2,6	
Power Macintosh 4400, G3	3,4	

- (3) "AD-A205 Mac Adapter setting chart" shows all available modes for Macintosh systems and all possible combinations with the monitor.
However, we recommend you to use the monitor with a preset timing. (See 1.2 Internal Preset Memory Capability)
 - (4) Please refer to the instruction book of your computer about the resolution setting.
Resolution may not be changed on some computers.
1. The resolution does not change with the computer powered on when you set the dip switches.
Be sure to power off the computer when you set the dip switches.
 2. Set the dip switches by a pointed article like a pencil or ball point pen to touch end of the switch groove.

< AD-A205 Mac Adapter Setting Chart >

Set the dip switch "ON" as shown below. (Example : "1,2")



解像度 (RESOLUTION)	Macintosh						Performa						Power Macintosh							
	Ilisi Ilci	Ilvi Ilvx	LC LCII	LCIII LC475	LC630	Quadra 700 900	Quadra 610 650 800 950	Quadra 840AV Centris 660AV	6260 6310	6410 6420	Workgroup Server 8150 9150	8100 VRAM Video Card (DB-15)	6200 6300	7200	4400	7300 7500 7600 8500 8600	9500	9600/233 Workgroup Server 9650	9600/300 9600/350	G3
640 x480@60Hz			3,4	3,4	3,4	3,4	3,4	3,4	1,2,6	1,2,6	3,4	3,4	1,2,6	3,4	3,4	3,4	3,4	3,4	3,4	3,4
640 x480@67Hz	1,2	1,2	1,2	1,2	1,2	1,2	1,2	1,2	1,2,6	1,2,6	1,2,6	1,2,6	1,2,6	1,2,6	1,2,6	1,2,6	1,2,6	1,2,6	1,2,6	3,4
640 x480@72Hz																				
640 x480@75Hz																				
640 x480@85Hz					3,4				1,2,6	1,2,6										
800 x600@60Hz					3,4			3,4	1,2,6	1,2,6										
800 x600@72Hz					3,4			3,4	1,2,6	1,2,6										
800 x600@75Hz																				
800 x600@85Hz																				
832 x624@75Hz			2,4	2,4	2,4	2,4	2,4	2,4	1,2,6	1,2,6	1,2,6	1,2,6	1,2,6	1,2,6	1,2,6	1,2,6	1,2,6	1,2,6	1,2,6	3,4
1024 x768@60Hz								3,4	1,2,6											
1024 x768@72Hz								3,4			3,4									
1024 x768@75Hz									1,2,6											
1024 x768@85Hz											1,2,6									
1024 x768@85Hz																				
1152 x870@75Hz					1,2,3,4	1,2,3,4	1,2,3,4	1,2,3,4			1,2,6									
1280 x960@60Hz																				
1280 x960@75Hz																				
1280 x960@85Hz																				
1280 x1024@60Hz																				
1280 x1024@75Hz																				
1280 x1024@85Hz																				
1600 x1200@60Hz																				
1600 x1200@65Hz																				
1600 x1200@67Hz																				
1600 x1200@70Hz																				
1600 x1200@75Hz																				

CP871C146C10