

# AST-3G™ Model 1

**AST**  
RESEARCH INC.

*Enhanced Graphics Adapter  
(EGA) Providing High-Resolution,  
Full-Spectrum Color Graphics  
And High-Quality Text Capabil-  
ities For The IBM® PC/XT/AT  
And Compatibles*

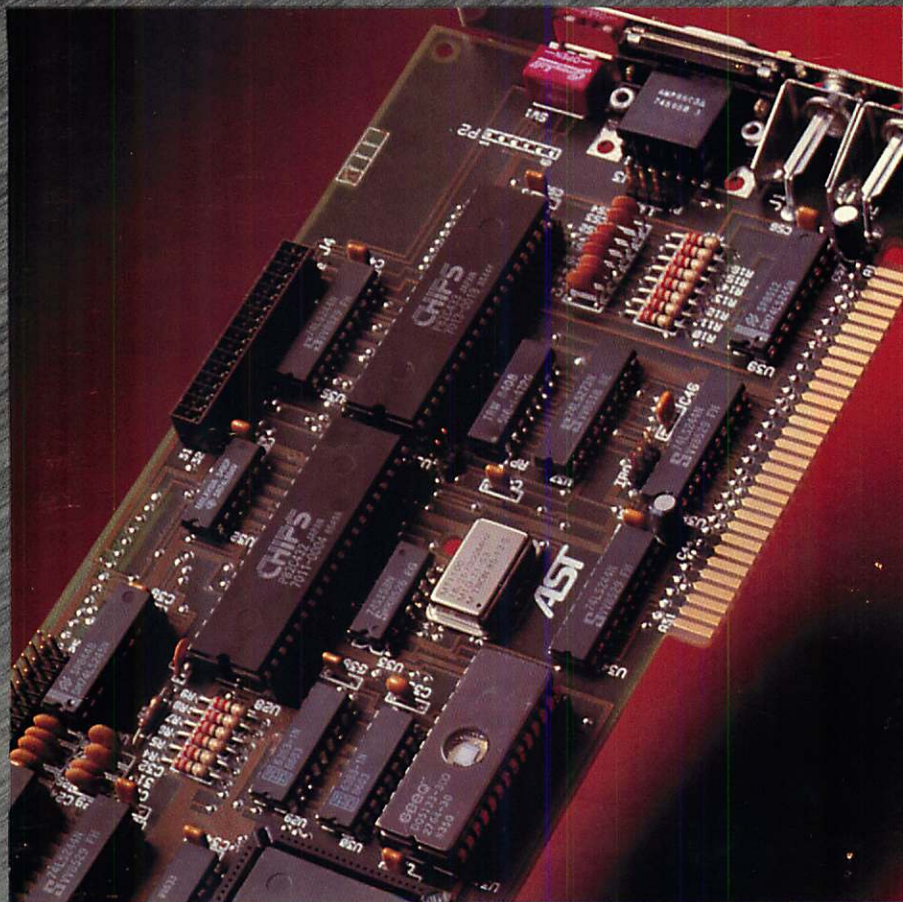

*User's Manual*

**AST-3G™ Model 1**  
**Enhanced Graphics Adapter**  
**for the**  
**IBM Personal Computer,**  
**IBM PC-XT, PC-AT,**  
**And Other**  
**IBM-Compatible Machines**

User's Manual  
000337-001 A  
March 1986

**AST Research, Inc.**  
**Irvine, California**  
**(714) 863-1333**

First Edition (March 1986)

AST-3G Model 1, SixPakPlus, MonoGraphPlus, Preview!, and Advantage! are trademarks of AST Research, Inc.

IBM is a registered trademark of International Business Machines Corporation.

Changes are periodically made to the information contained in this manual; these changes will be incorporated into new editions.

In view of demonstrated product reliability and comprehensive warranty policies, AST Research, Inc. does not normally provide schematics or material lists. AST recognizes that some customers with a large installed base of AST products want supportive documentation for their own service organizations. In such cases, customers should contact AST Research corporate offices to consider an appropriate nondisclosure agreement to obtain this documentation.

A Product Comment Form is provided at the back of this publication. If this form has been removed, please address your comments to: AST Research, Inc., Attn: Product Marketing, 2121 Alton Ave., Irvine, CA 92714. AST Research may use or distribute any of the information you supply in any way it deems appropriate without incurring any obligations whatsoever.

Copyright© 1986 AST Research, Inc. All rights are reserved, including those to reproduce this book or parts thereof in any form without permission in writing from AST Research, Inc.

#### **WARNING**

This manual is protected by United States Copyright law (Title 17 United States Code). Unauthorized reproduction and/or sales may result in imprisonment of up to one year and fines of up to \$10,000 (17 USC 506). Copyright infringers may be subject to civil liability.

# TABLE OF CONTENTS

<b>SECTION 1. INTRODUCTION</b> .....	1-1
1.1 Checklist .....	1-2
1.2 Compatibility and System Requirements .....	1-3
1.3 How to Use This Manual .....	1-4
1.3.1 Related Documentation .....	1-4
1.3.2 Manual Outline .....	1-4
<b>SECTION 2. OVERVIEW</b> .....	2-1
2.1 Some Terms You Should Know .....	2-1
2.2 Versatility of the AST-3G Graphics Display Adapter ..	2-2
2.3 Monitor and Display Adapter Compatibility .....	2-2
2.3.1 IBM 5151 Monochrome Display Monitor .....	2-4
2.3.2 IBM 5153 Color Display Monitor .....	2-4
2.3.3 IBM 5154 Enhanced Color Display Monitor ..	2-5
2.4 Software/Hardware Compatibility Limitations with AST-3G .....	2-5
2.5 Using Multiple Display Adapters .....	2-6
<b>SECTION 3. CONFIGURATION AND INSTALLATION</b> .....	3-1
3.1 AST-3G Default Configuration .....	3-2
3.2 Changing the Default SW1 Configuration .....	3-4
3.3 Changing the Monitor Select Jumper Block .....	3-5
3.4 Configuring the Parallel Port .....	3-6
3.5 Installing Your AST-3G .....	3-9
<b>SECTION 4. PARALLEL PORT</b> .....	4-1
4.1 I/O Address and Interrupt Assignments .....	4-1
4.2 Parallel Port Pinout Specifications .....	4-2
4.3 Configuring External Parallel Devices .....	4-3
4.4 Programming the Parallel Port .....	4-3

# TABLE OF CONTENTS

(Continued)

4.5	Interrupt-Driven Parallel Printer Software	4-4
4.6	Parallel Port Diagnostic Testing	4-4
<b>SECTION 5. DIAGNOSTICS</b>		<b>5-1</b>
5.1	Starting the Diagnostics Program	5-2
5.2	The Configuration Screen	5-2
5.3	The Test Screens	5-3
5.3.1	Monochrome Display Tests	5-4
5.3.2	Color Display Tests	5-10
5.3.3	Enhanced Color Display Tests	5-17
<b>SECTION 6. PRODUCT REPAIR PROCEDURE</b>		<b>6-1</b>
<b>SECTION 7. ENHANCEMENT OPTIONS</b>		<b>7-1</b>
7.1	Installing the Memory Upgrade Kit	7-1
7.2	Installing the Parallel Port Upgrade Kit	7-4
<b>APPENDIX A. FEATURE CONNECTOR</b>		<b>A-1</b>
<b>APPENDIX B. LIGHT PEN INTERFACE</b>		<b>B-1</b>

## Figures

Figure 3-1.	Installation Overview	3-1
Figure 3-2.	AST-3G Model 1 Display Adapter Layout (Default Configuration)	3-2
Figure 3-3.	SW1 Switch Block Default Configuration	3-5
Figure 3-4.	Monitor Selection Jumper Block	3-6
Figure 3-5.	Removing the PC Cover	3-10
Figure 3-6.	Removing the PC-AT Cover	3-11
Figure 3-7.	Switch Block 1 on the PC and PC-XT	3-12
Figure 3-8.	Parallel Port Ribbon Cable and Bracket	3-13
Figure 3-9.	Installing Ribbon Cable on the AST-3G	3-13
Figure 3-10.	Installing the Plastic Card Guide	3-14
Figure 3-11.	Installing the AST-3G Adapter	3-15

# TABLE OF CONTENTS

(Continued)

Figure 5-1.	Configuration Screen . . . . .	5-2
Figure 5-2.	Monochrome Text Attributes Test (Blinking) . . . . .	5-4
Figure 5-3.	Monochrome Text Attributes Test (Intensified) . . . . .	5-5
Figure 5-4.	Monochrome Character Set Test (9 × 14 pixel character box) . . . . .	5-6
Figure 5-5.	Monochrome Character Set Test (8 × 8 pixel character box) . . . . .	5-7
Figure 5-6.	Monochrome Memory Pages Test . . . . .	5-8
Figure 5-7.	Monochrome Intensity Test . . . . .	5-9
Figure 5-8.	Color Text Attributes Test (Blinking) . . . . .	5-10
Figure 5-9.	Color Text Attributes Test (Intensified) . . . . .	5-11
Figure 5-10.	Color Character Set Test, 40-Column Wide Format . . . . .	5-12
Figure 5-11.	Color Character Set Test, 80-Column Wide Format . . . . .	5-13
Figure 5-12.	Color Memory Pages Test . . . . .	5-14
Figure 5-13.	Color 320 × 200 4-Color Graphics Test . . . . .	5-15
Figure 5-14.	Color 640 × 200 2-Color Graphics Test . . . . .	5-16
Figure 5-15.	Enhanced Text Attributes Test (Blinking) . . . . .	5-17
Figure 5-16.	Enhanced Text Attributes Test (Intensified) . . . . .	5-18
Figure 5-17.	Enhanced Character Set Test (8 × 8 pixel characters, 40 columns) . . . . .	5-19
Figure 5-18.	Enhanced Character Set Test (8 × 14 pixel characters, 80 columns) . . . . .	5-20
Figure 5-19.	Enhanced Character Set Test (8 × 8 pixel characters, 43 Rows) . . . . .	5-21
Figure 5-20.	Enhanced Memory Pages Test . . . . .	5-22
Figure 5-21.	Enhanced 320 × 200 4-Color Graphics Test . . . . .	5-23
Figure 5-22.	Enhanced 640 × 200 2-Color Graphics Test . . . . .	5-24
Figure 5-23.	Enhanced 640 × 350, Primary Colors Test . . . . .	5-25

# TABLE OF CONTENTS

(Continued)

Figure 7-1. AST-3G Adapter Upgrade Chip Placement . . . . 7-2

Figure A-1. Feature Connector Layout . . . . . A-3

Figure B-1 Light Pen Interface Connector . . . . . B-1

## Tables

Table 2-1. AST-3G Graphics Modes . . . . . 2-3

Table 2-2. AST-3G Model 1 Text Modes . . . . . 2-4

Table 3-1. AST-3G Model 1 Default Configuration . . . . . 3-3

Table 3-2. SW1 Switch Settings . . . . . 3-4

Table 3-3. Parallel Port I/O Assignments  
Without Port on Another Display Card  
Fixed as LPT1 . . . . . 3-7

Table 3-4. Parallel Port I/O Assignments  
With Port on Another Display Card  
Fixed as LPT1 . . . . . 3-7

Table 3-5. Parallel Port Configuration  
(Without Port on Another Display Card  
Fixed as LPT1) . . . . . 3-8

Table 3-6. Parallel Port Configuration  
(With Port on Another Display Card  
Fixed as LPT1) . . . . . 3-9

Table 4-1. PC Parallel Port I/O & IRQ Assignments  
(With Port on another Display Card  
Fixed as LPT1) . . . . . 4-2

Table 4-2. PC Parallel Port I/O & IRQ Assignments  
(Without Port on Another Display Card  
Fixed as LPT1) . . . . . 4-2

Table 4-3. DB25S Parallel Port Pinouts . . . . . 4-3

Table A-1. Feature Connector Inputs and Outputs . . . . . A-2

Table B-1 Light Pen Interface Pinouts . . . . . B-1

# SECTION 1

## INTRODUCTION

The AST-3G™ Model 1 graphics display adapter (hereafter referred to as AST-3G) provides advanced color and high-resolution graphics capabilities for the IBM® Personal Computer (PC), PC-XT, PC-AT, and most IBM-compatibles. AST-3G, AST's third generation graphics product, is extremely versatile because it is compatible with all IBM PC display monitors (and equivalents), and can perform the functions of three IBM display adapters.

AST-3G comes equipped with either 64 or 256 kilobytes (KB) of memory, so that it is not necessary to acquire any supplemental memory to use the AST-3G card. AST-3G features include:

- Compatibility with three types of IBM monitor:
  - IBM 5151 Monochrome Display (MD).
  - IBM 5153 Color Display (CD).
  - IBM 5154 Enhanced Color Display (ECD).
- Performs the functions of three IBM display adapter cards:
  - IBM Monochrome Display and Printer Adapter (MDA).
  - IBM Color/Graphics Adapter (CGA) with some limitations. (Refer to Section 2.4).
  - IBM Enhanced Graphics Adapter (EGA).
- Can coexist with either the MDA or CGA.
- Using MDA capabilities, provides 640 x 350 pixel monochrome graphics with a 9 x 14 pixel character box for text.



- Using CGA capabilities, provides 640 x 200 and 320 x 200 pixel resolutions, and 16-color graphics.
- Using EGA capabilities, provides 640 x 350 pixel resolution, with use of 16 colors simultaneously from a color palette of up to 64 different colors.
- Random access memory (RAM)-based, loadable character generator capable of generating up to 512 displayable characters for use in any application (such as scientific notation and foreign language characters).
- Supports up to 43 lines of 80-column text.
- Provides smooth, flicker-free horizontal and vertical scrolling.
- 256 KB of on-board graphics memory supports up to eight graphics pages in 320 x 200 pixel, 16-color mode.
- Designed using advanced VLSI technology for speed, reliability, and compatibility.
- Provides a feature connector, light pen interface, and an optional parallel port.

## 1.1 Checklist

Before getting started, check that your AST-3G Model 1 package includes the following items:

- AST-3G graphics adapter.
- *AST-3G User's Manual*.
- AST-3G diagnostics diskette.

Two optional upgrade packages are available for your AST-3G Model 1 adapter:

- AST-3G Model 1 Memory Enhancement Kit (Part Number 500305-006).
- AST-3G Model 1 Parallel Port Enhancement Kit (Part Number 500305-005).

## 1.2 Compatibility and System Requirements

The minimum hardware requirements for operation with AST-3G are:

- An AST-3G board with 64 KB. To utilize fully the capabilities of AST-3G, the recommended amount of on-board graphics memory is 256 KB.
- An IBM PC, PC-XT, PC-AT, or IBM-compatible with one floppy diskette drive and an unused full-length expansion slot.
- One of the following types of monitor is necessary
  - An IBM 5154 Enhanced Color Display or 350-line, 64-color RGB/R'G'B<sup>2</sup>-compatible.
  - An IBM 5153 Color Display or 200-line, 16-color RGBI-compatible.
  - An IBM 5151 Monochrome Display or compatible TTL monochrome monitor.

The AST-3G diagnostics software is compatible with DOS 2.0 or later, or an MS-DOS equivalent.

If the ROM BIOS (Read Only Memory Basic Input Output System) module in your PC or PC-XT is earlier than 10/27/82, you must have the new ROM module installed in your PC before you can use AST-3G. The first screen of the diagnostics program displays the date of the ROM module in your PC system, as described in Section 5. It is not necessary to check for this with the PC-AT.

## 1.3 How to Use this Manual

This section provides a list of related documentation and an outline of the manual.

### 1.3.1 Related Documentation

You may find it useful to have the following documents for reference:

- *IBM Disk Operating System (DOS) Manual.*
- *IBM PC Guide to Operations.*
- *IBM PC Technical Reference Manual.*
- *IBM PC-AT Guide to Operations.*
- *IBM PC-AT Technical Reference Manual.*
- *IBM PC-AT Installation and Setup Manual.*

#### NOTE

If you need AST-3G Model 1 programming information, call AST Technical Support for details.

### 1.3.2 Manual Outline

#### **SECTION 1: INTRODUCTION**

Describes the features of AST-3G, and provides information on system requirements, and related documentation.

#### **SECTION 2: OVERVIEW**

Provides a detailed description of how AST-3G functions with different monitor types. Also describes the different graphics adapters the AST-3G can simulate and coexist with in one system.

***SECTION 3: CONFIGURATION AND INSTALLATION***

Includes instructions on setting AST-3G adapter switches and PC system switches, and a series of steps to install AST-3G in your PC.

***SECTION 4: PARALLEL PORT***

Describes the AST-3G parallel printer port in detail.

***SECTION 5: DIAGNOSTICS***

Tells you how to use the diagnostics program that comes with AST-3G.

***SECTION 6: PRODUCT REPAIR PROCEDURE***

Describes the product repair procedure to follow if your AST-3G ever needs repair.

***SECTION 7: ENHANCEMENT OPTIONS***

Describes how to install the memory and parallel port upgrade kits for your AST-3G.

***APPENDIX A: FEATURE CONNECTOR***

Describes the AST-3G feature connector in detail.

***APPENDIX B: LIGHT PEN INTERFACE***

Describes the AST-3G light pen interface.

(This page intentionally left blank)

# SECTION 2

## OVERVIEW

This section provides an overview of the different combinations of adapters and monitors you can choose from when using an AST-3G graphics display adapter. Once you have determined which combination of adapters and monitor you will be using, you can configure and install your AST-3G adapter as described in Section 3 of this manual.

### 2.1 Some Terms You Should Know

The following definitions describe terms used throughout this manual.

#### **Bit Map**

A computer representation that defines the color and intensity of each pixel on a raster screen required to create an image.

#### **Font**

A master from which type is created, including any and all characters designed to be used together that are of a particular typeface (such as helvetica bold).

#### **Pixels**

The smallest unit available for display on a raster screen, representing a single graphics point. Also called picture elements.

#### **Raster display**

The predominant type of CRT display. It operates similarly to an ordinary television set whereby images are created by illuminating individual pixels via a line-by-line scan of the CRT screen by an electron beam.

## **Resolution**

The number of pixels displayed on a monitor per horizontal line, by the number of horizontal lines displayed on the vertical axis (for example, 640 x 350 indicates 640 pixels wide by 350 lines of pixels vertically).

## **VDI (Virtual Device Interface)**

A software interface method that allows applications programs to be written independent of graphics hardware.

## **2.2 Versatility of the AST-3G Graphics Display Adapter**

AST-3G is a versatile graphics display adapter that is compatible with three types of IBM monitor and three IBM display adapters. Many IBM-compatible monitors and adapters are also compatible with AST-3G. The graphics capabilities available with AST-3G, including resolution and number of colors, vary depending on what monitor type is used and which display adapter you wish to simulate.

The capabilities of AST-3G may be affected when other graphics display adapters are installed in your system. The graphics features of specific applications software packages may also be affected by the monitor and adapter configuration of your AST-3G.

## **2.3 Monitor and Display Adapter Compatibility**

The AST-3G can be used with several IBM monitors and display adapters:

- 5151 Monochrome Display (MD) designed for use with the Monochrome Display Adapter (MDA) (Section 2.3.1)

- 5153 Color Display (CD) designed for use with the Color/Graphics Adapter (CGA) (Section 2.3.2).
- 5154 Enhanced Color Display (ECD) designed for use with the Enhanced Graphics Adapter (EGA) (Section 2.3.3).

Tables 2-1 and 2-2 summarize all possible adapter/monitor combinations, and the resulting graphics and text capabilities or modes. These modes are determined by the software package and display monitor that you are using with your AST-3G adapter.

**Table 2-1. AST-3G Graphics Modes.**

<b>Adapter AST-3G Simulates (1)</b>	<b>Number of Colors</b>	<b>Memory Pages (Max.)</b>	<b>Resolution (h x v)</b>	<b>Monitor Required (2)</b>
EGA	16/64(3)	2	640 x 350	ECD
EGA	16	4	640 x 200	CD,ECD
EGA	16	8	320 x 200	CD,ECD
EGA	4/64	1	640 x 350	ECD
EGA	2 (4)	2	640 x 350	MD
CGA	4	1	320 x 200	CD/ECD
CGA	2	1	320 x 200	CD/ECD
CGA	2	1	640 x 200	CD/ECD

**NOTES FOR TABLES 2-1 and 2-2**

(1) EGA = Enhanced Graphics Adapter, CGA = Color Graphics Adapter, MDA = Monochrome Display and Printer Adapter

(2) ECD = IBM 5154 Enhanced Color Display Monitor, CD = IBM 5153 Color Display Monitor, MD = IBM 5151 Monochrome Display Monitor.

(3) 16 displayable colors with a 64-color palette to choose from. Requires 256 KB of on-board graphics memory.

(4) Also includes blink and high-intensity attributes.



**Table 2-2. AST-3G Model 1 Text Modes.**

Adapter AST-3G Simulates(1)	Number of Colors	Pages (Max.)	Character Size (pixels)	Characters per screen	Monitor Needed(2)
EGA	16/64 (3)	2	8 × 14	80 × 25	ECD
EGA	16/64 (3)	8	8 × 8	80 × 43	ECD
CGA/EGA	16	8	8 × 8	80 × 25	CD/ECD
CGA/EGA	16	8	8 × 8	40 × 25	CD/ECD
CGA/EGA	2	8	8 × 8	80 × 25	CD/ECD
CGA/EGA	2	8	8 × 8	40 × 25	CD/ECD
MDA/EGA	2	4	9 × 8	80 × 43	MD
MDA/EGA	2	8	9 × 14	80 × 25	MD

Descriptions follow of each type of IBM monitor. Some information is also included about the type of graphics adapter most often used with that monitor.

**2.3.1 IBM 5151 Monochrome Display Monitor**

The IBM 5151 Monochrome Display was designed to be used with the IBM MDA. The MD monitor has a screen refresh rate of 50 Hz (non-interlaced), and a maximum bandwidth of 16.257 MHz. The MD monitor is transistor-transistor logic (TTL) compatible and has a horizontal scan frequency of 18.432 KHz.

**2.3.2 IBM 5153 Color Display Monitor**

The IBM 5153 Color Display was designed to work with the IBM CGA. The CD monitor can display up to 16 different colors, by combining digital outputs of red, green, blue and intensity values. Monitors of this type are called Digital RGB monitors because they combine the pure colors red, green and blue to create color variations. The CD monitor has a high-contrast black screen. There are many IBM-compatible Digital RGB monitors; however, some of them provide only 8 colors instead of 16.

The maximum bandwidth of the CD monitor is 14.318 MHz. The screen refresh rate is 60 Hz (non-interlaced). The CD is TTL-compatible, with a horizontal scan frequency of 15.750 KHz.

### **2.3.3 IBM 5154 Enhanced Color Display Monitor**

The IBM 5154 Enhanced Color Display (ECD) was designed to take advantage of the unique capabilities of the Enhanced Graphics Adapter (EGA). The ECD monitor is extremely versatile in that it can support software written for either the EGA or the CGA. For the ECD monitor, the screen refresh rate is 60 Hz. The horizontal scan rate can be either 15.75 KHz or 21.850 KHz. This monitor is considered to be an RGBI monitor because each color can be intensified respectively.

#### **NOTE**

If you are planning to use an AST-3G Model 1 graphics display adapter with a new Enhanced Color Display, be sure to get a demonstration of that monitor with the AST-3G display adapter and appropriate EGA software, to ensure that it provides the capabilities you are looking for.

## **2.4 Software/Hardware Compatibility Limitations with AST-3G**

AST-3G is fully compatible with IBM's Enhanced Graphics Adapter (EGA). As a result of this, AST-3G is among the devices supported by the Virtual Device Interface (VDI) as described by IBM and Graphics Software Systems (GSS). Any software written employing the VDI interface will run on AST-3G with an EGA driver.

CGA software that runs on IBM's EGA will also run on AST-3G.

## 2.5 Using Multiple Display Adapters

You may wish to install your AST-3G in your computer and use it in one of the operating modes described in Tables 2-1 and 2-2. However, depending on your software applications, you may wish to install your AST-3G along with another coexisting display adapter.

The AST-3G can only be used with another display adapter if one adapter is operating in a color mode, and the other is in a monochrome mode. For example, if an AST-3G coexists with a CGA, then the AST-3G must be configured in monochrome mode because the CGA is only capable of operating in a color mode. Likewise, if an AST-3G coexists with an MDA, then the AST-3G must be set up as a color adapter since the other adapter is for monochrome only.

Two coexisting adapters cannot be configured as the same type of adapter—for example, an AST-3G adapter cannot emulate an MDA when another MDA is coexisting. The combinations of display adapters which are *not* possible include the following:

- AST-3G with AST-3G.
- AST-3G with EGA.
- AST-3G (in any color mode) with CGA.

When two display adapter cards do coexist, you must specify which adapter is “primary” and which is “secondary”. This is accomplished through switch settings on the AST-3G, which are described in Section 3. The adapter designated as primary will be the adapter in use when you boot up your system; the secondary card will not be used unless it is activated through a DOS MODE command.

For example, to switch over to a monochrome display adapter designated as secondary from a different primary card, you would enter the following command at the DOS prompt:

```
A>MODE MONO <Enter>
```

Conversely, to switch over to a color display adapter designated as secondary from a different primary display adapter, you would enter the following command at the DOS prompt:

**A>MODE C080 <Enter>**

For further information, refer to your *DOS manual* (DOS 2.0 and above).

(This page intentionally left blank)

# SECTION 3

## CONFIGURATION AND INSTALLATION

Figure 3-1 is an overview of the steps needed to configure and install your AST-3G display adapter.

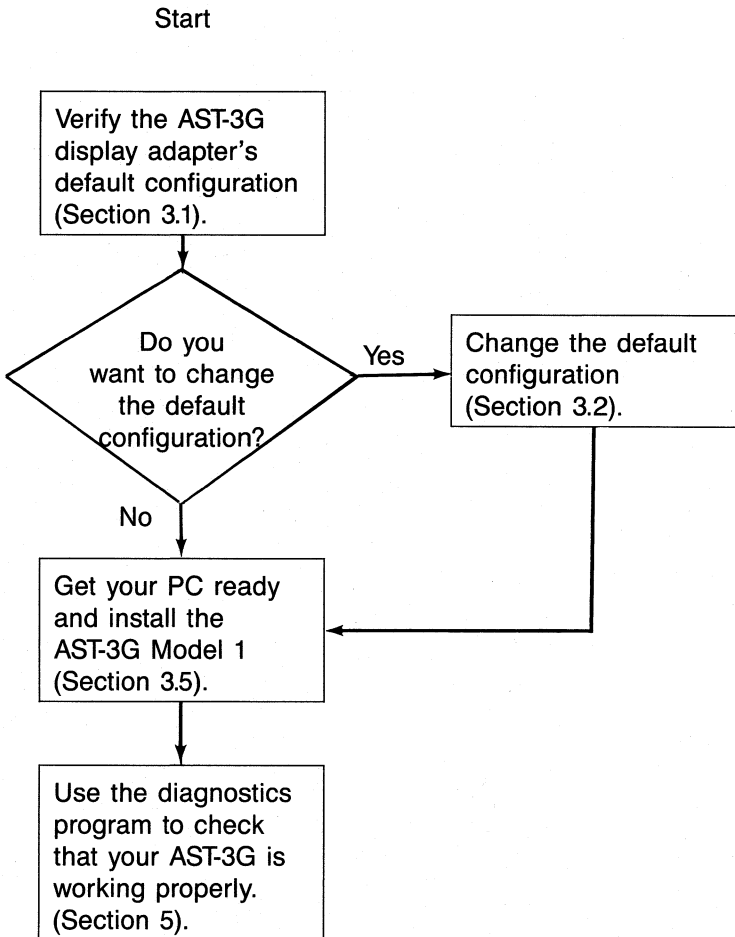

**Figure 3-1. Installation Overview.**

### 3.1 AST-3G Default Configuration

Figure 3-2 shows the default factory configuration of the AST-3G display adapter.

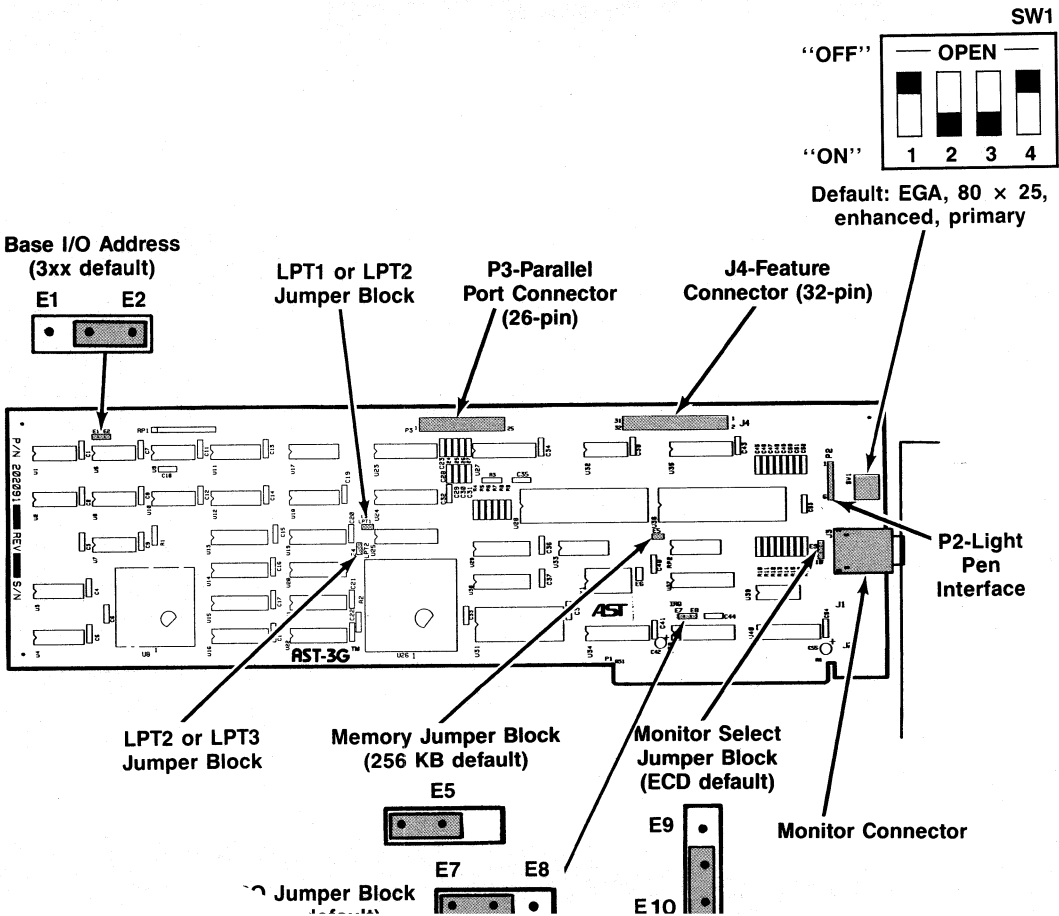

Figure 3-2. AST-3G Model 1 Display Adapter Layout (Default Configuration).

Table 3-1 summarizes the AST-3G adapter's default factory configuration.

**Table 3-1. AST-3G Model 1 Default Configuration**

Parameter	Default	Comments
Card Type, Mode, Monitor, Primary	EGA, 80 x 25 text, ECD monitor, Primary. (SW1-1 OFF, SW1-2 ON, SW1-3 ON, SW1-4 OFF.)	The SW1 switch block provides the power-up graphics configuration for the AST-3G. Refer to Table 3-2 for all the possible switch settings and configurations.
Monitor Type	ECD monitor. (Plug at jumper block position E10.)	This jumper block indicates the type of monitor in use. If a monitor other than an ECD is used, move plug to position E9.
AST-3G on-board graphics memory.	Either 64 KB or 256 KB. (Plug at jumper block position E5 for 256, no plug for 64.)	The default setting for memory varies depending on whether your AST-3G board has 64 KB or 256 KB. You only need to change the default setting if you are upgrading from 64 KB to 256 KB.
Parallel Port	LPT1 at IRQ7. (Plug at jumper block LPT1, and at position 7 on the IRQ jumper block.)	This setting identified the parallel port and specifies a hardware interrupt number. You may need to change these settings if there is another parallel port installed in your PC.
Base I/O Address	3xx. (Plug at jumper block E2.)	The base I/O address is used for PC to AST-3G communication. You only need to change it if you are planning to install 2 AST-3G display adapters in a PC. Changing this will lessen software compatibility.



### 3.2 Changing the Default SW1 Configuration

A four-position Dual In-line Package (DIP) switch (SW1) is located on the rear of the AST-3G display adapter, accessible either before you install the adapter or through a cutout in the I/O panel at the back of your system once the adapter is installed.

The SW1 switch block configuration determines what monitor is to be used, what display adapter mode of operation is desired at the time your system powers up, and whether the AST-3G is to be the primary or secondary system display. Your system will always power up in text mode, using the configuration you have selected with the SW1 switch. However, the applications software you run on your system can change the AST-3G configuration to a graphics mode, or to another text mode.

Table 3-2 shows all the acceptable switch settings for SW1, and how they affect AST-3G configuration at power-up time. Figure 3-3 shows the switch block.

**Table 3-2. SW1 Switch Settings.**

SW1 Switch Block Settings				Monitor Type	AST-3G Primary Display	AST-3G Operating, Power-Up Modes	Second Adapter, Mode
1	2	3	4				
*OFF	ON	ON	OFF	ECD	Yes	EGA, 80x25	MDA, 80x25
**ON	ON	ON	OFF	CD/ECD	Yes	CGA, 80x25	MDA, 80x25
OFF	OFF	OFF	ON	CD/ECD	Yes	CGA, 80x25	MDA, 80x25
ON	OFF	OFF	ON	CD/ECD	Yes	CGA, 40x25	MDA, 80x25
OFF	OFF	ON	OFF	MD	Yes	MDA, 80x25	CGA, 80x25
ON	OFF	ON	OFF	MD	Yes	MDA, 80x25	CGA, 40x25
OFF	OFF	ON	ON	ECD	No	EGA, 80x25	MDA, 80x25
**ON	OFF	ON	ON	CD/ECD	No	CGA, 80x25	MDA, 80x25
OFF	ON	ON	ON	CD/ECD	No	CGA, 80x25	MDA, 80x25
ON	ON	ON	ON	CD/ECD	No	CGA, 40x25	MDA, 80x25
OFF	ON	OFF	ON	MD	No	MDA, 80x25	CGA, 80x25
ON	ON	OFF	ON	MD	No	MDA, 80x25	CGA, 40x25

\*default setting

\*\* features enhance character set

The abbreviations and terms used in Table 3-2 are as follows:

MD — Monochrome Display Monitor  
 CD — Color Display Monitor  
 ECD — Enhanced Color Display Monitor

MDA — Monochrome Display Adapter  
 CGA — Color/Graphics Adapter  
 EGA — Enhanced Graphics Adapter

40 x 25 — Text display 40 columns horizontally by 25 rows vertically.

80 x 25 — Text display 80 columns horizontally by 25 rows vertically.

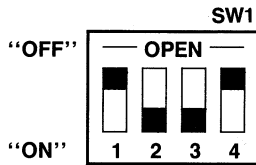

**Figure 3-3. SW1 Switch Block Default Configuration.**

### 3.3 Changing the Monitor Select Jumper Block

If your monitor is a different type from the ECD monitor, such as the CD or MD monitor, move the plug from position 10 on this jumper block to position 9. Figure 3-4 shows the default and alternate configurations.

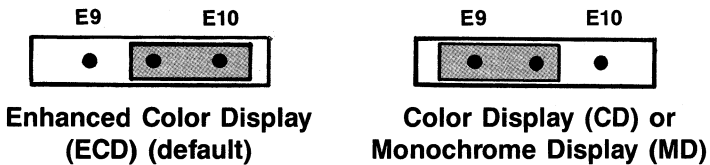

**Figure 3-4. Monitor Selection Jumper Block.**

### CAUTION

It is extremely important to set this this jumper block correctly, since incorrect setting of the jumper block could damage your monitor.

## 3.4 Configuring the Parallel Port

DOS will support up to three parallel printer ports, called LPT1, LPT2, and LPT3. In most configurations, the AST-3G parallel port can respond only as LPT1 or LPT2. However, in certain multiple port configurations, AST-3G can respond as LPT3. The port can also be disabled. The default configuration of your AST-3G parallel port is LPT1. (If another parallel port fixed as LPT1 is already present, the AST-3G port will respond as LPT2.)

The switch settings on the AST-3G adapter used for configuring the parallel port indicate a hardware I/O address by means of which the computer communicates with that port. There are two settings, which usually correspond to LPT1 and LPT2.

Certain display adapters, such as the IBM MDA, have a parallel port that is assigned to a third address, which is always fixed as LPT1. When a board of this type is present, the two switch settings on the AST-3G correspond to LPT2 or LPT3. Tables 3-3 and 3-4 show the I/O addresses and labels in these two situations.

**Table 3-3. Parallel Port I/O Assignments without Port on Another Display Card Fixed as LPT1.**

Port	I/O Address	Port Location
LPT1	378-37A hex	AST-3G.
LPT2	278-27A hex	AST-3G.

**Table 3-4. Parallel Port I/O Assignments with Port on Another Display Card Fixed as LPT1.**

Port	I/O Address	Port Location
LPT1	3BC-3BE Hex	Display Card.
LPT2	378-37A Hex	AST-3G.
LPT3	278-27A Hex	AST-3G.

### Installing Multiple Parallel Ports

Your PC may already have another card with a parallel port on it configured to respond as LPT1, such as an AST Research Advantage!™ card. If so, then you must change either the other card or the AST-3G to respond as LPT2 (this avoids conflicts between the two ports).

If a display card with a port fixed as LPT1 is also present, then the AST-3G port and one other port can be configured to respond as LPT2 and LPT3.

If your PC system has a display card without a built-in parallel port fixed as LPT1 (responding to I/O address 3BC-3BE hexadecimal), then use Table 3-5 to configure the parallel port. If your PC system has a video display card with a built-in printer adapter port (such as the IBM MDA), then use Table 3-6 to configure the parallel port.

**Table 3-5. Parallel Port Configuration (Without Port on Another Display Card Fixed as LPT1).**

Number of Parallel Ports Already in the PC System	Parallel Port Configuration	AST-3G Parallel Port Functions
0	LPT1 at IRQ7 (Default).	LPT1 — Place plug at LPT1. IRQ7 — Place plug at position 7 on the IRQ block (Default Setting).
1	LPT2 at IRQ7 (PC) or IRQ5 (PC-AT).	LPT2 — Move plug from LPT1 to LPT2. IRQ7 for the PC. For the PC-AT, use IRQ5 — Move plug from position 7 to position 8 on the IRQ jumper block.
2 or 3	Disabled.	* Disabled. Remove plugs from LPT1, LPT2, and the IRQ jumper block.

\* LPT3 is not supported in this situation.

**Table 3-6. Parallel Port Configuration (With Port on Another Display Card Fixed as LPT1).**

Number of Parallel Ports Already in The PC (with a Port Fixed as LPT1)	Parallel Port Configuration	AST-3G Parallel Port Functions
1	LPT2 at IRQ7 (Default).	LPT2 — Place plug at LPT1. The port will respond as LPT2. (Default.) IRQ7 — Place plug on pins 2 and 3 of the IRQ jumper block. (Default.)
2	LPT3 at IRQ7 (PC) or IRQ5 (PC-AT).	LPT3 — Move plug from LPT1 to LPT2. The port will respond as LPT3. IRQ7 for the PC. For the PC-AT, use IRQ5 — move plug from E7 to E8 on the IRQ block.*
3	Disabled	Disabled. Remove plugs from LPT1, LPT2, and the IRQ jumper block.

\* Assumes a display adapter with a port fixed as LPT1 is present, and another port is configured to respond as LPT2.

### 3.5 Installing Your AST-3G

Before installing your AST-3G adapter, you must turn off your PC, disconnect any device attached to it, and remove the PC cover. This section includes procedures for the PC, PC-XT, and PC-AT. Differences for the PC-AT are noted at the end of each installation step.

### CAUTION

Be sure that the power switch is off and the power cord is removed from the system unit. Turn off any other equipment connected to the computer. Installing any component while the power is on can permanently damage your computer and its components.

You will need a flathead screwdriver or nut driver to perform the following procedure.

#### STEP 1

*Remove the PC cover:* Use a flathead screwdriver or nut driver to remove the cover mounting screws from your PC (see your PC's manual for the location of the cover mounting screws). Once you have removed the cover mounting screws, pull the PC cover off as shown in Figure 3-5.

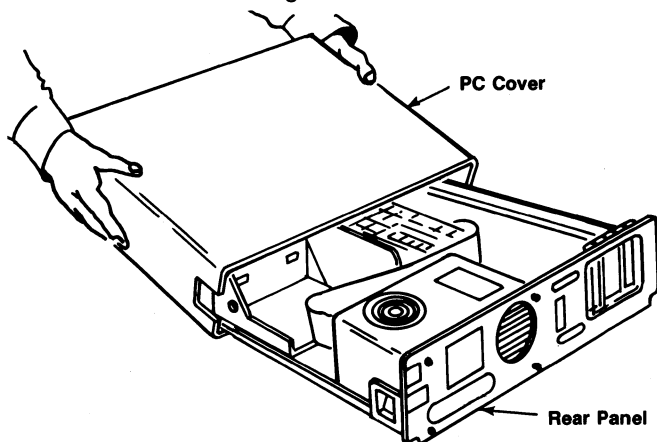

**Figure 3-5. Removing the PC Cover.**

*For the PC-AT,* unlock the key lock at the front of the PC-AT by turning the key counterclockwise. Remove the back panel (which is attached to the PC-AT with plastic fastener strips) from the rear of the PC-AT. Use a flathead screwdriver or nut driver to remove the cover mounting screws. Slide the cover toward the front until it comes off, as shown in Figure 3-6.

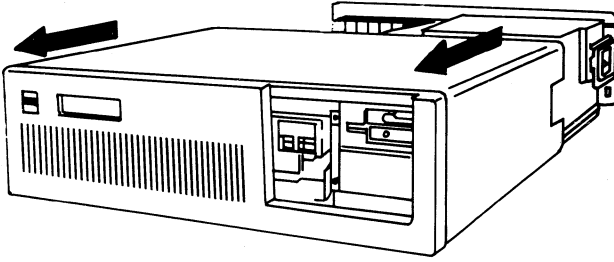

**Figure 3.6. Removing the PC-AT Cover.**

## **STEP 2**

*Set PC or PC-XT system board Switch Block 1:* Locate switch block SW1 on the main circuit board of the PC or PC-XT (the PC-XT has only one system board switch block). Set switches SW1-5 and SW1-6 to ON (on the eight-switch block). Also, check for the correct setting of switch SW1-2. If an 8087 coprocessor is installed, switch SW1-2 must be OFF. Otherwise, it must be ON. Figure 3-7 shows the location of SW1 on the PC and PC-XT.

*For the PC-AT,* you will need to run the SETUP program once your system is powered up again after AST-3G Model 1 has been installed (see STEP 11).



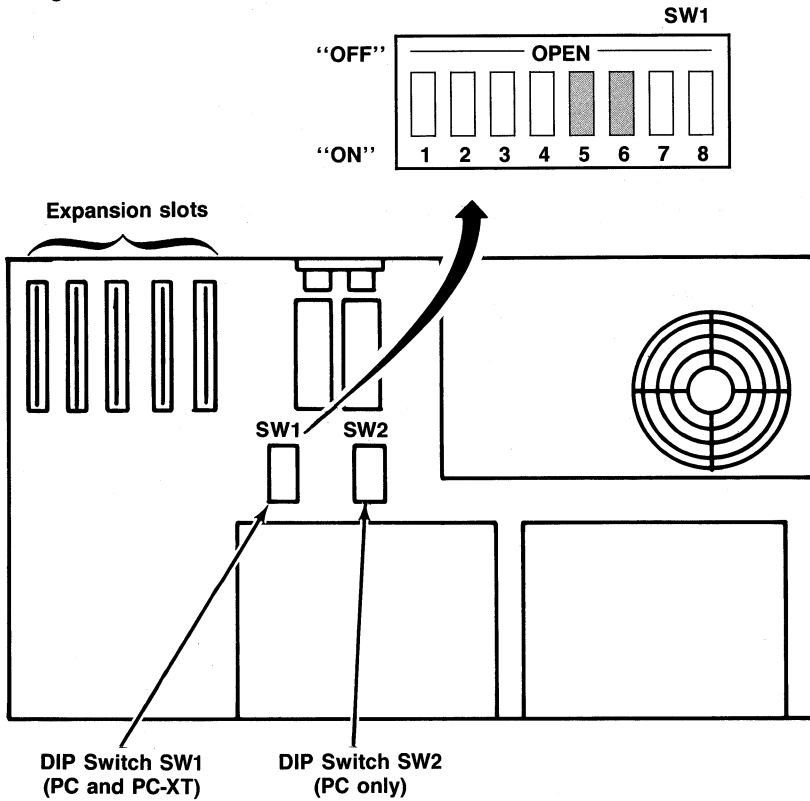

Figure 3-7. Switch Block 1 on the PC and PC-XT.

**STEP 3**

*Install ribbon cable on the AST-3G:* This step is necessary only if you intend to use the parallel port. If not, proceed to STEP 4.

Locate the ribbon cable for the parallel port. The parallel port ribbon cable has a rectangular 26-pin connector at one end and a DB25S connector at the other end.

The ribbon cable comes with a bracket. Using the hardware supplied on the D-shell connector, mount the D-shell connector to the bracket so that when the bracket is installed, the D-shell connector will be accessible at the PC's rear panel. The ribbon cable and bracket for the parallel port are shown in Figure 3-8.

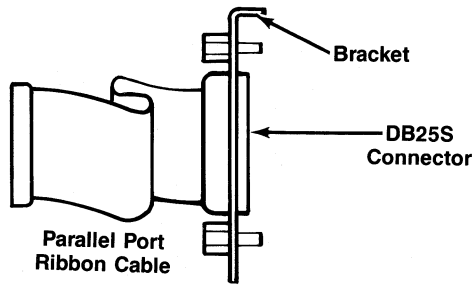

**Figure 3-8. Parallel Port Ribbon Cable and Bracket.**

Plug the parallel adapter cable onto connector P3 on the AST-3G. Plug the cable onto the board so that pin 1 on the rectangular connector (indicated by an arrow and the red or blue stripe on the ribbon cable) aligns with pin 1 on the P3 connector (silkscreened in white on the circuit board).

Figure 3-9 shows the parallel port cable installed on the AST-3G.

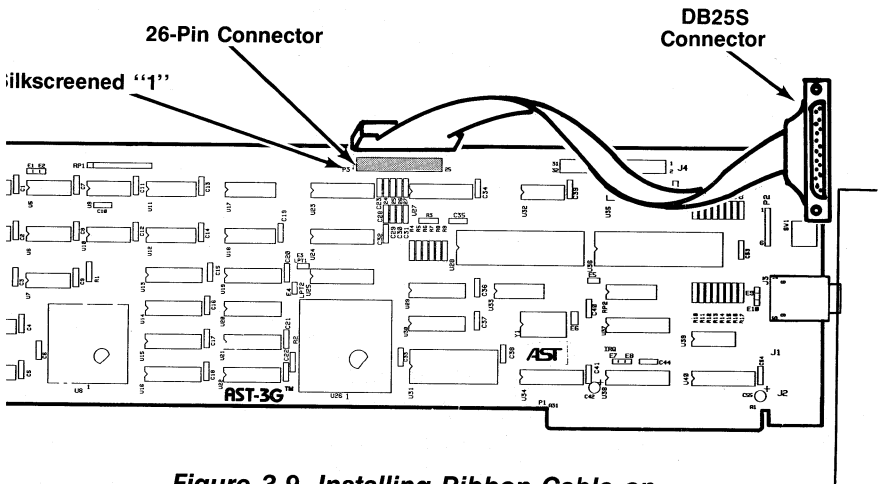

**Figure 3-9. Installing Ribbon Cable on AST-3G.**

#### STEP 4

*Select an open expansion slot:* The AST-3G adapter requires one full-length slot. Remove the expansion slot cover and locate the metal cover for the cut-out in the back panel of the PC system chassis for the slot that you have selected. Remove and save the bracket retaining screw using a small flathead screwdriver. Remove the expansion slot cover.

#### STEP 5

*Install the card guide:* This step is only necessary in a PC or PC-XT. If you have a PC-AT, go to STEP 6. Install the plastic card guide supplied with the AST-3G (if one is not already installed) on the inside front panel of the PC for the slot that will hold your AST-3G adapter (Figure 3-10).

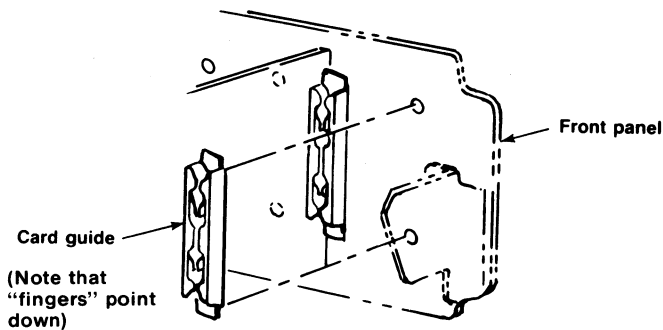

**Figure 3-10. Installing the Plastic Card Guide.**

#### STEP 6

*Install the AST-3G adapter:* Line up the AST-3G adapter and position its front bottom corner in the card guide channel. Position any wires or ribbon cables so they will pass either beneath or above the installed card and will not be damaged during installation. Lower the board until its edge connector is resting on the expansion slot receptacle. Using an evenly distributed pressure, press the AST-3G adapter straight down until it seats in the expansion slot (Figure 3-11).

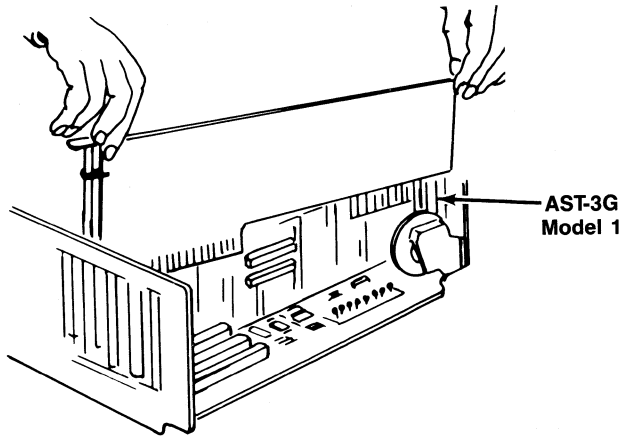

**Figure 3-11. Installing the AST-3G Adapter.**

**STEP 7**

*Secure the card to the rear of the PC system chassis:* Use the screw you removed from the expansion slot cover in STEP 5.

**STEP 8**

*Replace PC cover:* Carefully slide the cover from the front until it stops securely against the rear panel. Reinstall the cover mounting screws you removed earlier.

*For the PC-AT,* slide the cover from the front until it stops securely against the rear panel, reinstall the cover mounting screws, and press the back panel so that the plastic fastener strips secure it in place.

**STEP 9**

*Install Cables:* Replace the power cord to the system unit and be sure that the keyboard and the monitor connectors are plugged in. Reattach any other cables (including the printer cable to your new printer port), and connectors you removed previously.

**STEP 10**

*Attach the display monitor cable to the AST-3G:* The cable from the display monitor should be plugged in to the AST-3G's connector.

**STEP 11**

*Now you are ready to power up:* On the PC-AT, run the SETUP program. Instead of setting hardware switches on the main system board for the PC-AT, you will need to run the SETUP program provided on the IBM PC-AT Diagnostics diskette. SETUP is a menu-driven program that allows you to configure your PC-AT for the type of graphics card you will be using. Check your *PC-AT Guide to Operations* manual for full instructions on using SETUP.

## SECTION 4

# PARALLEL PORT

The parallel ports in the PC provide one-way communication (output only) between the PC and parallel peripheral devices such as printers or plotters. Data is sent from the PC to the external device eight bits (one byte) at a time. A PC running under DOS will support up to three parallel ports. These ports are referred to as LPT1, LPT2, and LPT3 (some IBM manuals also call the default port “PRN”). These are the only parallel ports DOS can access.

The AST-3G Model 1 graphics display adapter can be equipped with one parallel port as an optional feature (available at the time of purchase or by means of the Parallel Port Enhancement Kit). When the PC is also equipped with a display card that has a parallel port fixed as LPT1, the AST-3G parallel port can respond as LPT2 or LPT3. Otherwise, the AST-3G parallel port can respond only as LPT1 or LPT2 (refer to Section 3.4).

### 4.1 I/O Address and Interrupt Assignments

The parallel ports supported by the Disk Operating System (DOS) in the PC are assigned the hardware I/O address and interrupt request (IRQ) lines as summarized in Table 4-1 (with port on another display card fixed as LPT1) and Table 4-2 (without a port on another display card fixed as LPT1).

**Table 4-1. PC Parallel Port I/O & IRQ Assignments (With Port on Another Display Card Fixed as LPT1).**

AST-3G Switch Setting	Port	I/O Address	IRQ Line used	Port Location
N/A	LPT1	3BC-3BE Hex	IRQ7	Display Card
LPT1	LPT2	378-37A Hex	IRQ5 or IRQ7**	AST-3G
LPT2	LPT3	278-27A Hex	Not Supported*	AST-3G

\* Interrupt-driven I/O for LPT3 is not supported in the PC.  
 \*\* IRQ5 on the PC-AT, IRQ7 on PC or PC-XT.

**Table 4-2. PC Parallel Port I/O & IRQ Assignments (Without Port on Another Display Card Fixed as LPT1).**

AST-3G Port & Switch Setting	I/O Address	IRQ Line Used	Port Location
LPT1	378-37A Hex	IRQ7	AST-3G
LPT2	278-27A Hex	IRQ5 or IRQ7*	AST-3G
LPT3	← LPT3 Not Supported →		

\*IRQ5 on the PC-AT, IRQ7 on the PC or PC-XT.

The AST-3G Model 1 conforms to these standards and uses identical I/O and IRQ assignments.

## 4.2 Parallel Port Pinout Specifications

The parallel ports in the PC and on the AST-3G use a DB25S (socket) interface connector. The pinouts for all the parallel ports are identical and are shown in Table 4-3.

**Table 4-3. DB25S Parallel Port Pinouts.**

Line Name	AST Adapter Cable Output DB25S	IBM Matrix Printer Centronics Interface
-STROBE	1	1
D0	2	2
D1	3	3
D2	4	4
D3	5	5
D4	6	6
D5	7	7
D6	8	8
D7	9	9
-ACK	10	10
BUSY	11	11
PE	12	12
SLCT	13	13
-AUTOFD	14	14
-ERROR	15	32
-INIT	16	31
-SLCT IN	17	36
GROUND	(18-24)	(16,19-30,33)

### 4.3 Configuring External Parallel Devices

Whenever you connect a new device to your computer such as a parallel printer, you may also have to perform a one-time configuration of that device to establish desired operating parameters. This is usually done by setting switches in the device. Refer to the installation manual supplied with the device for further information on its configuration requirements.

### 4.4 Programming the Parallel Port

Normally no special action is necessary to prepare the parallel ports for use. However, you can use the DOS MODE command to establish certain parameters such as line width. Consult the *DOS Manual* for information on this command.

The AST-3G parallel port is completely compatible with all PC software operating parameters.



## 4.5 Interrupt-Driven Parallel Printer Software

Interrupt-driven parallel printer software uses IRQ7. To ensure that your interrupt-driven parallel printer software operates correctly, you must leave IRQ7 enabled on the AST-3G (the default), by leaving a shorting plug on jumper E7. It will not harm anything to leave IRQ7 enabled even if you do not run interrupt-driven software for your parallel printer.

## 4.6 Parallel Port Diagnostic Testing

The parallel port on your AST-3G is completely compatible with the IBM Diagnostics software. However, you must configure the parallel port as LPT1 so that the port can be recognized by the diagnostics.

If you run the matrix printer test, your printer must be 100% compatible with an Epson MX-80™ or errors can be generated.

## SECTION 5

# DIAGNOSTICS

A diagnostics program is provided with your AST-3G Model 1 graphics display adapter. This program allows you to check the current configuration of your AST-3G adapter, and to determine if all the graphics capabilities of your AST-3G are working as they should be.

The diagnostics program is a series of screens to test the different graphics capabilities of the AST-3G. There are three sets of screens that will be presented, depending on whether you have a Monochrome Display (MD), a Color Display (CD), or an Enhanced Color Display (ECD) attached to the AST-3G.

After an initial configuration screen, each screen presented will test a particular aspect of the AST-3G's capabilities. At the bottom of each screen is a prompt telling you how to proceed to the next step. Generally, you will need to press the  key (<Enter> key) to proceed to the next screen or test, or <Esc> to quit the program.

If a labeled region on one of the test screens displays a different color or mode from its label, then proceed through the following steps:

- If two areas labeled with different intensities appear the same, adjust the brightness and contrast controls to see if this increases intensity differences.
- Check your SW1 switch settings and Monitor Selection jumper block settings to be sure that they match your configuration (refer to Section 3 for information on configuring your AST-3G.)

Call AST Research Technical Support if there are still problems with the diagnostics displays.

## 5.1 Starting the Diagnostics Program

To initiate the Diagnostics program, type in the following command at the DOS prompt:

A<DIAG<Enter>

After this command is entered, the diagnostics program will present either an error message indicating that no AST-3G Model 1 card is present, or a configuration screen listing the basic configuration of the AST-3G display adapter.

## 5.2 The Configuration Screen

For *all* AST-3G Model 1 configurations, the diagnostics program presents as its first screen a configuration screen that allows you to check whether your AST-3G Model 1 is configured properly. A sample configuration screen for a monochrome monitor and the AST-3G Model 1 adapter follows:

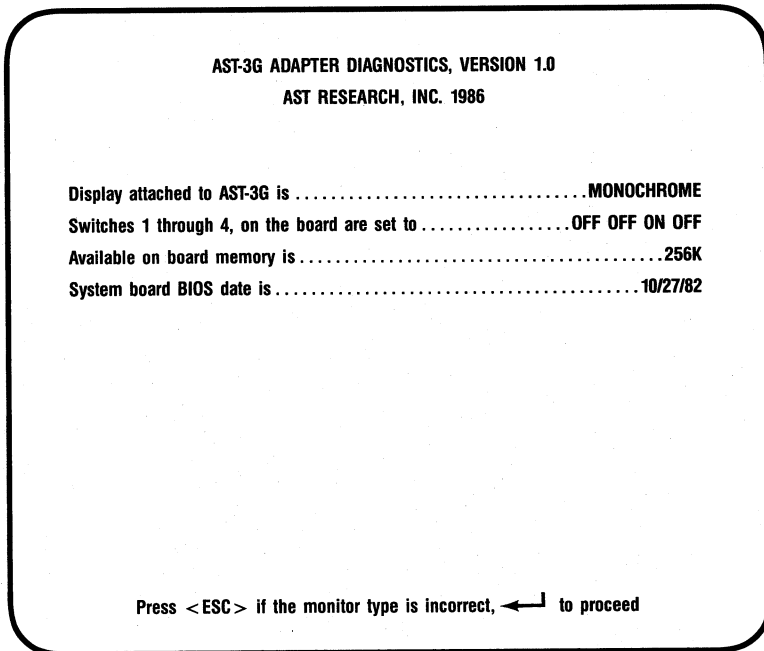

Figure 5-1. Configuration Screen.

### *Display Type*

The choices for the Display type are MONOCHROME, COLOR, and ENHANCED (corresponding to the MD, CD, or ECD monitor). *If the value shown is not accurate, then your SW1 switch settings probably are wrong.* Table 3-2 shows all the SW1 switch settings and their corresponding configurations.

### *SW1 Switch Settings*

The values shown for Switches 1 through 4 should display how the SW1 switches are set. If they are not set correctly for the configuration you wish, then exit the program and change your switch settings (the SW1 switch is accessible at the back of your PC system).

### *Memory on AST-3G Model 1 Graphics Display Adapter*

Available on-board memory displays the amount of memory available on the AST-3G Model 1. This should be either 64 KB or 256 KB.

### *ROM BIOS date*

The mother board BIOS date shows the date of the ROM module in your PC system. If this date is earlier than 10/27/82, then you need to have the new ROM BIOS installed in your PC system. The date will be displayed even if the AST-3G is not present in the system. Thus you can check the BIOS date *before* you install the AST-3G.

## **5.3 The Test Screens**

Three sets of diagnostics tests are provided with AST-3G. One set is used for each type of monitor—the Monochrome Display (MD), the Color Display (CD), and the Enhanced Color Display (ECD). In the following sections, a description of each test is given, followed by a sample screen. If the screen is malfunctioning it may need repairs, or incorrect SW1 switch settings or jumper settings may be indicated.

### 5.3.1 Monochrome Display Tests

#### M1 — Monochrome Display Test

Sixteen background text attributes and sixteen foreground text attributes are shown in labeled rectangles. Each rectangle tests a different attribute, although some are labeled the same. Some attributes can be displayed in intensified or blinking. To switch between the two, press the <SPACE> bar.

**TEST M1: TEXT ATTRIBUTES**

<b>BACKGROUND SHADES</b> (Black text)	<b>TEXT SHADES</b> (Black background)
Black	Black
Normal	Normal Underlined
Normal	Normal
Normal	Normal
Normal	Normal
Normal	Normal
Normal	Normal
Normal	Normal
Black	Black
Blinking	Intensified Underlined
Blinking	Intensified
Blinking	Intensified
Blinking	Intensified
Blinking	Intensified
Blinking	Intensified
Blinking	Intensified

Press  for next test, <ESC> to quit, <SPACE> to toggle blink/intensify

Figure 5-2. Monochrome Text Attributes Test (Blinking).



**Figure 5-3. Monochrome Text Attributes Test (Intensified).**



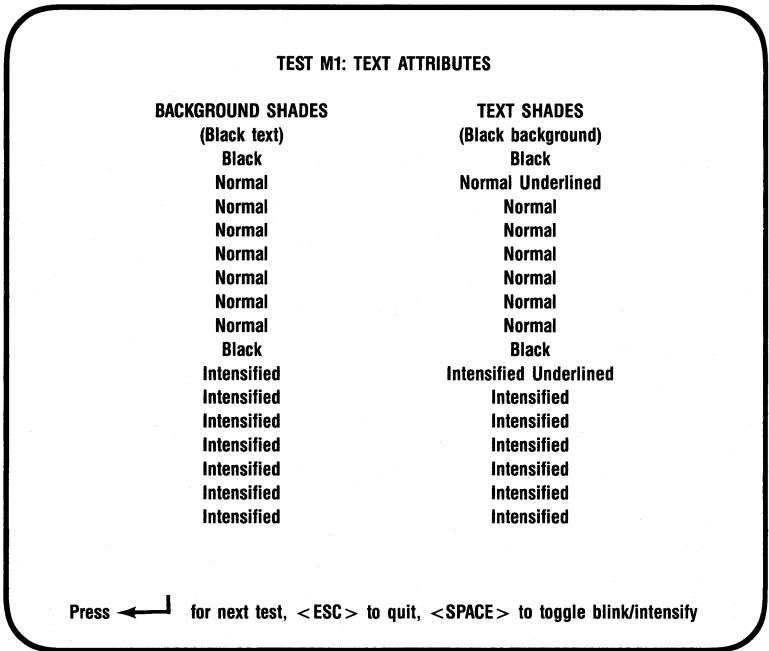



**M4 — Paged Memory Display Test**

This screen shows the pages of memory available in your PC. There should be four pages available if you have 64 KB of memory, and eight pages if you have 256 KB of memory. You can traverse through the pages by pressing the space bar. The background of the screen is made up of the number of the page, from 1 to 8.

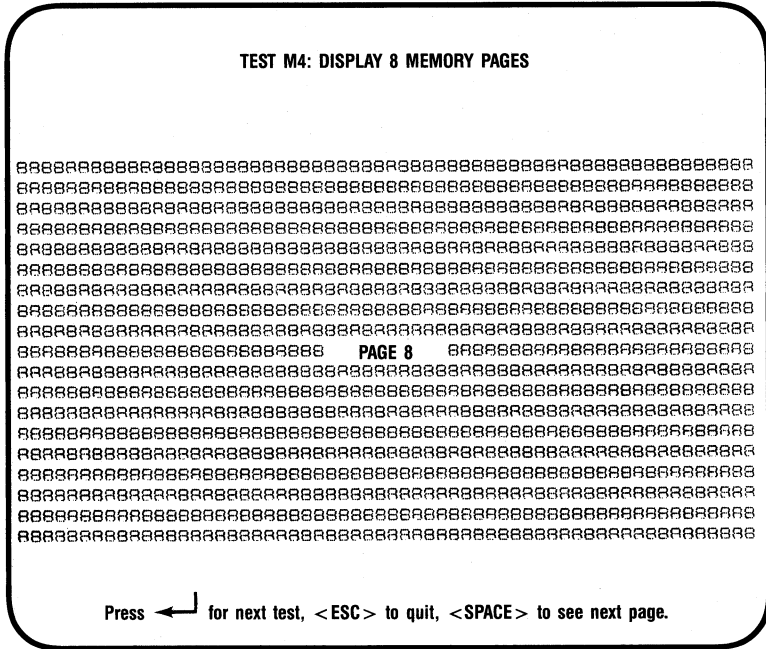

**Figure 5-6. Monochrome Memory Pages Test.**

**M5 — 640 x 350 Resolution Monochrome Graphics Intensity Test**

This screen shows four different intensities available for graphics with an AST-3G, black, normal, intensified, or blinking. If normal and intensified appear the same, adjust the contrast on your monitor. The intensities should all appear different.

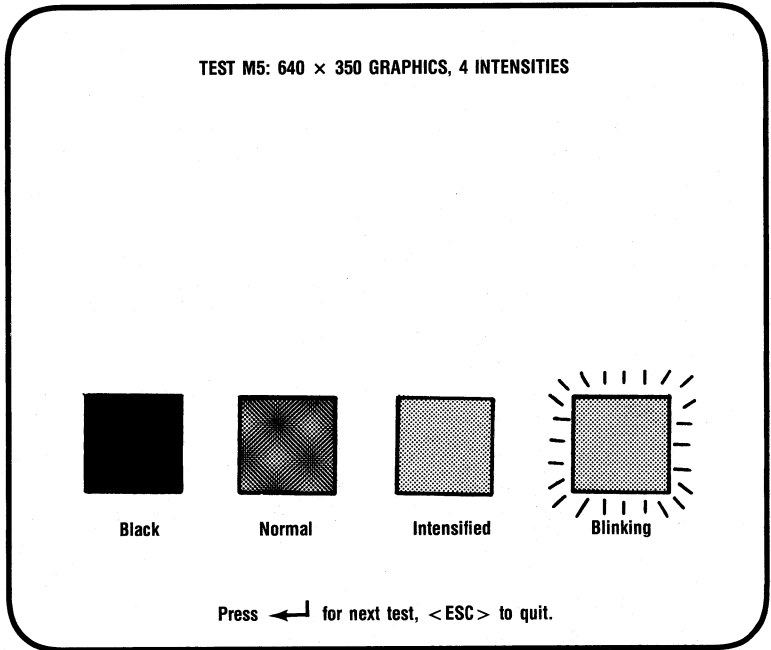

**Figure 5-7. Monochrome Intensity Test.**

### 5.3.2 Color Display Tests

If you are using a CD monitor, you will be presented with a set of tests designed for this configuration, as follows.

#### C1 — Text Attributes Test

This screen displays text and background using 16 different colors. Each field is labeled with the name of the color that is meant to appear there. The sixteen text colors are shown on the right, using colored letters against a black background. On the left, the 16 colors are shown and are labeled with black letters. The second half of the background colors can be either intensified or blinking. To switch between the two, press the <SPACE> bar.

**TEST C1: TEXT ATTRIBUTES**

BACKGROUND COLORS (Black text)	TEXT COLORS (Black background)
Black	Black
Blue	Blue
Green	Green
Cyan	Cyan
Red	Red
Magenta	Magenta
Brown	Brown
Gray	Gray
Black	Dark Gray
Blinking Blue	Light Blue
Blinking Green	Light Green
Blinking Cyan	Light Cyan
Blinking Red	Light Red
Blinking Magenta	Light Magenta
Blinking Brown	Yellow
Blinking Gray	White

Press for next test, <ESC> to quit, <SPACE> to toggle blink/intensify

**Figure 5-8. Color Text Attributes Test  
(Blinking).**

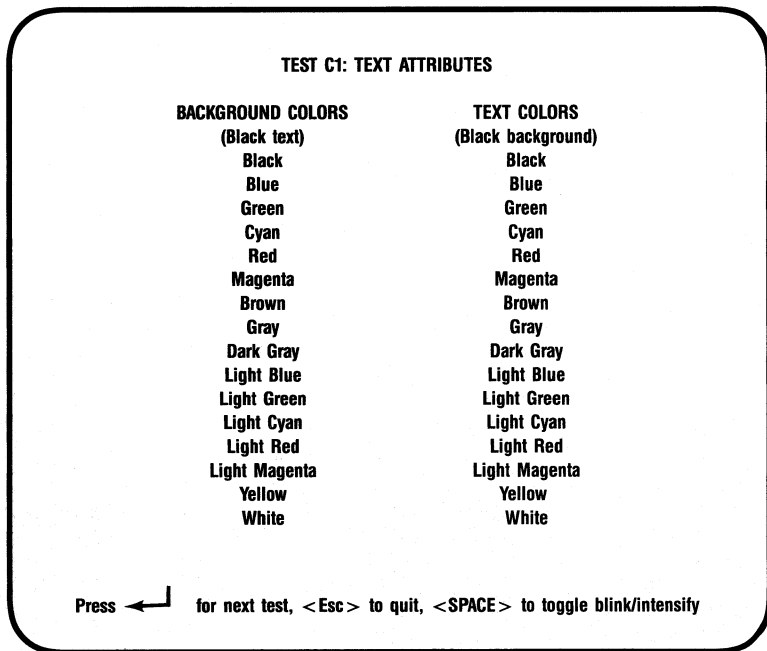

**Figure 5-9. Color Text Attributes Test  
(Intensified).**

*C2 and C3 — Color Character Set Tests*

These two screens display the available character set; C2 shows the characters in a 40-column wide screen, and C3 shows them in an 80-column wide screen.

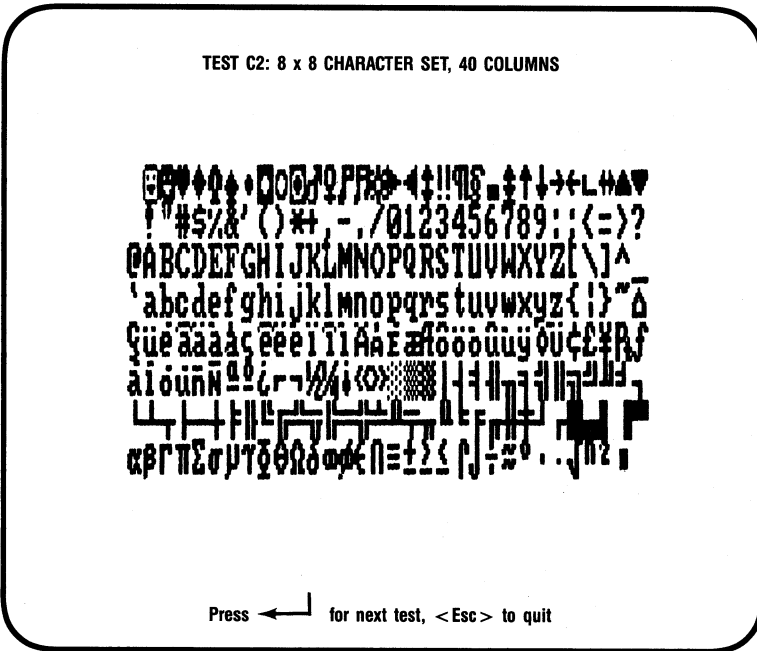

**Figure 5-10. Color Character Set Test,  
40-Column Wide Format.**





**C5 — 320 x 200 Resolution Graphics, 4 Colors**

This screen shows the four basic color components that provide the colors for this configuration: black, blue, green, and red. These colors are shown in 4 rectangular boxes. The colors of the boxes should match their labels.

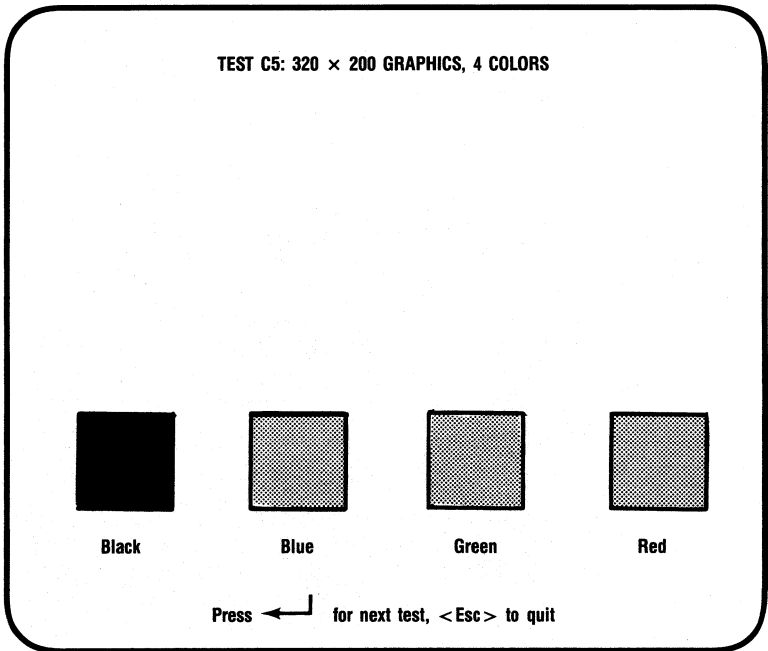
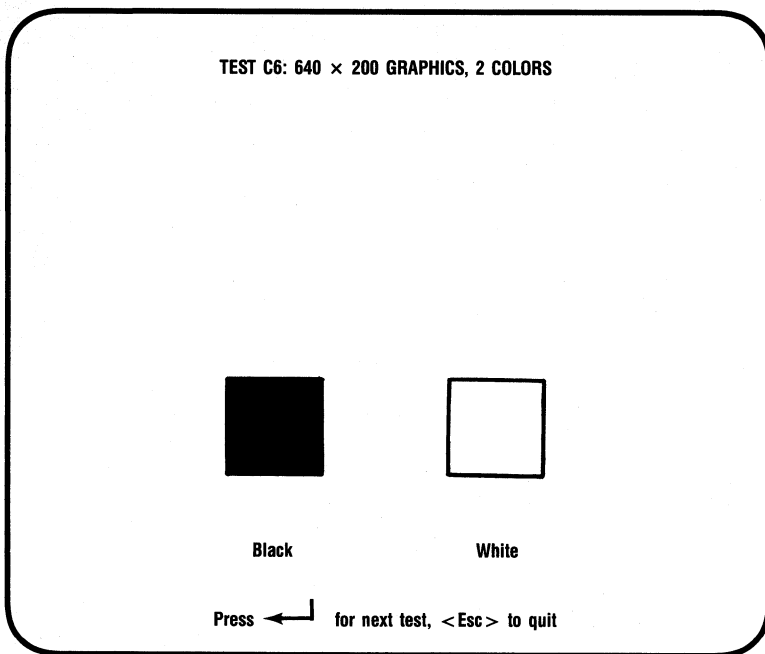

**Figure 5-13. Color 320 x 200, 4-Color Graphics Test.**



**C6 — 640 x 200 Resolution Graphics, 2 Colors**

This screen displays the colors black and white in rectangular boxes. The colors of the boxes should match their labels.



**Figure 5-14. Color 640x200 2-Color Graphics.**

### 5.3.3 Enhanced Color Display Tests

If you are using an ECD monitor, you will be presented with a set of tests designed for this configuration, as follows:

#### E1 — Text Attribute Tests

This screen displays text and background using 16 different colors. Each field is labeled with the name of the color that is meant to appear there. The sixteen text colors are shown on the right, using colored letters against a black background. On the left, the 16 colors are shown and are labeled with black letters. The second half of the background colors can be either intensified or blinking. To switch between the two, press the <SPACE> bar.

TEST E1: TEXT ATTRIBUTES	
BACKGROUND COLORS (Black text)	TEXT COLORS (Black background)
Black	Black
Blue	Blue
Green	Green
Cyan	Cyan
Red	Red
Magenta	Magenta
Brown	Brown
Gray	Gray
Black	Dark Gray
Blinking Blue	Light Blue
Blinking Green	Light Green
Blinking Cyan	Light Cyan
Blinking Red	Light Red
Blinking Magenta	Light Magenta
Blinking Brown	Yellow
Blinking Gray	White

Press ← for next test, <ESC> to quit, <SPACE> to toggle blink/intensify

**Figure 5-15. Enhanced Text Attributes Test (Blinking).**

**TEST E1: TEXT ATTRIBUTES**

<b>BACKGROUND COLORS</b>	<b>TEXT COLORS</b>
(Black text)	(Black background)
Black	Black
Blue	Blue
Green	Green
Cyan	Cyan
Red	Red
Magenta	Magenta
Brown	Brown
Gray	Gray
Dark Gray	Dark Gray
Light Blue	Light Blue
Light Green	Light Green
Light Cyan	Light Cyan
Light Red	Light Red
Light Magenta	Light Magenta
Yellow	Yellow
White	White

Press ← for next test, <Esc> to quit, <SPACE> to toggle blink/intensify

**Figure 5-16. Enhanced Text Attributes Test  
(Intensified)**

**E2, E3, E4 — Enhanced Color Character Set Tests**

These three screens display the available character set; E2 shows the characters in an 8 x 8 pixel matrix in 40-column mode; E3 shows them in an 8 x 14 pixel matrix in 80-column mode; and E4 shows them in 8 x 8 pixel matrix in 80-column mode with 43 lines.

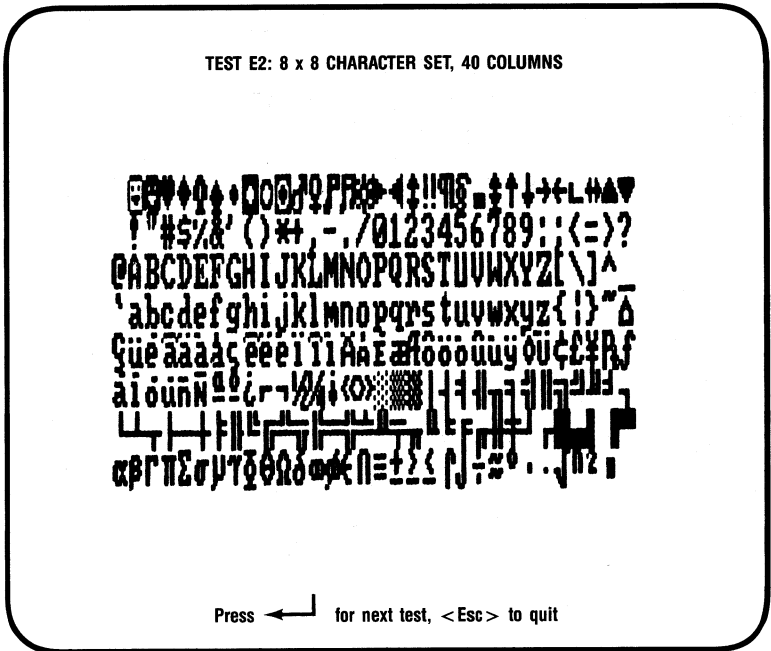

**Figure 5-17. Enhanced Character Set Test (8 x 8 pixel characters, 40 columns).**



TEST E4: 8 x 8 CHARACTER SET, 43 ROWS

Press ← for next test, <Esc> to quit

**Figure 5-19. Enhanced Character Set Test (8 x 8 pixel characters, 43 Rows).**



**E6 — 320 x 200 Resolution Graphics, 4 Colors**

This screen shows the four basic color components that provide the colors for this configuration: black, blue, green, and red. These colors are shown in 4 rectangular boxes. The colors should match their labels.

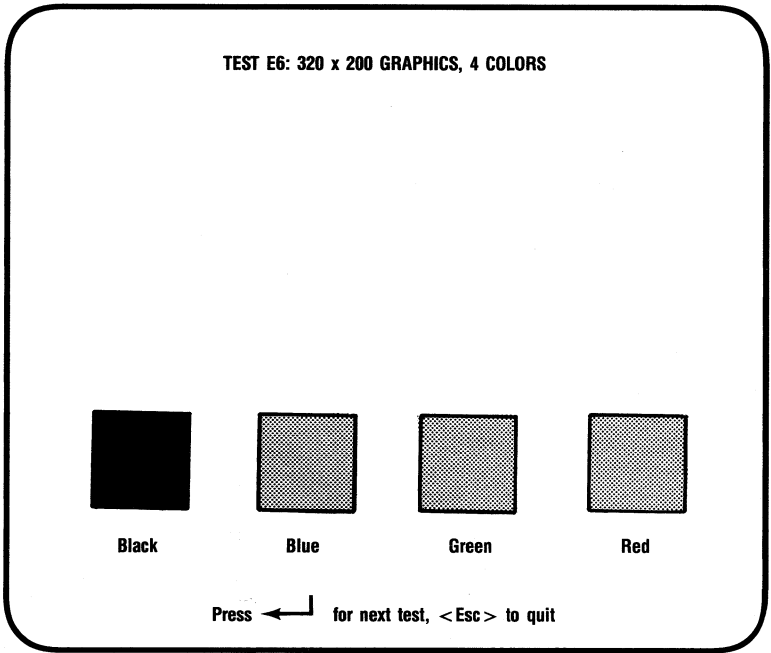
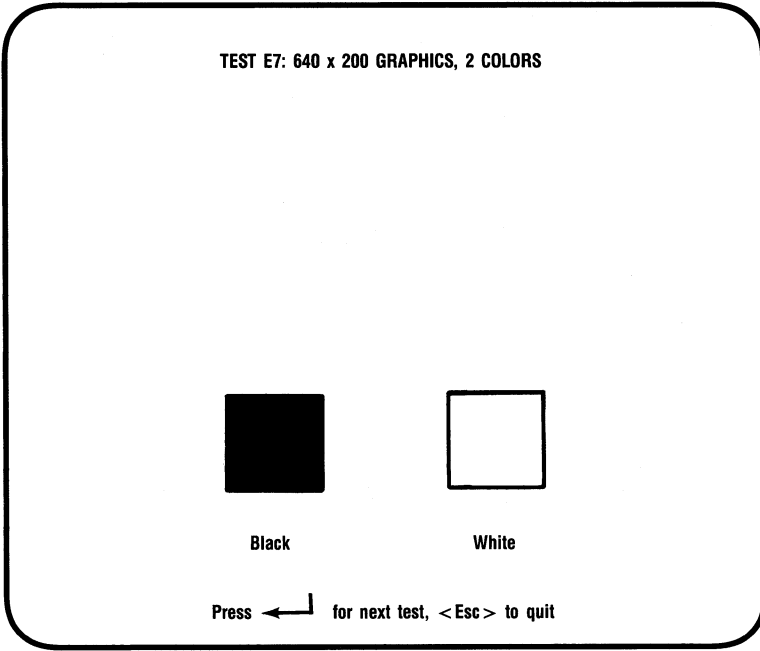

**Figure 5-21. Enhanced 320x200 4-Color Graphics Test.**



*E7 — 640 x 200 Resolution Graphics, 2 Colors*

This screen displays the colors black and white in rectangular boxes. The colors of the boxes should match their labels.



**Figure 5-22. Enhanced 640x200 2-Color Graphics Test.**

**E8 — 640 x 350 Resolution Graphics, Primary Colors**

This screen shows four intensities of four different colors — blue, green, red and gray, providing a total of 16 boxes. Except for the first column, each box should appear slightly different. If the last two red boxes are the same, even after your contrast and brightness controls are checked, then the Monitor Selection jumper may be set wrong.

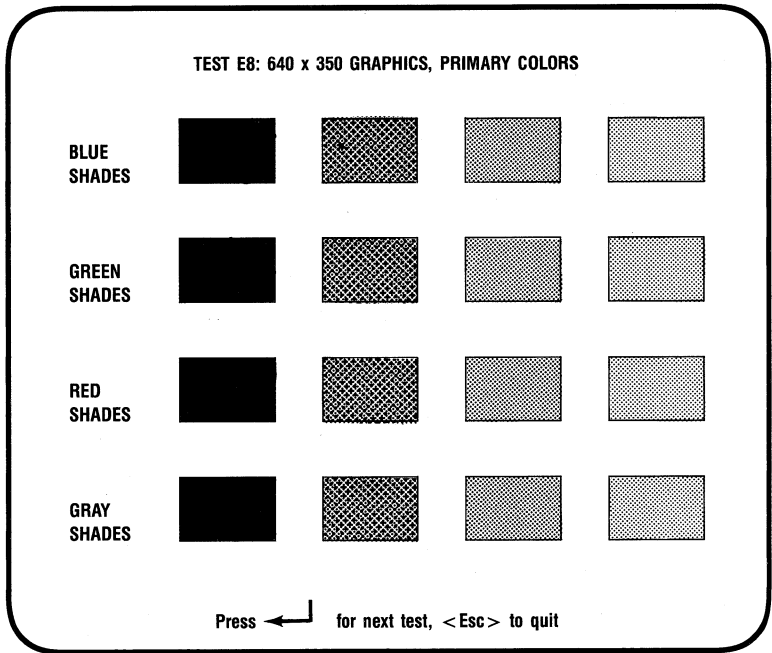

**Figure 5-23. Enhanced 640x350, Primary Colors Test.**

(This page intentionally left blank)

## SECTION 6

### PRODUCT REPAIR PROCEDURE

If your AST Research product ever requires repair, contact your dealer first. The dealer from whom you originally purchased the product can usually service the product. If you must return a hardware product to the factory for service, follow these guidelines to ensure rapid, accurate turnaround:

1. *Call AST Research Technical Support for a Return Authorization Number (RAN):* A technician will discuss the problem with you; if factory service is required, the technician will give you a Return Authorization Number (RAN). Always refer to the RAN when you return anything for service. AST Research will return anything without a RAN to the sender.
2. *If the product is covered under an AST Research Warranty:* There is no charge for parts or labor involved in the repair. Please include a copy of your original purchase receipt as the proof of date of purchase for all warranty repairs.
3. *If the product is not covered under a warranty:* Contact your dealer or AST Research Technical Support for instructions on obtaining service for your product.
4. *Parts not covered under the warranty:* Dealer- or user-installed parts (such as RAM chips) are not covered under the terms of the warranty. Dealer-installed parts are warranted by the dealer; parts that you install are covered only by the parts suppliers' warranties. If we find that your dealer- or user-installed parts are defective, we can identify which parts are defective, but we will not replace parts

unless you specifically authorize us to do so in writing when you send the board to us. The parts charges and any applicable labor charges will be billed COD.

5. *Describe the problem and return any related accessories:* Please include a brief but explicit written description of the problem when you return your AST product to the factory for repair. Also return any accessories that might relate to the problem. For example, if the the parallel port does not function correctly, be sure to return the parallel port adapter cable with the board.
  
6. *Be sure to provide a return shipping address that UPS can deliver to and include your RAN:* UPS cannot normally deliver to post office boxes. Reference the RAN issued to you by AST Technical Support on all correspondence. Securely package all materials to prevent shipping damage. Shipping charges must be prepaid; CODs will not be accepted. Ship the materials to the following address:

AST Research, Inc.  
Customer Service—RAN xxxx  
2722 Michelson  
Irvine, CA 92715

where xxxx is your assigned Return Authorization Number.

7. Once your product is repaired, we will return it to you by UPS or UPS Blue Label service, whichever is appropriate for your geographical location. We will return items covered by warranty at our expense. Shipping costs and repair expenses for items not covered by warranty will be billed COD. If you prefer overnight service (UPS Red Label), the shipping charges will be billed COD. If you want us to ship Federal Express, please give us your Federal Express account number for billing purposes.

# SECTION 7

## ENHANCEMENT OPTIONS

This section tells you how to install the following options:

- Section 7.1 tells you how to install the memory upgrade kit (part number 500305-006).
- Section 7.2 tells you how to install the parallel port upgrade kit (part number 500305-005).

The memory upgrade kit allows you to upgrade your AST-3G adapter memory from 64 to 256 Kilobytes (KB) by substituting eight 256-Kilobit (Kb) chips for the eight 64-Kb chips on your AST-3G board. The parallel port upgrade kit allows you to add a parallel port to your AST-3G by adding six chips and a parallel port ribbon cable and bracket to your AST-3G.

### 7.1 Installing the Memory Upgrade Kit

Following are instructions for replacing the eight 64-Kb chips on your AST-3G adapter with 256-Kb chips.

#### **STEP 1**

*Check that you have eight chips in your memory upgrade kit.*

You will need a flathead screwdriver or nut driver to remove the PC system cover and install the memory chips. (You can also use a chip puller to remove the existing memory chips.)

#### **STEP 2**

*Remove the PC or PC-AT cover:* Instructions for doing this are included in STEP 1 of Section 3.5.

**STEP 3**

*Remove ribbon cable if present:* This step only applies if you already have a parallel port installed on your AST-3G. Remove the parallel port ribbon cable connected to the AST-3G. Be sure to note its orientation for later reference when you reinstall it.

**STEP 4**

*Remove AST-3G from your PC:* Use a nut driver or a flathead screwdriver to remove the screw that secures the AST-3G bracket to the back of the PC chassis. Keeping the adapter level and using even pressure, remove the board from the PC system chassis.

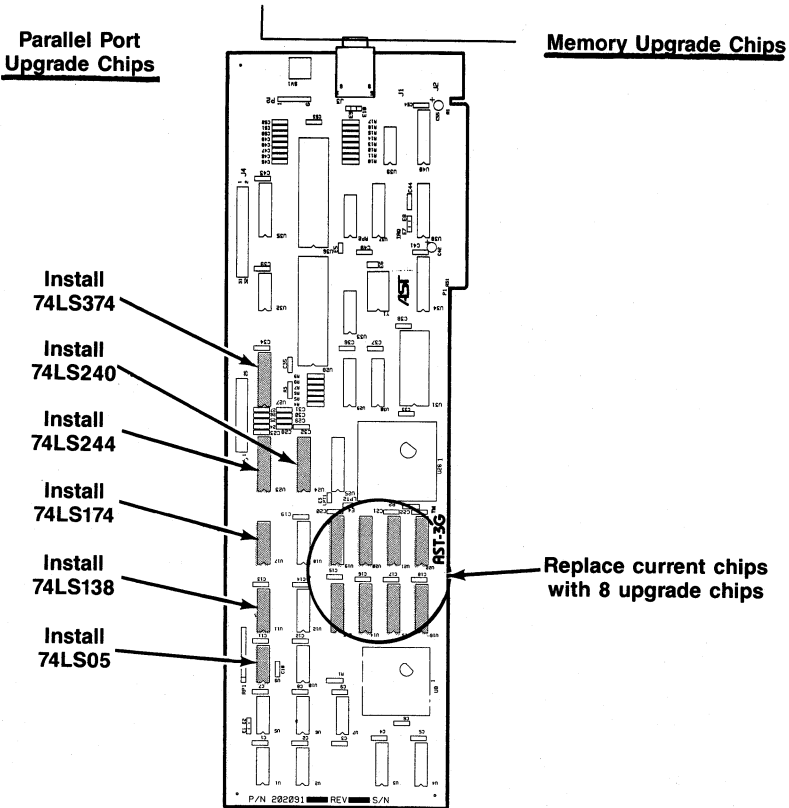

**Figure 7-1. AST-3G Adapter Upgrade Chip Placement.**

**STEP 5**

*Remove the eight 64-Kb chips from the AST-3G:* Remove the 64-Kb chips from the AST-3G by prying them loose with a screwdriver. Do not damage the chip pins so you can use them in the future. The position of the memory chips is shown in Figure 7-1.

**STEP 6**

*Install the eight 256-Kb chips:* Follow these guidelines for installing chips:

- Before handling any chips, discharge any static electricity on your body by touching a grounded surface such as the PC chassis.
- Chips *must* be properly oriented when you install them. The notch on each chip should be facing away from the AST-3G bracket. Also, any numbers printed on the chip should be facing right-side up when the board is held with the bracket on the right (the same as the other labeled components on the adapter).
- If a chip seems to be too wide to fit its socket, place it on its side on a flat surface and *gently* angle it under both thumbs to *slightly* bend the legs inward. This technique can also be useful for inserting a chip into a socket on the board. Angle the chip, and slightly insert one row of pins, then bring the other row down into position and slightly start its pins in the socket. Once you have both sides started, you can evenly press down on the chip to seat it firmly in its socket.

**STEP 7**

*Install AST-3G in your PC:* Unless you will also be installing the parallel port upgrade kit, follow the steps given in Section 3.5 for installing your AST-3G. See Section 7.2 for installing the parallel port upgrade kit.



## 7.2 Installing the Parallel Port Upgrade Kit

Follow this procedure to install the parallel port upgrade kit.

### STEP 1

*Check that your parallel port upgrade kit includes:*

- Six chips.
- Parallel port ribbon cable.
- Ribbon cable bracket.

### STEP 2

*Remove the PC cover:* Follow the instructions given in STEP 1 of Section 3.5.

### STEP 3

*Remove AST-3G from your PC:* Use a nut driver or a flathead screwdriver to remove the screw that secures the AST-3G bracket to the back of the PC chassis. Keeping the adapter level and using even pressure, remove the adapter from the PC system chassis.

### STEP 4

*Install the parallel port chips:* Check that you have six chips marked with the following numbers:

74LS05	74LS244
74LS138	74LS240
74LS174	74LS374

Install the chips in the locations shown in Figure 7-1. Follow STEP 5 shown in Section 7.1 for detailed information on how to install ICs.

Follow STEPS 3 through 11 in Section 3.5 to install the parallel port ribbon cable on the AST-3G, and to install the AST-3G in your PC system.

# APPENDIX A

## FEATURE CONNECTOR

AST-3G Model 1 provides a 32-pin feature connector which is compatible with the IBM EGA feature connector. The feature connector is located along the top of the Model 1 and can be used to support feature adapters that enhance the AST-3G Model 1.

Following are descriptions of the signals that are “inputs” from the AST-3G Model 1 to the feature connector, or “outputs” through the feature connector to the Model 1.

**Table A-1. Feature Connector Inputs and Outputs.**

Pin #	Signal	Description
4	J1	Pin J1 connects to auxiliary jack 1 on AST-3G's back panel.
5	J2	Pin J2 connects to auxiliary jack 2 on the back panel of AST-3G.
6	G'OUT	Secondary green output.
7	R'OUT	Secondary red output.
8	B'OUT	Secondary blue output.
9	ATRS/L	Attribute shift/load. This signal determines serialization of video information. The shift register parallel loads at the dot clock leading edge when this signal is low.
10	BOUT	Blue output.
11	GOUT	Primary green output.
12	G	Green input.
13	R'	Secondary red input.

**Table A-1. Feature Connector Inputs and Outputs  
(Continued).**

<b>Pin #</b>	<b>Signal</b>	<b>Description</b>
14	B	Blue input.
15	R	Primary red input.
16	R OUT	Red Output.
17	FEAT 1	Output to bit 6 of Input Status register 0 (Feature Code 1).
18	BLANK	Composite horizontal and vertical blanking signal from the CRTC.
19	FEAT 0	Output to bit 5 of the Input Status register 0 (Feature Code 0).
20	FC1	Input from bit 1 of the Feature Control register.
21	FC0	Input from bit 0 of the Feature Control register.
22	G'I	Secondary green/Intensity input.
23	B'V	Secondary blue input/Monochrome video.
24	HIN	Horizontal retrace input from the CRTC.
25	VIN	Vertical retrace input.
26	14MHz	14 MHz signal from the system board.
27	Internal	Output to bit 4 of the Miscellaneous Output register (Disable Internal Video Drivers).
28	EXT OSC	External dot clock output.
29	V OUT	Vertical retrace output.
30	HOUT	Horizontal retrace output.

Figure A-1 shows the layout and pin numbering of the feature connector.

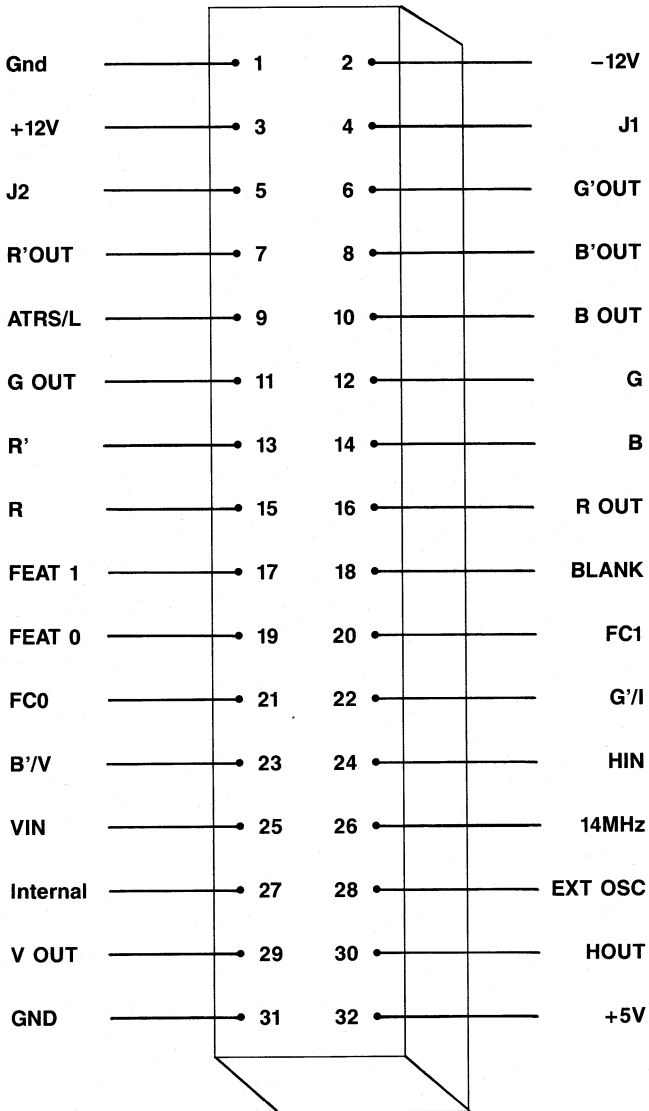

Figure A-1. Feature Connector Layout.

(This page intentionally left blank.)

## APPENDIX B

### LIGHT PEN INTERFACE

Your AST-3G Model 1 adapter provides a five-pin connector, labeled P2, for a standard light pen. The pinouts for the light pen are shown in Table B-1.

*Table B-1. Light Pen Interface Pinouts.*

Light Pen Connector Pin Number	Pin Function
1	+Light Pen Input
2	Not used
3	+Light Pen Switch
4	Ground
5	+5 Volts
6	12 Volts

The P2 light pen connector is shown in Figure B-1. Placement of the P2 connector on the AST-3G Adapter is shown in Figure 3-2.

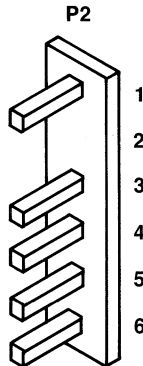

*Figure B-1. Light Pen Interface Connector.*

(This page intentionally left blank)

# **FCC WARNING**

This equipment has been certified to comply with the limits for a Class B computing device, pursuant to Subpart J of Part 15 of FCC Rules. Only peripherals (computer input/output devices, terminals, printers, etc.) certified to comply with the Class B limits may be attached to a computer that complies with Class B limits. Operation with non-certified peripherals is likely to result in interference to radio and TV reception. When connecting to a peripheral device, a shielded I/O cable is required to ensure compliance with FCC rules.

## **Instructions to User**

This equipment generates and uses radio frequency energy and if not installed and used properly, that is, in strict accordance with the manufacturer's instructions, may cause interference to radio and television reception. It has been type tested and found to comply with the limits for a Class B computing device in accordance with the specifications in Subpart J of Part 15 of FCC Rules, which are designed to provide reasonable protection against such interference in a residential installation. However, there is no guarantee that interference will not occur in a particular installation. If this equipment does cause interference to radio or television reception, which can be determined by turning the equipment off and on, the user is encouraged to try to correct the interference by one or more of the following measures:

- Reorient the receiving antenna.
- Relocate the computer with respect to the receiver.
- Move the computer away from the receiver.
- Plug the computer into a different outlet so that computer and receiver are on different branch circuits.
- Ensure that board slot covers are in place when no board is installed.
- Ensure that all brackets are fastened securely to the PC chassis.



## **FCC Warning**

If necessary, the user should consult the dealer or an experienced radio/television technician for additional suggestions. The user may find the following booklet prepared by the Federal Communications Commission (FCC) helpful: "How to Identify and Resolve Radio-TV Interference Problems." This booklet is available from the U.S. Government Printing Office, Washington, DC 20402. Stock No. 004-000-00345-4.

**AST RESEARCH, INC.**

**Product Comment Form**

**AST-3G™ Model 1  
User's Manual  
000337-001A**

We appreciate your comments regarding any problems or suggestions related to AST Research products. Please use this form to communicate any observations that you have concerning the improvement of either the product itself or the product documentation provided in this manual.

**Submitter Information**

Submitter's name:

Address:

**Product/Manual Comments and Suggestions**

Please mail this form to:

**AST Research, Inc.  
Attn: Product Marketing  
2121 Alton Ave.  
Irvine, CA 92714**



## LIMITED WARRANTY

AST Research, Inc. warrants to the original purchaser of this AST Research, Inc. product that it is to be in good working order for a period of 2 years from the date of purchase from AST Research, Inc. or an authorized AST Research, Inc. dealer. Should this product, in AST Research, Inc.'s opinion, malfunction during the warranty period, AST will, at its option, repair or replace it at no charge, provided that the product has not been subjected to misuse, abuse, or non-AST authorized alterations, modifications, and/or repairs.

Products requiring Limited Warranty service during the warranty period should be delivered to AST with proof of purchase. If the delivery is by mail, you agree to insure the product or assume risk of loss or damage in transit. You also agree to prepay shipping charges to AST.

ALL EXPRESS AND IMPLIED WARRANTIES FOR THIS PRODUCT INCLUDING, BUT NOT LIMITED TO, THE WARRANTIES OF MERCHANTABILITY AND FITNESS FOR A PARTICULAR PURPOSE ARE LIMITED IN DURATION TO THE ABOVE 2 YEAR PERIOD. Some states do not allow limitations on how long an implied warranty lasts, so the above limitations may not apply to you.

UNDER NO CIRCUMSTANCES WILL AST RESEARCH, INC. BE LIABLE IN ANY WAY TO THE USER FOR DAMAGES, INCLUDING ANY LOST PROFITS, LOST SAVINGS OR OTHER INCIDENTAL OR CONSEQUENTIAL DAMAGES ARISING OUT OF THE USE OF, OR INABILITY TO USE, SUCH PRODUCT. Some states do not allow the exclusion or limitation of incidental or consequential damages for consumer products, so the above limitations or exclusion may not apply to you. THIS WARRANTY GIVES YOU SPECIFIC LEGAL RIGHTS, AND YOU MAY ALSO HAVE OTHER RIGHTS WHICH MAY VARY FROM STATE TO STATE.

The limited warranty applies to hardware products only.



800337-001 A