

Aptiva Reference Guide

First Edition (December, 1998)

The following paragraph does not apply to any state or country where such provisions are inconsistent with local law: INTERNATIONAL BUSINESS MACHINES CORPORATION PROVIDES THIS PUBLICATION "AS IS" WITHOUT WARRANTY OF ANY KIND, EITHER EXPRESS OR IMPLIED, INCLUDING, BUT NOT LIMITED TO, THE IMPLIED WARRANTIES OF MERCHANTABILITY OR FITNESS FOR A PARTICULAR PURPOSE. References to IBM products, programs, or services do not imply that IBM intends to make them available outside the United States.

This publication includes information that supports multiple models; therefore not all text may apply to your model. This publication could contain technical inaccuracies or typographical errors. Changes are periodically made to the information herein; these changes will be made in later editions. IBM may make improvements and/or changes in the product(s) and/or program(s) at any time.

Address comments about this publication to IBM HelpCenter – Aptiva PC, IBM Corporation, 3039 Cornwallis Rd., Dept. BM1/203, Research Triangle Park, NC 27709-2195 USA. Information you supply may be used by IBM without obligation.

For copies of publications related to this product, call 1-919-517-2800 in the Continental U.S.A. In Canada, call toll free 1-800-465-7999.

© **Copyright International Business Machines Corporation 1998. All rights reserved.**

Note to U.S. Government Users – Documentation related to restricted rights – Use, duplication or disclosure is subject to restrictions set forth in GSA ADP Schedule Contract with IBM Corp.

Table of Contents

iii	Table of Contents
1	Notices
3	Trademarks
4	Conventions used in this book
6	Safety information
10	Regulatory notices
15	Ergonomics
17	Arranging a comfortable and productive work area
21	Aptiva Online Help and Software
23	Aptiva How Do I...cue cards
24	Aptiva online help
25	Readme files
26	Instructions for installing and replacing hardware
26	Handling discs
27	Installing programs
29	Troubleshooting
31	Diagnosing and recovering from problems
32	Quick step guide
33	Some simple questions to ask first...
38	Solving hardware problems
48	Solving software problems
51	Solving monitor problems
54	Solving audio, multimedia, and modem problems
58	Solving DVD problems
59	Responding to error codes
69	Recovering factory installed programs and files

71	Setup Utility
73	Using the Setup Utility
81	HelpWare support and services
83	What do I do first?
86	How do I get help electronically?
87	How and when do I contact the IBM PC HelpCenter?
91	How and when do I purchase additional support?
97	Adding and removing hardware
99	Preparing to work with the computer
100	Adding and removing drives
105	Identifying system board components
111	Index

Notices

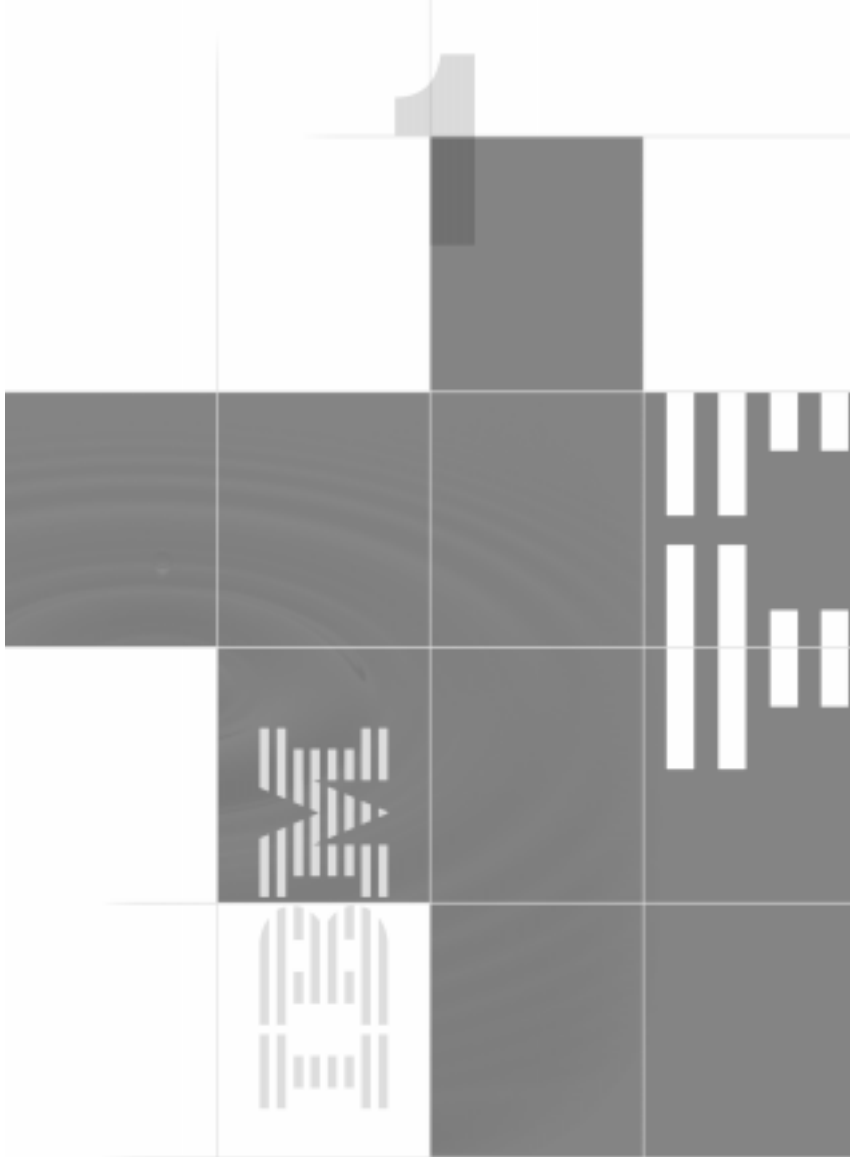



Notices

References in this publication to IBM products, programs, or services do not imply that IBM intends to make these available in all countries in which IBM operates. Any reference to an IBM product, program, or service is not intended to state or imply that only IBM's product, program, or service may be used. Any functionally equivalent product, program, or service that does not infringe any of IBM's intellectual property rights may be used instead of the IBM product, program, or service. Evaluation and verification of operation in conjunction with other products, except those expressly designated by IBM, are the user's responsibility.

IBM may have patents or pending patent applications covering subject matter in this document. The furnishing of this document does not give you any license to these patents. You can send license inquiries, in writing, to the IBM Director of Licensing, IBM Corporation, 500 Columbus Avenue, Thornwood, NY 10594.

Trademarks

The following terms are trademarks or registered trademarks of the IBM Corporation in the United States or other countries or both:

- Aptiva
- Rapid Access
- ScrollPoint
- HelpCenter
- HelpWare
- IBM





Other company, product, and service names may be trademarks or service marks of others.

Microsoft and the Windows logo are trademarks or registered trademarks of Microsoft Corporation.

Conventions used in this book

Symbols

The following list contains an explanation of the symbols used in this document.

Symbol	Explanation
 Note	This symbol is used when there is information you might find especially useful. The information may also warn you about possible problems you could encounter.
 Attention	This symbol is used when there is important information that can help you avoid damage to the hardware or software that came with your computer.
 Caution!	This symbol is used when there is important information that can help you avoid potential injury.
 Danger!	This symbol is used when there is important information which can help you avoid the risk of serious personal injury or death.

Notices

Highlighting

There are several ways that text is highlighted in this book. Each highlighting convention has a specific purpose.

Highlight	Purpose
Bold	Bold font is used to identify items on the screen you are instructed to click or double-click. Bold font is also used in headings, table titles, and numbered lists.
Example	Example font is used to show text that you need to type from your keyboard.
<i>Italic</i>	Italic font is used to show proper names of programs or books. Italic font is also used in table footnotes and sidenotes.
" Quotes "	Quotation marks are used to identify window, screen, and heading names.
<u>Underline</u>	Underline font is used to call special emphasis to a particular word or instruction.

Safety information

Installation

The construction of the IBM Aptiva Personal Computer provides extra protection against the risk of electrical shock. The IBM Aptiva PC has a power cord with a three-prong plug that is required to ground metal parts. It is the responsibility of the person installing the computer to connect it to a properly grounded electrical outlet. Seek professional assistance before using an adapter or extension cord; these devices could interrupt the grounding circuit.

If the computer is connected to an electrical outlet that is incorrectly connected to the building wiring, serious electrical shock could result.

Continued protection against electrical shock . For continued protection against the risk of electrical shock, follow these steps:

- Connect your computer only to an electrical outlet of the correct voltage. If you are unsure about the voltage of the electrical outlet you are using, contact your local power company.
- If your computer has cables other than the power cords, you must connect them before plugging the power cords into an electrical outlet. Before removing these cables, you must first unplug the power cords from the outlet.
- If your computer has a telephone connection, do not touch the telephone cords when there is lightning in the area.
- Do not use or store the computer in an area where it can become wet.



Caution!

Your computer uses lithium batteries. There may be a risk of fire, explosion, or burns if the batteries are handled incorrectly. To ensure safety:

Do not recharge, disassemble, heat, or incinerate a lithium battery.

Replace the battery with an identical or equivalent type lithium battery.

Discard used lithium batteries according to local country dispositions.

Notices



Danger!

To avoid shock hazard:

Do not connect or disconnect any cables or perform installation, maintenance, or reconfiguration of this product during an electrical storm.

The power cord must be connected to a properly wired and grounded receptacle.

Any equipment to which this product will be attached must also be connected to properly wired electrical outlets.

Electrical current from power, telephone, and communications cables is hazardous. To avoid shock hazard, use the steps described in this section to connect and disconnect cables when installing, moving, or opening the cover of this product.

- Make sure all replacement parts have characteristics identical or equivalent to the original parts. Other parts may not have the same safety features.
- Personal injury or electrical shock may result if you undertake actions other than those specifically described in this book. This is particularly true if you try to service or repair the power supply, monitor, or built-in modem. Always refer service or repairs to qualified service personnel.

Safety while working with hardware

Each time you open your computer, you must follow specific safety procedures to ensure that you do not damage your computer. For your safety, and the safety of your equipment, follow the steps for "Disconnecting your computer" on page 8 before you remove the cover of the system unit (if included with the model you purchased).

Connecting your computer.

To connect your computer:

- 1** Turn off the computer and any component you are going to attach to it that may have its own power switch.
- 2** Attach cords (such as a monitor cord) to the computer.
- 3** Attach signal cables (such as a telephone cord) to properly grounded outlets.
- 4** Attach power cables to properly grounded electrical outlets.
- 5** Turn on the computer and any attached components that may have their own power switch.

Disconnecting your computer.

To disconnect your computer:

- 1 Turn off the computer and any attached component that may have its own power switch.
- 2 Unplug all power cables from electrical outlets.
- 3 Remove all signal cables (such as a telephone cord) from their receptacles.
- 4 Disconnect all cables attached to the computer; this includes power cords, input/output cables, and any other cables attached to the computer.

Regulatory safety notice for the CD-ROM and DVD-ROM drive

This notice contains required safety information about the CD-ROM/DVD-ROM drive in your computer (if included with the model you purchased). The CD-ROM/DVD-ROM drive is a Class 1 laser product, and Class 1 laser products are not considered to be hazardous. The design of the laser system and CD-ROM/DVD-ROM drive ensures that during normal operation, there is no exposure to laser radiation above Class 1 level.

Please note that the CD-ROM/DVD-ROM drive does not contain any user adjustable or serviceable parts. Service on this drive should only be performed by a trained service provider.

Laser compliance statement. Some IBM Personal Computer models are equipped from the factory with a CD-ROM or DVD-ROM drive. CD-ROM/DVD-ROM drives are also sold separately as options. The CD-ROM/DVD-ROM drive is a laser product. The CD-ROM/DVD-ROM drive is certified in the U.S. to conform to the requirements of the Department of Health and Human Services 21 Code of Federal Regulations (DHHS 21 CFR) Subchapter J for Class 1 laser products.

Notices

Elsewhere, the drive is certified to conform to the requirements of the International Electrotechnical Commission (IEC) 825 and CENELEC EN 60 825 for Class 1 laser products.

When a CD-ROM/DVD-ROM drive is installed, note the following:



Caution!

Caution! Use of controls or adjustments or performance of procedures other than those specified herein might result in hazardous radiation exposure.

Removing the covers of the CD-ROM/DVD-ROM drive could result in exposure to hazardous laser radiation. There are no serviceable parts inside the CD-ROM/DVD-ROM drive. Do not remove the CD-ROM/DVD-ROM drive covers.

Some CD-ROM/DVD-ROM drives contain an embedded Class 3A or Class 3B laser diode. Note the following:



Danger!

Danger!

Laser radiation when open. Do not stare into the beam, do not view directly with optical instruments, and avoid direct exposure to the beam.

Regulatory notices

FCC and telephone company requirements

If your IBM Aptiva PC has a built-in modem, the following Federal Communications Commission (FCC) and telephone company requirements apply:

- 1 The modem adapter card is located in the back of the system unit. It complies with Part 68 of the FCC rules. A label is affixed to the built-in modem that contains, among other things, the FCC registration number, USOC, and Ringer Equivalency Number (REN) for this equipment. If these numbers are requested refer to "Opening the system unit" on page 100 for instructions on how to open the system unit to see the label and provide this information to your telephone company.
- 2 The REN is useful to determine the quantity of devices you may connect to your telephone line and still have those devices ring when your number is called. In most, but not all areas, the sum of the REN of all devices should not exceed five (5.0). To be certain of the number of devices you may connect to your line, as determined by the REN, you should call your local telephone company to determine the maximum REN for your calling area.
- 3 If the built-in modem causes harm to the telephone network, the telephone company may discontinue your service temporarily. If possible, they may notify you in advance; if advance notice isn't practical, you may be notified as soon as possible. You may be advised of your right to file a complaint with the FCC.
- 4 Your telephone company may make changes in its facilities, equipment, operations, or procedures that could affect the proper operation of your equipment.

Notices

If they do, you may be given advance notice so as to give you an opportunity to maintain uninterrupted service.

- 5 If you experience trouble with this built-in modem, contact your Authorized Seller, or the IBM HelpCenter – Aptiva PC, IBM Corporation, 3039 Cornwallis Rd., Bldg. 203, Research Triangle Park, NC 27709-2195 1-919-517-2800, for repair/warranty information. The telephone company may ask you to disconnect this equipment from the network until the problem has been corrected, or until you are sure the equipment is not malfunctioning.
- 6 No customer repairs are possible to the modem.
- 7 The modem may not be used on coin service provided by the telephone company. Connection to party lines is subject to state tariffs. Contact your state public utility commission or corporation commission for information.
- 8 When ordering network interface (NI) service from the Local Exchange Carrier, specify service arrangement USOC RJ11C.

Federal Communications Commission (FCC) statement

IBM Aptiva PC 2163 or 2158 . The following statement applies to this IBM product. The statement for other IBM products intended for use with this product will appear in their accompanying manuals.

This equipment has been tested and found to comply with the limits for a Class B digital device, pursuant to Part 15 of the FCC Rules. These limits are designed to provide reasonable protection against harmful interference in a residential installation. This equipment generates, uses, and can radiate radio frequency energy and, if not installed and used in accordance with the

instructions, may cause harmful interference to radio communications. However, there is no guarantee that interference will not occur in a particular installation. If this equipment does cause harmful interference to radio or television reception, which can be determined by turning the equipment off and on, the user is encouraged to try to correct the interference by one or more of the following measures:

- Reorient or relocate the receiving antenna.
- Increase the separation between the equipment and receiver.
- Connect the equipment into an outlet on a circuit different from that to which the receiver is connected.
- Consult an IBM authorized dealer or service representative for help.

Properly shielded and grounded cables and connectors must be used in order to meet FCC emission limits. Proper cables and connectors are available from IBM authorized dealers. IBM is not responsible for any radio or television interference caused by using other than recommended cables and connectors or by unauthorized changes or modifications to this equipment. Unauthorized changes or modifications could void the user's authority to operate the equipment.

This device complies with Part 15 of the FCC Rules. Operation is subject to the following two conditions: (1) this device may not cause harmful interference, and (2) this device must accept any interference received, including interference that may cause undesired operation.

Responsible Party:

Notices

International Business Machines Corporation
New Orchard Road
Armonk, NY 10504
Telephone: 1-919-543-2193

This Class B digital apparatus meets all requirements of the Canadian Interference-Causing Equipment Regulations.

Cet appareil numérique de la classe B respecte toutes les exigences du Règlement sur le matériel brouilleur du Canada.

European Community Directive Conformance statement

This product is in conformity with the protection requirements of EU Council Directive 89/336/EEC on the approximation of the laws of the Member States relating to electromagnetic compatibility.

IBM cannot accept responsibility for any failure to satisfy the protection requirements resulting from a non-recommended modification of the product, including the fitting of non-IBM option cards.



Ergonomics





Ergonomics

Arranging a comfortable and productive work area



Note

The computer you purchased may have components which are different from those shown here.

Arranging your work area

When you arrange your computer, position your monitor and keyboard directly in front of you. Place the mouse close to the keyboard so that you can use it without stretching or leaning over to one side.

The system unit is usually kept on the floor under or beside your desk. Be sure to place it in an area that will not block the space you need to put your legs under the work surface.

Organize your desk to reflect the way you use work materials and equipment. Place the things that you use most regularly, such as a mouse or telephone, within the easiest reach.

Choosing a chair

- Use a chair that gives you good back support.
- When you sit, make sure your thighs are parallel to the floor and your feet are resting flat on the floor or on a footrest. Your knees should form a 90 degree angle.

Positioning the monitor

- Place the monitor at a comfortable viewing distance, usually 20 to 24 inches away. You can also use the length of your arm to determine a comfortable viewing distance.
- Adjust your monitor so the top of the screen is at, or slightly below, eye level.
- Keep the screen clean. For cleaning instructions, refer to the documentation that came with your monitor.
- If you place the monitor near a window, consider using curtains or blinds to minimize glare from sunlight. Also be sure to keep the monitor perpendicular to the windows to reduce glare when the curtains or blinds are open. Try to avoid placing the monitor directly in front of a window.
- Use dim room lighting. If you need more light on your work, you should position the light so it shines on your work surface but not onto the monitor screen.
- Use the monitor controls to adjust the screen's brightness and contrast levels to a comfortable level. You may have to do this more than once a day if the light in the room changes. For monitor control adjustment instructions, refer to the documentation that came with your monitor.
- When your eyes focus on a specific object for a long period of time, they may become tired. If you spend a lot of time looking at your screen, remember to take

Ergonomics

frequent breaks. Look up periodically and focus on an object that is further away. This will give the muscles in your eyes a chance to relax.

Positioning the keyboard

- Make sure the keyboard height is comfortable for typing.
- When you type, keep your forearms parallel to the floor and relax your shoulders and upper arms. Your elbows should form a 90 degree angle.
- Type with a light touch, keeping your hands and fingers relaxed. Your wrists should also be straight.
- If your computer came with a wristrest and you choose to use it, do not rest your hands on the wristrest or desktop while you are typing. Instead, use the wristrest only when resting. If you prefer not to use the wristrest, you may remove it and use the keyboard without it.

Positioning the mouse

- Position your mouse on the same surface as your keyboard so that they are at the same level. Allow enough space so that you can use your mouse without stretching or leaning over.
- When you use the mouse, hold it lightly with all your fingers and click gently. Move the mouse with your entire arm instead of only using your wrist.

For more detailed information and tips about how to use your computer, refer to the tutorials on your computer or visit the IBM Healthy Computing Web site at <http://www.pc.ibm.com/us/healthycomputing>



Aptiva Online Help and Software





Aptiva Online Help and Software

Your computer came with several types of information and software. This chapter includes information about:

- Aptiva How Do I...cue cards
- Aptiva online help
- Readme files
- Finding instructions for installing and replacing hardware
- Software installed on CD or DVD

Aptiva How Do I...cue cards

Your computer came with cue cards that automatically start a program and provide the steps to complete a selected task. You can find How Do I...through *Access Aptiva* on your Aptiva customized desktop.

To start How Do I...:

- 1 Start **Access Aptiva** (if it's not already started).
- 2 Click **How do I...**

How Do I...includes the following cue cards:

- Register My Computer
- What's in My Aptiva
- Set up a Printer
- Use Standby to Save Energy
- Play a Music CD
- Send and Receive Faxes
- Connect to the Internet
- Browse the Web
- Visit the Aptiva Web Page

- Search the Internet
- Send and Receive E-Mail
- Write a Letter

Aptiva online help

Your computer came with instructions that are located on the hard disk drive. You can find this information through the *Access Aptiva* area on your Aptiva customized desktop.

When upgrading hardware or working with the Setup Utility, you should read and print the instructions you want to use. All other topics can be used online.

To start Aptiva online help:

- 1 Start **Access Aptiva** (if it's not already started).
- 2 Click **Get Help**.
- 3 Click **Aptiva Help Files**.

Aptiva online help contains information and instructions for many tasks including:

- Arranging the workplace
- Registering the Aptiva PC
- Adjusting sound and display settings
- Setting up a modem
- Using the computer
- Connecting to the Internet
- Sending e-mail
- Maintaining the computer
- Updating software

Aptiva Online Help and Software

- Recovering from problems
- Upgrading hardware

If you need more information about your computer, Aptiva online help also includes information about:

- Aptiva Help
- Year 2000
- Access Aptiva
- The Internet
- DVD
- Computer care
- Computer configuration
- Hardware components
- Upgrade preparation
- Software programs
- Support

Readme files

Another type of online information is available in README.TXT files. These files usually come with programs and contain information about additional features. README.TXT files also may contain instructions about setting up the program to run most efficiently.

Instructions for installing and replacing hardware

If you decide to upgrade or replace hardware components in your Aptiva PC, you will need to print the instructions for the hardware you want to work with.

Your computer came with information that is located on the hard disk drive. For information about using these instructions, see "Aptiva online help" on page 24.

Handling discs



Attention

If your drive tray has clips, make sure they are retracted before you insert a disc.

The computer you purchased came with either a Compact Disc (CD) or Digital Versatile Disc (DVD) drive. To insert a CD or DVD into the drive:

- 1 Open the loading tray by pressing the **Eject** button on the drive.
- 2 Remove the disc from the sleeve or case.
- 3 Place the disc into the circular recess of the tray. Make sure that the label on the disc is facing up. Some DVDs are dual-sided with a label on both sides of the DVD.

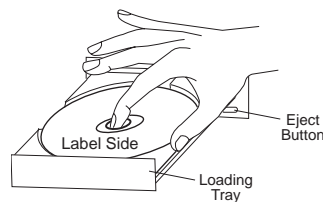

Note

In some cases, the hard disk drive in the model you purchased may not be large enough to complete a full install of each program. In these cases, use the "partial install" option if you want to install all of the programs to the same hard disk drive.

- 4 Close the loading tray by pressing the **Eject** button. You can also push gently on the front of the tray until it begins to retract.

Aptiva Online Help and Software

Installing programs

When you set up your computer, software programs that may have come on CD-ROMs and DVD-ROMs are packed with the Aptiva publications. Other programs have been installed on the hard disk drive. To locate these programs, look in the **Programs** menu in the Windows **Start** menu.

Some entertainment programs that may have come with your computer may contain language not suitable for children. The Entertainment Software Review Board (ESRB), has reviewed many software programs and maintains a list of program titles and ratings. To find a rating for a program, contact the ESRB Web site at <http://www.esrb.org>.

PROGRAMS MAY VARY FROM RETAIL VERSIONS AND MAY NOT INCLUDE ALL DOCUMENTATION OR FUNCTIONS.

AutoPlay

Most discs are "AutoPlay enabled". If the AutoPlay feature of Windows is enabled, it will automatically start the installation program (or the first song of a music CD) when you insert a disc in the drive. For more information about AutoPlay, refer to the Microsoft Windows help system.

Some programs have files that are installed on your hard disk drive and also require a CD or DVD. If the program is already installed and you insert the disc, the AutoPlay feature will start the program automatically.

If AutoPlay is disabled, you can install programs with the *Aptiva Installer*.



Note

If AutoPlay is enabled, you may need to start Aptiva Installer before inserting the CD. If the program you are installing was previously uninstalled using Aptiva Installer, the program should be listed on the Show Uninstalled Programs tab.

Aptiva Installer

To install a program with *Aptiva Installer*:

- 1** Insert the CD for the program you want to install.
- 2** Start *Aptiva Installer* by clicking the Windows **Start** button, then selecting **Aptiva Installer**.
- 3** Click the **Install New Program** tab.
- 4** Click the **Find Install Program** button.
- 5** *Aptiva Installer* recognizes and displays the title of the programs that came with your computer. Click **Install**.
- 6** The installed programs are added to the **Show Installed Programs** tab. Click the **OK** button.

You can also use *Aptiva Installer* to remove programs you installed with *Aptiva Installer*.

You can use the IBM Update Connector to look for available updates for the software that came from the factory with your computer. For information about IBM Update Connector, see Aptiva Help. For information about Aptiva Help, see "Aptiva online help" on page 24.

Troubleshooting





Troubleshooting

Diagnosing and recovering from problems

This chapter contains information that can help you solve common problems that you might have with your computer.

You should look through this chapter to find the problem description or error code that matches the problem you are having. When you find the description, simply follow the steps to solve the problem. Some problems have multiple steps. You should follow the steps until the problem is solved. A problem description may contain steps which you may not be required to follow.

The information contained in this chapter is intended for several models of the Aptiva Personal Computer. The computer you purchased may not have some of the hardware discussed in these sections.

If your computer did not come with the hardware described, some of the troubleshooting information may not apply. For example, if the model you purchased did not contain a Rapid Access keyboard, instructions about the Rapid Access keyboard will not apply. Follow the steps for the hardware that came with your computer.

If you follow the steps in this chapter and the problem continues, you can still get help. See "HelpWare support and services" on page 81 for more information about contacting IBM.

To run the diagnostics programs, insert the "Product Recovery and Diagnostics CD-ROM" in the CD drive and type PCDR.

Quick step guide

If you think you have a problem with your computer, you can use the following quick step guide to determine the nature of the problem.

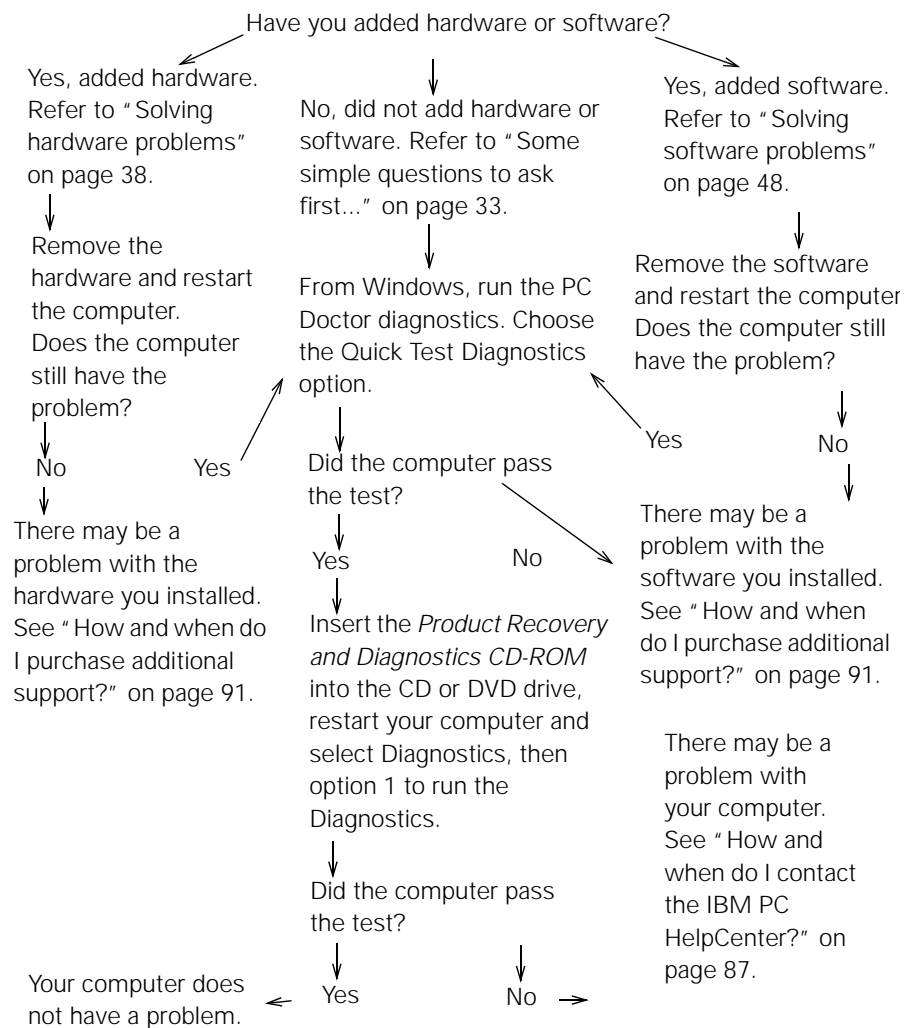

Troubleshooting

Some simple questions to ask first...

Are both the computer and monitor power lights lit?

- | | |
|------------|---|
| Yes | Power is reaching the system and monitor. See "Did the system beep after it was turned on?" on page 34. |
| No | <ol style="list-style-type: none"> 1 Press the On/Off buttons on the computer and monitor to make sure they are turned on. 2 Make sure the power switch that is attached to the power supply at the back of the system unit is pressed in the on position ("1" is on, "0" is off). This power switch may not be available for all computers. 3 Make sure the system unit and monitor cables are correctly and securely connected. Make sure the system unit and monitor power cords are plugged into electrical outlets. The <i>Setup Poster</i> shows how the cables and cords should be connected. 4 Make sure the electrical outlets you are using are not controlled by a wall or dimmer switch.
If you are using a multiple outlet device (for example, a power surge protector or power strip), make sure it is plugged in and turned on. |



If any of these problems continue after taking the actions listed, run the diagnostics programs that came with your computer. If you need service, see "HelpWare support and services" on page 81.

Did the system beep after it was turned on?

Yes

There may be a hardware problem.

- If you added hardware, remove it and restart the computer to see if the problem is corrected. If the problem is corrected, you may not have installed your hardware correctly. Reinstall your hardware. For instructions on installing hardware in the system unit, see the Aptiva online help. If the problem is not corrected, see "Solving hardware problems" on page 38.
- Make sure that the system memory modules are properly installed. If the memory is not installed correctly, the system will beep several times (in a 2 long beeps - 3 short beeps sequence). Reinstall the memory modules. If you hear a beep sequence other than the 2 long-3 short beeps, or if the memory modules are installed correctly, see "HelpWare support and services" on page 81 for information on obtaining service. If you have not added hardware, see "HelpWare support and services" on page 81 for information on obtaining service.

Yes, more than once

There is a problem with the system unit. Find the error code or message in the section "Responding to error codes" on page 59.

No

The system has passed the Power-On Self Test (POST).



If any of these problems continue after taking the actions listed, run the diagnostics programs that came with your computer. If you need service, see "HelpWare support and services" on page 81.

Troubleshooting

Is anything unusual displayed on the monitor?

Yes

There may be a problem with the system unit if:

- An error message appears. Find the error message in the section "Responding to error codes" on page 59 and take the action listed.
- A line containing an error code and message appears. Follow the instructions in the message. For instructions on using the Setup Utility, see "Using the Setup Utility" on page 73.
- A blinking cursor appears. See "HelpWare support and services" on page 81 for information on obtaining service.
- The image on the screen is unreadable (the image is scrolling, blinking, or flashing). You may have selected a monitor setting that your monitor does not support. Follow these steps to reconfigure your monitor:
 - a. Restart the computer. If necessary, turn off the system unit, pause for 15 seconds, and then turn the system back on.
 - b. When you see "Starting Windows" appear on the screen during startup, press **F8**. This opens the Microsoft Windows 98 Startup Menu.
 - c. Select Choice 3 for Safe Mode and press **Enter**. This starts your computer using the Windows factory configuration settings.
 - d. When your computer has completed startup, double-click the **My Computer** desktop icon.



If any of these problems continue after taking the actions listed, run the diagnostics programs that came with your computer. If you need service, see "HelpWare support and services" on page 81.

Is anything unusual displayed on the monitor?

- e. In the My Computer window, double-click the **Control Panel** icon.
 - f. In the Control Panel window, double-click the **Display** icon.
 - g. In the Display Properties window,
 - i. Click the **Settings** tab.
 - ii. Click the **Advanced...** button.
 - iii. Click the **Change...** button.
 - h. Choose a new monitor setting. If you need additional help, refer to the operating system help files or the instructions that came with the monitor.
 - i. Restart the computer again. Your computer may take a little longer than usual to restart.
- The colors displayed are wrong.
 - Make sure the monitor cable is correctly and securely connected to the system unit. The *Setup Poster* shows how the cable should be connected.
 - You may need to DeGauss your monitor. If the monitor you purchased came with a manual DeGauss feature, check the documentation that came with the monitor for information on how to use this feature.



If any of these problems continue after taking the actions listed, run the diagnostics programs that came with your computer. If you need service, see "HelpWare support and services" on page 81.

Troubleshooting

Is anything unusual displayed on the monitor?

Yes

- There may be a problem with the monitor.
 - a. Make sure your monitor cables are correctly and securely connected. The *Setup Poster* shows how the cables should be connected.
 - b. Adjust the brightness and contrast controls on the monitor. For instructions, refer to the documentation that came with your monitor.
- If you have added a video adapter card and disabled the onboard video controller, make sure that:
 - a. the monitor cable is properly connected to the new video adapter card and
 - b. the BIOS is configured to use the adapter card as the primary video adapter. For information about BIOS options, see the Configuration topic in the Aptiva online help if the display of the monitor is still viewable.
- There may be a problem with the battery on your system board. For instructions on how to replace the battery, see the Aptiva online help.



If any of these problems continue after taking the actions listed, run the diagnostics programs that came with your computer. If you need service, see "HelpWare support and services" on page 81.



Solving hardware problems

If the problem is...	Here's what to do...
Beep during Power-On Self Test (POST)	See the troubleshooting steps in the section titled "Did the system beep after it was turned on?" on page 34.
Screen is black (no error code)	If you <u>did not install memory modules or adapter cards</u> , see "HelpWare support and services" on page 81 for information on obtaining service.
Error code is displayed	If an error code is displayed, find the code in "Responding to error codes" on page 59 and take the action listed.
Computer appears to have turned off without warning	<ol style="list-style-type: none"> 1 If the Standby feature is enabled, press the On/Off button on the front of the system unit. 2 Make sure that the system unit and monitor power cords are securely plugged into electrical outlets. 3 Make sure that the cables are correctly and securely connected to the system unit. 4 Check for a blown fuse, tripped circuit breaker, or power failure. 5 Unplug the system power cord from the electrical outlet, wait 15 seconds, and then plug the power cord back into the electrical outlet. If the computer does not start immediately, push the system On/Off button. 6 If you have added hardware inside the system unit, make sure that the power cable connectors are securely attached.



If any of these problems continue after taking the actions listed, run the diagnostics programs that came with your computer. If you need service, see "HelpWare support and services" on page 81.

Troubleshooting

If the problem is...	Here's what to do...
Can't enter password	<ol style="list-style-type: none"> 1 Make sure that the keyboard is on. During the Power-On-Self-Test (POST), the keyboard lights will flash and the Num Lock light will remain on during and after the Power-On-Self-Test (POST). 2 Make sure that you typed the correct password. 3 Make sure the keyboard cable is correctly and securely connected to the keyboard port (not the mouse port) on the back of the system unit. The keyboard port has a grey label and this symbol next to it: 
Can't read information on diskette, CD, DVD or Zip Disks	<ol style="list-style-type: none"> 1 Make sure you are using the correct type of diskette and that it is formatted correctly. 2 Make sure the diskette, CD, DVD or Zip disk is inserted into the drive correctly. 3 Make sure the CD is clean and not scratched. 4 Try to use a diskette, CD, DVD or Zip disk that you know is good. If it works, the first diskette, CD, DVD or Zip disk may be damaged. If you can't read the information on the good diskette, CD, DVD or Zip disk, there may be a problem with your drive. 5 Make sure the power and signal cables are securely attached to the back of the drive. For instructions on working with drives, see the Aptiva online help. 6 Make sure the correct diskette drive is selected and the diskette drive is enabled in the Setup Utility. For information about Setup Utility options, see the Aptiva online help.
	<p><i>If any of these problems continue after taking the actions listed, run the diagnostics programs that came with your computer. If you need service, see "HelpWare support and services" on page 81.</i></p>

If the problem is...	Here's what to do...
Can't send information (write) to diskette or Zip disk	<ol style="list-style-type: none">1 Make sure you are using the correct type of disk and that it is formatted correctly.2 Make sure the disk is not write-protected.3 Make sure you are sending information to the correct drive.4 Make sure there is space on the disk for the information. (Try using a blank, formatted disk.)5 Try to write to a diskette that you know is good. If it works, the first diskette is damaged. If you can't write the information on the good diskette, there may be a problem with your diskette drive.6 Make sure the power and signal cables are securely attached to the back of the drive. For instructions on working with drives, see the Aptiva online help.7 Make sure the correct diskette drive is selected and the diskette drive is enabled in the Setup Utility. For information about Setup Utility options, see the Aptiva online help.
Can't format diskette	<ol style="list-style-type: none">1 Make sure the diskette is not write-protected.2 Make sure you are using the correct type of diskette.3 Make sure the power and signal cables are securely attached to the back of the drive. For instructions on working with drives, see the Aptiva online help.4 Make sure the correct diskette drive is selected and the diskette drive controller is enabled in the Setup Utility. For information about Setup Utility options, see the Aptiva online help.
	<p><i>If any of these problems continue after taking the actions listed, run the diagnostics programs that came with your computer. If you need service, see "HelpWare support and services" on page 81.</i></p>

Troubleshooting

If the problem is...	Here's what to do...
When the computer is turned on, the message "Insert a system diskette and press Enter to reboot" appears.	<ol style="list-style-type: none"><li data-bbox="659 562 1209 625">1 Remove any diskette from the diskette drive and restart your computer.<li data-bbox="659 627 1261 814">2 Restart your computer and use the Setup Utility to make sure that startup devices are set correctly. Make sure the Disk Drive options for the drives you have designated as startup devices are set correctly. For information about starting the Setup Utility, see "Starting the Setup Utility" on page 74.<li data-bbox="659 816 1242 909">3 Make sure the power and signal cables are securely attached to the back of the hard disk drive in the system unit.<li data-bbox="659 911 1261 1098">4 Insert the <i>Product Recovery</i> disc into the CD or DVD drive and press Ctrl + Alt + Delete. Follow the instructions on the screen to restore the operating system files to your computer's hard disk drive. In some cases, this recovery process formats your hard disk drive, erasing all files.<li data-bbox="659 1100 1226 1234">5 If you are not able to restore the operating system files to your computer's hard disk drive, see "HelpWare support and services" on page 81 for information on obtaining service.



If any of these problems continue after taking the actions listed, run the diagnostics programs that came with your computer. If you need service, see "HelpWare support and services" on page 81.

If the problem is...	Here's what to do...
Audio disc does not automatically play when inserted into CD or DVD drive	<p>Make sure you have enabled AutoPlay. To enable AutoPlay, follow these steps:</p> <ol style="list-style-type: none">1 From the Windows desktop, double-click the My Computer icon.2 In the My Computer window, double-click the Control Panel folder.3 In the Control Panel window, double-click the System icon.4 In the System Properties window, click the Device Manager tab.5 Double-click the CD-ROM or DVD-ROM list item and then double-click the listed CD-ROM option.6 In the Properties window, click the Settings tab.7 Under Options, click the Auto insert notification check box to add a check to the box.8 Click OK.
	<p><i>If any of these problems continue after taking the actions listed, run the diagnostics programs that came with your computer. If you need service, see "HelpWare support and services" on page 81.</i></p>

Troubleshooting

If the problem is...**Here's what to do...****Keyboard doesn't work or only some keys work**

- 1 Make sure the keyboard cable is correctly and securely connected to the keyboard port (not the mouse port) on the back of the system unit.

The keyboard port has a grey label and this symbol next to it:



- 2 Move your fingers across all of the keys. Make sure no keys are stuck.
- 3 Make sure that you have not disabled keys like the Rapid Access keys.
- 4 Make sure you are using a program that allows typing. Some programs do not.
- 5 Turn off the system, wait 15 seconds, and then turn the system on again.



If any of these problems continue after taking the actions listed, run the diagnostics programs that came with your computer. If you need service, see "HelpWare support and services" on page 81.

If the problem is...**Here's what to do...****Mouse does not move the cursor**

- 1 Move the mouse onto a mouse pad (or a similar surface) and try using it.
- 2 Make sure you are using a program that allows the use of a mouse. Some programs do not.
- 3 Make sure the mouse cable is correctly and securely connected to the mouse port (not the keyboard port) on the back of the system unit.
The mouse port has a green label and this symbol next to it: 
- 4 Turn off the system, wait 15 seconds, and then turn the system on again.
- 5 Clean the mouse. To clean the mouse, follow these steps:
 - a. Turn off the computer.
 - b. Disconnect the mouse cable from the system unit.
 - c. Turn the mouse upside down. Unlock the retainer on the bottom of the mouse by turning it counterclockwise. Now turn the mouse right side up, and the retainer and the ball will drop out.
 - d. Using a damp cloth, wipe the outside of the mouse and the retainer. Be sure to wipe the rollers inside the mouse.
 - e. Insert the ball and retainer. Lock the retainer by turning it clockwise.
 - f. Reconnect the mouse cable to the system unit.
 - g. Turn the computer on.



If any of these problems continue after taking the actions listed, run the diagnostics programs that came with your computer. If you need service, see "HelpWare support and services" on page 81.

Troubleshooting

If the problem is...	Here's what to do...
ScrollPoint Mouse does not scroll windows	Make sure the program supports the scrolling mouse. Some programs do not.
Modem / communications errors	<ol style="list-style-type: none"> 1 Make sure the telephone cord is securely connected. The <i>Setup Poster</i> shows how the cord should be connected. 2 Make sure the telephone line works by plugging a working telephone into the same telephone outlet that the computer was plugged into. Then make sure you can place a call. 3 Make sure you are calling the correct number, and that you are using the correct communications settings. For additional help, refer to the documentation for your communications software. 4 Make sure no one is using the telephone while you are communicating with another computer. 5 If some communications programs work but others do not, there may be a configuration problem. For additional help, refer to the documentation for your communications software. 6 Make sure your modem cord is connected to an analog telephone line. The local telephone company can help you determine the type of telephone line. 7 Make sure the modem adapter card is installed correctly. For instructions on working with adapter cards, see the Aptiva online help.



If any of these problems continue after taking the actions listed, run the diagnostics programs that came with your computer. If you need service, see "HelpWare support and services" on page 81.

If the problem is...	Here's what to do...
Printer error	<ol style="list-style-type: none">1 Make sure the printer is turned on.2 Make sure the printer cable is correctly and securely connected to the printer and to the parallel (printer) port on the back of the system unit. The parallel port has this symbol next to it: 3 Make sure the printer power cord is securely connected to an electrical outlet.4 Make sure the printer is ready for printing. (On some printers, if the ready light is on, but not flashing, the printer is ready.)5 If a printer driver is required, make sure the correct printer driver is selected in the software. For instructions on selecting a printer driver, see the online help files that came with the operating system.6 Make sure the paper and the cartridge containing the print material (ink, ribbon, or toner) are loaded correctly.7 Turn off the printer and computer and wait 15 seconds. Then turn on the printer first, followed by the computer.8 If you are printing from Windows, look in the Device Manager to see if any error symbols appear for the port used by the printer. For information on Device Manager, see the online help files that came with the operating system.9 If you are printing from DOS, make sure the Parallel Port option is not disabled in the Setup Utility. For information about Setup Utility options, see the Configuration topic in the Aptiva online help.



If any of these problems continue after taking the actions listed, run the diagnostics programs that came with your computer. If you need service, see "HelpWare support and services" on page 81.

Troubleshooting

If the problem is...

Here's what to do...

Printer error

10 Make sure the Parallel Port Mode option in the Setup Utility is set to a mode that matches your printer. For information about Setup Utility options, see the Configuration topic in the Aptiva online help.

11 If you have other devices connected to the parallel port, disconnect them and connect only the printer. Try to print again.

12 Avoid using a printer cable that is more than 6 feet long.
For additional help, refer to the documentation that came with the printer.



If any of these problems continue after taking the actions listed, run the diagnostics programs that came with your computer. If you need service, see "HelpWare support and services" on page 81.

Solving software problems

If the problem is...

Here's what to do...

Computer does not go on Standby

The following steps can be tried on systems that exit Standby when the system detects motion of the keyboard, mouse or drives:

- 1 Make sure you don't touch the mouse or keyboard, and don't start a program that involves using the modem or drives. These activities reset the timer.
- 2 Make sure you leave the mouse on a surface that does not vibrate. Leaving the mouse on top of your computer or on top of another machine may reset the timer before the set time has elapsed.
- 3 Allow a few minutes more than the specified time. Windows periodically accesses the hard disk drive for memory swapping and this activity resets the timer. Windows might access the hard disk drive for a short time after you last touched your computer.
- 4 Try disabling AutoPlay of the CD or DVD drives. When AutoPlay is enabled, the Power Management software may detect activity in the CD or DVD drive and keep the computer from going on Standby. For information about CD and DVD drive checking, see the Configuration topic in the Aptiva online help.



Periodically use the IBM Update Connector to look for available updates for the software that came from the factory with your computer. For information about the IBM Update Connector, see the Aptiva online help.

If any of these problems continue after taking the actions listed, run the diagnostics programs that came with your computer. If you need service, see "HelpWare support and services" on page 81.

Troubleshooting

If the problem is...	Here's what to do...
The system does not turn off when you press the on/off switch.	<ol style="list-style-type: none"> 1 If running Windows, check the Power Management utility of the Control Panel. The system should behave according to this setting. 2 If you are outside Windows (for example, in DOS), you may need to hold the On/Off button for 4-seconds to turn the power off. 3 Enter the Setup Utility and select Power Management. Ensure that the "Power Switch<4 sec." is set to Power Off.
The system does not go into suspend when you press the on/off switch.	<ol style="list-style-type: none"> 1 If running Windows, check the Power Management utility of the Control Panel. The system should behave according to this setting. 2 Enter the Setup Utility and select Power Management. Ensure that the "Power Switch<4 sec." is set to Standby.
The phone rings and the computer comes out of Standby, but a fax isn't received	<ul style="list-style-type: none"> • The fax software must be open and set to receive faxes. Refer to the documentation that came with your fax software to make sure it is set up to answer the phone. • In some cases, the computer may require additional rings before a fax is received. Allow the phone to ring a few more times. • Check the Wake Up On Ring cable from the modem to the system board to ensure it is securely attached (not all systems require this cable).



Periodically use the IBM Update Connector to look for available updates for the software that came from the factory with your computer. For information about the IBM Update Connector, see the Aptiva online help.

If any of these problems continue after taking the actions listed, run the diagnostics programs that came with your computer. If you need service, see "HelpWare support and services" on page 81.

If the problem is...	Here's what to do...
The computer won't come out of Standby on Wake Up On Ring	<ol style="list-style-type: none"> 1 Check the Wake Up On Ring cable from the modem to the system board to ensure it is securely attached (not all systems require this cable). 2 The modem software must be open when you put your computer on Standby.
The computer won't take a message out of Standby	<ol style="list-style-type: none"> 1 Check the Wake Up On Ring cable from the modem to the system board to ensure it is securely attached (not all systems require this cable). 2 The answering machine software must be open and set to receive messages. (Not all systems contain the hardware and software required to receive voice messages.)
You pressed the system On/Off button, but the computer has not turned off	<ul style="list-style-type: none"> • Press the On/Off button on the front of the system unit and hold it for 4-seconds. • If the computer does not turn off after 5 minutes, see "HelpWare support and services" on page 81 for information on obtaining service.
	<p><i>Periodically use the IBM Update Connector to look for available updates for the software that came from the factory with your computer. For information about the IBM Update Connector, see the Aptiva online help.</i></p> <p><i>If any of these problems continue after taking the actions listed, run the diagnostics programs that came with your computer. If you need service, see "HelpWare support and services" on page 81.</i></p>

Troubleshooting

Solving monitor problems

If the problem is...	Here's what to do...
Discolored screen	<ol style="list-style-type: none"> 1 Make sure that your monitor controls are adjusted correctly. 2 Move the monitor away from any equipment that might cause magnetic interference; for example, other monitors, external audio speakers, or microphones. (Some models of the computer come with microphones and speakers, which are shielded to prevent magnetic interference.) Turn off the monitor, wait 30 minutes, and then turn on the monitor again. 3 Select a new color palette setting. For instructions on working with color palette settings, see the online help files that came with the operating system. 4 Make sure the monitor cable is correctly and securely connected to the system unit. 5 If another monitor is available, connect it to your system unit. If the problem is corrected, something may be wrong with your monitor. 6 You may need to DeGauss your monitor. If the monitor you purchased came with a manual DeGauss feature, check the documentation that came with the monitor for information on how to use this feature.
Picture shape on monitor screen is poor	Adjust the monitor controls. For instructions, refer to the documentation that came with the monitor.
	<i>If any of these problems continue after taking the actions listed, refer to the documentation that came with your monitor. If you need service, see "HelpWare support and services" on page 81.</i>

If the problem is...	Here's what to do...
Display fonts appear cut off or pushed together	While your monitor resolution may let you change the font size, some programs do not support large fonts. Large fonts may cause words to appear cut off or pushed together. Check the display properties settings to verify that small fonts are selected. For instructions on working with display properties, see the online help files that came with the operating system.
White screen	<ol style="list-style-type: none"> 1 Make sure the monitor cable is correctly and securely connected to the system unit. 2 Make sure the system is turned on. 3 If another monitor is available, connect it to your system unit. If the problem is corrected, something may be wrong with your monitor.
Flickering or unsteady picture on monitor screen	<ol style="list-style-type: none"> 1 Select display settings for a lower resolution, fewer colors, or a higher refresh rate. For instructions on working with display properties, see the online help files that came with the operating system. 2 If your monitor is located close to another monitor, move the two monitors farther away from each other.
Screen is an intense yellow, magenta (purple or red-blue), or cyan (blue-green) color	Refer to the documentation that came with your monitor. If you need service, see "HelpWare support and services" on page 81.
	<i>If any of these problems continue after taking the actions listed, refer to the documentation that came with your monitor. If you need service, see "HelpWare support and services" on page 81.</i>

Troubleshooting

If the problem is...	Here's what to do...
Adjustments from earlier use were not saved	You may have selected more user-definable modes than the monitor can save. When this occurs, the newest mode replaces the oldest mode. Use the monitor controls to adjust the image for the display mode you are using.
Any of the following: <ul style="list-style-type: none"> • Totally blank screen • No cursor is displayed • Only the cursor is displayed • Screen is unreadable • Other monitor problems 	<ol style="list-style-type: none"> 1 If you have enabled the Standby feature, press the power button on the front of the system unit to take your system out of Standby. 2 Make sure the monitor cable is correctly and securely connected to the system unit. 3 Make sure the system unit and monitor power cords are securely plugged into electrical outlets. 4 Make sure the system and monitor are turned on. (The power lights on the computer and the monitor are lit when the power is on.) 5 Adjust the monitor controls. 6 Change the background colors in your software program or try using a different software program. 7 Unplug the system power cord from the electrical outlet, wait 15 seconds, and then plug the power cord back into the electrical outlet. Restart the computer.
	<i>If any of these problems continue after taking the actions listed, refer to the documentation that came with your monitor. If you need service, see "HelpWare support and services" on page 81.</i>

Solving audio, multimedia, and modem problems

If the problem is...	Here's what to do...
You installed new speakers and the audio is low or distorted	If your system is a machine type 2158 and you installed amplified speakers, read the "Installing amplified speakers" topic in the Aptiva online help to learn about the required jumper change to the system board.
You don't hear sound in Windows	<ol style="list-style-type: none"> 1 Check your computer's volume controls. See the online help files that came with the operating system for information about setting volume. 2 Make sure your speakers are connected properly. If your speakers have a power light, make sure the light is lit. For instructions on connecting your speakers, refer to the <i>Setup Poster</i> or the instructions that came with your speakers. 3 Make sure the program you are using is designed for use in Windows. If the program is designed to run in DOS, it does not use Windows sound features and must be configured to use SoundBlaster Pro or SoundBlaster emulation.
	<p><i>If any of these problems continue after taking the actions listed, refer to any documentation that may have come with your modem and sound cards. If you find no solution there, run the diagnostics programs that came with your computer. If you need service, see "HelpWare support and services" on page 81.</i></p>

Troubleshooting

If the problem is...	Here's what to do...
You don't hear sound when you play DOS games or use DOS programs	<ol style="list-style-type: none"> 1 Make sure the game or program is configured to use SoundBlaster Pro or SoundBlaster emulation. Refer to the documentation that came with your DOS program for instructions on selecting sound card settings. 2 Refer to the Aptiva help for information on running your DOS game or program in DOS mode. 3 Shut down and restart your computer in MS-DOS mode. Then try to run the program again.
Joystick or gamepad does not work or does not work properly	<ol style="list-style-type: none"> 1 Make sure that the joystick or gamepad is properly connected to the computer. 2 You may need to recalibrate the joystick or gamepad. You can recalibrate a joystick or gamepad in the Joystick section of the Windows Control Panel. 3 Refer to the documentation that came with the joystick or gamepad for additional troubleshooting information.
	<p><i>If any of these problems continue after taking the actions listed, refer to any documentation that may have come with your modem and sound cards. If you find no solution there, run the diagnostics programs that came with your computer. If you need service, see "HelpWare support and services" on page 81.</i></p>

If the problem is...	Here's what to do...
When you try to use the modem, your communications program is unable to detect the modem	<ol style="list-style-type: none"><li data-bbox="656 562 1187 621">1 If you added a modem, make sure it is installed properly.<li data-bbox="656 625 1187 716">2 Make sure your communications program is configured correctly. The following settings are suggested for compatibility:<ul data-bbox="656 720 1057 982" style="list-style-type: none"><li data-bbox="656 720 824 751">• Modem type:<ul data-bbox="678 753 1057 982" style="list-style-type: none"><li data-bbox="678 753 997 785">• Generic Hayes-type modem<li data-bbox="678 787 1057 819">• Hayes compatible error correcting<li data-bbox="678 821 1013 852">• Hayes compatible high speed<li data-bbox="678 854 922 886">• User-defined modem<li data-bbox="678 888 980 919">• Hayes SmartModem 2400<li data-bbox="678 921 850 953">• Hayes modem<li data-bbox="678 955 760 987">• Other<p data-bbox="678 991 1250 1081">If you select a modem type of Other, you must include the proper modem initialization string. For most programs, the initialization string <code>AT&F</code> will work.</p><ul data-bbox="656 1085 1224 1241" style="list-style-type: none"><li data-bbox="656 1085 1224 1176">• Baud rate:<ul data-bbox="678 1119 1224 1176" style="list-style-type: none"><li data-bbox="678 1119 1224 1176">• 115,200 Kbps or the maximum setting offered by your communications software<li data-bbox="656 1180 797 1241">• COM port:<ul data-bbox="678 1213 764 1241" style="list-style-type: none"><li data-bbox="678 1213 764 1241">• COM1
	<p data-bbox="678 1272 1250 1463"><i>If any of these problems continue after taking the actions listed, refer to any documentation that may have come with your modem and sound cards. If you find no solution there, run the diagnostics programs that came with your computer. If you need service, see "HelpWare support and services" on page 81.</i></p>

Troubleshooting

If the problem is...	Here's what to do...
Can't use second modem	<p>If you added a second modem:</p> <ul style="list-style-type: none"> • Make sure that the telephone line is connected to the modem you want to use. • Make sure that the communications software you are using is properly configured to use the second modem. • Make sure that the second modem is properly configured. A second modem must use a different COM port and system IRQ from the first modem.
When you try to use the modem, your computer or modem is unable to detect a dial tone	<ol style="list-style-type: none"> 1 Make sure the telephone line is correctly connected to your computer. For instructions on connecting your computer to the telephone network, refer to the <i>Setup Poster</i>. 2 Make sure the telephone line is working. 3 Add the modem command <code>x3</code> to the initialization string for the communications program you are using. For help with changing the initialization string, refer to the documentation that came with your communications program.
	<p><i>If any of these problems continue after taking the actions listed, refer to any documentation that may have come with your modem and sound cards. If you find no solution there, run the diagnostics programs that came with your computer. If you need service, see "HelpWare support and services" on page 81.</i></p>

Solving DVD problems

If the problem is...	Here's what to do...
Black screen instead of DVD video	<ol style="list-style-type: none"> 1 Restart the DVD player program. 2 Close any open files, shut down Windows, and restart your computer.
DVD movie will not play	<ol style="list-style-type: none"> 1 Make sure that the disc surface is clean and not scratched. 2 Check the disc for regional coding. You may need to purchase a disc with coding for the region in which you are using your computer.
No audio or intermittent audio while playing DVD movie	<ol style="list-style-type: none"> 1 Check the volume control settings in Windows or on your speakers. 2 Make sure that the disc surface is clean and not scratched. 3 Check all cable connections to and from the speakers.
Playback is very slow or choppy	<ol style="list-style-type: none"> 1 Disable any background programs, such as AntiVirus or Desktop Themes. 2 Ensure that video resolution is set to less than 1024x768x16 bits.
	<p><i>If any of these problems continue after taking the actions listed, refer to any documentation that may have come with your modem and sound cards. If you find no solution there, run the diagnostics programs that came with your computer. If you need service, see "HelpWare support and services" on page 81.</i></p>

Troubleshooting

Responding to error codes

Error code and description	Here's what to do...
Screen is black (no error code)	If you added hardware, remove it and restart the computer to see if the problem is corrected. If the problem is corrected, you may have installed your hardware incorrectly. Reinstall your hardware.
Beep occurs in Power On Self Test (POST)	<ul style="list-style-type: none"> • If you <u>installed memory modules or adapter cards</u>, make sure you installed them correctly. • If you <u>did not install memory modules or adapter cards</u>, see "HelpWare support and services" on page 81 for information on obtaining service.
Press <Esc> to turn off NMI or other key to reboot	<ol style="list-style-type: none"> 1 Press Esc to turn off the Non-Maskable Interrupt (NMI) and proceed to boot the system. 2 Press any other key to reboot the system. <p>For information on the Setup Utility options, see the Aptiva online help.</p>
111 I/O Parity Error	Load the Setup default settings and reboot the system. For more information on using the Setup Utility, see "Using the Setup Utility" on page 73.
127 CPU Clock Mismatch	If you changed your processor, this is expected; otherwise, load the default settings in Setup. For more information on using the Setup Utility, see "Using the Setup Utility" on page 73.
151/163 Real Time Clock Error Date and time incorrect	Enter the Setup Utility and reset the date and time.
	<i>If any of these problems continue after taking the actions listed, run the diagnostics programs that came with your computer. If you need service, see "HelpWare support and services" on page 81.</i>

Error code and description	Here's what to do...
161 CMOS Battery is Bad	Load the Setup default settings and reset the date and time. If it reoccurs, replace the battery. For more information on using the Setup Utility, see "Using the Setup Utility" on page 73.
162 CMOS Checksum Error	Load the Setup default settings and reboot the system. Also, check the date and time. For more information on using the Setup Utility, see "Using the Setup Utility" on page 73.
162 Equipment Configuration Error	<ol style="list-style-type: none"> 1 This message appears together with other specific error messages indicating the device with an error. First, find the device error message in this table and do the corresponding action. 2 Enter the Setup Utility and change the required settings. For information on the Setup Utility options, see the Aptiva online help and the Setup Utility help.
164 Memory size changed	<p>If you removed the memory, this is expected. If you did not remove the memory, do the following:</p> <ol style="list-style-type: none"> 1 Make sure the DIMMs are properly installed, then reboot the system. 2 If you still receive the error message after doing option 1, the DIMMs may be defective. Change the DIMMs. For instructions on working with system board components, see the Aptiva online help.
	<i>If any of these problems continue after taking the actions listed, run the diagnostics programs that came with your computer. If you need service, see "HelpWare support and services" on page 81.</i>

Troubleshooting

Error code and description	Here's what to do...
201 Memory Error at MMMM:SSSS:0000h (R:xxxxh, W:xxxh)	<ol style="list-style-type: none"> 1 Make sure the DIMMs are properly installed, then reboot the system. 2 If you still receive the error message after doing option 1, the DIMMs may be defective. Change the DIMMs. For instructions on working with system board components, see the Aptiva online help.
301 PS/2 Keyboard Error or Keyboard Not Connected	<ol style="list-style-type: none"> 1 Plug in the keyboard properly and reboot the system. 2 If the error still shows after doing option 1, change your keyboard. It may be defective.
303 PS/2 Keyboard Interface Error	<ol style="list-style-type: none"> 1 Plug in the keyboard properly and reboot the system. 2 If the error still shows after doing option 1, change your keyboard. It may be defective.
648 Floppy Drive(s) Write Protected	<ol style="list-style-type: none"> 1 Make sure the diskette protection tab is set correctly. 2 Enter the Setup utility. Select Advanced Options then Security Options. Make sure that the Diskette Drive parameter is set to Normal. For information on using the Setup Utility, see "Using the Setup Utility" on page 73.
	<p><i>If any of these problems continue after taking the actions listed, run the diagnostics programs that came with your computer. If you need service, see "HelpWare support and services" on page 81.</i></p>

Error code and description	Here's what to do...
662 Floppy Disk Controller Error	Load the Setup default settings in the Setup Utility. For information on using the Setup Utility, see "Using the Setup Utility" on page 73.
662 Floppy Drive A Error	<ol style="list-style-type: none"> 1 Make sure that the Diskette Drive A parameter setting within the Setup Utility is correct. For information on Setup Utility options, see the Aptiva online help and the Setup Utility help. 2 Make sure the diskette drive signal cable is properly connected to the drive and to the system board. 3 Make sure the drive power cable is properly plugged in. 4 If the error still shows after doing steps 1 to 3, the diskette drive may be defective.
662 Onboard Floppy Drive Conflict(s)	<ol style="list-style-type: none"> 1 Remove all the add-on cards in the system. 2 Power on the system to see if it works without the cards. 3 Re-install the cards one by one to determine which of the cards caused the error. 4 After determining the defective card or cards, replace the cards. <p>For instructions on installing add-on cards, see the Aptiva online help.</p>
	<p><i>If any of these problems continue after taking the actions listed, run the diagnostics programs that came with your computer. If you need service, see "HelpWare support and services" on page 81.</i></p>

Troubleshooting

Error code and description	Here's what to do...
962 Onboard Parallel Port Conflict(s)	Enter the Setup Utility and do any of the following: <ul style="list-style-type: none"> • Change the onboard parallel port I/O address and IRQ or disable it. • Change the add-on card parallel port I/O address and IRQ then reboot the system. For information on the Setup Utility options, see the Aptiva online help.
1162 Onboard Serial Port Conflict(s)	Enter the Setup Utility and do any of the following: <ul style="list-style-type: none"> • Change the onboard serial port I/O address and IRQ or disable it. • Change the add-on card serial port I/O address and IRQ then reboot the system. For information on the Setup Utility options, see the Aptiva online help.
1755 Hard Disk Drive(s) Write Protected	Enter the Setup Utility and make sure that the Hard Disk Drive parameter setting is set to Normal . For information on the Setup Utility options, see the Aptiva online help.
	<i>If any of these problems continue after taking the actions listed, run the diagnostics programs that came with your computer. If you need service, see "HelpWare support and services" on page 81.</i>

Error code and description	Here's what to do...
----------------------------	----------------------

1762

**Onboard IDE Channel
Address Conflict(s)**

- 1 Remove all the add-on cards in the system.
- 2 Power on the system to see if it works without the cards.
- 3 Re-install the cards one by one to determine which of the cards caused the error.
- 4 After determining the defective card or cards, enter the Setup Utility and set the Reset Resource Assignments parameter setting to **Yes**, then reboot the system.
- 5 If the problem still shows, set the Onboard IDE Primary/Secondary Channel parameter to **Disabled**, then reboot the system.
For instructions on installing add-on cards, see the Aptiva online help.

1780

**IDE Primary Channel
Master Drive Error**

- 1 Make sure the IDE signal cable is properly connected to the drive and to the system board.
- 2 Make sure the drive power cable is properly connected.
- 3 Enter the Setup Utility and make sure that the IDE Primary Channel Master parameter setting is set to **Auto**. For information on the Setup Utility options, see the Aptiva online help and the Setup Utility help.
- 4 If the error still shows after performing the above steps, the IDE drive may be defective. For more information on using the Setup Utility, see "Using the Setup Utility" on page 73.



If any of these problems continue after taking the actions listed, run the diagnostics programs that came with your computer. If you need service, see "HelpWare support and services" on page 81.

Troubleshooting

Error code and description	Here's what to do...
1781 IDE Primary Channel Slave Drive Error	<ol style="list-style-type: none"> 1 Make sure the IDE signal cable is properly connected to the drive and to the system board. 2 Make sure the drive power cable is properly connected. 3 Enter the Setup Utility and make sure that the IDE Primary Channel Slave parameter setting is set to Auto. For information on the Setup Utility options, see the Aptiva online help and the Setup Utility help. 4 If the error still shows after performing the above steps, the IDE drive may be defective. For more information on using the Setup Utility, see "Using the Setup Utility" on page 73.
1782 IDE Secondary Channel Master Drive Error	<ol style="list-style-type: none"> 1 Make sure the IDE signal cable is properly connected to the drive and to the system board. 2 Make sure the drive power cable is properly connected. 3 Enter the Setup Utility and make sure that the IDE Secondary Channel Master parameter setting is set to Auto. For information on the Setup Utility options, see the Aptiva online help and the Setup Utility help. 4 If the error still shows after performing the above steps, the IDE drive may be defective. For more information on using the Setup Utility, see "Using the Setup Utility" on page 73.
	<p><i>If any of these problems continue after taking the actions listed, run the diagnostics programs that came with your computer. If you need service, see "HelpWare support and services" on page 81.</i></p>

Error code and description	Here's what to do...
1783 IDE Secondary Channel Slave Drive Error	<ol style="list-style-type: none"> 1 Make sure the IDE signal cable is properly connected to the drive and to the system board. 2 Make sure the drive power cable is properly connected. 3 Enter the Setup Utility and make sure that the IDE Secondary Channel Slave parameter setting is set to Auto. For information on the Setup Utility options, see the Aptiva online help and the Setup Utility help. 4 If the error still shows after performing the above steps, the IDE drive may be defective. For more information on using the Setup Utility, see "Using the Setup Utility" on page 73.
1800 IRQ Setting Error PnP ISA Card(s) Disabled	<ol style="list-style-type: none"> 1 Enter the Setup Utility and set the Reset Resource Assignments to Yes, then reboot the system. 2 If the error message reappears, determine which onboard device is least necessary and disable it under the Input/Output Ports menu in Setup. For information on the Setup Utility options, see the Aptiva online help and the Setup Utility help.
1801 Expansion ROM Allocation Failed	<ol style="list-style-type: none"> 1 Enter the Setup Utility and set the Reset Resource Assignments to Yes, then reboot the system. 2 Change the I/O expansion ROM address. For information on the Setup Utility options, see the Aptiva online help and the Setup Utility help.
	<p><i>If any of these problems continue after taking the actions listed, run the diagnostics programs that came with your computer. If you need service, see "HelpWare support and services" on page 81.</i></p>

Troubleshooting

Error code and description	Here's what to do...
1802 I/O Resource Conflict(s)	<ol style="list-style-type: none"> 1 Enter the Setup Utility and set the Reset Resource Assignments to Yes, then reboot the system. For information on the Setup Utility options, see the Aptiva online help and the Setup Utility help. 2 If the error message reappears, determine which onboard device is least necessary and disable it under the Input/Output Ports menu in Setup. For information on the Setup Utility options, see the Aptiva online help and the Setup Utility help.
1803 Memory Resource Conflict(s)	<ol style="list-style-type: none"> 1 Enter the Setup Utility and set the Reset Resource Assignments to Yes, then reboot the system. For information on the Setup Utility options, see the Aptiva online help. 2 If the error message reappears, determine which onboard device is least necessary and disable it under the Input/Output Ports menu in Setup. For information on the Setup Utility options, see the Aptiva online help.
	<p><i>If any of these problems continue after taking the actions listed, run the diagnostics programs that came with your computer. If you need service, see “HelpWare support and services” on page 81.</i></p>

Error code and description	Here's what to do...
1962 Insert system diskette and press <Enter> to reboot	<ol style="list-style-type: none">1 Insert a system diskette into drive A and press Enter to reboot the system.2 If the system works when you boot from drive A, your hard disk may have a problem.3 Make sure that your hard disk is properly installed. Check all cable connections. For information on the Setup Utility options, see the Aptiva online help and the Setup Utility help.
8601/8603 PS/2 Pointing Device Interface Error	<ol style="list-style-type: none">1 Make sure that the mouse is plugged in the PS/2 mouse port, then reboot the system.2 If the error still shows after doing option 1, replace the PS/2 mouse. It may be defective.
	<p><i>If any of these problems continue after taking the actions listed, run the diagnostics programs that came with your computer. If you need service, see "HelpWare support and services" on page 81.</i></p>

Troubleshooting

Recovering factory installed programs and files



Note

Some models ship with the ConfigSafe program, which runs in the background. ConfigSafe automatically takes a snapshot of your configuration files. Before doing a full recovery, you may want to open ConfigSafe to see if restoring system files to an earlier snapshot might fix your problem.

Your Aptiva PC came with programs and files installed on the hard disk drive. These programs and files are also included on the *Product Recovery and Diagnostics CD-ROM* disc. In some cases, the original programs and files on the hard disk drive can become corrupted. If this happens, you will need to reinstall them on the hard disk drive.

You may also install programs and create your own files. When you install programs, the installation process can change certain configuration files that the operating system uses. You should make regular backup copies of these configuration files and any files you created. For information on backing up files, see the Aptiva online help.

When you make backup copies of the operating system configuration files, you should copy the original directory structure. When you reinstall the files, you must put them into the original directory structure. If you do not, the computer may not work properly.

To recover the factory installed system and program files, follow these steps:

Note: All personal data in the computer will be lost.

- 1 Make sure your computer is turned on.
- 2 Make backup copies of configuration files and any files you created.
- 3 Insert the *Product Recovery and Diagnostics CD-ROM* disc into your CD or DVD drive.
- 4 Make sure you do not have a diskette, CD, or DVD in any other drive.
- 5 Shut down and turn off your computer.

- 6 Wait 15 seconds.
- 7 Turn on your monitor and computer.
- 8 When you see the Aptiva Product Recovery message, read and follow the instructions on the screen.
- 9 Remove the disc before you restart your computer at the end of the recovery.
- 10 After the Aptiva software has been reinstalled, copy your personal configuration and data files back into their original directories on the hard disk drive.

If you need to use the *Product Recovery and Diagnostics CD-ROM* disc, you should make sure that the Setup Utility is set up to use the CD or DVD drive before the hard disk. The CD or DVD drive is set at the factory as the first startup device. For more information about selecting startup devices in the Setup Utility, see the Setup Utility help.

Setup Utility





Setup Utility

Your IBM Aptiva Personal Computer comes ready to use. You can use the Setup Utility and the Windows Device Manager to view your computer's configuration settings.

You can also use the Setup Utility to change some configuration settings. If you add or replace hardware inside your computer, you might need to verify or update specific settings.

This chapter contains instructions for how to use the Setup Utility. If you need additional information about the Setup Utility options, see the Setup Utility help.

Using the Setup Utility

The Setup Utility lets you view and change configuration settings for hardware installed in your computer. You might need to use the Setup Utility if you upgrade the hardware in your computer or if you get an error message while using your computer.

Automatic changes

In most cases, your computer's Basic Input/Output System (BIOS) can make changes automatically. When you install new hardware, the BIOS detects it during the Power On Self Test (POST) and automatically updates the Setup Utility.

Manual changes

In some cases, your computer will not make changes automatically. For example, if you install hardware that does not meet Plug and Play requirements, you will need to start the Setup Utility and make changes manually.

The Setup Utility includes the following hardware and configuration information:

- Processor speed
- System, cache, and video memory
- Disk drives
- Serial and parallel ports
- Power Management features
- Plug and Play and PCI resource assignments
- Startup options
- Model information
- Date and time
- Security options

You will not be able to change some Setup Utility options like system and model information because they contain information about the system. Other options let you control how your computer operates. For example, you can use the Setup Utility to:

- Create or change a power-on password.
- Reduce energy consumption with Power Management features.
- Enable or disable the system memory test.

Starting the Setup Utility

Sometimes, when you get an error message, your computer displays a message window with an error code and a description of the problem. When this occurs, you can press the **F1** key to start the Setup Utility. Otherwise, to access the Setup Utility, you must either start or restart your computer.

Setup Utility

To start the Setup Utility when your computer is on, follow these steps:

- 1 Save all open files and close all software programs.
- 2 Click the **Start** button on your Windows desktop.
- 3 Click the **Shut Down** option.
- 4 From the Shut Down Windows window, click **Restart the computer** and then click the **Yes** button.
- 5 When the following screen appears, press the **F1** key:



To start the Setup Utility when your computer is off, follow these steps:

- 1 Turn on your monitor.
- 2 Turn on your system.

3 When the following screen appears, press the **F1** key:



The Setup Utility Main Menu appears:



Note

The Main Menu you see on your computer may look slightly different from the menu shown here, but it will operate the same way.

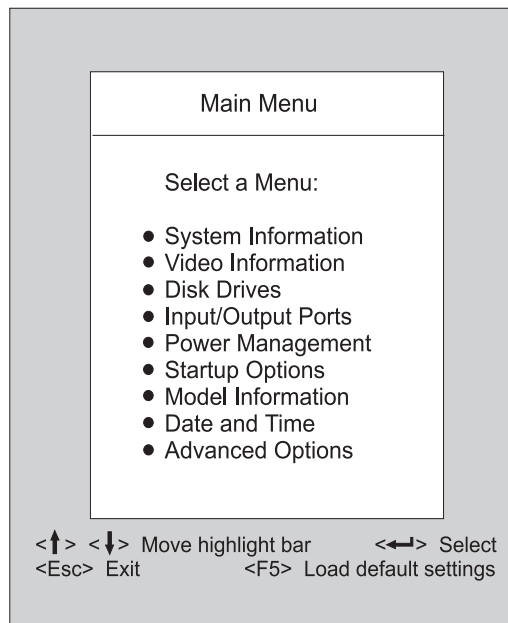

Setup Utility

Working with the Setup Utility menus

The Setup Main Menu lists system configuration options. When you select one of these options, a menu for that option appears.

To move through menus, use the following keys:

Keys	Function
↑ ↓	Use these arrow keys to highlight an option on the menu. (Press the Enter key to choose the option.)
← →	Use these arrow keys to make a selection and change an option's setting. On some menus, you can use these keys to move from one field to another.
Enter	Press this key to choose a highlighted option from a menu.
Esc	After viewing or making changes to the settings on a menu, press this key to exit the menu.
F1	Press this key if you want help for a selected item in a menu.
F5	Press this key if you want to load the factory default settings from the Main Menu.



Note

Not all keys on the list are available on every menu. The available keys appear on the bottom of that menu.

Viewing system information and model information

To view general hardware information about your computer, select the **System Information** option from the Setup Main Menu. The items displayed in the System Information menu are not configurable.

Setup automatically updates this menu when you do either of the following:

- Add or change hardware on your computer
- Make changes to other menus in Setup and save those changes

To view other computer information such as the model number, serial number, and the BIOS version and date, select the **Model Information** option from the Setup Main Menu. Like in the System Information menu, the items displayed are not configurable.

Changing parameter settings

In the Setup menus, all configuration information that you can change is enclosed in brackets like these: []. You cannot change any information that is not enclosed in brackets. Use the up- or down-arrow keys to highlight options then press **Enter** to display a menu. When changing the setting of a particular parameter, highlight the setting then use the left- or right-arrow key to change the setting. Refer to the Setup Utility help for details on the configurable parameters in each menu.

Loading the default settings

When you purchase an Aptiva computer, it is already configured for use. The original configuration settings, also called *factory* or *default settings*, are stored in the

Setup Utility

CMOS. Setup includes an option **Load default settings** that lets you reload the original configuration at any time.

To reload the default settings, follow these steps:

- 1 From the Main Menu, press **F5**. A dialog box appears confirming if you want to load the default settings.
- 2 Use the left arrow key to select **Yes**, then press **Enter**.
- 3 Press **Esc** to exit Setup. A dialog box appears saying "Do you want to save settings?"
- 4 Use the left arrow key to select **Yes**, then press **Enter** to save the changes in CMOS. You must load the Setup default settings in the following instances:
 - when you replace the system battery
 - when you customize your system configuration settings and some resource assignments conflict causing the computer to stop responding.

Exiting Setup

Press **Esc** to return to the Main Menu when you have finished viewing settings and making changes. From this location, you can exit Setup and save your changes or exit without saving your changes.

Follow these steps to exit setup:

- 1 From the Main Menu, press **Esc** to exit Setup.
- 2 Do either of the following:
 - If you would like to save your changes, press the left arrow key to select the option **Yes** then press **Enter** to save your changes and exit Setup.
 - If you do not want to save your changes, press the right arrow key to select the option **No** then press **Enter**, to exit Setup without saving.



HelpWare support and services

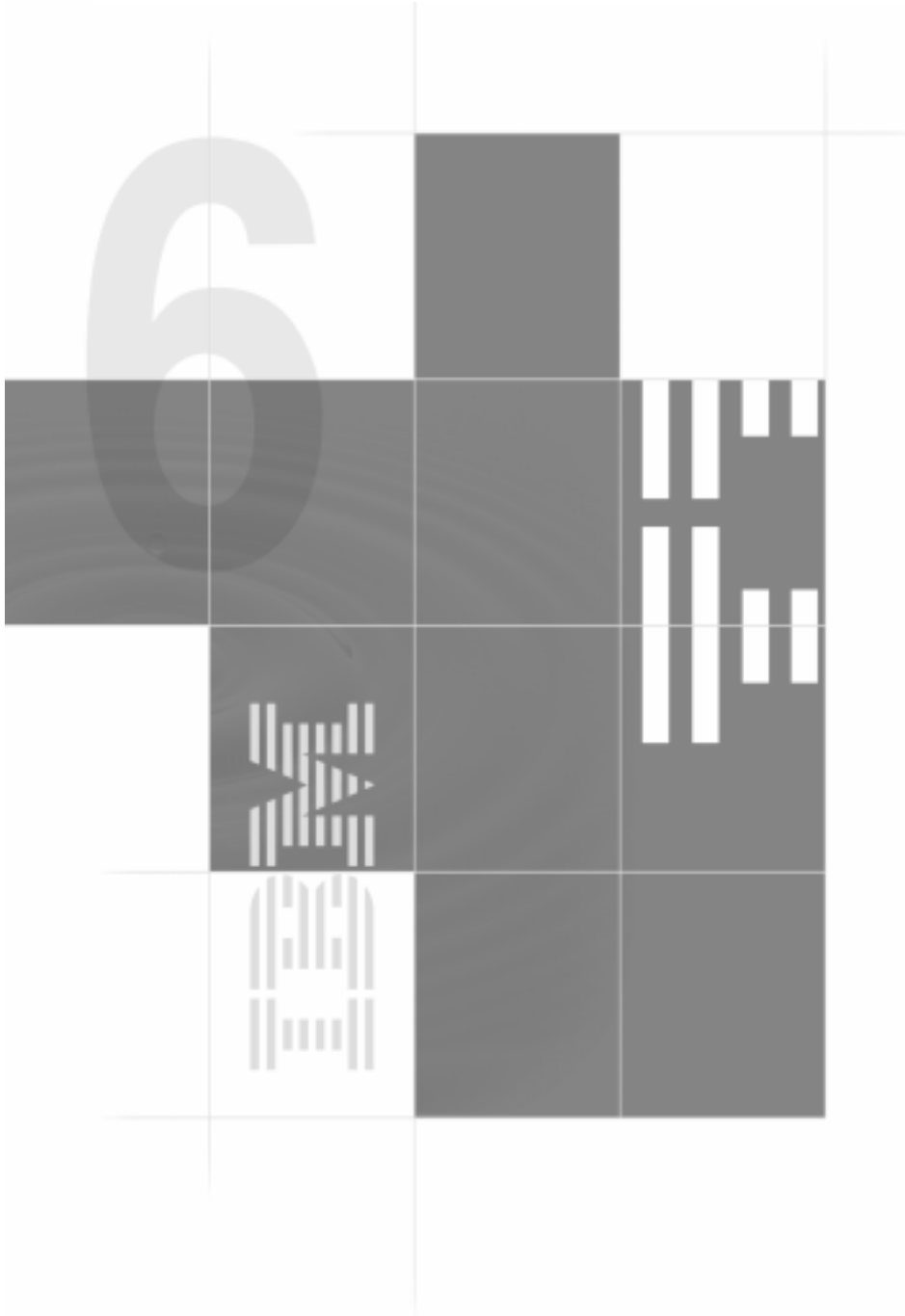



HelpWare support and services

What do I do first?

What is IBM HelpWare?

IBM HelpWare is a comprehensive set of technical support and service options. These include:

- 24-hour help, 365 days a year
- information by Internet, fax, and phone.

From 30-day "Up and Running" support to help with popular programs, IBM HelpWare has a variety of services and solutions for you. These options are available from IBM whenever you need help for as long as you own your IBM Aptiva Personal Computer. Even when your warranty period expires, HelpWare will still be there to support you with services available for purchase.

Read on to find out when and what methods of support are available at no additional charge and when charges will apply.

Need Quick Help?

There are two ways to get help quickly from IBM:

Internet	http://www.pc.ibm.com/us/aptiva/support
Telephone	Please refer to the section titled "How and when do I contact the IBM PC HelpCenter?" on page 87 for information about the telephone services of HelpWare.

What can I do on my own?

Sometimes you can quickly solve problems that you may have with your computer. We've given you several different methods you can use to solve problems on your own. If you need to, you can still contact IBM for support. There is more information about telephone support in the section titled "How and when do I contact the IBM PC HelpCenter?" on page 87.

Printed documentation. The documentation that came with your computer contains information about troubleshooting hardware and software problems. This information begins with the quick step-by-step guide on page 32 which can help you diagnose hardware and software problems. Once you know the nature of the problem, you can follow the instructions in the "Troubleshooting" section on page 29. Just match the description or error codes with your question and follow the instructions to solve the problem!

HelpWare support and services

Online documentation. Your computer also came with several online resources you can use to solve problems.

Help files. The operating system and most preloaded programs on your computer contain online Help files. The Aptiva online help contains information about upgrading hardware, using software, and many other common computer tasks. Help files may also contain information for questions on how to solve problems and prevent future trouble.

Readme files. Most operating systems and software programs also come with a file named README.TXT. This is a text file that contains important information about the program. You can read README.TXT files by opening them in any text file editor on your computer. If an Aptiva Readme file is provided, it is named APTIVA.TXT.

Software. Your computer came with several software programs which can help you solve problems or find answers to your questions.

Diagnostics. Your computer came with a diagnostic program which can help identify problems you may have with your computer. You can run the *PC Doctor* diagnostic program from *Access Aptiva* in Windows or the *Product Recovery and Diagnostics* disc.

IBM Update Connector. This program allows you to connect to the IBM PC HelpCenter to receive updates for some of the software that came with your system and download them. Once you have received the files, you can begin the automated installation process. IBM Update Connector is available to registered Aptiva customers during the warranty period at no additional charge. Telephone line charges may apply.

Aptiva Installer. This program allows you to easily install and uninstall software programs on your computer. If you install a program with *Aptiva Installer* and you begin

to have problems because of the program you added, you may be able to use the uninstall feature to cleanly erase all of the files related to the program.

How do I get help electronically?

Electronic support

There are many different ways to receive technical support and information if you have questions or problems. Electronic support is easy to use, quick, and very thorough. Best of all, the only charges that typically apply are the ones you pay to your telephone company or the company you use to log onto the World Wide Web. Here are some of the electronic support options that you can use.

Internet. You can use the Universal Resource Locator (URL) to contact us on the Internet. When you link to the IBM Aptiva PC support home page, you can search for technical tips, download update drivers and find out about many other things.

You can visit the IBM Aptiva PC support internet site at this URL:

<http://www.pc.ibm.com/us/aptiva/support>

Online services. Online services are companies which provide a wide variety of services like electronic mail, newsgroups, and special forums. These companies provide IBM forums where customers can receive technical support and information about IBM products.

America Online. If you want to use America Online to find information related to IBM products and services, use the "Go to" keyword **IBM connection**.

HelpWare support and services

Automated Fax. In the United States and Canada, if you have a touch-tone telephone and access to a fax machine, you can receive information by fax 24 hours a day, 7 days a week.

To access the Automated Fax System:

- In the United States, call 1-800-426-3395.
- In Canada, call 1-800-465-3299.

Follow the recorded instructions and the information you request will be sent to the fax machine you specify.

A catalog (approximately 40 pages) of Automated Fax topics is available.

How and when do I contact the IBM PC HelpCenter?

What help can I get by telephone?

Sometimes you may have a problem that you just can't solve and we understand that it can be frustrating. This document contains several problem-solving options you can use. See the "Quick step guide" on page 32 for troubleshooting information before you call the IBM PC HelpCenter. If you have completed the problem-solving steps in the "Troubleshooting" chapter and you still need help, you may need to call the IBM PC HelpCenter.

System experts are available to help answer your questions. Depending upon the type of problem, there may be charges for some calls and not for others. This section contains information about which calls you will be charged for and which calls you will not. You will be required to register your computer to receive telephone support.



Note

For help with installing or "how to" questions for software, see "How and when do I purchase additional support?" on page 91.

30-day "Up and Running" support. If you have questions about setting up your system, we're here to help. Within the first 30 days that you have your computer, you can call us at no additional charge to ask questions about:

- setting up your system and attaching a monitor and printer
- starting the preloaded operating system
- starting the preloaded and bundled software programs

Long distance telephone charges may apply. We will calculate the 30 days from the date of purchase.

Software technical support. If you need help setting up or installing the preloaded or bundled software programs during the 30-day "Up and Running" support period, technical support representatives will help you install (or reinstall) the software that came with your computer if necessary. HelpCenter technicians will ensure that the program is successfully loaded so that you can start the program. Support for your "how to" questions about software programs is available for a fee. For more information, see "How and when do I purchase additional support?" on page 91.

**Note**

Make sure you write down your date of purchase and keep your receipt in a safe place. You may be required to present your proof of purchase to receive service under your limited warranty.

Additional support. There are times you may need additional assistance after the 30-day "Up and Running" support period. You may also require "how to" help and support as you use your Aptiva PC. IBM PC HelpCenter technicians can assist you for a fee. For more information, see "How and when do I purchase additional support?" on page 91.

Hardware warranty service. In some cases, the Aptiva PC that you purchased may not function as warranted. If this happens, during the period of your warranty, the IBM PC HelpCenter will provide warranty service for IBM factory installed hardware.

HelpWare support and services

Your Aptiva is subject to the terms of the *IBM Statement of Limited Warranty and IBM Program License Agreement* which are included with your computer. Please read these terms carefully.

If your computer needs to be serviced, please provide the servicer with the Aptiva *Product Recovery* disc that came with your computer. This will help the servicer to complete the required service.

If your computer is having a problem that is not covered by the warranty, see "How and when do I purchase additional support?" on page 91.



Note

To find your machine and model type as well as your serial number, look on the front lower right corner of the system unit.

Before you call...

The information in the following three steps will provide the IBM PC HelpCenter technical support representative with valuable information that will assist him/her when handling your call. It will also help reduce the amount of time it takes to diagnose problems and answer questions.

- 1 Register your computer with the online IBM Registration form that came installed on your computer.
- 2 If you are able to run the *PC Doctor* diagnostics, locate the log file (the filetype will be named .log) and have it available for the technical support representative to review.
- 3 If you have not already done so, you will be required to register your computer the first time you contact IBM. You will be required to provide the following information:



Note

If your call is not covered by 30-day "Up and Running" support or the warranty, you will be required to provide a major credit card number for support.

Name

Address

Telephone number

Machine and model type:

Serial number:

Registration number:

(when you receive one)

Date of purchase:

- description of the problem
- exact wording of any error messages
- hardware and software configuration information for your system

If your call is not covered by 30-day "Up and Running" support or the Limited Warranty, you may be required to provide a major credit card number for support. You will not be billed if it is determined that your call is covered under "Up and Running" support or the Limited Warranty.

HelpWare support and services

Please be at your computer when you call.

HelpWare services are available 24 hours a day, 365 days a year (response times may vary).

- In the United States and Puerto Rico, call **1-919-517-2800**.
- In Canada, call **1-800-565-3344** (excluding holidays).
- In all other countries, contact your IBM reseller or IBM marketing representative for telephone numbers, services and hours of operation.

The support representative may also be able to fax or mail additional technical or product information to you, such as:

- sales information
- product brochures
- locations of IBM resellers
- services available through IBM

If you need help with a specific program or if you need help after your warranty has ended, these services are available for a fee. For more information about additional services, see "How and when do I purchase additional support?" below.

How and when do I purchase additional support?

Purchasing additional HelpWare services

During and after the warranty period for your computer, you can purchase additional HelpWare services. Our Enhanced PC Support service includes assistance with the following items:

- assistance with installing, configuring, and using selected software applications

- using the operating system
- tuning performance (e.g., memory management)
- setting up and using multimedia drivers
- installing and configuring out-of-warranty IBM PC products

You can purchase support in the following ways:

900 number. To receive immediate support from an IBM PC HelpCenter technical support representative you can call the 900 number. Your local telephone company will bill you by the minute for each call. Persons under age 18 must have permission of a parent or legal guardian prior to placing the call.

United States	1-900-555-HELP(4357)	Monday - Friday 9am to 9pm Eastern Time	\$2.99 (US currency) per minute beginning after the first minute
Canada	1-900-565-9988	24 hours a day	\$3.50 (Canadian currency) per minute after the first minute

Flat rate. You may call the 919 number to purchase support for a single incident or multiple incidents.

Single incident. The single incident option allows you to pay a flat fee for each individual problem you need to resolve. This option is payable only by credit card.

HelpWare support and services

3-incident pack. The 3-incident pack allows you to purchase a block of problem resolutions at a discount from the single incident price. This option is payable only by credit card. The 3-incident pack expires one year from the date of purchase.

10-incident pack. The 10-incident pack allows you to purchase a block of problem resolutions at a discount from the single incident price. This option is payable only by credit card. The 10-incident pack expires one year from the date of purchase.

An incident is a request for telephone assistance about a single question or problem. An incident may involve multiple conversations or actions which may include (but are not limited to):

- your initial request
- research by IBM
- a call back from IBM to you.

Requests for assistance on multiple questions or problems will be considered as multiple incidents.

To order additional support packages.

- In the United States, call **1-919-517-2800**.
- In Canada, call **1-800-565-3344** (excluding holidays).
- Use the following part numbers when you call:

	US Part Number	Canadian Part Number
single incident	2419720	EPCS1
3-incident pack	2419721	EPCS3
10-incident pack	2419722	EPCS10

- In all other countries, contact your IBM reseller or IBM marketing representative.

For more information

The Enhanced PC Support service is available for products on the Supported Products list. To receive a brochure of the Enhanced PC Support service or a Supported Products list from our automated fax system:

- In the United States:

1 Call 1-800-426-3395.

2 Select option 1.

3 Select option 1.

4 Enter one of the following document numbers:

- For a brochure, enter 11690 and press the # key.
- For a supported products list, enter 11682 and press the # key.

5 When you have finished, press 1.

6 Enter your fax number and press the # key.

- In Canada, contact IBM HelpFax:

1 Call 1-800-465-3299.

2 Select appropriate language.

3 Select option 1.

4 Select option 1.

5 Enter one of the following document numbers:

- For a brochure, enter 16129.
- For a supported products list, enter 16130.

6 Follow the instructions given to complete the call.

HelpWare support and services

- In all other countries, contact your IBM reseller or IBM marketing representative.

Express Maintenance

Some countries have "Express Maintenance" which is a parts service that allows IBM HelpCenter personnel to replace selected in-warranty hardware parts and ship them directly to your door. When you receive the part (usually within 3 business days), you can install it in your computer and avoid unnecessary down time. This means you won't have to completely disassemble your computer and take it to an authorized IBM servicer for repair. Some servicers function as drop-off points that may send your system to another location for repair.

When you call for Express Maintenance at 1-919-517-2800, your credit card information will be requested, but it will be discarded if you return the defective part to IBM within 30 days of your receipt of the new part. If the part is not returned within 30 days, your card will be charged the full retail price of the part. Credit card information will not be made available to anyone outside IBM.



Adding and removing hardware

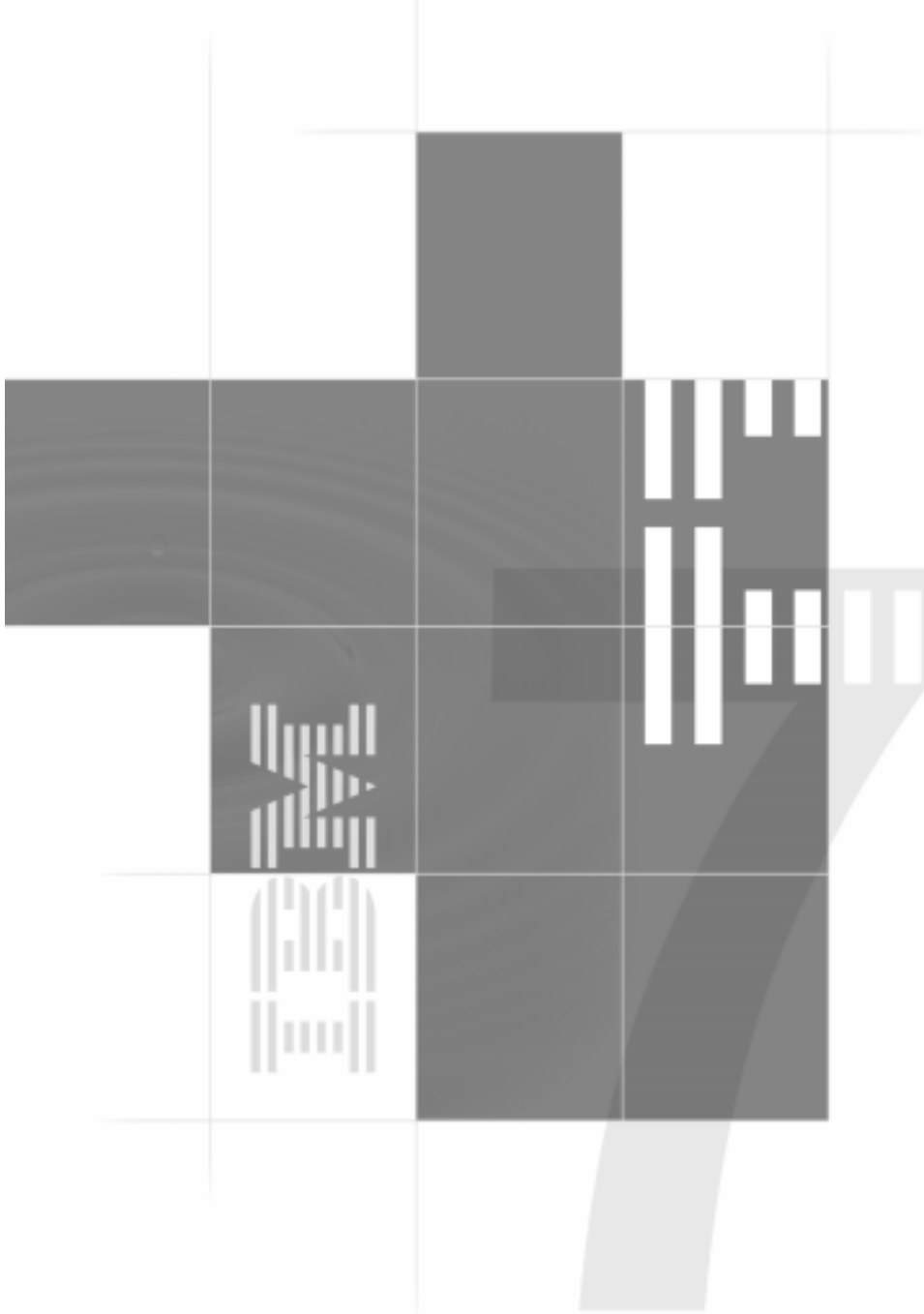



Adding and removing hardware

This chapter contains basic information about:

- adding and removing drives
- identifying system board components.

These instructions do not contain complete information about each option you can install in or remove from your computer.

Your computer came with instructions that are located on the hard disk drive. You can find this information through the *Access Aptiva* area on your Aptiva customized desktop.

If you decide to upgrade or replace any hardware in your computer, you will need to print the instructions for that hardware. See page 24 for the steps to access the Aptiva online help.

Preparing to work with the computer



Danger!

Electrical current from power, telephone, and communications cables is hazardous. To avoid shock hazard, use the steps described in this section to disconnect cables when installing, moving, or opening the cover of this product.

To avoid shock hazard, do not connect or disconnect any cables or perform installation, maintenance, or reconfiguration of this product during an electrical storm.

Before you make any changes to hardware in your computer, you must turn off and unplug the computer.

To disconnect

- 1 Turn off the computer and any attached component which may have its own power switch.
- 2 Unplug all power cables from electrical outlets.
- 3 Remove all signal cables (such as a telephone cord) from their receptacles.
- 4 Disconnect all cables attached to the computer; this includes power cords, input/output cables, and any other cables attached to the computer.

Opening the system unit

- 1 Remove the screws at the back of the system unit.
- 2 Pull the cover back then lift it up to totally detach it from the system unit.

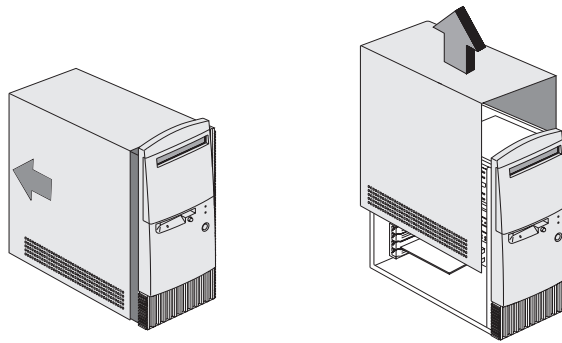

Adding and removing drives

To install a drive in the upper drive bay:

- 1 Remove the bay panel.

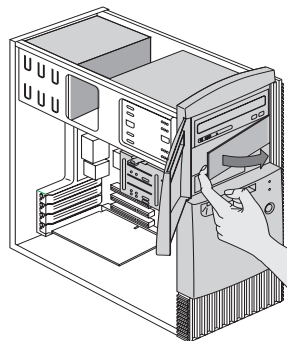

Adding and removing hardware

2 Remove the metal bay cover.

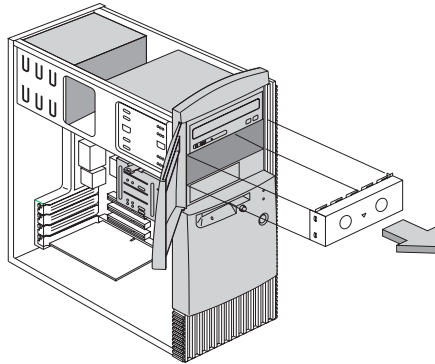

3 Insert a drive into the empty drive bay.

4 Align the screw holes and secure the drive with four screws.

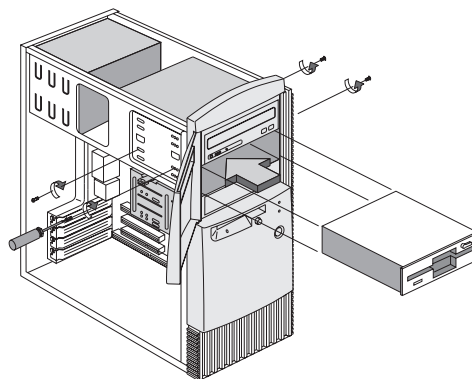

- 5 Connect the power and signal cables.

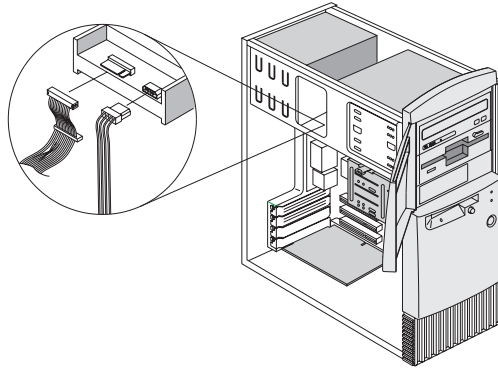

To install a drive in the lower drive bay:

- 1 Remove the 3.5-inch drive bay from the housing by pressing the tab on top and pivoting the drive bay outward.



Note

When installing drives in the lower drive bay, the hard disk drive is always below the 3.5-inch diskette drive.

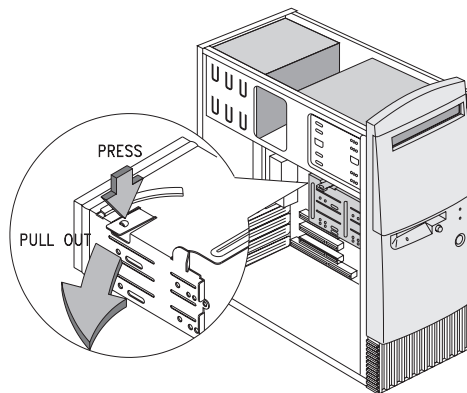

Adding and removing hardware

- 2 Remove the metal bay cover.

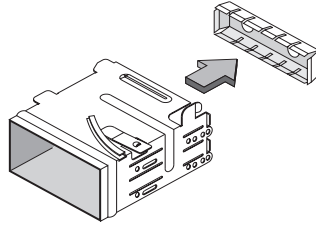

- 3 From the back of the drive bay, carefully insert a 3.5-inch disk drive then secure it with four screws on the sides.

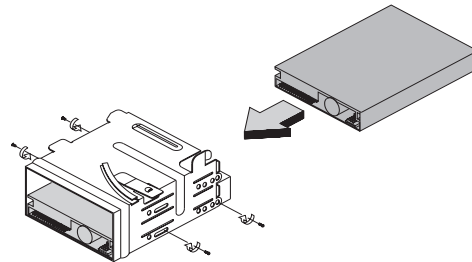

- 4 Re-install the drive bay into the housing as in the following figure:
 - a Align the drive bay with the notch.
 - b Pivot the drive bay toward the housing until the tab clicks into place.

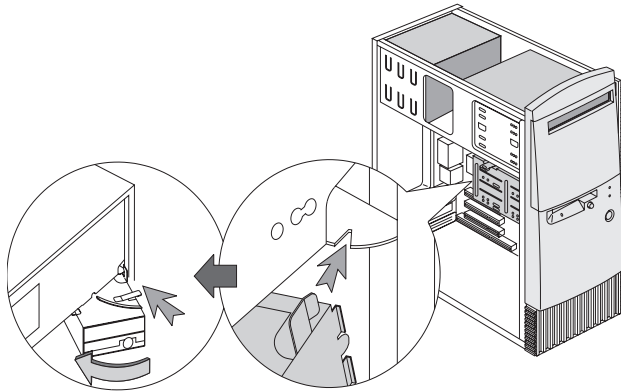

5 Connect the signal and power cables to the drive.

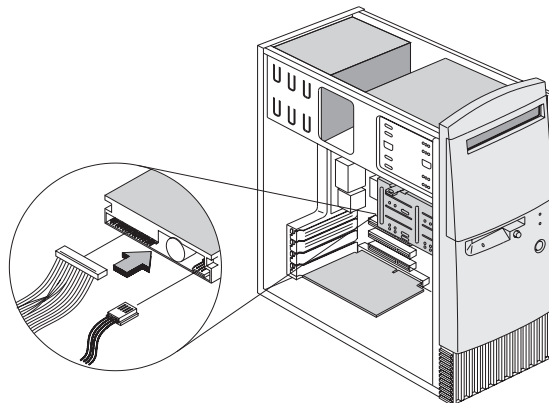

To remove the drive:

To remove a drive from a specific bay, reverse the steps for installing a drive in that bay.

Adding and removing hardware

Identifying system board components

If you decide to upgrade or replace hardware components on your system board, you will need to print the instructions for the hardware. You can find these instructions in the *Aptiva Helps* on the hard disk drive.

The system comes with two types of system boards. Refer to the figure that looks like the system board that came with your system. Each figure is followed by a list of labeled components and their corresponding functions.

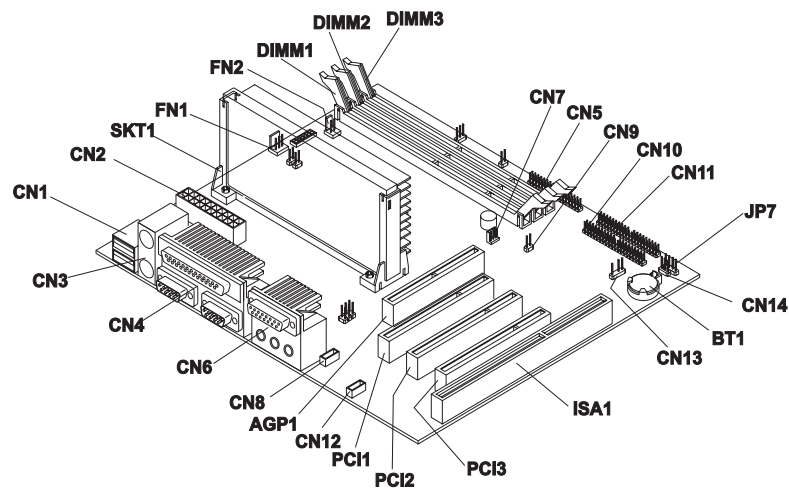

Number	Description	Number	Description
AGP 1	AGP video card connector	CN11	Primary IDE connector
BT1	System battery	CN12	Fax modem connector
CN1	USB connectors	CN13	Modem ring-in connector
CN2	ATX power supply connector	CN14	IDE LED connector
CN3	PS/2 mouse and keyboard connectors	DIMM 1, DIMM 2, DIMM 3	System memory module sockets
CN4	Parallel, serial 1 and serial 2 connectors Note: If a serial device does not worked when plugged into serial 1, the port may be disabled. Use the Setup Utility to enable serial port 1.	FN1	3-pin processor fan connector
CN5	Diskette drive connector	FN2	2-pin processor fan connector
CN6	MIDI, line-in, line-out and mic-in connectors	ISA 1	ISA adapter card connector
CN7	Wake-on LAN connector	JP7	Power LED connector

Adding and removing hardware

Number	Description	Number	Description
CN8	CD-ROM audio connector	PCI 1, PCI 2, PCI 3	PCI adapter card connectors
CN9	Power button connector	SKT1	Processor
CN10	Secondary IDE connector		

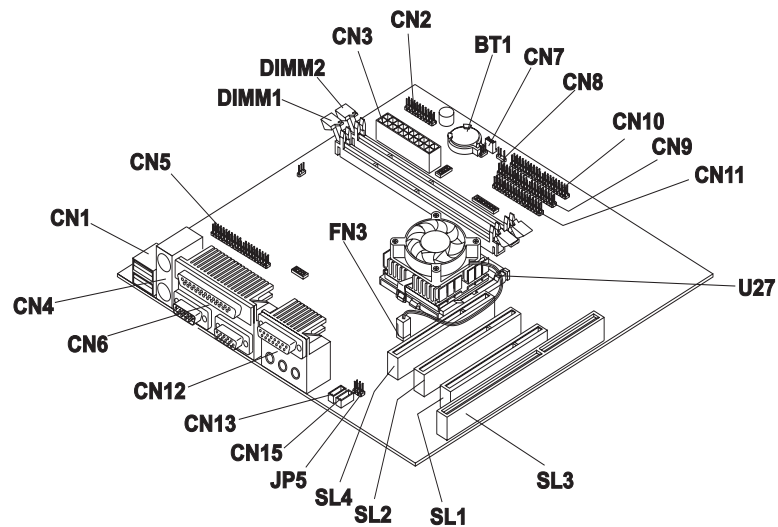

Number	Description	Number	Description
BT1	System battery	CN11	Diskette drive connector
CN1	USB connectors	CN12	Joystick/MIDI, line-in, line-out, and mic-in connectors
CN2	Power button, reset, hard disk, power, suspend LEDs, and Infrared connectors	CN13	Fax, voice, modem connector
CN3	ATX power connector	CN15	CD-ROM audio in connector
CN4	PS/2 mouse and keyboard connectors	DIMM 1, DIMM 2	System memory module sockets
CN5	ATI Multimedia Channel (AMC) feature connector	FN3	2-pin processor fan connector
CN6	Parallel, serial, and VGA connectors	JP5	Passive speakers/ Powered speakers jumper. See the "Installing amplified speakers" topic in the Aptiva online help for steps to change this jumper.

Adding and removing hardware

Number	Description	Number	Description
CN7	Wake-on LAN connector	SL1, SL2, SL4	PCI adapter card connectors. See the "System board components" topic in the Aptiva online help for the maximum allowable size of adapter cards.
CN8	Modem ring-in connector	SL3	ISA adapter card connector
CN9	Primary IDE connector	U27	Processor
CN10	Secondary IDE connector		



Index

A

- adding and removing
 - hardware 99
- Aptiva Helps and
 - software 21–28
- Aptiva Installer 28
- Aptiva online help 24
- arrange work area 17
- audio
 - solving problems 42, 54
- AutoPlay 27, 42

B

- batteries 6
- battery
 - disposal 6
 - handling 6
- BIOS
 - Setup Utility updates 73

C

- CD-ROM
 - handling discs 26
- CD-ROM drive
 - audio disc
 - problems 42, 54
 - safety information 8
 - where to find. See "Hardware" topics in Aptiva online help

- contact IBM HelpCenter 87

D

- diagnosing problems. See topic in Aptiva online help
- drives, adding and removing 100
- DVD 26
 - solving problems 58

E

- ergonomics 17, 19
 - chair 18
 - keyboard position 19
 - monitor position 18
 - mouse position 19
- error codes 59–68
- express maintenance 95

G

- getting help 83, 95

H

- handling CDs and DVDs 26
- hardware
 - adding and removing 99–108
 - configuration 73
 - solving hardware problems 38

- specifications. See "System Information" topic in Aptiva online help
- testing. See "diagnosing problems"

- hardware problems
 - HelpWare service and support 83–95

- help 84

- 30-day "Up and Running" support 88

- Aptiva Helps 24–25

- electronic 86

- hardware 88

- internet 84

- readme files 25

- software 88

- telephone 84, 87

- troubleshooting steps 70

- HelpWare 81–95

- 30-day "Up and Running" support 88

- additional support 88

- automated fax 87

- definition 83, 95

- electronic support 86

- hardware service 88

- online documentation 84

Index

- printed
 - documentation 84
 - purchasing additional services 91
 - quick help 84
 - software support 88
- How Do I... 23
- I**
- information
 - installing and replacing hardware 26
 - readme files 25
 - installing programs 27–28
 - internet 84
- K**
- keyboard
 - positioning 19
 - solving problems 43
- L**
- laser product safety information 8
- M**
- modem
 - solving problems 54
- where to find. See "Hardware" topics in Aptiva online help
- monitor
 - positioning 18
 - solving problems 51
- multimedia
 - solving problems 54–57
- N**
- notices 3
- O**
- online information
 - online helps
 - readme files 25
- online information and software
 - handling CDs and DVDs 26
 - installing and replacing hardware 26
 - installing programs 27, 28
- opening the system unit 100
- P**
- power button switch 33
- power button. See "Getting Started" topics in Aptiva online help
- problems
 - audio, multimedia, and modem 54–57
 - can't use second modem 57
 - modem not detected 56
 - no modem dial tone 57
 - no sound 54
 - beeps 38
 - diagnosing 31
 - DVD 58
 - error codes 59–68
 - hardware 38–47
 - blank screen 38
 - computer appears to have turned off without warning 38
 - drives 39–42
 - error code 38
 - keyboard 43
 - modem 45
 - mouse 44
 - printer 46
- monitor 51–53
 - adjustments 53
 - blank screen 53
 - cursor only displayed 53

Index

- discolored
 - screen 51
 - flicker 52
 - fonts 52
 - no cursor 53
 - poor picture
 - shape 51
 - unreadable
 - screen 53
 - unsteady
 - picture 52
 - white screen 52
 - yellow, cyan, magenta
 - screen 52
 - questions to ask
 - first 33
 - beeps 34, 47
 - monitor 35–37
 - power lights 33
 - recovering factory
 - installed programs and files 69
 - software 48–49
 - computer doesn't turn off 50
 - suspend 48
 - troubleshooting
 - steps 29–70
- R**
- Readme files 25
 - recovering factory installed
 - programs 69
 - regulatory notices 10
- EU conformance
 - statement 13
 - FCC and telephone
 - company 10
 - statement 11
 - replacement parts safety
 - information 6
- S**
- safety information 6–9
 - CD-ROM and DVD-ROM drive 8–9
 - connecting your computer 7
 - DVD-ROM drive 8–9
 - grounding your computer 6
 - laser product 8
 - lithium batteries 6
 - protecting against electrical shock 6
 - replacement parts 6
 - telephone
 - connection 6
 - service and support 83, 95
 - setting up your
 - computer 17–19
 - chair 18
 - keyboard position 19
 - monitor position 18
 - mouse position 19
 - setup utility 71–80
 - changing settings 78
 - exiting 79
 - loading default 78
 - Main Menu 76
 - starting 74
 - using 73
 - viewing system
 - information 78
 - working with 77
- software
- installing
 - programs 27
 - solving problems 48
- support 83, 95
- electronic 86
 - internet 84
 - telephone 84, 87
- system board
- identifying
 - components 105–108
- system information. See topic in Aptiva online help
- T**
- telephone support 84, 87
 - trademarks 3
 - troubleshooting 29–70
 - audio, multimedia, and modem
 - problems 54–57
 - can't use second
 - modem 57
 - modem not
 - detected 56
 - no modem dial
 - tone 57

- no sound 54
- diagnosing and recovering from problems 31
- DVD problems 58
- error codes 59–68
 - 111 I/O parity error 59
 - 1162 onboard serial port conflict(s) 63
 - 127 CPU clock mismatch 59
 - 151/163 real time clock error 59
 - 161 CMOS battery bad 60
 - 162 CMOS checksum error 59, 60
 - 162 equipment configuration error 60
 - 164 memory size changed 60
 - 1755 hard disk drive(s) write protected 63
 - 1762 onboard secondary IDE channel I/O address conflict(s) 64
 - 178 IDE primary slave drive error 65
 - 1780 IDE primary channel master drive error 64
 - 1782 IDE secondary channel master drive error 65
 - 1783 IDE secondary channel slave drive error 66
 - 1800 IRQ setting error/PnP ISA card(s) disabled 66
 - 1801 expansion ROM allocation failed 66
 - 1802 I/O resource conflict(s) 67
 - 1803 memory resource conflict(s) 67
 - 1962 insert system diskette and press to reboot message 68
 - 201 memory error 61
 - 301 PS/2 keyboard error 61
 - 303 PS/2 Keyboard Interface Error 61
 - 648 floppy drive(s) write protected 61
 - 662 floppy disk controller error 62
 - 662 floppy drive error 62
 - 662 onboard floppy drive errors 62
 - 8601/8603 PS/2 pointing device error 68
 - 962 onboard parallel port conflict(s) 63
- beep 59
- NMI 59
- hardware
 - problems 38–47
 - beeps 38
 - blank screen 38
 - computer appears to have turned off without warning 38
 - drives 39–42
 - error code 38
 - keyboard 43
 - modem 45
 - mouse 44
 - printer 46
- monitor
 - problems 51–53
 - adjustments 53

Index

- blank screen 53
 - cursor only
 - displayed 53
 - discolored screen 51
 - flicker 52
 - fonts 52
 - no cursor 53
 - poor picture
 - shape 51
 - unreadable screen 53
 - unsteady picture 52
 - white screen 52
 - yellow, cyan, magenta screen 52
 - questions to ask
 - first 33
 - beeps 34, 47
 - monitor 35–37
 - power lights 33
 - recovering factory installed programs and files 69
 - software
 - computer doesn't turn off 50
 - suspend 48
 - software problems 48–49
- U**
- Update Connector 28, 85
- Y**
- Year 2000. See topic in Aptiva online help